

AGASTAT 2100 Series, Miniature Electropneumatic Timing Relay



Product Facts

- **High Repeat Accuracy over voltage and temperature extremes**
- **Hermetically sealed units are designed for high shock and vibration applications**
- **Instant recycling — easy linear adjustment**
- **Exclusive Dial Head adjustment — no needle valves**
- **Delay ranges from milliseconds to 3 minutes**
- **DPDT contacts**

Design & Construction

Sealed patented timing head — circulates air under controlled pressure through a variable orifice to provide adjustable timing. Circular-path Dial Head principle replaces traditional needle valve.

Snap-action switch assembly — provides sustained contact pressure during timing cycles. Specially designed over center mechanism assures flutter-free load transfer after extended delay periods.

Precision-wound solenoid assembly — supplies the basic motive force when the control circuit is closed.

These assemblies are mounted in a rigid self-supporting framework within a steel enclosure. This rugged construction assures permanent alignment of all operating members, the key to this unit's long trouble-free operation.

Users should thoroughly review the technical data before selecting a product part number. It is recommended that users also seek out the pertinent approvals files of the agencies/laboratories and review them to ensure the product meets the requirements for a given application.



Operation

Series 2112 (On-Delay)

Applying rated voltage to the solenoid coil starts the preset time delay. At the end of the delay period the NC contacts break and the NO contacts make. Contacts remain in this position until the coil is de-energized, when the switch instantaneously returns to its original position. De-energizing the coil, either during or after the delay period, will immediately (within 25 msec.) recycle the unit. It will then provide another full delay period on re-energization.

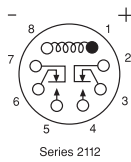

Series 2122 (Off-Delay)

Applying rated voltage to the coil for at least 75 msec. (for accurate timing) will instantaneously transfer the switch, breaking the NC contacts and making the NO contacts. Contacts remain in this position as long as the coil is energized. The preset time delay period begins as soon as the coil is de-energized, at the end of which the switch returns to its original position. **No power is required during the timing period.** Re-energizing the coil, either during or after the delay period, will immediately start a new cycle with full delay period.

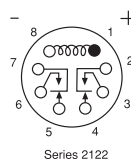

Operation (Listed values at nom. voltage, 25°C unless noted)

Operating Mode

2112 — On-delay (delay on pull-in); **2122** — Off-delay (delay on drop-out)

Timing Adjustment — All standard models offer easy linear adjustment over one of nine timing ranges listed below. For applications requiring frequent readjustment, the external knob model is recommended. For tamper-proof installation or where readjustment is infrequent, the internal key model may be preferred. This model requires removal of the cover plate for timing adjustment. Hermetically sealed models provide a slotted adjusting screw under the cap nut on the top cover.

Timing Ranges

Code	Range
A	.03 to .1 sec.
B	.1 to .3 sec.
C	.15 to 1.0 sec.
D	.375 to 3.0 sec.
E	.75 to 10.0 sec.
F	1.0 to 30.0 sec.
G	2.0 to 60.0 sec.
H	5.0 to 120.0 sec.
J	5.0 to 180.0 sec.
K	1.5 to 30.0 cycles
L	3.0 to 120.0 cycles

Repeat Accuracy — NORMAL VERTICAL POSITION

±5% at 25°C; ±7% at 85°C; ±8% at -55°C.

The average time between -55°C and 85°C will be within ±20% of the average @ 25°C with a proportionally reduced effect at lesser extremes.

In extremely short delay settings an additional 8 msec. variation may result on AC models due to "half cycle" alternating current effect.

Setting Tolerance — Factory time setting, when specified, subject to additional +5% tolerance.

Position Sensitivity

HORIZONTAL POSITION — Approximately 5% increase from the initial time in the vertical position.

INVERTED POSITION — Approximately 10% increase from the initial time in the vertical position.

Reset Time — 2112 Series: 25 msec.; 2122 Series: 75 msec.

Relay Release Time — 25 msec. (2112 Series)

Relay Operate Time — 75 msec. (2122 Series)

Operating Voltage — Coil Data

Code	Nominal Operating Voltage	Resistance Ohms ±10%
M	12VDC	30
N	28VDC	131
P	48VDC	500
R	110VDC	3200
S	120V 60 Hz	190 (2112 Series)
S	120V 60Hz	285 (2122 Series)
T	240V 60Hz	765
U	115V 400Hz	2600
Y	125VDC	3380

Transients — Insensitive to transients of ±1500 VAC for 10 milliseconds

Dielectric — 1000V RMS @ 60Hz between non-connected terminals.

Contact Rating (DPDT Contacts) —

	30V DC	110V DC	120V 60Hz	120V 400Hz	240V 60Hz
Inductive (Amps)	2	.75	3	2	1.5
Resistive (Amps)	10	1	10	10	5

Based on 100,000 operations electrical, 1,000,000 mechanical. Inductive and capacitive load should not have inrush currents that exceed five times normal operating load.

Ambient Temperature Range — -55°C to +85°C

Weight — Maximum, any unit - 17 ozs.

Mounting/Terminals — Chassis mounting tabs, octal plugs and external (-4) or internal (-5) adjustment. Panel mounting back plate, internal adjustment, and solder hook terminals (-9).



These are minimum standards; where more severe environmental conditions must be met, please consult the factory.

AGASTAT 2100 Series, Miniature Electropneumatic Timing Relay (Continued)

Outline Dimensions for Industrial Models (Dimensions in inches. Multiply by 25.4 to obtain millimeters.)

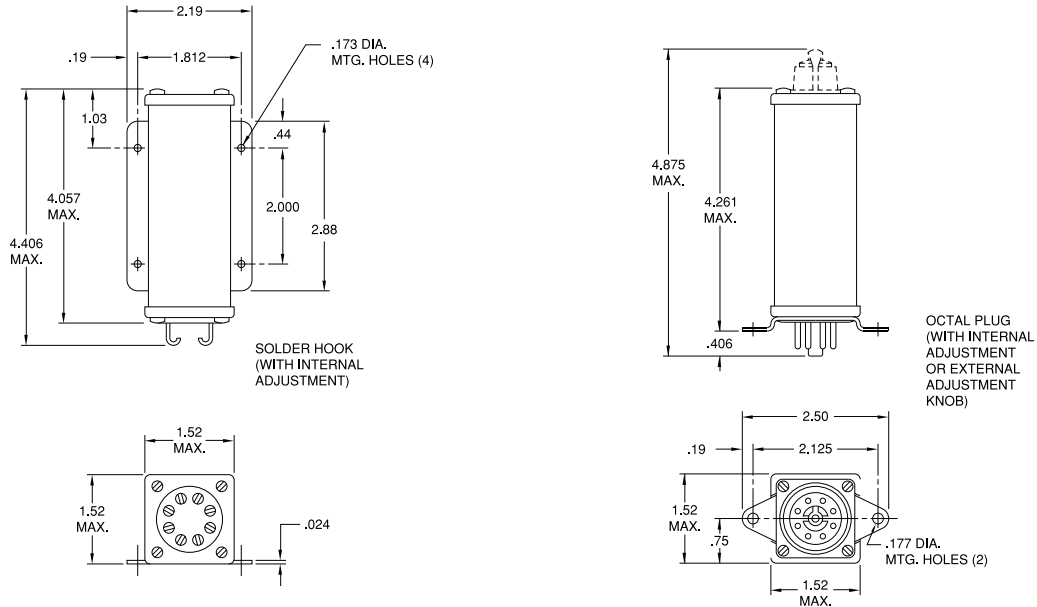

Ordering Information for Industrial Models

Typical Part No. ▶		21	1	2	D	4	N	B
1. Basic Series: 21 = 2100 Miniature electropneumatic timing relay								
2. Operation: 1 = On-delay 2 = Off-delay								
3. Contact Arrangement: 2 = DPDT (2 form C)								
4. Operating Voltage: A = AC D = DC								
5. Physical Characteristics:								
Code	Enclosure	Adjustment	Connector	Mounting				
4 =	Unsealed	External Knob	Octal Plug	Chassis Mount				
5 =	Unsealed	Internal Key	Octal Plug	Chassis Mount				
9 =	Unsealed	Internal Key	Solder Hook	Panel Mount Plate				
6. Coil Voltage:								
M = 12VDC	N = 28VDC	P = 48VDC	R = 110VDC	Y = 125VDC				
S = 120VAC, 50/60 Hz.	T = 240VAC, 60 Hz.							
7. Timing Range:								
A = .03 to .1 sec.	C = .15 to 1.0 sec.	E = .75 to 10.0 sec.	H = 5.0 to 120.0 sec.	K = 1.5 to 30.0 cycles				
B = .1 to .3 sec.	D = .375 to 3.0 sec.	F = 1.0 to 30.0 sec.	J = 5.0 to 180.0 sec.	L = 3.0 to 120.0 cycles				

Our authorized distributors are more likely to maintain the following items in stock for immediate delivery.

None at present.

12

Specialty Relays

AGASTAT 2100 Series, Miniature Electropneumatic Timing Relay (Continued)

Specifications for Hermetically Sealed Models



Dielectric — Withstands 1,000 Volts RMS at 60 Hz between non-connected terminals.

Other — AGASTAT Miniature Timing Relays also conform to applicable requirements covering:

- | | |
|------------|-------------------|
| Moisture | Ozone |
| Humidity | Sunshine |
| Sand/Dust | Acoustic Noise |
| Salt Spray | Prolonged Storage |

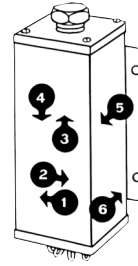

Outline Dimensions for Hermetically Sealed Models (In inches. Multiply by 25.4 for millimeters.)

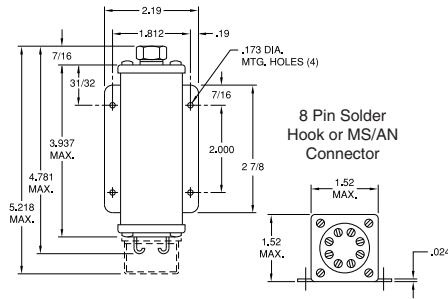

**Panel Mount
-H1, -H3**

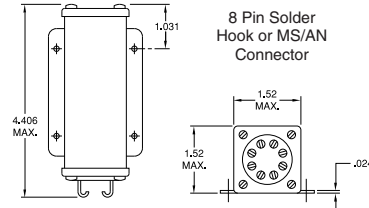

**Panel Mount
-9**

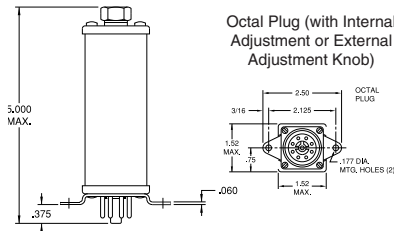

**Chassis Mount
-H2**

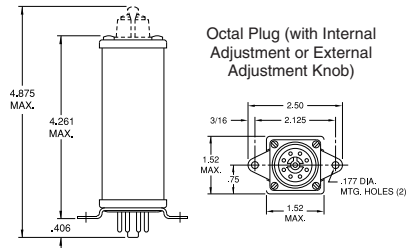

**Chassis Mount
-4, -5**

AGASTAT 2100 Series, Miniature Electropneumatic Timing Relay (Continued)

Ordering Information for Hermetically Sealed & Unsealed Models

Typical Part No. ►					21	1	2	D	H1	N	B
1. Basic Series: 21 = 2100 Miniature electropneumatic timing relay											
2. Operation: 1 = On-delay 2 = Off-delay											
3. Contact Arrangement: 2 = DPDT (2 form C)											
4. Operating Voltage: A = AC D = DC											
5. Physical Characteristics:											
Code	Enclosure	Adjustment	Connector	Mounting							
H1 =	Hermetically Sealed	External Screw	Solder Hook	Panel Mount Plate							
H2 =	Hermetically Sealed	External Screw	Octal Plug	Chassis Mount							
H3 =	Hermetically Sealed	External Screw	"AN" Connector	Panel Mount Plate							
4 =	Unsealed	External Knob	Octal Plug	Chassis Mount							
5 =	Unsealed	Internal Key	Octal Plug	Chassis Mount							
9 =	Unsealed	Internal Key	Solder Hook	Panel Mount Plate							
6. Coil Voltage:											
M = 12VDC	N = 28VDC	P = 48VDC	R = 110VDC	Y = 125VDC							
S = 120VAC, 50/60 Hz.	T = 240VAC, 60 Hz.	U = 115VAC, 400 Hz.									
7. Timing Range:											
A = .03 to .1 sec.	C = .15 to 1.0 sec.	E = .75 to 10.0 sec.	H = 5.0 to 120.0 sec.	K = 1.5 to 30.0 cycles							
B = .1 to .3 sec.	D = .375 to 3.0 sec.	F = 1.0 to 30.0 sec.	J = 5.0 to 180.0 sec.	L = 3.0 to 120.0 cycles							

Our authorized distributors are more likely to maintain the following items in stock for immediate delivery.

None at present.

12

Specialty Relays

X-ON Electronics

Largest Supplier of Electrical and Electronic Components

Click to view similar products for [Time Delay & Timing Relays](#) category:

Click to view products by [TE Connectivity](#) manufacturer:

Other Similar products are found below :

[7012GD](#) [7012L10BN](#) [7012L10DY1N](#) [7012L10FN](#) [7012L10HN](#) [7012L26K](#) [7012L8AI2LLSN](#) [7012L8BN](#) [7012L8KN](#) [7012OBILM](#)
[7012OIT](#) [7012PALL](#) [7012PDM](#) [7012PFX](#) [7022L10DN](#) [7022L8BN](#) [7022L8EN](#) [7022L8HN](#) [7022X3D](#) [7024NB](#) [7024SCT](#) [88256455](#) [H3BG-](#)
[N8H](#) [AC110V](#) [H3CRF8AC2448DC1248](#) [1423151-3](#) [1423154-8](#) [1423462-7](#) [1423618-6](#) [1423151-5](#) [1423156-7](#) [1423618-4](#) [2112AH1SDC947](#)
[2122DH1NJC467](#) [2122DH1PE](#) [2-1617805-2](#) [2-1617805-6](#) [K61C-08](#) [286XCXC-300-24D](#) [SCBRX022XXACXAC991](#) [SHS10S110A](#)
[SHS20M220A](#) [1755074-5](#) [SSC12AKA](#) [FAASPRING2](#) [2112DH3NDC50-13](#) [2122DH34NDC629](#) [2-1437479-8](#) [2-1617805-1](#) [2-1617805-3](#) [2-](#)
[1617805-7](#)