

Amphenol







C 16-1 / C 16-3



Circular
Circular Connectors



Amphenol-Tuchel Electronics



Shell size 1				
No. of contacts	8 + PE	14 + PE	17 + PE	
Termination	crimp	crimp	crimp	
Wire gauge mm ² / AWG	0,14 - 2,5 / 26 - 14	0,14 - 2,5 / 26 - 14	0,14 - 1,0 / 26 - 18	
Rated insulation voltage	400 V	100 V	100 V	
Current carrying cap.	12 A	11 x 6 A; 4 x 18 A	6 A	
Pollution degree	3	3	3	
Installation category	III	III	III	
Protection class	IP 65	IP 65	IP 65	
Shell size 2				
No. of contacts	5 + PE	12 + PE	14 + PE	19 + PE
Termination	screw	crimp	crimp	crimp
Wire gauge mm ² / AWG	4 / 10	0,14 - 2,5 / 26 - 14	0,14 - 2,5 / 26 - 14	0,14 - 1,0 / 26 - 18
Rated insulation voltage	400 V	3 x 500 V; 9 x 300 V	400 V	250 V
Current carrying cap.	21 A	3 x 21 A; 9 x 11 A	4 x 6 A; 11 x 12 A	6 A
Pollution degree	3	3	3	3
Installation category	III	III	III	III
Protection class	IP 65	IP 65	IP 65	IP 65

C 16-3

Product description
Order information
Approvals

Product description	Order information	
<p>The circular connector series C 16-3 has two housing sizes. The connectors are designed to meet the high requirements of industrial applications under harsh environmental conditions. The range includes versions with screw and crimp terminations. A selection of crimp contacts for hand crimp tools and crimp machines enables a reliable termination resulting in qualitative, technical and economical advantages. A broad selection of housing styles are available.</p> <p>Main features and advantages:</p> <ul style="list-style-type: none"> • Circular connectors for power and signal applications with following contact arrangements: Shell size 1: 8 + PE, 14 + PE, 17 + PE Shell size 2: 5 + PE, 12 + PE, 14 + PE, 19 + PE • For applications in machine tools, measurement and control, process technology and medical equipment • Housing are made from high grade plastic material. • Vibration safe connection by solid bayonet coupling with lock in position. • Cable housing straight and right-angled with various cable outlets • Protection degree IP 65 per IEC 60529 in mated condition. • Internal strain relief with screw clamp or concentric strain relief provides a safe cable restrain. 	<p>Color coding Upon request the coupling ring of the plugs and the housings of the receptacles can be delivered in the color red, green, blue, yellow and grey.</p> <p>Polarization Depending on the contact arrangements the polarization of this connector series can be varied. The contact inserts can be mounted in alternate positions. The order number in the catalog refers always to position 1. The position of the contact inserts can also be changed by the customer using a disassembly tool (see page 26 and 29) to remove the insert and remount it in the required position (see page 19).</p> <p>Crimp version Order numbers do not include crimp contacts. Please order separately (page 30/31). Crimp contacts for higher currents (up to 16A) are available upon request.</p> <p>Crimp tooling Ask for our crimp tooling catalogs.</p>	
Testhouse	Approvals	Approval No.
VDE		3964
UL		E 63093
CSA		49932-9

C 16-3

Coding system

Polarization

Depending on the contact arrangements the polarization of this connector series can be varied. Please take care of the housing and contact insert characteristics.

Shell size 1			Shell size 2		
No of contacts	No of coding possibil.	Position	No of contacts	No of coding possibil.	Position
8 + PE	4	1, 3, 5, 7	5 + PE	6	1, 2, 3, 4, 6, 7
14 + PE	7	1, 2, 3, 4, 5, 6, 7	14 + PE	7	1, 2, 3, 4, 5, 6, 7
17 + PE	6	1, 2, 3, 4, 5, 7	12 + PE	7	1, 2, 3, 4, 5, 6, 7
			19 + PE	6	1, 3, 4, 5, 6, 7

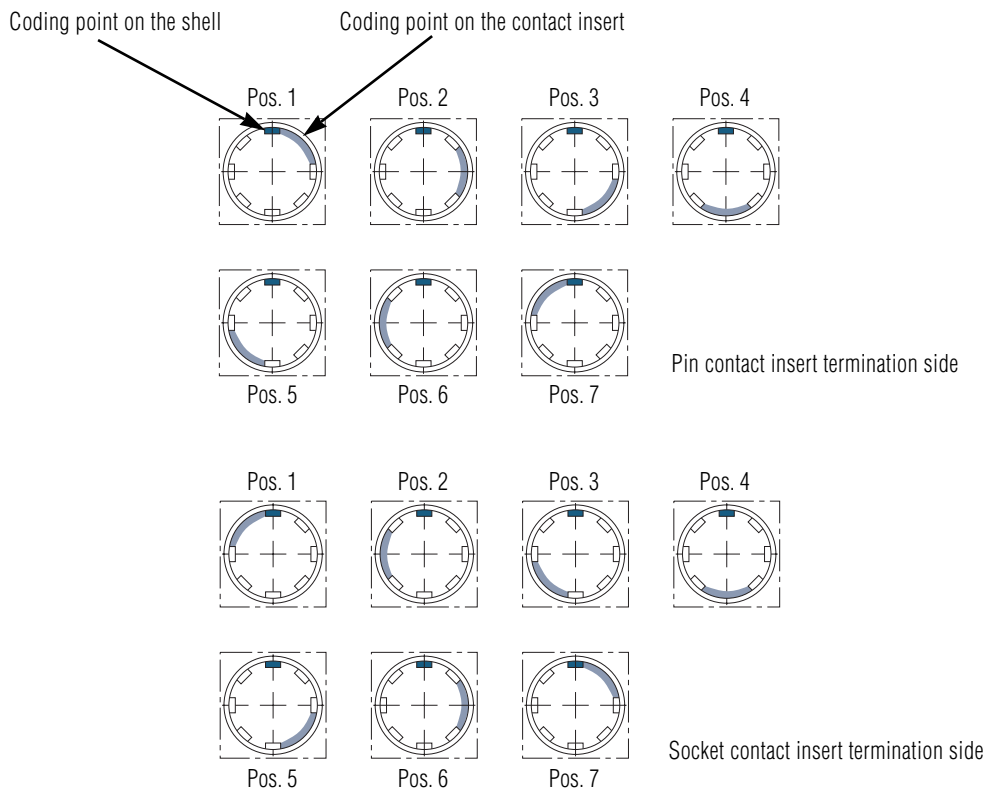

Disassembly of contact inserts with disassembly tool (see page 26 und 29)

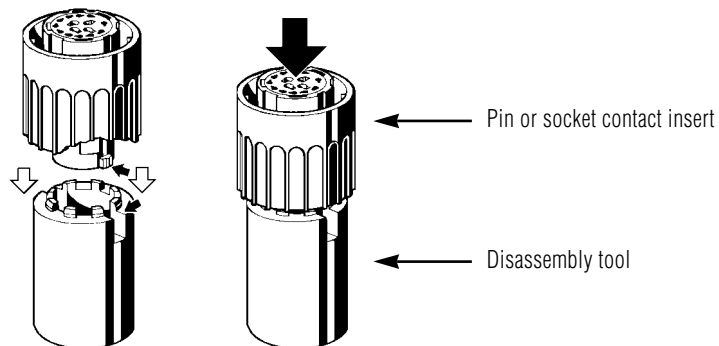

C 16-3

Characteristics

General Characteristics	Standard	Characteristics						
		Shell size 1			Shell size 2			
Number of contacts		8 + PE	14 + PE	17 + PE	5 + PE	12 + PE	14 + PE	19 + PE
Electrical Characteristics								
Rated insulation voltage	IEC 60664-1	400 V	100 V	100 V	400 V	3 x 500 V 9 x 300 V	400 V	250 V
Rated impulse withstand voltage	IEC 60664-1	6000 V	3000 V	3000 V	6000 V	3 x 6000 V 9 x 4000 V	3110 V	4000 V
Pollution degree	IEC 60664-1	3	3	3	3	3	3	3
Installation (overvoltage) category	IEC 60664-1	III	III	III	III	III	III	III
Material group	IEC 60664-1	II	II	II	II	II	II	II
Test voltage	IEC 60664-1	3110 V	1680 V	1680 V	2900 V	3 x 2900 V 9 x 1960 V	3110 V	1960 V
Current carrying capacity	IEC 60512-3, Test 5b	12 A	11 x 6 A 4 x 18 A	6 A	21 A	3 x 21 A 9 x 11 A	4 x 6 A 11 x 12 A	6 A
Insulation resistance	IEC 60512-2, Test 3a	≥ 10 ⁸ Ω						
Contact resistance	IEC 60512-2, Test 2a	≤ 5 mΩ						
Climatical Characteristics								
Climatic category	IEC 6068-1	40 / 125 / 56			40 / 100 / 56	40 / 125 / 56		
Operating temperature		-40°C ... +125°C (5+PE: +100°C) / -40°F ... +265°F (5+PE: +212°F)						
Mechanical Characteristics								
IP-degree of protection	IEC 60529	IP 65						
Insertion and withdrawal force	IEC 60512-7, Test 13b	≤ 25 N	≤ 30 N	≤ 22 N	≤ 15 N	≤ 25 N	≤ 30 N	≤ 25 N
Mechanical operation	IEC 60512-5, Test 9a	≥ 500 mating cycles						
Materials								
Housing material		Polyamid 6.6						
Dielectric material		Polyamid 6.6						
Gasket material		Neoprene						
Contact plating		silver plated / gold plated						
Other Characteristics								
Termination technique		crimp			screw	crimp		
Wire range mm ² / AWG		0,14 - 1,5 / 26 - 16	0,14 - 2,5 / 26 - 14	0,14 - 1,0 / 26 - 18	4 / 10	0,14 - 2,5 / 26 - 14	0,14 - 2,5 / 26 - 14	0,14 - 1,0 / 26 - 18
Flammability		UL 94 VO						
Locking system		bayonet						



The stated technical values refer to the use as connector.

If these components are used as plug and socket device a reduced current carrying capacity has to be considered.

C 16-3

Derating curves

Shell size 1

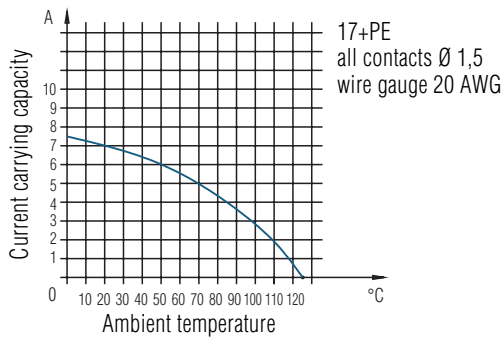
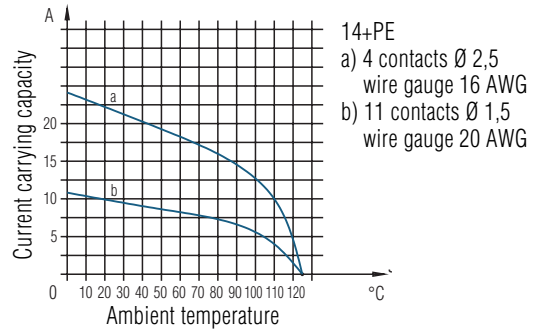
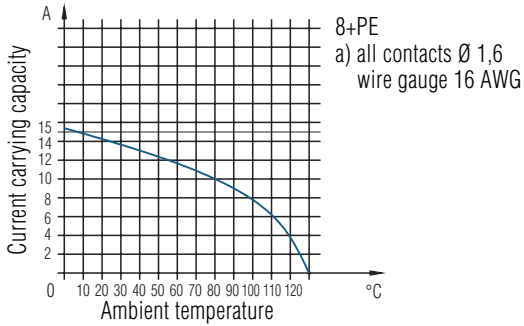



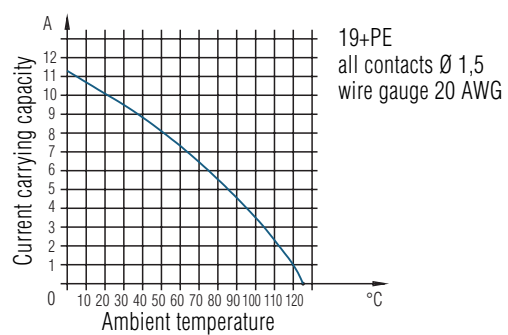
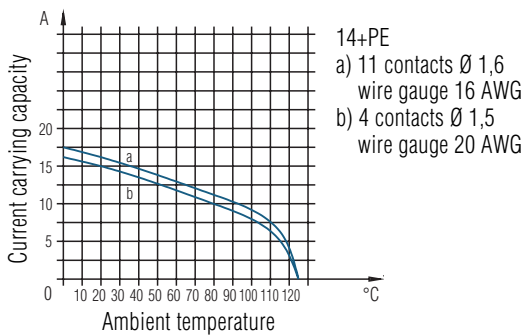
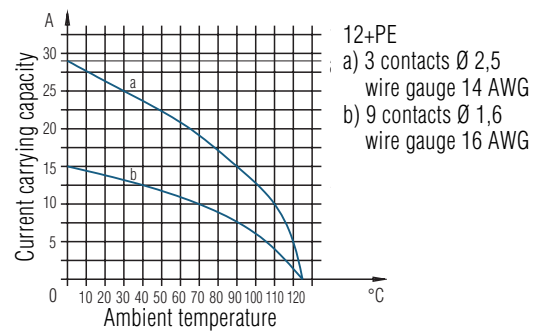
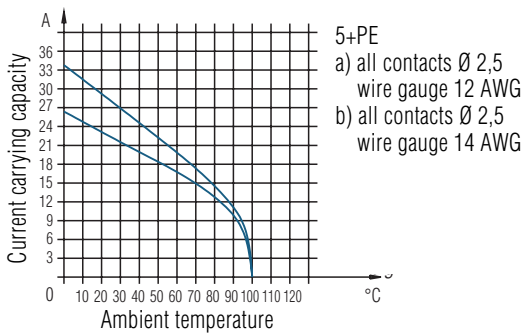

Shell size 2



C 16-3

View of connector style,
Shell size 1 and 2

Identification	Figure	Description	Conn. Style	Page	
				Size 1	Size 2
Male cable connector		Long version with internal strain relief	I	24	27
		Short version, with clamping ring	H	24	27
		Right-angled, with clamping ring	K	24	27
Female cable connector		Long version with internal strain relief	E	25	28
		Short version, with clamping ring	D	25	28
		Right-angled, with clamping ring	F	25	28
Female receptacle		Flange mounting, with mounted gasket	G	25	27
		Panel mounting with ring nut, with gasket	N	25	–
Male receptacle		Flange mounting, with mounted gasket	C	26	28

C 16-3

Mounting instruction

Torque
min. 1 Nm
max. 2 Nm

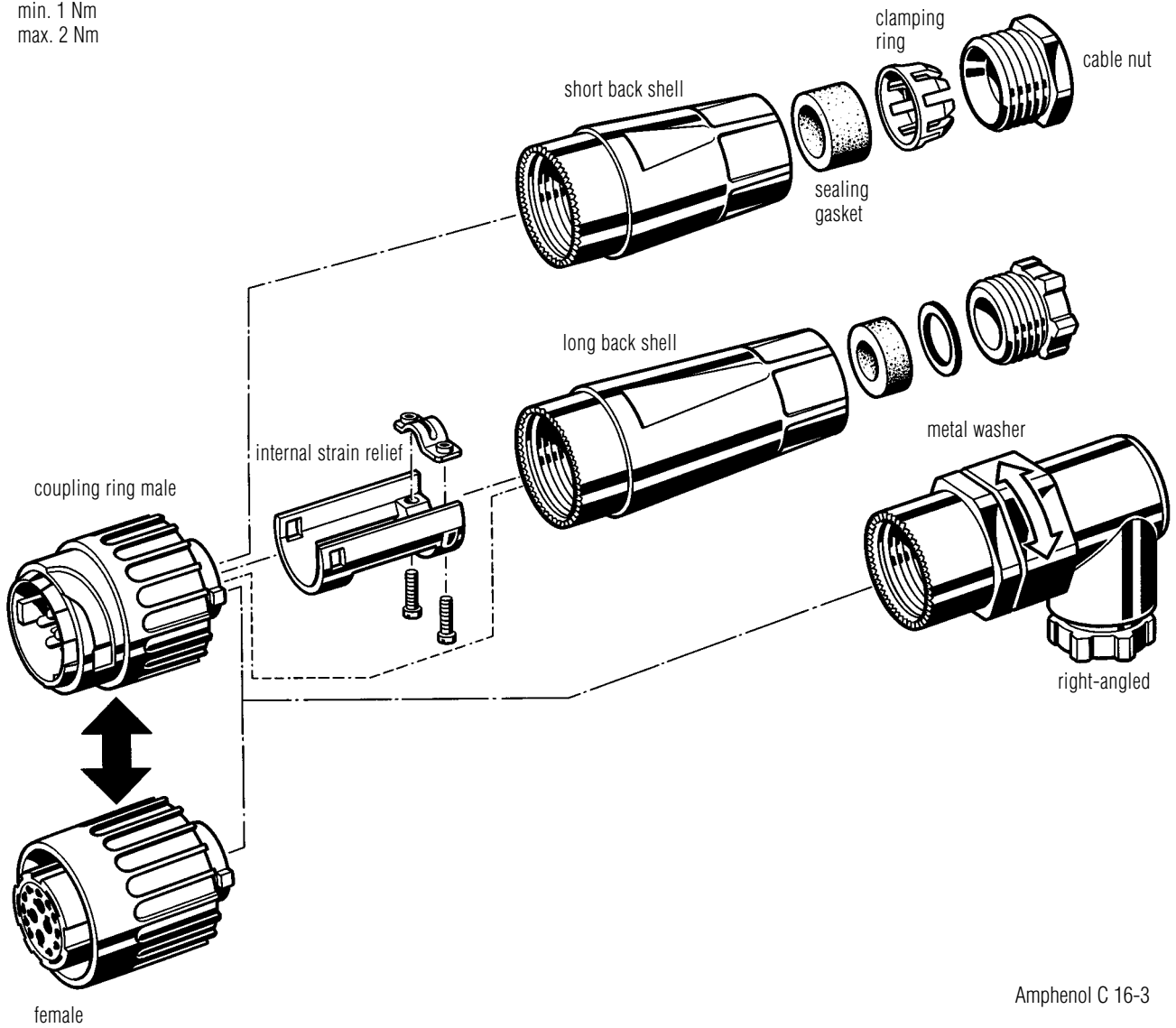

C 16-3

Shell size 1
Male cable connectors



I



H



K

Description	Drawing	No. of cont.	Contacts ²⁾	Part No. Cable outlet ³⁾	
				PG 11	PG 13,5
Male cable connector, long, style I with internal strain relief, without contacts ¹⁾		8 + PE	.N 01 016 00...	C016 10I008 002 1	C016 10I008 003 1
		14 + PE	11 x .N 01 015 00... 4 x .N 01 025 00...	C016 10I014 002 1	C016 10I014 003 1
		17 + PE	.N 01 015 00...	C016 10I017 002 1	C016 10I017 003 1
Male cable connector, short, style H with clamping ring, without contacts ¹⁾		8 + PE	.N 01 016 00...	C016 10H008 002 1	C016 10H008 003 1
		14 + PE	11 x .N 01 015 00... 4 x .N 01 025 00...	C016 10H014 002 1	C016 10H014 003 1
		17 + PE	.N 01 015 00...	C016 10H017 002 1	C016 10H017 003 1
Male cable connector, style K with clamping ring, without contacts ¹⁾		8 + PE	.N 01 016 00...	C016 10K008 002 1	C016 10K008 003 1
		14 + PE	11 x .N 01 015 00... 4 x .N 01 025 00...	C016 10K014 002 1	C016 10K014 003 1
		17 + PE	.N 01 015 00...	C016 10K017 002 1	C016 10K017 003 1

¹⁾ Please order crimp contacts separately, see page 30/31.

²⁾ Part No system for crimp contacts, see page 32.

³⁾ Cable outlet in mm, see page 32.

C 16-3

Shell size 1
Female receptacles



G

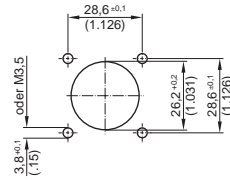

Panel cutout



N

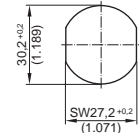

Panel cutout

Identification	Drawing	No. of cont.	Contacts ²⁾	Part No.
Female receptacle, without contacts ¹⁾		8 + PE	.N 02 016 00...	C016 10G008 000 1
		14 + PE	11 x .N 02 015 00... 4 x .N 02 025 00...	C016 10G014 000 1
		17 + PE	.N 02 015 00...	C016 10G017 000 1
Female receptacle, style N, without contacts ¹⁾		8 + PE	.N 02 016 00...	C016 10N008 006 1
		14 + PE	11 x .N 02 015 00... 4 x .N 02 025 00...	C016 10N014 006 1
		17 + PE	.N 02 015 00...	C016 10N017 006 1

C 16-3

Shell size 1
Female cable connectors



E



D



F

Identification	Drawing	No. of cont.	Contacts ²⁾	Part No. Cable outlet ³⁾	
				PG 11	PG 13,5
Female cable connector, long, style E with internal strain relief, without contacts ¹⁾		8 + PE	.N 02 016 00...	C016 10E008 002 1	C016 10E008 003 1
		14 + PE	11 x .N 02 015 00... 4 x .N 02 025 00...	C016 10E014 002 1	C016 10E014 003 1
		17 + PE	.N 02 015 00...	C016 10E017 002 1	C016 10E017 003 1
Female cable connector, short, style D with clamping ring, without contacts ¹⁾		8 + PE	.N 02 016 00...	C016 10D008 002 1	C016 10D008 003 1
		14 + PE	11 x .N 02 015 00... 4 x .N 02 025 00...	C016 10D014 002 1	C016 10D014 003 1
		17 + PE	.N 02 015 00...	C016 10D017 002 1	C016 10D017 003 1
Female cable connector, style F with clamping ring, without contacts ¹⁾		8 + PE	.N 02 016 00...	C016 10F008 002 1	C016 10F008 003 1
		14 + PE	11 x .N 02 015 00... 4 x .N 02 025 00...	C016 10F014 002 1	C016 10F014 003 1
		17 + PE	.N 02 015 0005	C016 10F017 002 1	C016 10F017 003 1

¹⁾ Please order crimp contacts separately, see page 30/31.

²⁾ Part No system for crimp contacts, see page 32.

³⁾ Cable outlet in mm, see page 32.

C 16-3

Shell size 1
Male receptacles



C

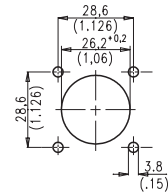

Panel cutout

Identification	Drawing	No. of cont.	Contacts ²⁾	Part No.
Male receptacle, style C, without contacts ¹⁾		8 + PE	.N 01 016 00...	C016 10C008 000 1
		14 + PE	11 x .N 01 015 00... 4 x .N 01 025 00...	C016 10C014 000 1
		17 + PE	.N 01 015 00...	C016 10C017 000 1

C 16-3

Shell size 1
Accessories



Identification	Drawing	Part No.	
		for male cable connector	for male receptacle
Protective cap for male cable connector and male receptacle.		C016 00U000 000 1	C016 00U000 020 1
Protective cap for female cable connector and female receptacle.		C016 00V000 000 1	C016 00V000 020 1
Disassembly tool for pin-and socket inserts		FH 0000-016	

¹⁾ Please order crimp contacts separately, see page 30/31.

²⁾ Part No system for crimp contacts, see page 32.

C 16-3

Shell size 2
Male cable connectors



I

H

K

Description	Drawing	No. of cont.	Contacts ²⁾	Part No. Cable outlet ³⁾		
				PG 13,5	PG 16	PG 21
Male cable connector, long, style I with internal strain relief, 5 + PE screw termination, 12 + PE-, 14 + PE and 19 + PE-version without contacts ¹⁾		5 + PE	–	C016 20I005 103 2	C016 20I005 104 2	C016 20I005 105 2
		12 + PE	9 x .N 01 016 00... 4 x .N 01 025 00...	C016 10I012 003 2	C016 10I012 004 2	C016 10I012 005 2
		14 + PE	4 x .N 01 015 00... 11 x .N 01 016 00...	C016 10I014 003 2	C016 10I014 004 2	C016 10I014 005 2
		19 + PE	.N 01 015 000...	C016 10I019 003 2	C016 10I019 004 2	C016 10I019 005 2
Male cable connector, short, style H with clamping ring, 5 + PE screw termination, 12 + PE-, 14 + PE and 19 + PE-version without contacts ¹⁾		5 + PE	–	C016 20H005 103 2	C016 20H005 104 2	–
		12 + PE	9 x .N 01 016 00... 4 x .N 01 025 00...	C016 10H012 003 2	C016 10H012 004 2	–
		14 + PE	4 x .N 01 015 00... 11 x .N 01 016 00...	C016 10H014 003 2	C016 10H014 004 2	C016 10H014 005 2
		19 + PE	.N 01 015 00...	C016 10H019 003 2	C016 10H019 004 2	–
Male cable connector, short, style K with clamping ring, 5 + PE screw termination, 12 + PE-, 14 + PE and 19 + PE-version without contacts ¹⁾		5 + PE	–	–	C016 20K005 104 2	–
		12 + PE	9 x .N 01 016 00... 4 x .N 01 025 00...	–	C016 10K012 004 2	–
		14 + PE	4 x .N 01 015 00... 11 x .N 01 016 00...	–	C016 10K014 004 2	–
		19 + PE	.N 01 015 00...	–	C016 10K019 004 2	–

C 16-3

Shell size 2
Female receptacle



G

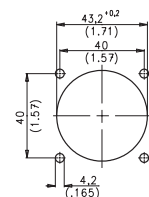

Panel cutout

Identification	Drawing	No. of cont.	Contacts ²⁾	Part No.
Female receptacle, style G, 5 + PE screw termination, 12 + PE-, 14 + PE and 19 + PE-version without contacts ¹⁾		5 + PE	–	C016 20G005 100 2
		12 + PE	9 x .N 02 016 00... 4 x .N 02 025 00...	C016 10G012 000 2
		14 + PE	4 x .N 02 015 00... 11 x .N 02 016 00...	C016 10G014 000 2
		19 + PE	.N 02 015 00...	C016 10G019 000 2

¹⁾ Please order crimp contacts separately, see page 30/31.

²⁾ Part No system for crimp contacts, see page 32.

³⁾ Cable outlet in mm, see page 32.

C 16-3

Shell size 2
Female cable connectors



E

D

F

Description	Drawing	No. of cont.	Contacts ²⁾	Part No. Cable outlet ³⁾		
				PG 13,5	PG 16	PG 21
Female cable connector, long, style E with internal strain relief, 5 + PE screw termination, 12 + PE-, 14 + PE and 19 + PE-version without contacts ¹⁾		5 + PE	-	C016 20E005 103 2	C016 20E005 104 2	C016 20E005 105 2
		12 + PE	9 x .N 02 016 00... 4 x .N 02 025 00...	C016 10E012 003 2	C016 10E012 004 2	C016 10E012 005 2
		14 + PE	4 x .N 02 015 00... 11 x .N 02 016 00...	C016 10E014 003 2	C016 10E014 004 2	C016 10E014 005 2
		19 + PE	.N 02 015 00...	C016 10E019 003 2	C016 10E019 004 2	C016 10E019 005 2
Female cable connector, short, style D with clamping ring, 5 + PE screw termination, 12 + PE-, 14 + PE and 19 + PE-version without contacts ¹⁾		5 + PE	-	C016 20D005 103 2	C016 20D005 104 2	-
		12 + PE	9 x .N 02 016 00... 4 x .N 02 025 00...	C016 10D012 003 2	C016 10D012 004 2	-
		14 + PE	4 x .N 02 015 00... 11 x .N 02 016 00...	C016 10D014 003 2	C016 10D014 004 2	-
		19 + PE	.N 01 015 00...	C016 10D019 003 2	C016 10D019 004 2	-
Female cable connector, style F with clamping ring, 5 + PE screw termination, 12 + PE-, 14 + PE and 19 + PE-version without contacts ¹⁾		5 + PE	-	-	C016 20F005 104 2	-
		12 + PE	9 x .N 02 016 00... 4 x .N 02 025 00...	-	C016 10F012 004 2	-
		14 + PE	4 x .N 02 015 00...	-	C016 10F014 004 2	-
		19 + PE	.N 02 015 00...	-	C016 10F019 004 2	-

C 16-3

Shell size 2
Male receptacle



C

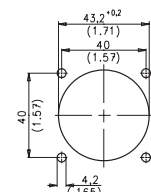

Panel cutout

Description	Drawing	No. of cont.	Contacts ²⁾	Part No.
Male receptacle, style C, 5 + PE screw termination, 12 + PE-, 14 + PE and 19 + PE-version without contacts ¹⁾		5 + PE	-	C016 20C005 100 2
		12 + PE	9 x .N 01 016 00... 4 x .N 01 015 00...	C016 10C012 000 2
		14 + PE	4 x .N 01 015 00... 11 x .N 01 016 00...	C016 10C014 000 2
		19 + PE	.N 01 015 00...	C016 10C019 000 2

¹⁾ Please order crimp contacts separately, see page 30/31.



²⁾ Part No system for crimp contacts, see page 32.

³⁾ Cable outlet in mm, see page 32.

C 16-3

Shell size 2 Accessories

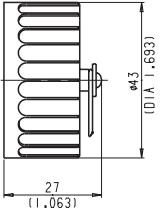
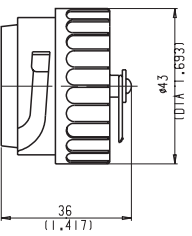

Description	Figure	Part No.	
Protective cap for male cable connector and male receptacle		for male cable connector C016 00U000 010 2	for male receptacle C016 00U000 000 2
Protective cap for female cable connector and female receptacle		for female cable connector C016 00V000 010 2	for female receptacle C016 00V000 000 2
Disassembly tool for pin-and socket inserts		FH 0002-016	

C 16-1 und 16-3

Crimp contacts
Pin

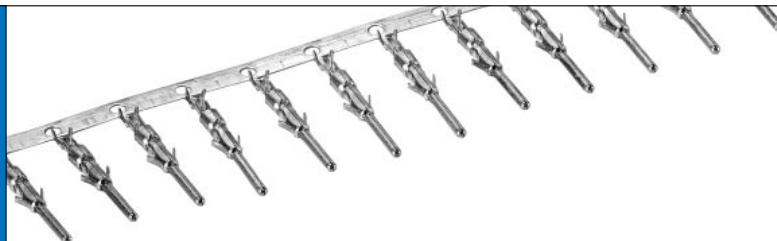

Series	Contact Ø in mm	Insulation Ø in mm	No. of cont.	Shell size	Wire gauge in mm ² AWG	Supplied as	pcs.	Part No. Contact plating			
								silver	gold		
C 16-1	1,6	1,0 - 2,0	6 + PE	-	0,14 - 0,5	single contact	100	VN 01 016 0011 (1)	VN 01 016 0011 (2)		
						contacts on reel	200	ZN 01 016 0011 (1)	ZN 01 016 0011 (2)		
							2000	HN 01 016 0011 (1)	HN 01 016 0011 (2)		
C 16-1	1,6	1,8 - 2,8	6 + PE	-	0,5 - 1,5	single contact	100	VN 01 016 0004 (1)	VN 01 016 0004 (2)		
						contacts on reel	200	ZN 01 016 0004 (1)	ZN 01 016 0004 (2)		
							2000	HN 01 016 0004 (1)	HN 01 016 0004 (2)		
C 16-3	1,5	1,6 - 2,3	14 + PE	1	0,14 - 0,5	single contact	100	VN 01 015 0005 (1)	VN 01 015 0005 (2)		
			17 + PE	1		contacts on reel	200	ZN 01 015 0005 (1)	ZN 01 015 0005 (2)		
			14 + PE	2			2000	HN 01 015 0005 (1)	HN 01 015 0005 (2)		
			19 + PE	2							
C 16-3	1,5	1,8 - 2,0	14 + PE	1	0,5 - 1,0	single contact	100	VN 01 015 0039 (1)	VN 01 015 0039 (2)		
			17 + PE	1		contacts on reel	200	ZN 01 015 0039 (1)	ZN 01 015 0039 (2)		
			14 + PE	2			2000	HN 01 015 0039 (1)	HN 01 015 0039 (2)		
			19 + PE	2							
C 16-3	1,6	1,0 - 2,0	8 + PE	1	0,14 - 0,5	single contact	100	VN 01 016 0003 (1)	VN 01 016 0003 (2)		
			12 + PE	2		contacts on reel	200	ZN 01 016 0003 (1)	ZN 01 016 0003 (2)		
			14 + PE	2			2000	HN 01 016 0003 (1)	HN 01 016 0003 (2)		
C 16-3	1,6	1,8 - 2,8	8 + PE	1	0,5 - 1,5	single contact	100	VN 01 016 0002 (1)	VN 01 016 0002 (2)		
			12 + PE	2		contacts on reel	200	ZN 01 016 0002 (1)	ZN 01 016 0002 (2)		
			14 + PE	2			2000	HN 01 016 0002 (1)	HN 01 016 0002 (2)		
C 16-3	1,6	2,5 - 3,5	8 + PE	1	1,5 - 2,5	single contact	100	VN 01 016 0005 (1)	VN 01 016 0005 (2)		
			12 + PE	2		contacts on reel	200	ZN 01 016 0005 (1)	ZN 01 016 0005 (2)		
			14 + PE	2			2000	HN 01 016 0005 (1)	HN 01 016 0005 (2)		
C 16-3	2,5	1,8 - 2,8	14 + PE	1	0,5 - 1,5	single contact	100	VN 01 025 0001 (101)	VN 01 025 0001 (102)		
			12 + PE	2		20 - 16	contacts on reel	200	ZN 01 025 0001 (1)	ZN 01 025 0001 (2)	
							2000	HN 01 025 0001 (1)	HN 01 025 0001 (2)		
	2,5 - 3,5	14 + PE	1	1,5 - 2,5	single contact	100	VN 01 025 0010 (101)	VN 01 025 0010 (102)			
					12 + PE	2	16 - 14	contacts on reel	200	ZN 01 025 0010 (1)	ZN 01 025 0010 (2)
								2000	HN 01 025 0010 (1)	HN 01 025 0010 (2)	

C 16-1 und 16-3

Crimp contacts
Socket

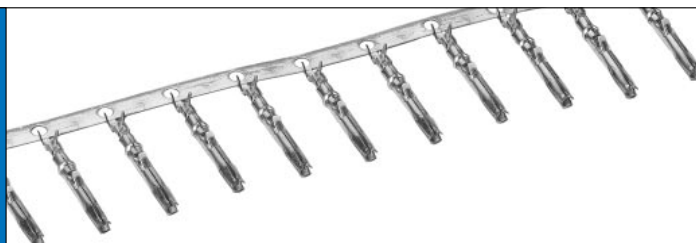

Series	Contact Ø in mm	Insulation Ø in mm	No. of cont.	Shell size	Wire gauge in mm ² AWG	Supplied as	pcs.	Part No. Contact plating	
								silver	gold
C 16-3	1,5	1,0 - 2,0	14 + PE	1	0,14 - 0,5	single contact	100	VN 02 015 0005 (1)	VN 02 015 0005 (2)
			17 + PE	1	26 - 20	contacts on reel	200	ZN 02 015 0005 (1)	ZN 02 015 0005 (2)
			14 + PE	2			2000	HN 02 015 0005 (1)	HN 02 015 0005 (2)
			19 + PE	2					
C 16-3	1,5	1,6 - 2,3	14 + PE	1	0,5 - 1,0	single contact	100	VN 02 015 0039 (1)	VN 02 015 0039 (2)
			17 + PE	1	20 - 18	contacts on reel	200	ZN 02 015 0039 (1)	ZN 02 015 0039 (2)
			14 + PE	2			2000	HN 02 015 0039 (1)	HN 02 015 0039 (2)
			19 + PE	2					
C 16-1 C 16-3	1,6	1,0 - 2,0	6 + PE	–	0,14 - 0,5	single contact	100	VN 02 016 0003 (1)	VN 02 016 0003 (2)
			8 + PE	1	26 - 20	contacts on reel	200	ZN 02 016 0003 (1)	ZN 02 016 0003 (2)
			12 + PE	2			2000	HN 02 016 0003 (1)	HN 02 016 0003 (2)
			14 + PE	2					
			19 + PE	2					
C 16-1 C 16-3	1,6	1,8 - 2,8	6 + PE	–	0,5 - 1,5	single contact	100	VN 02 016 0002 (1)	VN 02 016 0002 (2)
			8 + PE	1	20 - 16	contacts on reel	200	ZN 02 016 0002 (1)	ZN 02 016 0002 (2)
			12 + PE	2			2000	HN 02 016 0002 (1)	HN 02 016 0002 (2)
			14 + PE	2					
C 16-1 C 16-3	1,6	2,5 - 3,5	6 + PE	–	1,5 - 2,5	single contact	100	VN 02 016 0005 (1)	VN 02 016 0005 (2)
			8 + PE	1	16 - 14	contacts on reel	200	ZN 02 016 0005 (1)	ZN 02 016 0005 (2)
			12 + PE	2			2000	HN 02 016 0005 (1)	HN 02 016 0005 (2)
			14 + PE	2					
C 16-3	2,5	1,8 - 2,8	14 + PE	1	0,5 - 1,5	single contact	100	VN 02 025 0001 (101)	VN 02 025 0001 (102)
			12 + PE	2	20 - 16	contacts on reel	200	ZN 02 025 0001 (1)	ZN 02 025 0001 (2)
			14 + PE	2			2000	HN 02 025 0001 (1)	HN 02 025 0001 (2)
C 16-3	2,5	2,5 - 3,5	14 + PE	1	1,5 - 2,5	single contact	100	VN 02 025 0010 (101)	VN 02 025 0010 (102)
			12 + PE	2	16 - 14	contacts on reel	200	ZN 02 025 0010 (1)	ZN 02 025 0010 (2)
			14 + PE	2			2000	HN 02 025 0010 (1)	HN 02 025 0010 (2)

Part No. system for crimp contacts

VN **01** **016** **0001** **(1)**
 1) 2) 3) 4) 5)

- 1) supplied as:
- VN = single contact 100 pcs.
 - ZN = contacts on reel 100, 200 or 400 contacts
 - HN = Contacts on reel with 2000 contacts for Acrimat FD (contact feeding right hand side)
 - TN = Contacts on reel with 2000 contacts for Acrimat II + III (contact feeding left hand side)
- 2) Type of contact:
- 01 = male contact
 - 02 = female contacts
- 3) Contact pin dia.: e. g. 016 $\hat{=}$ 1,6 mm
- 4) Index of version (wire gauge)
- 5) Plating:
- (1) = silver plated
 - (2) = gold plated
 - (4) = gold plated for high performance

Cable outlet in mm

Gland bushing without clamping ring		Gland bushing with clamping ring	
PG	cable dia. in mm / inches	PG	cable dia. in mm / inches
9	8 - 10 / 0.315 - 0.394	9	6 - 8 / 0.236 - 0.315
11	10 - 12 / 0.394 - 0.472	11	8 - 10 / 0.315 - 0.394
13,5	12 - 14 / 0.472 - 0.551	13,5	10 - 12 / 0.394 - 0.472
16	14 - 16 / 0.551 - 0.629	16	12 - 14 / 0.472 - 0.551
21	19 - 21 / 0.748 - 0.826	21	14 - 18 / 0.551 - 0.709

Summary of Part No.

Part No.	Page	Part No.	Page	Part No.	Page	Part No.	Page
C016 00U000 000 1	26	C016 10E014 003 2	28	C016 10H019 003 2	27	C016 20E005 103 2	28
C016 00U000 000 2	29	C016 10E014 004 2	28	C016 10H019 004 2	27	C016 20E005 104 2	28
C016 00U000 010 2	29	C016 10E014 005 2	28	C016 10H17 003 1	24	C016 20E005 105 2	28
C016 00U000 020 1	26	C016 10E017 002 1	25	C016 10I008 002 1	24	C016 20F005 104 2	28
C016 00V000 000 1	26	C016 10E017 003 1	25	C016 10I008 003 1	24	C016 20G005 100 2	27
C016 00V000 000 2	29	C016 10E019 003 2	28	C016 10I012 003 2	27	C016 20H005 103 2	27
C016 00V000 010 2	29	C016 10E019 004 2	28	C016 10I012 004 2	27	C016 20H005 104 2	27
C016 00V000 020 1	26	C016 10E019 005 2	28	C016 10I012 005 2	27	C016 20I005 103 2	27
C016 10C008 000 1	26	C016 10F008 002 1	25	C016 10I014 002 1	24	C016 20I005 104 2	27
C016 10C012 000 2	28	C016 10F008 003 1	25	C016 10I014 003 1	24	C016 20I005 105 2	27
C016 10C014 000 1	26	C016 10F012 004 2	28	C016 10I014 003 2	27	C016 20K005 104 2	27
C016 10C014 000 2	28	C016 10F014 002 1	25	C016 10I014 004 2	27	FH 0000-016	26
C016 10C017 000 1	26	C016 10F014 003 1	25	C016 10I014 005 2	27	FH 0002-016	29
C016 10C019 000 2	28	C016 10F014 004 2	28	C016 10I017 002 1	24	HN 01 015 0005 (1)	30
C016 10D008 002 1	25	C016 10F017 002 1	25	C016 10I017 003 1	24	HN 01 015 0005 (2)	30
C016 10D008 003 1	25	C016 10F017 003 1	25	C016 10I019 003 2	27	HN 01 015 0039 (1)	30
C016 10D012 003 2	28	C016 10F019 004 2	28	C016 10I019 004 2	27	HN 01 015 0039 (2)	30
C016 10D012 004 2	28	C016 10G008 000 1	25	C016 10I019 005 2	27	HN 01 016 0002 (1)	30
C016 10D014 002 1	25	C016 10G012 000 2	27	C016 10K008 002 1	24	HN 01 016 0002 (2)	30
C016 10D014 003 1	25	C016 10G014 000 1	25	C016 10K008 003 1	24	HN 01 016 0003 (1)	30
C016 10D014 003 2	28	C016 10G014 000 2	27	C016 10K012 004 2	27	HN 01 016 0003 (2)	30
C016 10D014 004 2	28	C016 10G017 000 1	25	C016 10K014 002 1	24	HN 01 016 0004 (1)	30
C016 10D017 002 1	25	C016 10G019 000 2	27	C016 10K014 003 1	24	HN 01 016 0004 (2)	30
C016 10D017 003 1	25	C016 10H008 002 1	24	C016 10K014 004 2	27	HN 01 016 0005 (1)	30
C016 10D019 003 2	28	C016 10H008 003 1	24	C016 10K017 002 1	24	HN 01 016 0005 (2)	30
C016 10D019 004 2	28	C016 10H012 003 2	27	C016 10K017 003 1	24	HN 01 016 0011 (1)	30
C016 10E008 002 1	25	C016 10H012 004 2	27	C016 10K019 004 2	27	HN 01 016 0011 (2)	30
C016 10E008 003 1	25	C016 10H014 002 1	24	C016 10N008 006 1	25	HN 01 025 0001 (1)	30
C016 10E012 003 2	28	C016 10H014 003 1	24	C016 10N014 006 1	25	HN 01 025 0001 (2)	30
C016 10E012 004 2	28	C016 10H014 003 2	27	C016 10N017 006 1	25	HN 01 025 0010 (1)	30
C016 10E012 005 2	28	C016 10H014 004 2	27	C016 20C005 100 2	28	HN 01 025 0010 (2)	30
C016 10E014 002 1	25	C016 10H014 005 2	27	C016 20D005 103 2	28	HN 02 015 0005 (1)	31
C016 10E014 003 1	25	C016 10H017 002 1	24	C016 20D005 104 2	28	HN 02 015 0005 (2)	31

Summary of Part No.

Part No.	Page	Part No.	Page	Part No.	Page	Part No.	Page
HN 02 015 0039 (1)	31	T 3105 091	12	T 6483 000	14	VN 02 025 0010 (102)	31
HN 02 015 0039 (2)	31	T 3105 100	12	T 6483 001	14	ZN 01 015 0005 (1)	30
HN 02 016 0002 (1)	31	T 3105 101	12	VN 01 015 0005 (1)	30	ZN 01 015 0005 (2)	30
HN 02 016 0002 (2)	31	T 3105 200	12	VN 01 015 0005 (2)	30	ZN 01 015 0039 (1)	30
HN 02 016 0003 (1)	31	T 3105 501	12	VN 01 015 0039 (1)	30	ZN 01 015 0039 (2)	30
HN 02 016 0003 (2)	31	T 3105 581	12	VN 01 015 0039 (2)	30	ZN 01 016 0002 (1)	30
HN 02 016 0005 (1)	31	T 3105 591	12	VN 01 016 0002 (1)	30	ZN 01 016 0002 (2)	30
HN 02 016 0005 (2)	31	T 3105 601	12	VN 01 016 0002 (2)	30	ZN 01 016 0003 (1)	30
HN 02 025 0001 (1)	31	T 3105 701	12	VN 01 016 0003 (1)	30	ZN 01 016 0003 (2)	30
HN 02 025 0001 (2)	31	T 3106 000	13	VN 01 016 0003 (2)	30	ZN 01 016 0004 (1)	30
HN 02 025 0010 (1)	31	T 3106 010	13	VN 01 016 0004 (1)	30	ZN 01 016 0004 (2)	30
HN 02 025 0010 (2)	31	T 3106 500	13	VN 01 016 0004 (2)	30	ZN 01 016 0005 (1)	30
N 16 110 2000 X	14	T 3107 000	11	VN 01 016 0005 (1)	30	ZN 01 016 0005 (2)	30
T 3102 003 7 X	14	T 3107 500	11	VN 01 016 0005 (2)	30	ZN 01 016 0011 (1)	30
T 3102 004 7 X	14	T 3108 000	10	VN 01 016 0011 (1)	30	ZN 01 016 0011 (2)	30
T 3102 005 7 X	14	T 3108 001	10	VN 01 016 0011 (2)	30	ZN 01 025 0001 (1)	30
T 3102 014 7 X	14	T 3108 081	10	VN 01 025 0001 (101)	30	ZN 01 025 0001 (2)	30
T 3102 015 7 X	14	T 3108 091	10	VN 01 025 0001 (102)	30	ZN 01 025 0010 (1)	30
T 3104 000	10	T 3108 100	10	VN 01 025 0010 (101)	30	ZN 01 025 0010 (2)	30
T 3104 001	10	T 3108 101	10	VN 01 025 0010 (102)	30	ZN 02 015 0005 (1)	31
T 3104 081	10	T 3108 200	10	VN 02 015 0005 (1)	31	ZN 02 015 0005 (2)	31
T 3104 091	10	T 3109 000	12	VN 02 015 0005 (2)	31	ZN 02 015 0039 (1)	31
T 3104 100	10	T 3109 001	12	VN 02 015 0039 (1)	31	ZN 02 015 0039 (2)	31
T 3104 101	10	T 3109 081	12	VN 02 015 0039 (2)	31	ZN 02 016 0002 (1)	31
T 3104 200	10	T 3109 091	12	VN 02 016 0002 (1)	31	ZN 02 016 0002 (2)	31
T 3104 501	10	T 3109 100	12	VN 02 016 0002 (2)	31	ZN 02 016 0003 (1)	31
T 3104 581	10	T 3109 101	12	VN 02 016 0003 (1)	31	ZN 02 016 0003 (2)	31
T 3104 591	10	T 3109 200	12	VN 02 016 0003 (2)	31	ZN 02 016 0005 (1)	31
T 3104 601	10	T 3110 000	13	VN 02 016 0005 (1)	31	ZN 02 016 0005 (2)	31
T 3104 701	10	T 3110 010	13	VN 02 016 0005 (2)	31	ZN 02 025 0001 (1)	31
T 3105 000	12	T 3111 000	11	VN 02 025 0001 (101)	31	ZN 02 025 0001 (2)	31
T 3105 001	12	T 6482 000	14	VN 02 025 0001 (102)	31	ZN 02 025 0010 (1)	31
T 3105 081	12	T 6482 001	14	VN 02 025 0010 (101)	31	ZN 02 025 0010 (2)	31

X-ON Electronics

Authorized Distributor

Click to view similar products for [Standard Circular Connector](#) category:

[15021SP](#) [HEN1M305XLNP](#) [MP4102150P](#) [MP410154P](#) [MP410125PC](#)

[AUXBMW05IPOD](#) [AUXBMW04RCA](#) [RD10A2451P6CS0511](#) [HEX40LKC9009A11](#)

[HEX40AC9013A3C](#)