



WS2811

Signal line 256 Gray level 3 channel Constant current LED driver IC

Feature

- Output port compression 12V.
- Built-in voltage-regulator tube, only a resistance needed to add to IC VDD feet when under 24V power supply.
- 256 Gray-scale adjustable and scan frequency is more than **2KHz**.
- Built in signal reshaping circuit, to ensure waveform distortion do not accumulate after wave reshaping to the next driver
- Built-in electrify reset circuit and power-down reset circuit.
- Cascading port transmission signal by single line.
- Any two point the distance less than 5 Meters transmission signal without any increase circuit.
- When the refresh rate is 30fps, the cascade number is at least 1024 pixels.
- Send data at speed of 800Kbps.

Applications

- LED decorative lighting.
- Indoor/outdoor LED video or irregular screen.

General description

The WS2811 is 3 output channels special for LED driver circuit. Its internal includes intelligent digital port data latch and signal reshaping amplification drive circuit. Also include a precision internal oscillator and a 12V voltage programmable constant current output drive. In the purpose of reduce power supply ripple, the 3 output channels designed to delay turn-on function.

IC use single NZR communication mode. After the chip power-on reset, the DIN port receive data from controller, the first IC collect initial 24bit data then sent to the internal data latch, the other data which reshaping by the internal signal reshaping amplification circuit sent to the next cascade IC through the DO port. After transmission for each chip, the signal to reduce 24bit. IC adopt auto reshaping transmit technology, making the chip cascade number is not limited the signal transmission, only depend on the speed of signal transmission.

The data latch of IC depend on the received 24bit data produce different duty ratio signal at OTR, OUTG, OUTB port. All chip synchronous send the received data to each segment when the DIN port input a reset signal. It will receive new data again After the reset signal finished. Before a new reset signal received, the control signal of OTR ,OUTG, OUTB port unchanged. IC sent PWM data that received justly to OTR, OUTG, OUTB port, after receive a low voltage reset signal the time retain over **280μs**.

We offer TWO package SOP8 and MSOP8.

PIN configuration

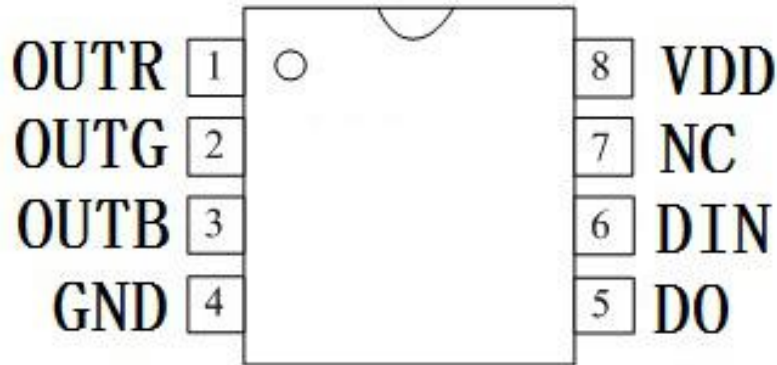

PIN function

| NO. | Symbol | PIN | Function description |
|-----|--------|-------------------|-----------------------------|
| 1 | OUTR | LED Driver Output | Output of RED PWM control |
| 2 | OUTG | LED Driver Output | Output of GREEN PWM control |
| 3 | OUTB | LED Driver Output | Output of BLUE PWM control |
| 4 | GND | Ground | Data & Power Grounding |
| 5 | DO | DO | Data Output |
| 6 | DIN | Data Input | Control data input |
| 7 | NC | NC | NC |
| 8 | VDD | Power Voltage | IC power supply |

Absolute Maximum Ratings (T_A=25°C, V_{SS}=0V, unless otherwise noted.)

| Parameter | Symbol | Ratings | Unit |
|---|------------------|-----------------|------|
| Power Supply Voltage | V _{DD} | +3.5~+5.3 | V |
| Logical Input Voltage | V _I | VDD-0.5~VDD+0.5 | V |
| Operation Temperature | T _{opt} | -25~+85 | °C |
| Storage Temperature Range | T _{stg} | -40~105 | °C |
| R/G/B Channel Output Port Withstand Voltage | V _{out} | 12 | V |

Note: If the voltage on the pins exceeds the maximum ratings may cause permanent damage to the device.



Electrical Characteristics ($T_A=-20\sim+70^{\circ}\text{C}$, $V_{DD}=4.5\sim 5.5\text{V}$, $V_{SS}=0\text{V}$, unless otherwise specified)

| Parameter | Symbol | Conditions | Min | Tpy | Max | Unit |
|----------------------------|------------|-------------------------------|-------------|------|--------------|---------------|
| Low voltage output current | I_{OL} | ROUT | 15.5 | 16.5 | 17.5 | mA |
| | I_{dout} | $V_o=0.4\text{V}$, D_{OUT} | 10 | — | — | mA |
| Input current | I_I | $V_I=V_{DD}/V_{SS}$ | — | — | ± 1 | μA |
| Input voltage level | V_{IH} | D_{IN} , SET | $0.7V_{DD}$ | — | — | V |
| | V_{IL} | D_{IN} , SET | — | — | $0.3 V_{DD}$ | V |
| Hysteresis voltage | V_H | D_{IN} , SET | — | 0.35 | — | V |

Switching characteristics ($T_A=-20\sim+70^{\circ}\text{C}$, $V_{DD}=4.5\sim 5.5\text{V}$, $V_{SS}=0\text{V}$, unless otherwise specified)

| Parameter | Symbol | Condition | Min | Tpy | Max | Unit |
|-------------------------|-----------|--|-----|-----|-----|---------------|
| Oscillation frequency | F_{osc} | — | — | 800 | — | KHz |
| Transmission delay time | T_{PLZ} | $CL=15\text{pF}$, $D_{IN}\rightarrow D_{OUT}$, $RL=10\text{K}\Omega$ | — | — | 300 | ns |
| Fall time | T_{THZ} | $CL=300\text{pF}$, $OUTR/OUTG/OUTB$ | — | — | 120 | μs |
| Data transmission rate | F_{MAX} | Duty ratio 50% | 400 | — | — | Kbps |
| Input capacity | C_I | — | — | — | 15 | pF |

Data Transfer Time

| | | |
|-----|------------------------------|-------------------------|
| T0H | 0 code, high voltage time | 220ns~380ns |
| T1H | 1 code, high voltage time | 580ns~1.6 μs |
| T0L | 0 code, low voltage time | 580ns~1.6 μs |
| T1L | 1 code, low voltage time | 220ns~420ns |
| RES | Frame unit, low voltage time | >280 μs |

Sequence Chart

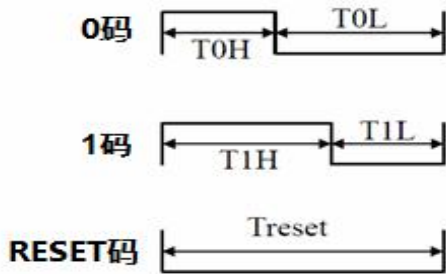

Cascade Method

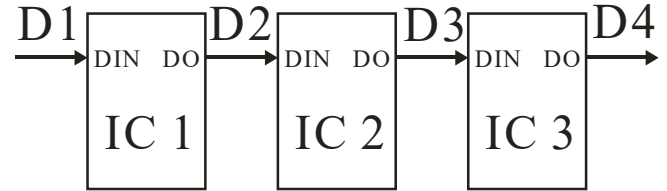

Data Transmission Method

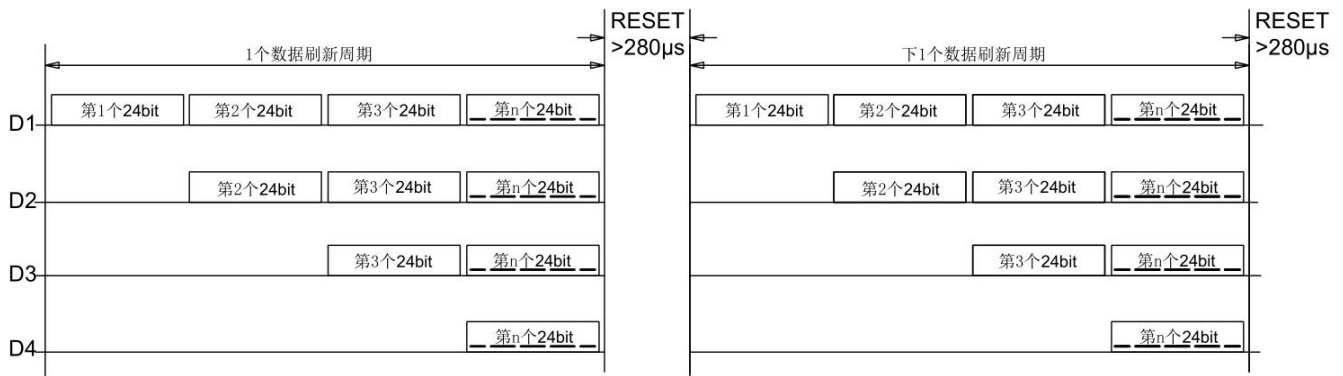

Note: The data of D1 is send by MCU, and D2, D3, D4 through IC internal reshaping amplification to transmit.

Composition of 24bit Data

| | | | | | | | | | | | | | | | | | | | | | | | |
|----|----|----|----|----|----|----|----|----|----|----|----|----|----|----|----|----|----|----|----|----|----|----|----|
| R7 | R6 | R5 | R4 | R3 | R2 | R1 | R0 | G7 | G6 | G5 | G4 | G3 | G2 | G1 | G0 | B7 | B6 | B5 | B4 | B3 | B2 | B1 | B0 |
|----|----|----|----|----|----|----|----|----|----|----|----|----|----|----|----|----|----|----|----|----|----|----|----|

Note: Data transmit in order of GRB, high bit data at first.

Typical Application Circuit

1. Supply voltage=5V, 1 LED for each channel and Constant Current driving of 16.5mA

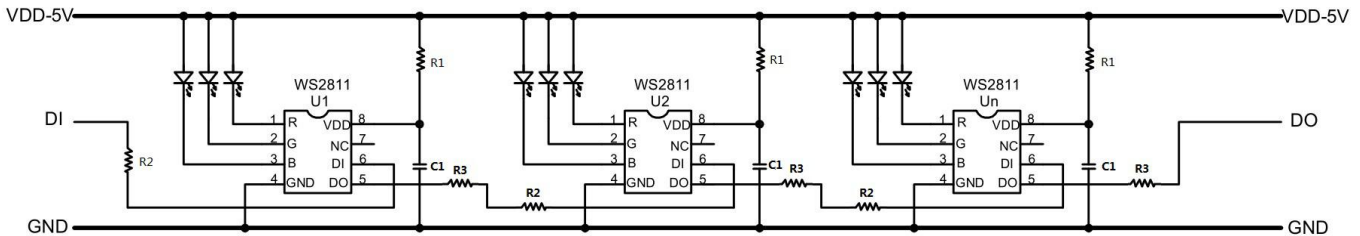

Fig 1

This driving mode use constant current output, the advantage of is the LED can retain luminance and color temperature when the power supply lessen. We require, in order to prevent power spikes phenomenon and power reverse polarity, series with a resistor less than 100ohm connected with the power supply pin(VDD). The capacitance 104 as bypass capacitor. To prevent the reflection and hot-swap protection, we suggest to connect a 33ohm resistor at the data input or output port for impedance.

2. Supply voltage=12V, 3 LED for each channel and Constant Current driving of 16.5mA

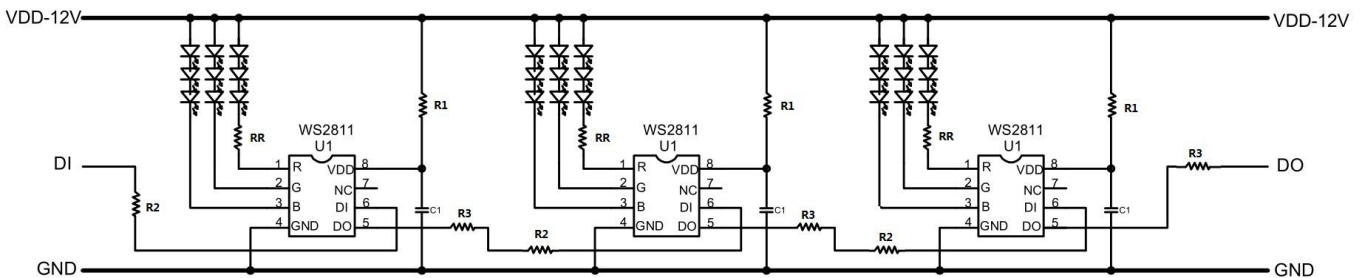

Fig 2

The same as the front mode, it is also use constant current output. In this circuit, R1 is used as the IC internal LDO divider resistance and the value is 2.7K. The capacitance 104 as bypass capacitor. To prevent the reflection and hot-swap protection, we suggest to connect a 33ohm resistor at the data input or output port for impedance. At the OUTR port we should add a divider resistance RR. The value of RR can be derived by the following equation:

$$RR = \frac{12 - 3V_{LEDR}}{16.5} \text{ K}\Omega$$

V_{LEDR} is the red LED forward conduction voltage drop.



Worldsemi

WS2811

Signal line 256 Gray level 3 channel
Constant current LED driver IC

● SOP8 Package

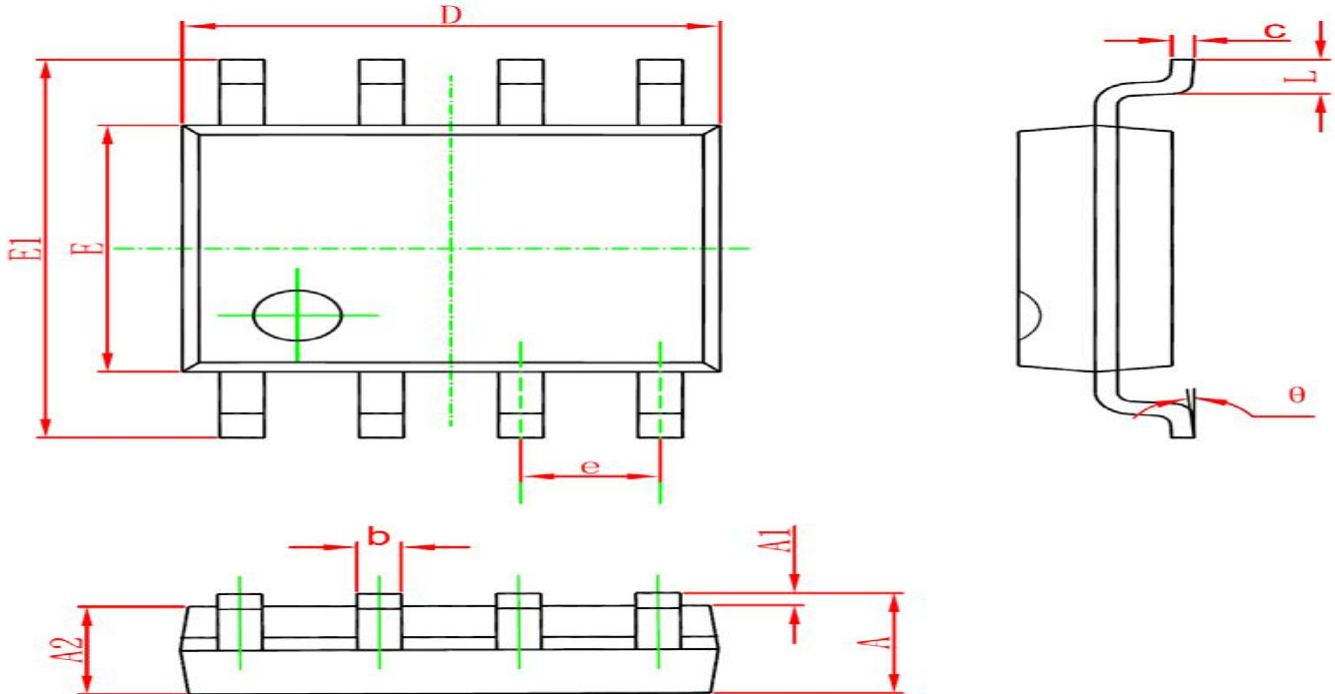

| Symbol | Dimensions In Millimeters | | Dimensions In Inches | |
|--------|---------------------------|-------|----------------------|-------|
| | Min | Max | Min | Max |
| A | 1.350 | 1.750 | 0.053 | 0.069 |
| A1 | 0.100 | 0.250 | 0.004 | 0.010 |
| A2 | 1.350 | 1.550 | 0.053 | 0.061 |
| b | 0.330 | 0.510 | 0.013 | 0.020 |
| c | 0.170 | 0.250 | 0.006 | 0.010 |
| D | 4.700 | 5.100 | 0.185 | 0.200 |
| E | 3.800 | 4.000 | 0.150 | 0.157 |
| E1 | 5.800 | 6.200 | 0.228 | 0.244 |
| e | 1.270 | | 0.050 | |
| L | 0.400 | 1.270 | 0.016 | 0.050 |
| theta | 0° | 8° | 0° | 8° |



Worldsemi

WS2811

Signal line 256 Gray level 3 channel
Constant current LED driver IC

- MSOP8 Package

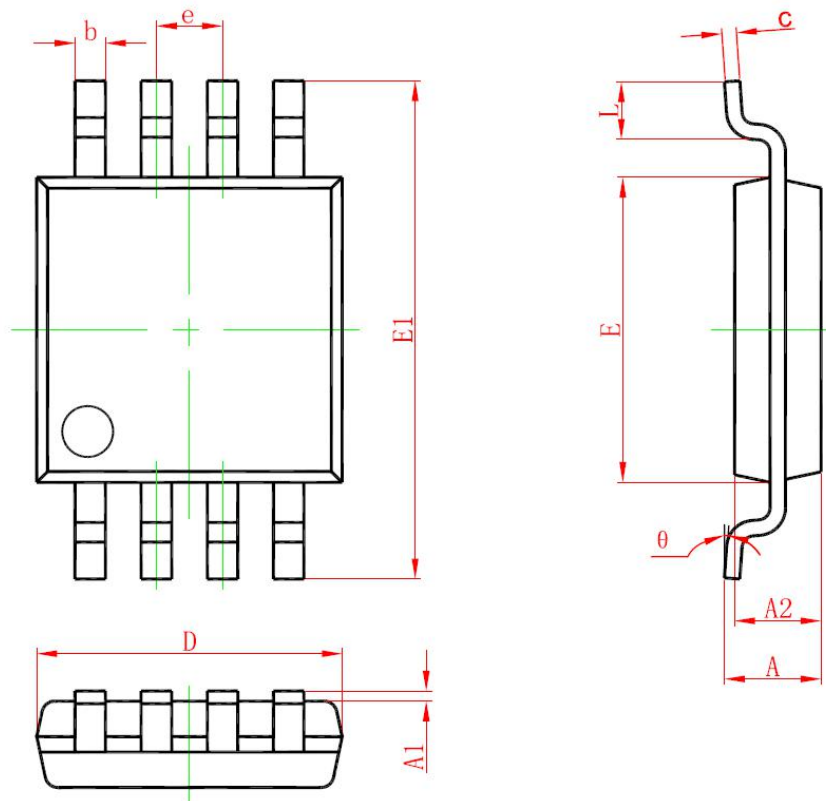

| Symbol | Dimensions In Millimeters | | Dimensions In Inches | |
|----------|---------------------------|-------|----------------------|-------|
| | Min | Max | Min | Max |
| A | 0.820 | 1.100 | 0.032 | 0.043 |
| A1 | 0.020 | 0.150 | 0.001 | 0.006 |
| A2 | 0.750 | 0.950 | 0.030 | 0.037 |
| b | 0.250 | 0.380 | 0.010 | 0.015 |
| c | 0.090 | 0.230 | 0.004 | 0.009 |
| D | 2.900 | 3.100 | 0.114 | 0.122 |
| e | 0.650(BSC) | | 0.026(BSC) | |
| E | 2.900 | 3.100 | 0.114 | 0.122 |
| E1 | 4.750 | 5.050 | 0.187 | 0.199 |
| L | 0.400 | 0.800 | 0.016 | 0.031 |
| θ | 0° | 6° | 0° | 6° |



WS2811

Signal line 256 Gray level 3 channel Constant current LED driver IC

Modify Records

| Version № | Status Bar | Modify Content Summary | Date | Reviser | Approved |
|-----------|------------|--------------------------|----------|-------------|-------------|
| V1.0 | N | New | 20170523 | Shen JinGuo | Yin HuaPing |
| V1.1 | M | Absolute Maximum Ratings | 20171009 | Shen JinGuo | Yin HuaPing |
| | | | | | |
| | | | | | |
| | | | | | |
| | | | | | |

Remarks: Initial version: V1.0; Version number plus "0.1" after each revision;

Status bar: N--New, A--Add, M--Modify, D--Delete.

X-ON Electronics

Largest Supplier of Electrical and Electronic Components

Click to view similar products for [LED Lighting Bars and Strips category](#):

Click to view products by [Worldsemi manufacturer](#):

Other Similar products are found below :

[ZLF0310W62524](#) [LF1D-F2F-2W-300](#) [HH-SWW320F210W24-COB IP65](#) [HH-SNW320F210W12-COB IP65](#) [HH-SNW320F010W12-COB IP20](#) [HH-SNW320F210W24-COB IP65](#) [HH-SNW320F010W24-COB IP20](#) [HH-SNW528F210W12-COB IP65](#) [HH-SNW528F010W12-COB IP20](#) [HH-SNW528F010W24-COB IP20](#) [HH-SCW320F210W12-COB IP65](#) [HH-SCW320F010W12-COB IP20](#) [HH-SCW528F210W12-COB IP65](#) [HH-SCW528F010W12-COB IP20](#) [HH-SR528F010W12-COB IP20](#) [HH-SR528F010W24-COB IP20](#) [LF2D-EN2F-2W-A](#) [PUUA-100LLL-NK2P](#) [HC-F12V-3535 PCBA](#) [HC-F12V-WS2811-3535](#) [HC-F24V-6L-36LED-W-WS2821/IP20](#) [HC-F5V-144L-144LED-B-WS2813 IP20](#) [HC-F5V-144L-144LED-B-WS2813 IP65](#) [HC-F5V-144L-144LED-W/IP65](#) [HC-F5V-144L-144LED-W-WS2813 IP20](#) [HC-F5V-30L-30LED-B-WS2813 IP20](#) [HC-F5V-60L-60LED-B-WS2813 IP20](#) [HC-F5V-60L-60LED-W-WS2813 IP65](#) [HC-T12V-10L-30LED-W/IP20](#) [HC-T12V-16L-48LED-W/IP20](#) [HC-T12V-16L-48LED-W/IP65](#) [HC-T12V-20L-60LED-W/IP65](#) [LFBHL-SW860-24V-12D83-20](#) [LFBLL-SW860-24V-5S200-20-IC](#) [LFBML-MW827860-24V-12D83-20](#) [LFBML-SW827-24V-6S167-20](#) [LM-SAG1-W2](#) [LMV-MINI-W2](#) [LS-2835W120RN](#) [LS-2835W120RN1](#) [LS-2835W60RN2](#) [LS-2835WW120R-1](#) [LS-2835WW60RN](#) [LS-3014WW60RN](#) [LS-3014WW60RN3](#) [LS-3528W60RN-1](#) [LS-3528W60RN-2](#) [LS-5050F60R-2](#) [LS-5050F60RN-3](#) [LS-5050W30RN](#)