

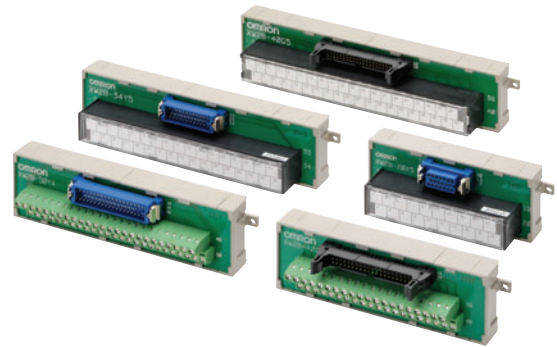





Simplifies Connector and terminal block replacement, and requires less in-panel wiring.

- Mount to DIN Track or via screws.
- MIL Flat Cable Connectors and Multi-pole, Square Connectors are standard.
- Terminal blocks available with either M3 or M3.5 screws.
- Connecting Cables for Programmable Controllers available (sold separately).

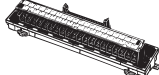
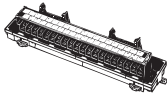
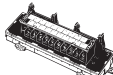

Ordering Information

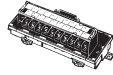
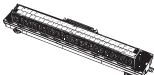
Connectors

Type	Terminal Block	Connector	No. of poles	Appearance	Model
Flat Cable	Terminal block with M3 screws	Flat Cable Connectors *1	20		XW2B-20G4
			34		XW2B-34G4
			40		XW2B-40G4
			50		XW2B-50G4
			60		XW2B-60G4
	Terminal block with M3.5 screws		20		XW2B-20G5
			34		XW2B-34G5
			40		XW2B-40G5
			50		XW2B-50G5
			60		XW2B-60G5
Twin-connector	Terminal block with M3.5 screws	Flat Cable Connectors *1	40		XW2B-40G5-T
Daisy Chain			20		XW2B-20G5-D
Multi-pole, Square Connector	Terminal block with M3 screws	Multi-pole, Square Connector Plugs *2	20		XW2B-20Y4
			34		XW2B-34Y4
			50		XW2B-50Y4
	Terminal block with M3.5 screws		20		XW2B-20Y5
			34		XW2B-34Y5
			50		XW2B-50Y5
	Terminal block with M3.5 screws	Multi-pole, Square Connector Plugs *2	20		XW2B-20X5
			34		XW2B-34X5
			50		XW2B-50X5
Board I/O	Terminal block with M3.5 screws	Multi-pole, Square Connector Plugs *3	40		XW2B-40F5-P

*1. Flat Cable Connectors have one polarity slot.

*2. These Plugs and Sockets are made by Honda Tsushin Kogyo.

*3. These Plugs are made by Fujitsu component.

Accessories (Order Separately)

Connecting Cables for Connector-Terminal Block Conversion Units

For details on the Connecting Cable used between XW2B Daisy Chain-type Connectors, refer to the *XW2Z datasheet*.

Ratings and Specifications

Item	Type	XW2B-□□G□ Flat Cable Units	XW2B-□□Y□ Multi-pole, Square-connector Units	XW2B-40F5-P Board I/O Unit
Rated current		1 A		
Rated voltage		125 VAC		
Insulation resistance		100 MΩ min. (at 500 VDC)		
Dielectric strength		500 VAC for 1 min (leakage current: 1 mA max.)		
Ambient operating temperature		0 to 55°C		

Dimensions

(Unit: mm)

Flat Cable Units with a Terminal Block with M3 Screws

XW2B-□□G4

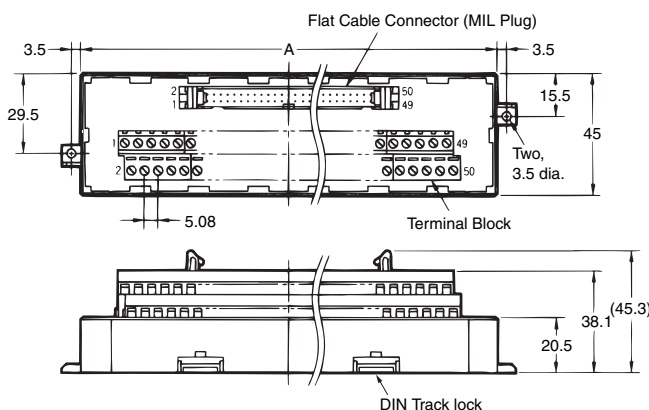
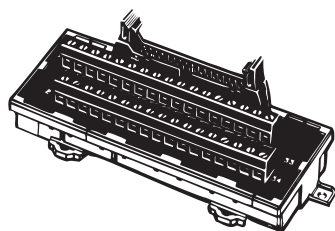

Wiring Diagram

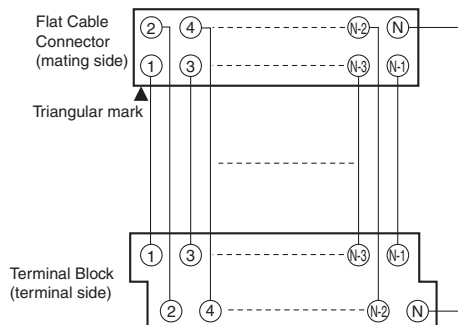

Note: All pins on the Flat Cable Connector correspond 1-to-1 to the terminal of the same number on the terminal block as shown above.

Dimensions

Model	No. of poles	Dimension A (mm)	Applicable Connector models *1
XW2B-20G4	20	67.5	XG4A-2031
XW2B-34G4	34	112.5	XG4A-3431
XW2B-40G4	40	135.0	XG4A-4031
XW2B-50G4	50	157.5	XG4A-5031
XW2B-60G4	60	180.0	XG4A-6031

*Flat Cable Connectors have one polarity slot.

Note: Terminal block pitch is 5.08 mm.

Use a wire size between 0.3 and 1.25 mm² (AWG22 to AWG16).

The wire insertion holes are 1.8 × 2.5 (H × W) mm.

Applicable Connectors

Model	Applicable Connectors (order separately)		
	Flat Cable Connectors, MIL Sockets with Strain Reliefs	Discrete-wire IDC Connectors, Double-row Sockets	
		Connectors *1	Semi-covers *2
XW2B-20G4	XG4M-2030-T	XG5M-2032-N XG5M-2035-N	XG5S-1001
XW2B-34G4	XG4M-3430-T	XG5M-3432-N XG5M-3435-N	XG5S-1701
XW2B-40G4	XG4M-4030-T	XG5M-4032-N XG5M-4035-N	XG5S-2001
XW2B-50G4	XG4M-5030-T	XG5M-5032-N XG5M-5035-N	XG5S-2501
XW2B-60G4	XG4M-6030-T	XG5M-6032-N XG5M-6035-N	XG5S-3001

*1. Either the XG5M-□□32-N or the XG5M-□□35-N may be used.

*2. Each Connector requires two Semi-covers.

Flat Cable Units with a Terminal Block with M3.5 Screws

XW2B-□□G5

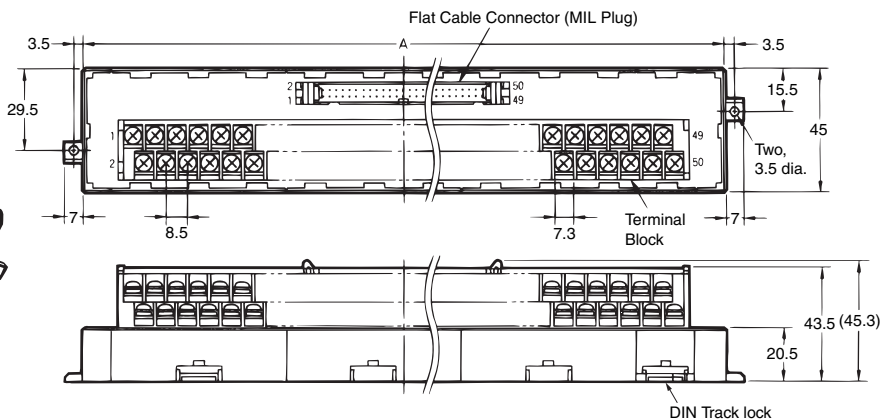
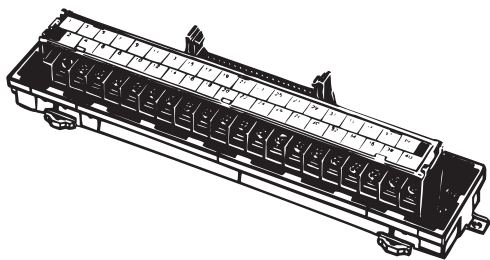

Wiring Diagram

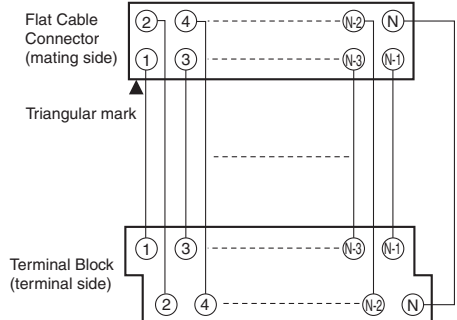

Note: All pins on the Flat Cable Connector correspond 1-to-1 to the terminal of the same number on the terminal block as shown above.

Dimensions

Model	No. of poles	Dimension A (mm)	Applicable Connector models *
XW2B-20G5	20	112.5	XG4A-2031
XW2B-34G5	34	180.0	XG4A-3431
XW2B-40G5	40	202.5	XG4A-4031
XW2B-50G5	50	247.5	XG4A-5031
XW2B-60G5	60	292.5	XG4A-6031

*Flat Cable Connectors have one polarity slot.
Note: Terminal block pitch is 8.5 mm.

Applicable Connectors

Model	Applicable Connectors (order separately)		
	Flat Cable Connectors, MIL Sockets with Strain Reliefs	Discrete-wire IDC Connectors, Double-row Sockets	
		Connectors *1	Semi-covers *2
XW2B-20G5	XG4M-2030-T	XG5M-2032-N XG5M-2035-N	XG5S-1001
XW2B-34G5	XG4M-3430-T	XG5M-3432-N XG5M-3435-N	XG5S-1701
XW2B-40G5	XG4M-4030-T	XG5M-4032-N XG5M-4035-N	XG5S-2001
XW2B-50G5	XG4M-5030-T	XG5M-5032-N XG5M-5035-N	XG5S-2501
XW2B-60G5	XG4M-6030-T	XG5M-6032-N XG5M-6035-N	XG5S-3001

*1. Either the XG5M-□□32-N or the XG5M-□□35-N may be used.
*2. Each Connector requires two Semi-covers.

Twin-connector Units with a Terminal Block with M3.5 Screws

XW2B-40G5-T

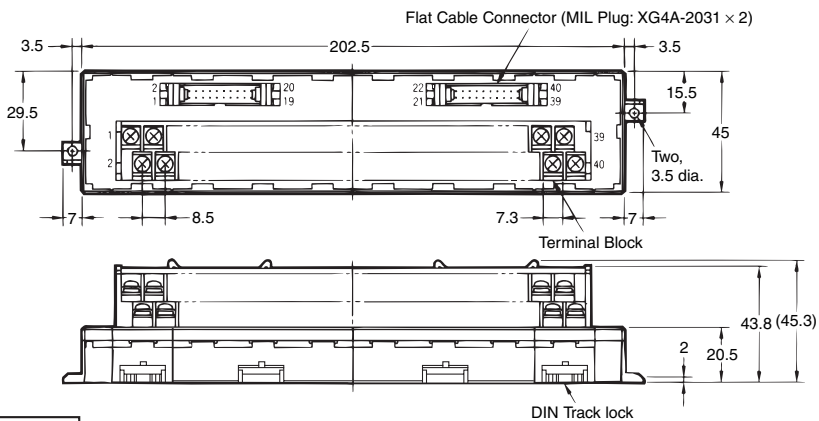
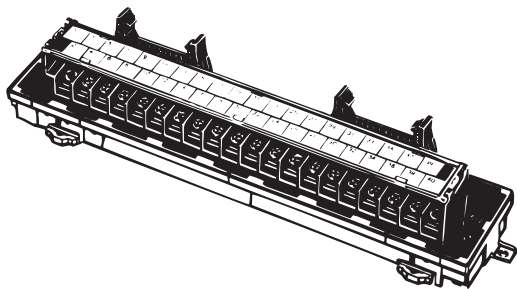

Wiring Diagram

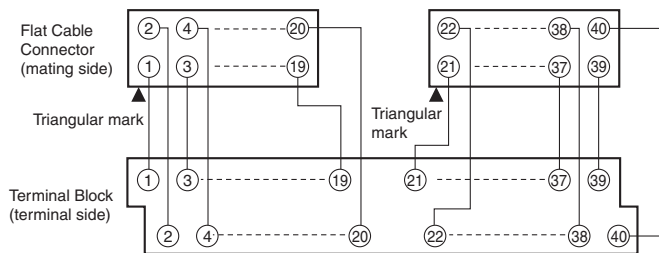

Note: All pins on the Flat Cable Connector correspond 1-to-1 to the terminal of the same number on the terminal block as shown above.

Applicable Connectors

Model	Applicable Connectors (order separately)		
	Flat Cable Connectors, MIL Sockets with Strain Reliefs	Discrete-wire IDC Connectors, Double-row Sockets	
		Connectors *1	Semi-covers *2
XW2B-40G5-T	XG4M-2030-T	XG5M-2032-N XG5M-2035-N	XG5S-1001

*1. Either the XG5M-□□32-N or the XG5M-□□35-N may be used.

*2. Each Connector requires two Semi-covers.

Daisy Chain Units with a Terminal Block with M3.5 Screws

XW2B-20G5-D

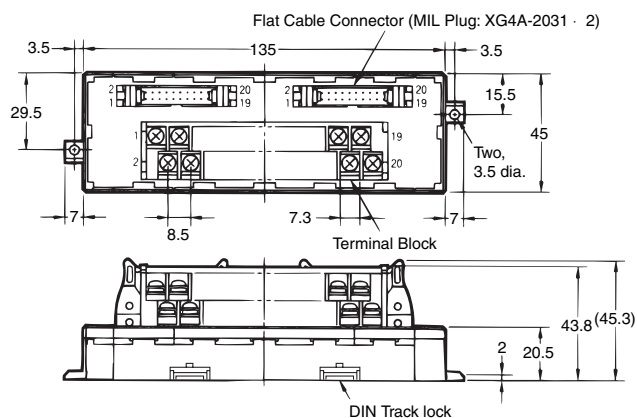
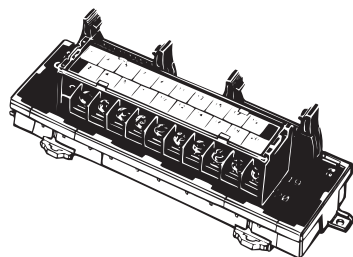

Wiring Diagram

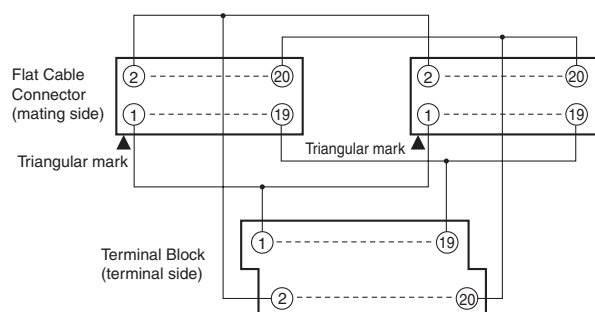

Note: All pins on the Flat Cable Connector correspond 1-to-1 to the terminal of the same number on the terminal block as shown above.

Applicable Connectors

Model	Applicable Connectors (order separately)		
	Flat Cable Connectors, MIL Sockets with Strain Reliefs	Discrete-wire IDC Connectors, Double-row Sockets	
		Connectors *1	Semi-covers *2
XW2B-20G5-D	XG4M-2030-T	XG5M-2032-N XG5M-2035-N	XG5S-1001

*1. Either the XG5M-□□32-N or the XG5M-□□35-N may be used.

*2. Each Connector requires two Semi-covers.

Multi-pole, Square-connector Plug Units with a Terminal Block with M3 Screws

XW2B-□□Y4

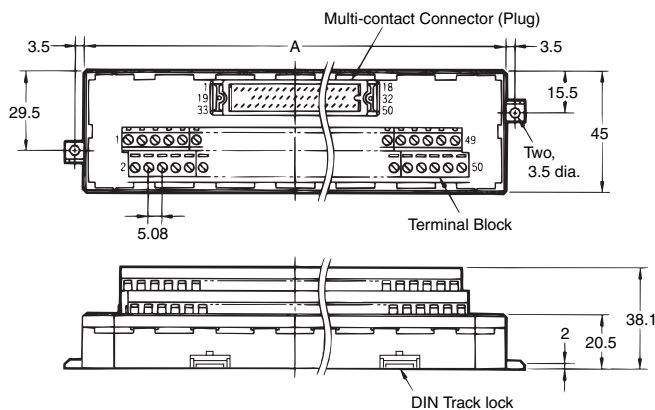
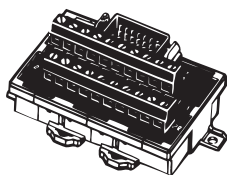

Wiring Diagram (Example for Terminal Block with 50 Poles)

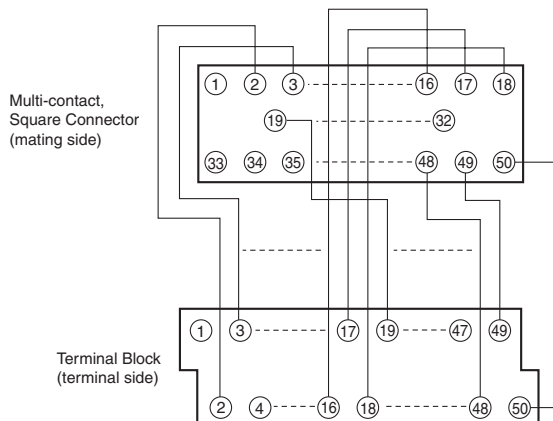

Note: All pins on the Multi-pole, Square Connector correspond 1-to-1 to the terminal of the same number on the terminal block as shown above.

Dimensions

Model	No. of poles	Dimension A (mm)	Applicable Connector models *
XW2B-20Y4	20	67.5	MR-20RMD2
XW2B-34Y4	34	112.5	MR-34RMD2
XW2B-50Y4	50	157.5	MR-50RMD2

*These Connectors are made by Honda Tsushin Kogyo.
 Note: Terminal block pitch is 5.08 mm.
 Use a wire size between 0.3 and 1.25 mm² (AWG22 to AWG16).
 The wire insertion holes are 1.8 × 2.5 (H × W) mm.

Applicable Connectors

Model	Applicable Connectors *1	Hood *1
XW2B-20Y4	MR-20F (soldered) MRP-20F01 (crimped) *2 MR-20FW (wrapped)	MR-20L
XW2B-34Y4	MR-34F (soldered) MRP-34F01 (crimped) *2 MR-34FW (wrapped)	MR-34L
XW2B-50Y4	MR-50F (soldered) MRP-50F01 (crimped) *2 MR-50FW (wrapped)	MR-50L

*1. All applicable Connector Hoods are made by Honda Tsushin Kogyo.
 *2. Use MRP-F113 or MRP-F103 crimp terminals made by Honda Tsushin Kogyo.

Multi-pole, Square-connector Plug Units with a Terminal Block with M3.5 Screws

XW2B-□□Y5

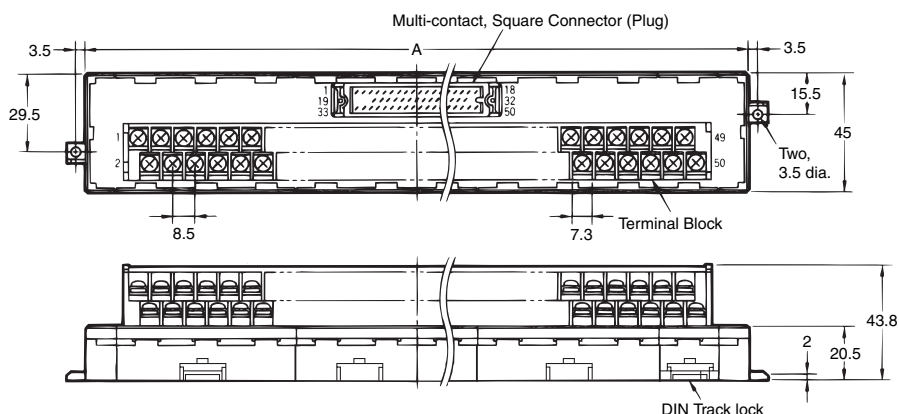
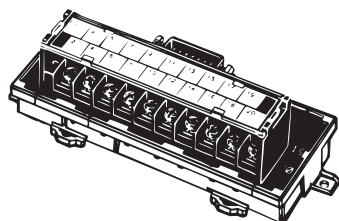

Wiring Diagram (Example for Terminal Block with 50 Poles)

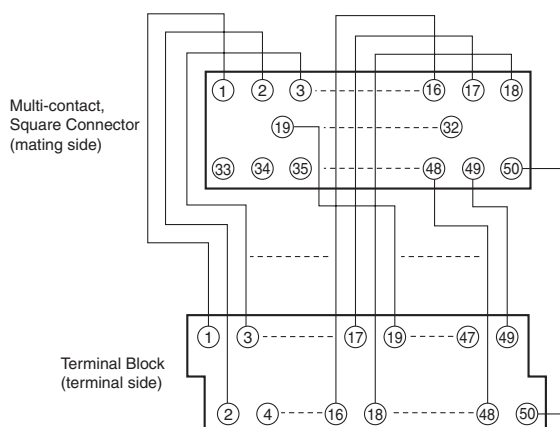

Note: All pins on the Multi-pole, Square Connector correspond 1-to-1 to the terminal of the same number on the terminal block as shown above.

Dimensions

Model	No. of poles	Dimension A (mm)	Applicable Connector models *
XW2B-20Y5	20	112.5	MR-20RMD2
XW2B-34Y5	34	180.0	MR-34RMD2
XW2B-50Y5	50	247.5	MR-50RMD2

*These Connectors are made by Honda Tsushin Kogyo.
Note: Terminal block pitch is 8.5 mm.

Applicable Connectors

Model	Applicable Connectors *1	Hood *1
XW2B-20Y5	MR-20F (soldered) MRP-20F01 (crimped) *2 MR-20FW (wrapped)	MR-20L
XW2B-34Y5	MR-34F (soldered) MRP-34F01 (crimped) *2 MR-34FW (wrapped)	MR-34L
XW2B-50Y5	MR-50F (soldered) MRP-50F01 (crimped) *2 MR-50FW (wrapped)	MR-50L

*1. All applicable Connector Hoods are made by Honda Tsushin Kogyo.

*2. Use MRP-F113 or MRP-F103 crimp terminals made by Honda Tsushin Kogyo.

Multi-pole, Square Connector Socket Units with a Terminal Block with M3.5 Screws

XW2B-□□X5

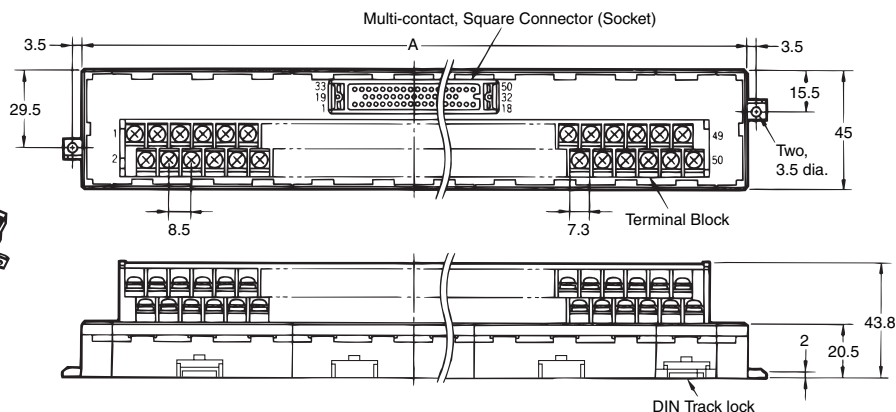
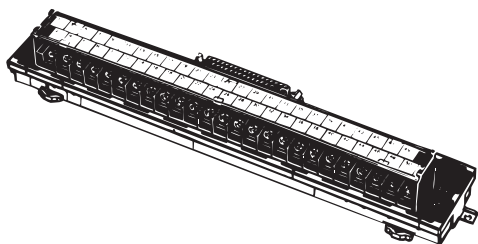

Wiring Diagram (Example for Terminal Block with 50 Poles)

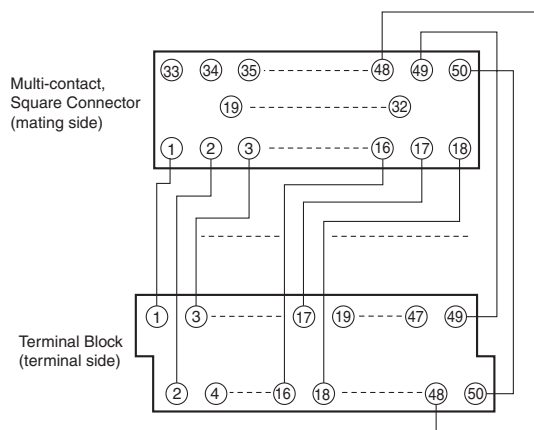

Note: All pins on the Multi-pole, Square Connector correspond 1-to-1 to the terminal of the same number on the terminal block as shown above.

Dimensions

Model	No. of poles	Dimension A (mm)	Applicable Connector models *
XW2B-20X5	20	112.5	MR-20RFD2
XW2B-34X5	34	180.0	MR-34RFD2
XW2B-50X5	50	247.5	MR-50RFD2

*These Connectors are made by Honda Tsushin Kogyo.
Note: Terminal block pitch is 8.5 mm.

Applicable Connectors

Model	Applicable Connectors *1	Hood *1
XW2B-20X5	MR-20M (soldered) MRP-20M01 (crimped) *2 MR-20MW (wrapped)	MR-20L
XW2B-34X5	MR-34M (soldered) MRP-34M01 (crimped) *2 MR-34MW (wrapped)	MR-34L
XW2B-50X5	MR-50M (soldered) MRP-50M01 (crimped) *2 MR-50MW (wrapped)	MR-50L

*1. All applicable Connector Hoods are made by Honda Tsushin Kogyo.

*2. Use MRP-F113 or MRP-F103 crimp terminals made by Honda Tsushin Kogyo.

Board I/O Units with a Terminal Block with M3.5 Screws

XW2B-40F5-P

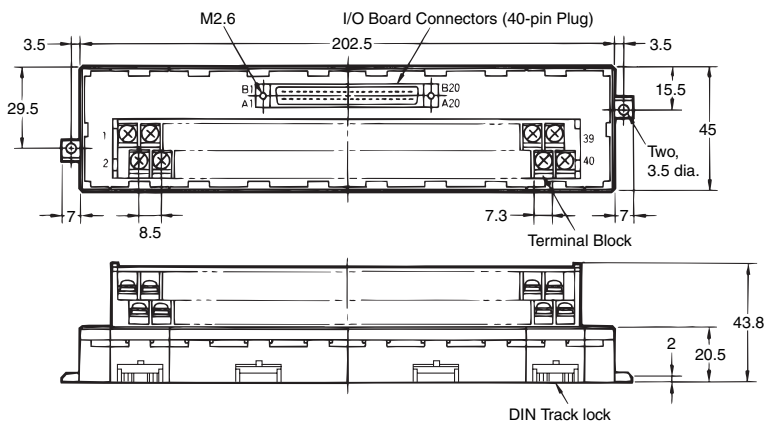
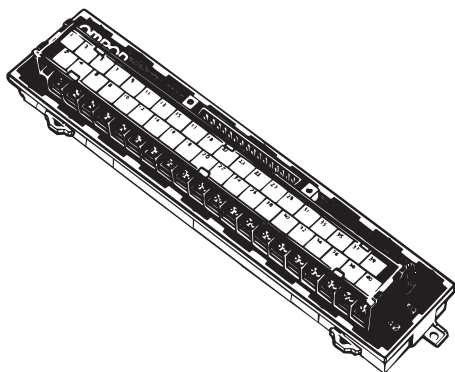

Wiring Diagram

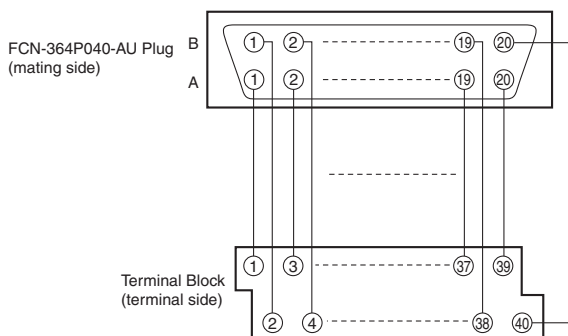

Dimensions

Model	No. of poles	Applicable Connectors and Circuits *
XW2B-40F5-P	40	FCN-364P40-AU (Connector) FCN-360A1 (Anchor)

*These Connectors and circuits are made by Fujitsu component.
Note: Terminal block pitch is 8.5 mm.

Applicable Connectors

Model	Applicable Connectors *1	Hood *1
XW2B-40F5-P	FCN361J040-AU (soldered) FCN363J040-AAU (crimped)	FCN360C040-B

*1. All applicable Connectors and Covers are made by Fujitsu component.

*2. Refer to the *OMNUC U Series user's manual* for details on the Connecting Cable used between the XW2B-40F5-P and the U-series AC Servo Driver.

Safety Precautions

Precautions for Correct Use

● Wiring

- Always turn OFF the power supply before wiring. Otherwise, cables or other conductors can short the terminals and cause the Unit to fail.
- Do not connect or disconnect Connectors with the power turned ON. Otherwise, it may cause malfunctions.

● Wiring Terminal Blocks

- Direct Wire Connections with a Terminal Block with M3 Screws
 - Use a wire size between 0.3 and 1.25 mm² (AWG22 to AWG16).
 - Prepare the end of each wire as shown in the following diagram.



- The wire insertion holes are 1.8 × 2.5 (H × W) mm on the terminal block with M3 screws.

- Direct Wire Connections with a Terminal Block with M3.5 Screws

Round

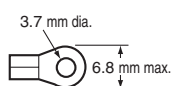

Forked

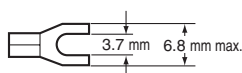

	Applicable crimp terminals	Applicable wires
Round	1.25-3.5	AWG22 to AWG16 (0.30 to 1.25 mm ²)
	2-3.5	AWG16 to AWG14 (1.25 to 2.0 mm ²)
Forked	1.25Y-3.5	AWG22 to AWG16 (0.30 to 1.25 mm ²)
	2Y-3.5	AWG16 to AWG14 (1.25 to 2.0 mm ²)

(With a Terminal Block with M3 Screws)

Round rod

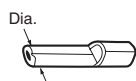

Blade

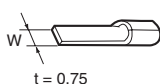

	Applicable crimp terminals	Applicable wires
Rod	TC-05 Dia. = 1	AWG22 to AWG18 (0.30 to 0.75 mm ²)
	TC-1.25S Dia. = 1.5	AWG22 to AWG16 (0.30 to 1.25 mm ²)
Blade	BT1.25-9-1 BT1.25-10-1 W = 2.2	AWG22 to AWG16 (0.30 to 1.25 mm ²)

Note: Round rod and blade crimp terminals are made by Nichifu.

● Terminal Screw Tightening Torque

- Select a tightening torque from the following table when connecting wires or crimp terminals to the terminal block.

Terminal Block	Tightening torque N·m
With M3 screws	0.40
With M3.5 screws	0.59

● Mounting Units to and Removing Units from DIN Track

- For terminal blocks with M3 screws, use a flat-head screwdriver like the one shown in the following diagram.

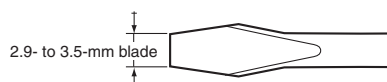

- XW2B Connector-Terminal Block Conversion Units can be mounted side-to-side on DIN Track. The flanges for mounting screws are located on each side at the bottom of the XW2B.
- Secure both ends of the XW2B with End Plates.
- When removing the Unit from a DIN Track, insert a flat-head screwdriver into the slider and pull the lock out.

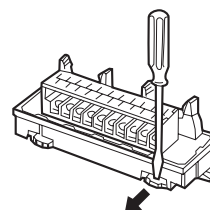

Read and Understand This Catalog

Please read and understand this catalog before purchasing the products. Please consult your OMRON representative if you have any questions or comments.

Warranty and Limitations of Liability

WARRANTY

OMRON's exclusive warranty is that the products are free from defects in materials and workmanship for a period of one year (or other period if specified) from date of sale by OMRON.

OMRON MAKES NO WARRANTY OR REPRESENTATION, EXPRESS OR IMPLIED, REGARDING NON-INFRINGEMENT, MERCHANTABILITY, OR FITNESS FOR PARTICULAR PURPOSE OF THE PRODUCTS. ANY BUYER OR USER ACKNOWLEDGES THAT THE BUYER OR USER ALONE HAS DETERMINED THAT THE PRODUCTS WILL SUITABLY MEET THE REQUIREMENTS OF THEIR INTENDED USE. OMRON DISCLAIMS ALL OTHER WARRANTIES, EXPRESS OR IMPLIED.

LIMITATIONS OF LIABILITY

OMRON SHALL NOT BE RESPONSIBLE FOR SPECIAL, INDIRECT, OR CONSEQUENTIAL DAMAGES, LOSS OF PROFITS OR COMMERCIAL LOSS IN ANY WAY CONNECTED WITH THE PRODUCTS, WHETHER SUCH CLAIM IS BASED ON CONTRACT, WARRANTY, NEGLIGENCE, OR STRICT LIABILITY.

In no event shall the responsibility of OMRON for any act exceed the individual price of the product on which liability is asserted.

IN NO EVENT SHALL OMRON BE RESPONSIBLE FOR WARRANTY, REPAIR, OR OTHER CLAIMS REGARDING THE PRODUCTS UNLESS OMRON'S ANALYSIS CONFIRMS THAT THE PRODUCTS WERE PROPERLY HANDLED, STORED, INSTALLED, AND MAINTAINED AND NOT SUBJECT TO CONTAMINATION, ABUSE, MISUSE, OR INAPPROPRIATE MODIFICATION OR REPAIR.

Application Considerations

SUITABILITY FOR USE

OMRON shall not be responsible for conformity with any standards, codes, or regulations that apply to the combination of products in the customer's application or use of the products.

At the customer's request, OMRON will provide applicable third party certification documents identifying ratings and limitations of use that apply to the products. This information by itself is not sufficient for a complete determination of the suitability of the products in combination with the end product, machine, system, or other application or use.

The following are some examples of applications for which particular attention must be given. This is not intended to be an exhaustive list of all possible uses of the products, nor is it intended to imply that the uses listed may be suitable for the products:

- Outdoor use, uses involving potential chemical contamination or electrical interference, or conditions or uses not described in this catalog.
- Nuclear energy control systems, combustion systems, railroad systems, aviation systems, medical equipment, amusement machines, vehicles, safety equipment, and installations subject to separate industry or government regulations.
- Systems, machines, and equipment that could present a risk to life or property.

Please know and observe all prohibitions of use applicable to the products.

NEVER USE THE PRODUCTS FOR AN APPLICATION INVOLVING SERIOUS RISK TO LIFE OR PROPERTY WITHOUT ENSURING THAT THE SYSTEM AS A WHOLE HAS BEEN DESIGNED TO ADDRESS THE RISKS, AND THAT THE OMRON PRODUCTS ARE PROPERLY RATED AND INSTALLED FOR THE INTENDED USE WITHIN THE OVERALL EQUIPMENT OR SYSTEM.

PROGRAMMABLE PRODUCTS

OMRON shall not be responsible for the user's programming of a programmable product, or any consequence thereof.

Disclaimers

CHANGE IN SPECIFICATIONS

Product specifications and accessories may be changed at any time based on improvements and other reasons.

It is our practice to change model numbers when published ratings or features are changed, or when significant construction changes are made. However, some specifications of the products may be changed without any notice. When in doubt, special model numbers may be assigned to fix or establish key specifications for your application on your request. Please consult with your OMRON representative at any time to confirm actual specifications of purchased products.

DIMENSIONS AND WEIGHTS

Dimensions and weights are nominal and are not to be used for manufacturing purposes, even when tolerances are shown.

PERFORMANCE DATA

Performance data given in this catalog is provided as a guide for the user in determining suitability and does not constitute a warranty. It may represent the result of OMRON's test conditions, and the users must correlate it to actual application requirements. Actual performance is subject to the OMRON Warranty and Limitations of Liability.

ERRORS AND OMISSIONS

The information in this document has been carefully checked and is believed to be accurate; however, no responsibility is assumed for clerical, typographical, or proofreading errors, or omissions.

2012.4

In the interest of product improvement, specifications are subject to change without notice.

OMRON Corporation
Industrial Automation Company

<http://www.ia.omron.com/>

(c)Copyright OMRON Corporation 2012 All Right Reserved.

X-ON Electronics

Largest Supplier of Electrical and Electronic Components

Click to view similar products for [Terminal Block Interface Modules](#) category:

Click to view products by [Omron](#) manufacturer:

Other Similar products are found below :

[73-551-6002I](#) [GCN1MX25B](#) [11S](#) [DIN-50P-01](#) [DIN-68H-01](#) [DIN-96DI-01](#) [2291901](#) [2900185](#) [2903392](#) [2907794](#) [2M10FCL](#) [2281759](#)
[2906249](#) [2907808](#) [TB ML 3P ST D5.08](#) [5604442](#) [XW2B-40G5-T](#) [5606629](#) [XW2B-20G5-D](#) [2903870](#) [5541988](#) [5541962](#) [1776613-1](#) [XW2B-](#)
[34G4](#) [XW2B-60G5](#) [XW2R-E34G-C1](#) [XW2R-E34G-C3](#) [XW2R-J40G-T](#) [XW2R-P34G-C4](#) [XW2B-50G5](#) [XW2R-E40G-T](#) [XW2R-E34G-C2](#)
[XW2R-J34G-C2](#) [ADAM-3920R-AE](#) [060-6827-06](#) [2311030](#) [2287708](#) [XW2C-20G6-IO16](#) [XW2R-J20G-T](#) [XW2B-60G4](#) [GCN1-T](#)
[00111550102](#) [2908853](#) [2908851](#) [2908852](#) [2908850](#) [1033201](#) [5541234](#) [410-261](#) [5521322](#)