

### 3.5 mm×2.9 mm Side-operational SMD Light Touch Switches

Type: **EVQP7/EVQP3/EVQ9P7**

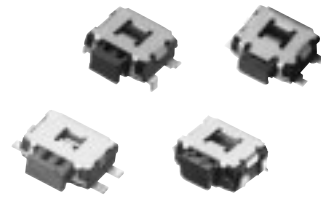

#### ■ Features

- External dimensions : 3.5 mm×2.9 mm, Height 1.35 mm
- A wide range of terminal type : L-shape, J-bent, Straight
- High mount ability
- Push plate strength enhanced type

#### ■ Recommended Applications

- Car navigation, Car audio

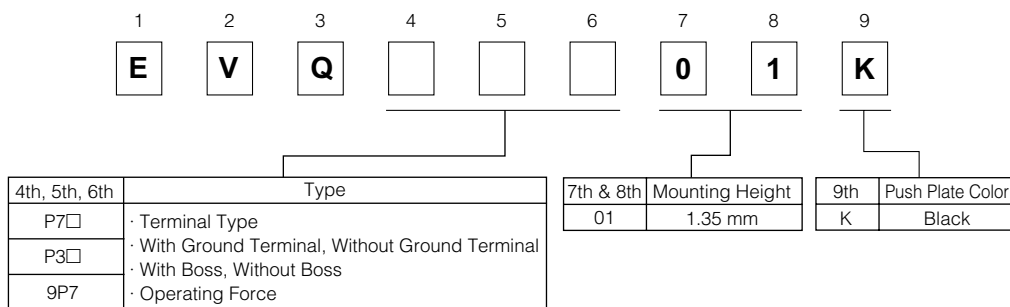

#### ■ Explanation of Part Numbers



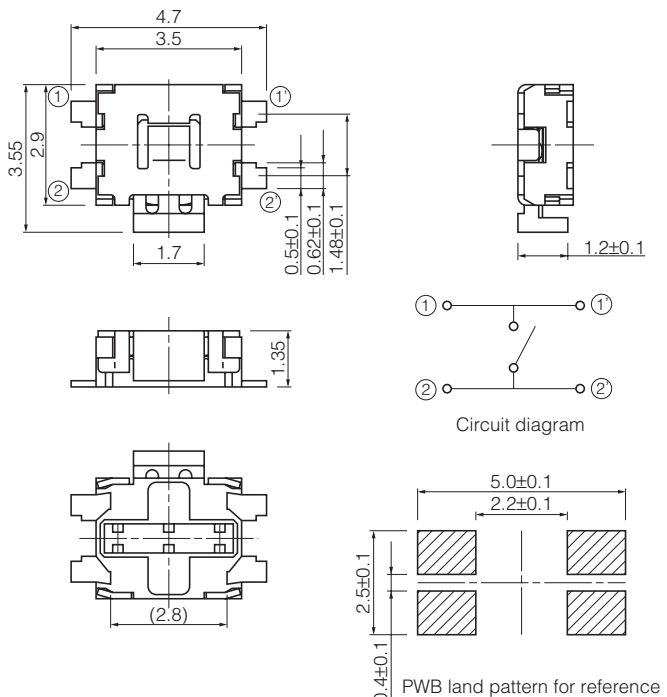

#### ■ Specifications

Type	Snap action / Push-on type SPST	
Electrical	Rating	10 $\mu$ A 2 Vdc to 50 mA 12 Vdc (Resistive load)
	Contact Resistance	500 m $\Omega$ max.
	Insulation Resistance	100 M $\Omega$ min. (at 100 Vdc)
	Dielectric Withstanding Voltage	250 Vac (1 minute)
	Bouncing	10 ms max. (ON, OFF)
Mechanical	Operating Force	1.6 N, 2.2 N
	Push Travel	0.2 mm
	Push Strength	30 N (1 minute)
Endurance	Operating Life	100000 cycles min.
Operating Temperature		-20 °C to +70 °C
Storage Temperature		-40 °C to +85 °C (Bulk)
		-20 °C to +60 °C (Taping)
Minimum Quantity/Packing Unit		5000 pcs. Embossed Taping (Reel Pack)
Quantity/Carton		25000 pcs.

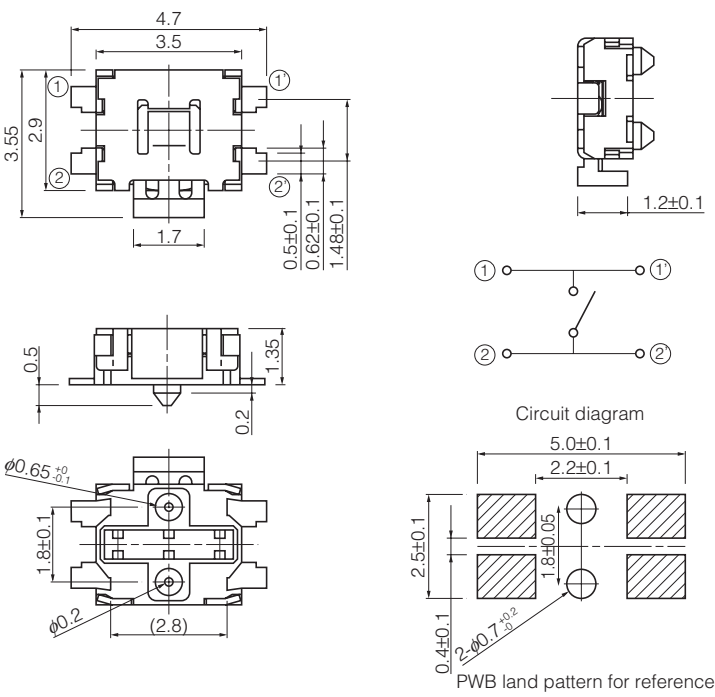
■ Dimensions in mm (not to scale)

<p>No. 1</p> <p>EVQP7A EVQP7J</p> <p>(Embossed Taping)</p> <p>With straight terminals Without boss</p> 				
<p>Part Numbers</p>	<p>Operating Force</p>	<p>Height</p>	<p>Push Plate Color</p>	<p>Operating Life</p>
<p>EVQP7A01K</p>	<p>2.2 N</p>	<p>1.35 mm</p>	<p>Black</p>	<p>100000 cycles</p>
<p>EVQP7J01K</p>	<p>1.6 N</p>	<p>1.35 mm</p>	<p>Black</p>	<p>100000 cycles</p>
<p>No. 2</p> <p>EVQP7C EVQP7L</p> <p>(Embossed Taping)</p> <p>With straight terminals With boss</p> 				
<p>Part Numbers</p>	<p>Operating Force</p>	<p>Height</p>	<p>Push Plate Color</p>	<p>Operating Life</p>
<p>EVQP7C01K</p>	<p>2.2 N</p>	<p>1.35 mm</p>	<p>Black</p>	<p>100000 cycles</p>
<p>EVQP7L01K</p>	<p>1.6 N</p>	<p>1.35 mm</p>	<p>Black</p>	<p>100000 cycles</p>

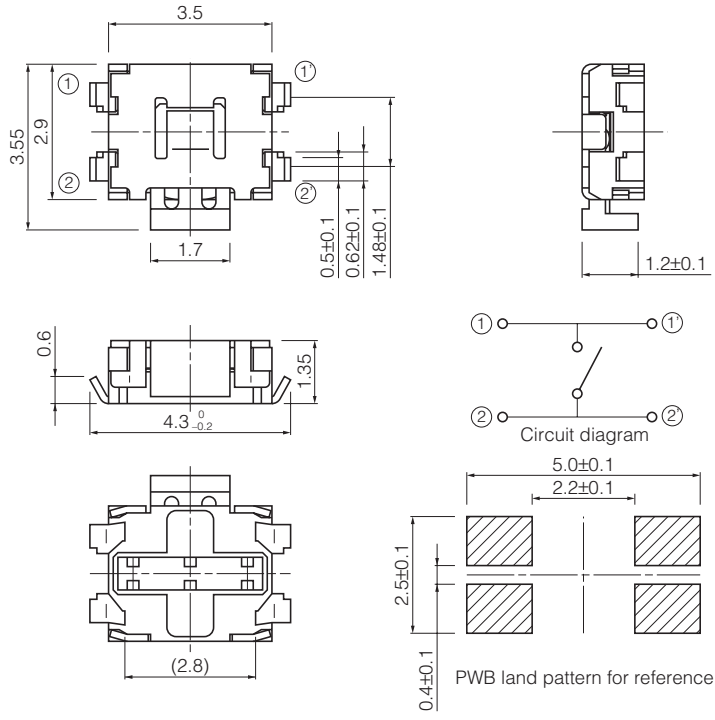
### ■ Dimensions in mm (not to scale)

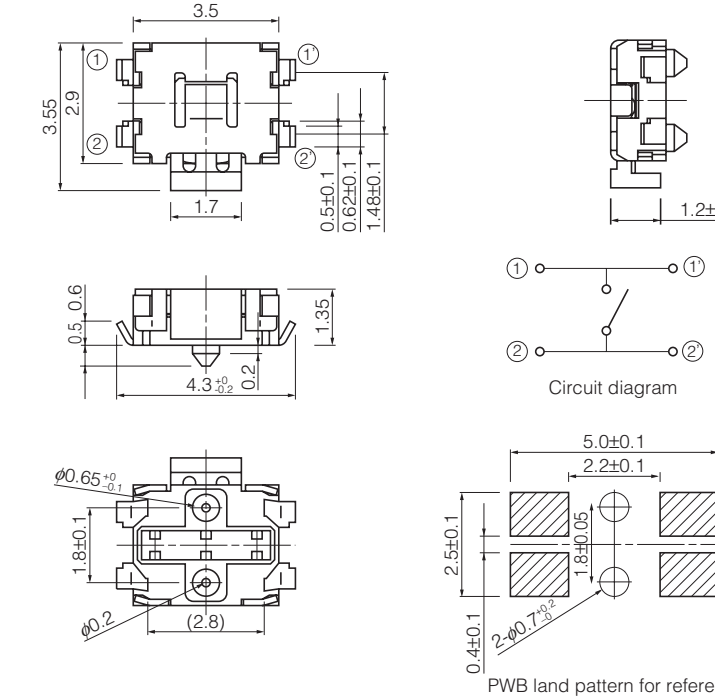
<p>No. 3</p> <p>EVQP7B EVQP7K</p> <p>(Embossed Taping)</p> <p>With J-bent terminals Without boss</p> 				
<p>Part Numbers</p>	<p>Operating Force</p>	<p>Height</p>	<p>Push Plate Color</p>	<p>Operating Life</p>
<p>EVQP7B01K</p>	<p>2.2 N</p>	<p>1.35 mm</p>	<p>Black</p>	<p>100000 cycles</p>
<p>EVQP7K01K</p>	<p>1.6 N</p>	<p>1.35 mm</p>	<p>Black</p>	<p>100000 cycles</p>
<p>No. 4</p> <p>EVQP7D EVQP7M</p> <p>(Embossed Taping)</p> <p>With J-bent terminals With boss</p> 				
<p>Part Numbers</p>	<p>Operating Force</p>	<p>Height</p>	<p>Push Plate Color</p>	<p>Operating Life</p>
<p>EVQP7D01K</p>	<p>2.2 N</p>	<p>1.35 mm</p>	<p>Black</p>	<p>100000 cycles</p>
<p>EVQP7M01K</p>	<p>1.6 N</p>	<p>1.35 mm</p>	<p>Black</p>	<p>100000 cycles</p>

### ■ Dimensions in mm (not to scale)

No. 5 EVQP3 EVQ9P (Embossed Taping) With L-shape terminals Without boss				
Part Numbers	Operating Force	Height	Push Plate Color	Operating Life
EVQP3401K	2.2 N	1.35 mm	Black	100000 cycles
EVQ9P701K	1.6 N	1.35 mm	Black	100000 cycles

### ■ Recommended Reflow Soldering Conditions

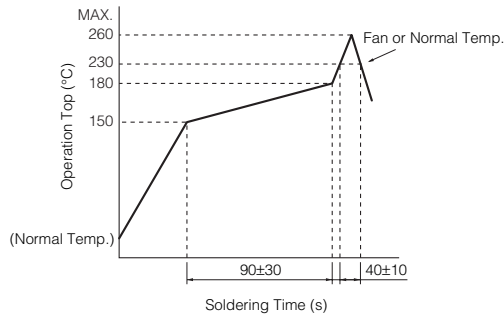

### ● Embossed Carrier Taping

Tape width=12.0 mm

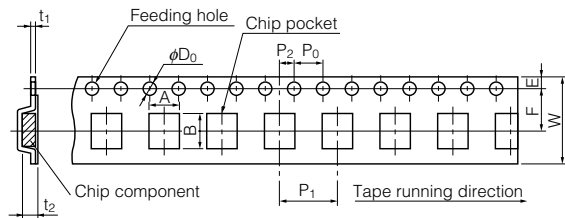

### ● Straight terminals, L-shape terminals type

Unit: mm

Part No.	Height	A	B	W	F	E	P <sub>1</sub>	P <sub>2</sub>	P <sub>0</sub>	D <sub>0</sub> Dia.	t <sub>1</sub>	t <sub>2</sub>
EVQP7, EVQP3 EVQ9P7	1.35	5.2±0.2	4.5±0.2	12.0±0.3	5.5±0.1	1.75±0.10	8.0±0.1	2.0±0.1	4.0±0.1	1.5 <sup>+0.1</sup> <sub>-0</sub>	0.3±0.1	1.5±0.2

### ● J-bent type

Unit: mm

Part No.	Height	A	B	W	F	E	P <sub>1</sub>	P <sub>2</sub>	P <sub>0</sub>	D <sub>0</sub> Dia.	t <sub>1</sub>	t <sub>2</sub>
EVQP7, EVQP3	1.35	4.5±0.2	4.5±0.2	12.0±0.3	5.5±0.1	1.75±0.10	8.0±0.1	2.0±0.1	4.0±0.1	1.5 <sup>+0.1</sup> <sub>-0</sub>	0.3±0.1	1.5±0.2

### ● Standard Reel Dimensions in mm (not to scale)

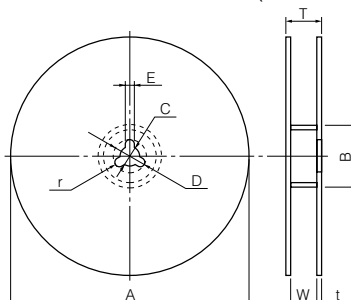

Item	A	B	C	D	E
Rate (mm)	φ380.0±2.0	φ80.0±1.0	φ13.0±0.5	φ21.0±1.0	2.0±0.5
Item	W	T	t	r	
Rate (mm)	13.5±1.0	17.5±1.0	1.0 to 3.0	1.0±0.5	

## X-ON Electronics

Largest Supplier of Electrical and Electronic Components

*Click to view similar products for [Tactile Switches](#) category:*

*Click to view products by [Panasonic](#) manufacturer:*

Other Similar products are found below :

[KMR633NG LFG](#) [5GTH9202242](#) [6426-201-11343](#) [MJ1226](#) [MJTP1109B](#) [MJTP1138EAUTR](#) [MJTP1230BL](#) [MJTPSHW](#) [GS6.90F300QP](#) [1-1977223-0](#) [1-1977120-4](#) [ADTSA62NV](#) [ADTSA62RV](#) [ADTSA63KV](#) [ADTSA644NV](#) [ADTSM24NVTR](#) [ADTSMW66NV](#) [ADTSMW67RV](#) [ATM533VTR](#) [1571300-3](#) [B3F-3123](#) [B3F-6055A](#) [B3F-B32-01-KIT](#) [1977177-8](#) [1977266-1](#) [2-1977223-4](#) [2-1977223-7](#) [ADTS644KV](#) [ADTSA61RV](#) [ADTSA62KV](#) [ADTSA63NV](#) [ADTSA63RV](#) [ADTSA65NV](#) [ADTSM21NSVTR](#) [ADTSM25RVTR](#) [ADTSM31RVTR](#) [ADTSM32NVTR](#) [ADTSM61YVTR](#) [ADTSM63SVTR](#) [ADTSM644KVTR](#) [ADTSMW64RV](#) [ADTSMW69NV](#) [FSMRA4JHA04](#) [GS4.70F300QP](#) [D38999/20JJ37SA](#) [TL1105B](#) [TL1105J](#) [ATH447K2Q](#) [ATM534VTR](#) [MJ1215](#)