

3-phase + neutral line filters FN 256

Compact general purpose three-phase and neutral line EMC filter

SCHAFFNER
energy efficiency and reliability



- Three-phase and neutral line filter for general purpose four-wire filtering
- Compact space-saving design
- Choice of connection style
- Low operating leakage current

Approvals



Technical specifications

Maximum continuous operating voltage:	3x 480/277VAC
Operating frequency:	dc to 60Hz
Rated currents:	8 to 160A @ 50°C
High potential test voltage:	P → E 2650VDC for 2 sec P → P 2100VDC for 2 sec
Protection category:	IP20
Overload capability:	IP00 (filters with connectors -28) 4x rated current at switch on, 1.5x rated current for 1 minute, once per hour
Temperature range (operation and storage):	-25°C to +100°C (25/100/21)
Flammability corresponding to:	UL 94V-2 or better
Design corresponding to:	UL 1283, CSA 22.2 No. 8 1986, IEC/EN 60939
MTBF @ 50°C/400V (Mil-HB-217F):	600,000 hours

Typical electrical schematic

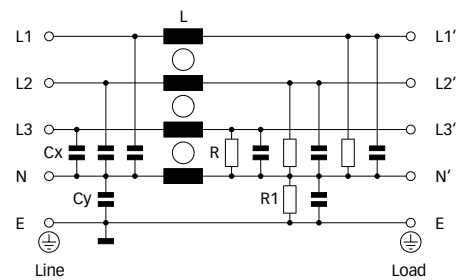



Features and benefits

- FN 256 filters are designed specifically for applications involving asymmetric loads, ranging from industrial controls to medical electronics systems. These typically involve insufficiently filtered converters and switch-mode power supplies on different phases, causing current imbalance and significant interference problems.
- Employing single-stage filter circuits for each phase and the neutral line, FN 256 filters provide high attenuation of both symmetrical and asymmetrical interference.
- Used as a mains input filter, FN 256 filters also increase conducted immunity and thus contribute to overall system reliability.
- Choice of connection style as well as filter ratings in line with common fuse values support a fast and easy application-specific filter selection and deployment.
- A light weight aluminium housing with a small footprint ensures that the filters can be easily accommodated on control panels and in tight power cabinets.

Typical applications

- General purpose four-wire filtering
- High-power office equipment
- Power supplies
- UPS
- Medical applications
- Electrical cabinets
- Control panels

Filter selection table

Filter*	Rated current @ 50°C (40°C)	Leakage current** @ 400VAC/50Hz	Power loss @ 25°C/50Hz	Input/Output connections		Weight [kg]
	[A]	[mA]	[W]			
FN 256-8-46	8 (8.8)	3.4	2.7	-46		0.8
FN 256-16-46	16 (17.5)	3.4	6.0	-46		1.1
FN 256-25-47	25 (27)	3.4	11.6	-47		1.4
FN 256-36-47	36 (39)	3.4	14.8	-47		1.5
FN 256-64-52	64 (70)	3.4	18.4	-52		2.2
FN 256-80-..	80 (88)	3.4	18.8		-28***	4.5
FN 256-120-..	120 (131)	5.0	25.1		-28***	6.1
FN 256-160-..	160 (175)	6.8	30.7		-28***	8.0

* To compile a complete part number, please replace the -.. with the required I/O connection style.

** Maximum leakage under normal operating conditions, based on the assumption that all three phases and the neutral conductor are connected to the supply and the consumer. In this case, the current will mainly return through the neutral line, not as earth leakage.

*** Filters with -28 connections are rated for 40°C environmental temperature only.

Typical filter attenuation

Per CISPR 17; A = 50Ω/50Ω sym; B = 50Ω/50Ω asym; C = 0.1Ω/100Ω sym; D = 100Ω/0.1Ω sym

8A types

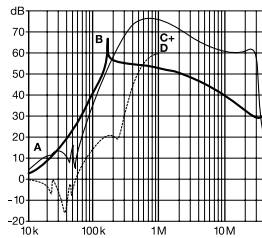

16A types

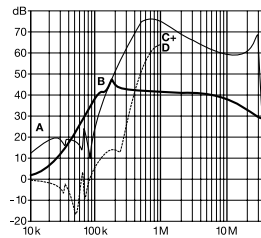

25A types

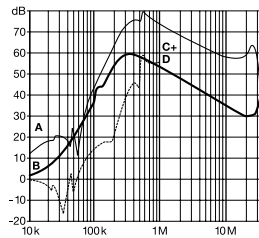

36A types

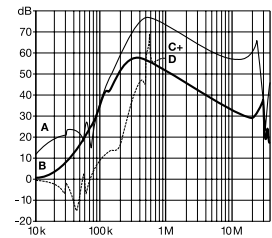

64A types

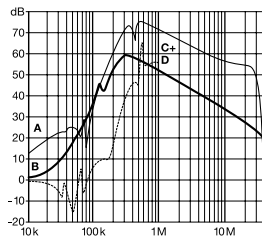

80A types

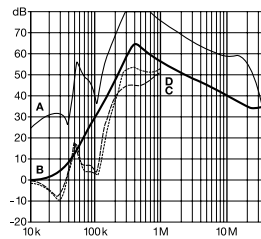

120A types

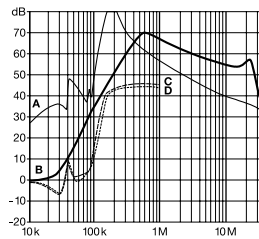

160A types

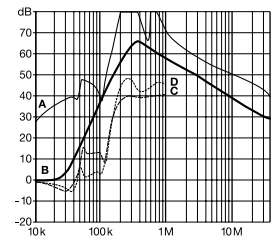

Mechanical data

8 to 64A types

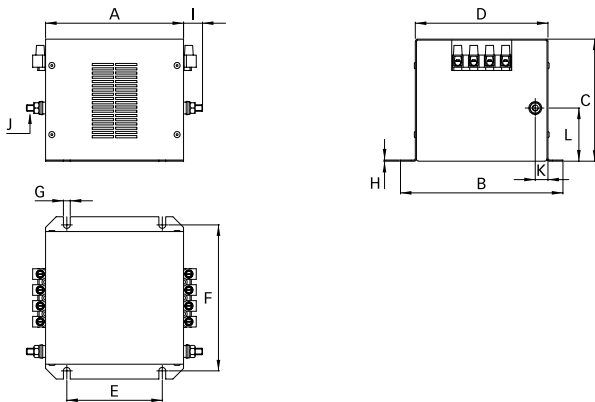

80 to 160A types (-28)

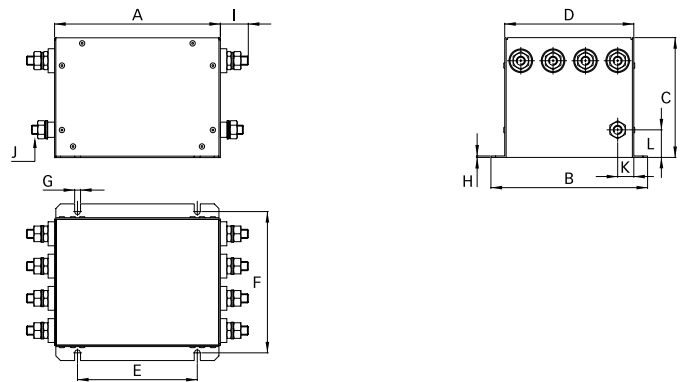

80 to 160A types (-34, -35, -40)

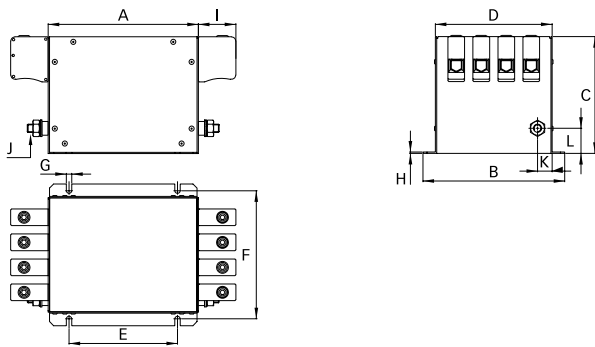

Dimensions

	8A	16A	25A	36A	64A	80A (-28)	80A (-34)	120A (-28)	120A (-35)	160A (-28)	160A (-40)
A	120	120	130	130	140	160	160	180	180	200	200
B	143	143	153	153	153	170	170	170	170	170	170
C	80	80	115	115	125	110	110	130	140	130	160
D	115	115	125	125	125	140	140	140	140	140	140
E	80	80	90	90	100	110	110	130	130	150	150
F	127.5	127.5	137.5	137.5	137.5	153.5	153.5	153.5	153.5	153.5	153.5
G	6.5	6.5	6.5	6.5	6.5	6.5	6.5	6.5	6.5	6.5	6.5
H	1	1	1	1	1.5	1.5	1.5	1.5	1.5	1.5	1.5
I	18	18	18	18	18	33.5	39	33.5	45	33.5	49.5
J	M6	M6	M6	M6	M6	M10	M10	M10	M10	M10	M10
K	12	12	13	13	13	17.5	17.5	17.5	17.5	17.5	17.5
L	33	33	50	50	50	30	30	30	30	30	30

All dimensions in mm; 1 inch = 25.4mm
Tolerances according: ISO 2768-m / EN 22768-m

Filter input/output connector cross sections

	-28 (M10)	-34	-35	-40	-46	-47	-52
Solid wire	n/a	35mm ²	50mm ²	95mm ²	10mm ²	16mm ²	25mm ²
Flex wire	n/a	25mm ²	50mm ²	95mm ²	6mm ²	10mm ²	16mm ²
AWG type wire	n/a	AWG 2	AWG 1/0	AWG 4/0	AWG 10	AWG 8	AWG 4
Recommended torque	15 - 17Nm	4.0 - 4.5Nm	7 - 8Nm	17 - 20Nm	0.7 - 0.8Nm	1.9 - 2.2Nm	1.9 - 2.2Nm

Please visit www.schaffner.com to find more details on filter connectors.

Your local partner: To find your local partner within Schaffner's global network, please go to www.schaffner.com

**Headquarters and
global innovation and
development center**

Schaffner Group
Nordstrasse 11
4542 Luterbach
Switzerland
T +41 32 681 66 26
F +41 32 681 66 30
info@schaffner.ch
www.schaffner.com

Sales and application centers

China
Schaffner EMC Ltd. Shanghai
Building 11, Lane 1365
East Kangqiao Road
Shanghai 201319
T +86 21 6813 9855
F +86 21 6813 9811
cschina@schaffner.com
www.schaffner.com

Germany
Schaffner Deutschland GmbH
Schoemperlenstrasse 12B
76185 Karlsruhe
T +49 721 56910
F +49 721 569110
germanysales@schaffner.com

Finland
Schaffner Oy
Tynninkuja 7
08700 Lohja
T +358 19 35 72 71
F +358 19 32 66 10
finlandsales@schaffner.com

France
Schaffner EMC S.A.S.
112, Quai de Bezons
95103 Argenteuil
T +33 1 34 34 30 60
F +33 1 39 47 02 28
francesales@schaffner.com

Italy
Schaffner EMC S.r.l.
Via Galileo Galilei, 47
20092 Cinisello Balsamo (MI)
T +39 02 66 04 30 45/47
F +39 02 61 23 943
italysales@schaffner.com

Japan
Schaffner EMC K.K.
Mitsui-Seimei Sangenjaya Bldg. 7F
1-32-12, Kamiyama, Setagaya-ku
Tokyo 154-0011
T +81 3 5712 3650
F +81 3 5712 3651
japansales@schaffner.com
www.schaffner.jp

Sweden
Schaffner EMC AB
Turebergstorg 1, 6
19147 Sollentuna
T +46 8 5792 1121/22
F +46 8 92 96 90
swedensales@schaffner.com

Switzerland
Schaffner EMV AG
Nordstrasse 11
4542 Luterbach
T +41 32 681 66 26
F +41 32 681 66 41
sales@schaffner.ch

Singapore
Schaffner EMC Pte Ltd.
Blk 3015A Ubi Road 1
05-09 Kampong Ubi Industrial
Estate
T +65 6377 3283
F +65 6377 3281
singaporesales@schaffner.com

Spain
Schaffner EMC España
Calle Caléndula 93,
Miniparc III, Edificio E
El Soto de la Moraleja,
Alcobendas
28109 Madrid
T +34 618 176 133
spainsales@schaffner.com

Taiwan
Schaffner EMV Ltd.
6th Floor, No 413
Rui Guang Road
Neihu District
Taipei City 114
T +886 2 87525050
F +886 2 87518086
taiwansales@schaffner.com

Thailand
Schaffner EMC Co. Ltd.
Northern Region Industrial Estate
67 Moo 4 Tambon Ban Klang
Amphur Muang P.O. Box 14
Lamphun 51000
T +66 53 58 11 04
F +66 53 58 10 19
thailandsales@schaffner.com

UK
Schaffner Ltd.
5 Ashville Way
Molly Millars Lane
Wokingham
Berkshire RG41 2PL
T +44 118 9770070
F +44 118 9792969
uksales@schaffner.com
www.schaffner.uk.com

USA
Schaffner EMC Inc.
52 Mayfield Avenue
Edison, New Jersey 08837
T +1 732 225 9533
F +1 732 225 4789
usasales@schaffner.com
www.schaffner.com/us

To find your local partner within
Schaffner's global network, please go to

www.schaffner.com

May 2011

© 2011 Schaffner EMC.
Specifications subject to change without
notice. All trademarks recognized.

Schaffner is an ISO-registered company.
Its products are designed and manufac-
tured under the strict quality and environ-
mental requirements of the ISO 9001 and
ISO 14001 standards.

This document has been carefully
checked. However, Schaffner does not
assume any liability for errors or inac-
curacies.

X-ON Electronics

Largest Supplier of Electrical and Electronic Components

Click to view similar products for [Power Line Filters](#) category:

Click to view products by [Schaffner](#) manufacturer:

Other Similar products are found below :

[5B1](#) [6609019-3](#) [6609026-5](#) [6609030-6](#) [6609063-2](#) [6609973-2](#) [7-1609090-5](#) [F1500CA06](#) [F7382Z](#) [F7863Z](#) [FAHAV3100ZC000](#) [806276](#)
[FN2020B-1-06](#) [FN2080B-10-06](#) [FN2090A-1-06](#) [FN2410H-32-33](#) [FN2410H-80-34](#) [FN2412H-16-44](#) [FN406B-0.5-02](#) [FN420-1-13](#) [FP144](#) [8-](#)
[6609089-0](#) [12-MMB-030-11-D](#) [B84144A90R120](#) [20B1](#) [RSEL-2001A](#) [2B1](#) [LP183](#) [1-6609070-1](#) [F1500CA10](#) [1B1](#) [FN2020A-10-06](#)
[FN2020B-3-06](#) [FN2060A-3-06](#) [FN2070A-16-06](#) [FN2070B-16-08](#) [FN2090B-12-06](#) [FN2090Z-1-06](#) [FN2410H-25-33](#) [FN2410H-60-34](#)
[FN2410H-8-44](#) [FN2412H-25-33](#) [FN2412H-8-44](#) [FN610R-3-06](#) [20EHZ7](#) [20K1](#) [30B6](#) [30BCF10R](#) [3K1](#) [4-6609089-0](#)