

NOTES

1. 嵌合相手: 502380-****
MATE WITH: 502380-****
2. 端子テール部 及び ネイルの平坦度: 0.1MAX.
TAIL AND NAIL COPLANARITY TO BE 0.1 MAX.
3. 極数/2=偶数に適用。
APPLY FOR CKT. SIZE / 2 = EVEN.
4. 端子テール部 及び ネイルに錫めっきを使用しているため、
外観に摺動痕が付く場合がございます。
THE WOUND OF FRICTION MIGHT ADHERE TO EXTERNALS
BECAUSE THE TIN PLATING IS USED FOR THA TAIL AND NAIL.
5. 本製品のプラスチック部に黒点等が確認される場合や
色合いが異なる場合がありますが、製品性能に影響はありません。
THERE IS NO INFLUENCE IN THE PRODUCT PERFORMANCE THOUGH
THE BLACK SPOT ETC. MIGHT BE CONFIRMED TO THE PLASTIC PART
OF THIS PRODUCT AND THE SHADE MIGHT BE DIFFERENT.
6. ELV 及び RoHS 適合品
ELV AND ROHS COMPLIANT

| | | | | | |
|-------|-------|-------|-------|-----------------------|--------------------|
| 11.15 | 17.5 | 21 | 22.1 | 502382-15** | 15 |
| 9.9 | 16.25 | 19.75 | 20.85 | 502382-14** | 14 |
| 8.65 | 15 | 18.5 | 19.6 | 502382-13** | 13 |
| 7.4 | 13.75 | 17.25 | 18.35 | 502382-12** | 12 |
| 6.15 | 12.5 | 16 | 17.1 | 502382-11** | 11 |
| 4.9 | 11.25 | 14.75 | 15.85 | 502382-10** | 10 |
| 3.65 | 10 | 13.5 | 14.6 | 502382-09** | 9 |
| 2.4 | 8.75 | 12.25 | 13.35 | 502382-08** | 8 |
| D | C | B | A | EMBOSSED TAPE PACKAGE | 極数 |
| | | | | オーダー番号 | ORDER No. CKT. NO. |

| 番号 NO. | 部品 PART | 材質 MATERIAL |
|-----------|-------------------|---|
| ① | ハウジング HOUSING | 耐熱性樹脂 UL94V-0 色: SHEET 3 参照 HEATPROOF RESIN UL94V-0 COLOR: SEE SHEET 3 |
| ② | ターミナル TERMINAL | 銅合金 COPPER ALLOY 錫めっき: 1.0 micro-meter MIN. TIN (TAIL AREA) ニッケルめっき(下地): 1.0 micro-meter MIN. NICKEL (UNDER PLATING) |
| ③ | ネイル NAIL | 銅合金 COPPER ALLOY 錫めっき: 1.0 micro-meter MIN. TIN ニッケルめっき(下地): 1.0 micro-meter MIN. NICKEL (UNDER PLATING) |

| | | | | | | | | | |
|---|---|--|-------|----------------------------|--------------------|--|------------------------|---------------------------|--|
| REVISED EC NO: J2011-0737 DRWN:TKON CHKD: APPR:NUKITA | DESCRIPTION 2010/11/29 2010/11/29 | GENERAL TOLERANCES (UNLESS SPECIFIED) | | DIMENSION STYLE MM ONLY | | SCALE 5:1 | DESIGN UNITS METRIC | THIRD ANGLE PROJECTION | |
| | | 10 UNDER | ±0.2 | DRAWN BY T. MIYAZAKI | DATE 2006/08/28 | TITLE 1.25 W/B CONN. SINGLE S/T REC. ASS'Y 8-15CKT. | | | |
| | | 10 OVER 30 UNDER | ±0.25 | CHECKED BY K. ASAKAWA | DATE 2006/08/28 | MATERIAL NO. SEE TABLE | | | |
| | | 30 OVER | ±0.3 | APPROVED BY YO. ITO | DATE 2006/08/28 | DOCUMENT NO. SD-502382-002 | | | |
| ANGULAR ±3 ° | | DRAFT WHERE APPLICABLE MUST REMAIN WITHIN DIMENSIONS | | SIZE A3 | | THIS DRAWING CONTAINS INFORMATION THAT IS PROPRIETARY TO MOLEX INCORPORATED AND SHOULD NOT BE USED WITHOUT WRITTEN PERMISSION | | | |

10 9 8 7 6 5 4 3 2 1

F

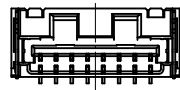

8 CKT.

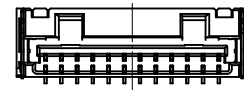

12 CKT.

E

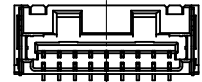

9 CKT.

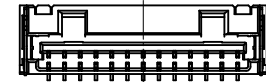

13 CKT.

D

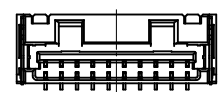

10 CKT.

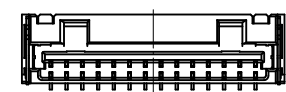

14 CKT.

C

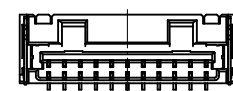

11 CKT.

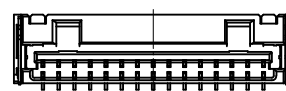

15 CKT.

B

極数の種類
KIND OF CKT. NO. (FRONT VIEW)

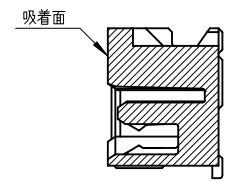
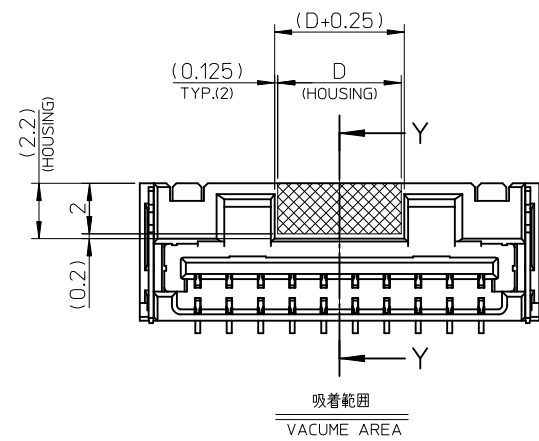

SECTION Y-Y

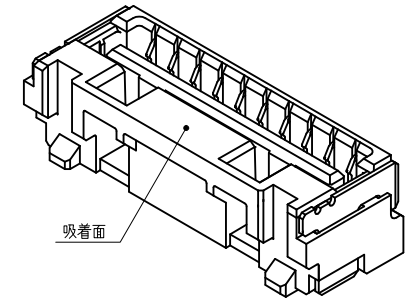
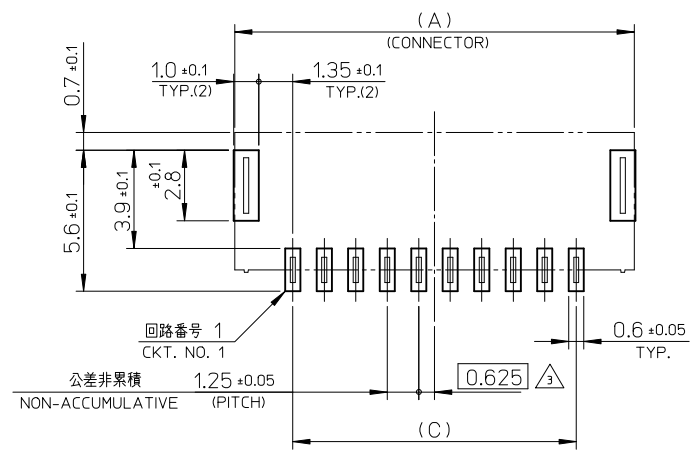

基板パターンレイアウト (参考)
RECOMMENDED P.C.B. PATTERN LAYOUT (REF.)

A

| | | | | | | |
|--|---------------------------------------|---|----------------------------|--------------------|--|-------------------------------|
| REVISED EC NO.: J2011-0737 DRWN:TKGN 2010/11/29 CHKD: APPR:NUKITA 2010/11/29 REV: | GENERAL TOLERANCES (UNLESS SPECIFIED) | | DIMENSION STYLE MM ONLY | SCALE 5:1 | DESIGN UNITS METRIC | THIRD ANGLE PROJECTION |
| | 10 UNDER | ± 0.2 | DRAWN BY T. MIYAZAKI | DATE 2006/08/28 | TITLE 1.25 W/B CONN. SINGLE S/T REC. ASS'Y 8-15CKT. | |
| | 10 OVER 30 UNDER | ± 0.25 | CHECKED BY K. ASAKAWA | DATE 2006/08/28 | MOLEX INCORPORATED | |
| | 30 OVER | ± 0.3 | APPROVED BY YO. ITO | DATE 2006/08/28 | MATERIAL NO. SEE TABLE | DOCUMENT NO. SD-502382-002 |
| | ANGULAR ±3 ° | | SIZE A3 | | SHEET NO. 2 OF 3 | |
| DRAFT WHERE APPLICABLE MUST REMAIN WITHIN DIMENSIONS | | THIS DRAWING CONTAINS INFORMATION THAT IS PROPRIETARY TO MOLEX INCORPORATED AND SHOULD NOT BE USED WITHOUT WRITTEN PERMISSION | | | | |

WITH CAPTON TAPE

| HSG COLOR : GREEN | | HSG COLOR : BLUE | | HSG COLOR : YELLOW | | HSG COLOR : RED | | HSG COLOR : BLACK | | HSG COLOR : NATURAL | | | |
|---|------------------------------|---|------------------------------|---|------------------------------|---|------------------------------|---|------------------------------|---|------------------------------|-----------------|---|
| 502382-1536 | 502382-**16 | 502382-1534 | 502382-**14 | ≡ | 502382-**13 | 502382-1532 | 502382-**12 | 502382-1531 | 502382-**11 | 502382-1572 | 502382-**08 | 15 | |
| 502382-1436 | | 502382-1434 | | ≡ | | 502382-1432 | | 502382-1431 | | 502382-1472 | | 14 | |
| 502382-1336 | | 502382-1334 | | ≡ | | 502382-1332 | | 502382-1331 | | 502382-1372 | | 13 | |
| 502382-1236 | | 502382-1234 | | ≡ | | 502382-1232 | | 502382-1231 | | 502382-1272 | | 12 | |
| 502382-1136 | | 502382-1134 | | ≡ | | 502382-1132 | | 502382-1131 | | 502382-1172 | | 11 | |
| 502382-1036 | | 502382-1034 | | ≡ | | 502382-1032 | | 502382-1031 | | 502382-1072 | | 10 | |
| 502382-0936 | | 502382-0934 | | 502382-0933 | | ≡ | | 502382-0932 | | 502382-0931 | | 502382-0972 | 9 |
| 502382-0836 | | 502382-0834 | | ≡ | | 502382-0832 | | 502382-0831 | | 502382-0872 | | 8 | |
| EMBOSSSED TAPE PACKAGE オーダー番号ORDER No. | コネクタシリーズ CONNECTOR SERIES | EMBOSSSED TAPE PACKAGE オーダー番号ORDER No. | コネクタシリーズ CONNECTOR SERIES | EMBOSSSED TAPE PACKAGE オーダー番号ORDER No. | コネクタシリーズ CONNECTOR SERIES | EMBOSSSED TAPE PACKAGE オーダー番号ORDER No. | コネクタシリーズ CONNECTOR SERIES | EMBOSSSED TAPE PACKAGE オーダー番号ORDER No. | コネクタシリーズ CONNECTOR SERIES | EMBOSSSED TAPE PACKAGE オーダー番号ORDER No. | コネクタシリーズ CONNECTOR SERIES | 極数 (KT. NO.) | |

| WITH CAPTON TAPE | | |
|---|------------------------------|-----------------|
| HSG COLOR : ORANGE | | |
| ≡ | 502382-**18 | 15 |
| ≡ | | 14 |
| ≡ | | 13 |
| ≡ | | 12 |
| ≡ | | 11 |
| ≡ | | 10 |
| 502382-0938 | | 9 |
| ≡ | | 8 |
| EMBOSSSED TAPE PACKAGE オーダー番号ORDER No. | コネクタシリーズ CONNECTOR SERIES | 極数 (KT. NO.) |

| WITHOUT CAPTON TAPE | | |
|---|------------------------------|-----------------|
| HSG COLOR : NATURAL | | |
| 502382-1570 | 502382-**09 | 15 |
| 502382-1470 | | 14 |
| 502382-1370 | | 13 |
| 502382-1270 | | 12 |
| 502382-1170 | | 11 |
| 502382-1070 | | 10 |
| 502382-0970 | | 9 |
| 502382-0870 | | 8 |
| EMBOSSSED TAPE PACKAGE オーダー番号ORDER No. | コネクタシリーズ CONNECTOR SERIES | 極数 (KT. NO.) |

| | | | | | | | | |
|--|--|-------|-----------------------------------|--------------------|---|-------------------------------|------------------------|--|
| REVISED EC NO: J2011-0737 DRWN:TKGN 2010/11/29 CHKD: APPR:NUKITA 2010/11/29 | GENERAL TOLERANCES (UNLESS SPECIFIED) | | DIMENSION STYLE MM ONLY | | SCALE ---- | DESIGN UNITS METRIC | THIRD ANGLE PROJECTION | |
| | 10 UNDER | ±0.2 | DRAWN BY T.MIYAZAKI | DATE 2006/08/28 | TITLE 1.25 W/B CONN. SINGLE S/T REC. ASS'Y 8-15CKT. | | | |
| | 10 OVER 30 UNDER | ±0.25 | CHECKED BY K.ASAKAWA | DATE 2006/08/28 | MATERIAL NO. SEE TABLE | | | |
| | 30 OVER | ±0.3 | APPROVED BY YO.IITO | DATE 2006/08/28 | DOCUMENT NO. SD-502382-002 | | | |
| | ANGULAR ±3 ° DRAFT WHERE APPLICABLE MUST REMAIN WITHIN DIMENSIONS | | SIZE A3 | | SHEET NO. 3 OF 3 | | | |

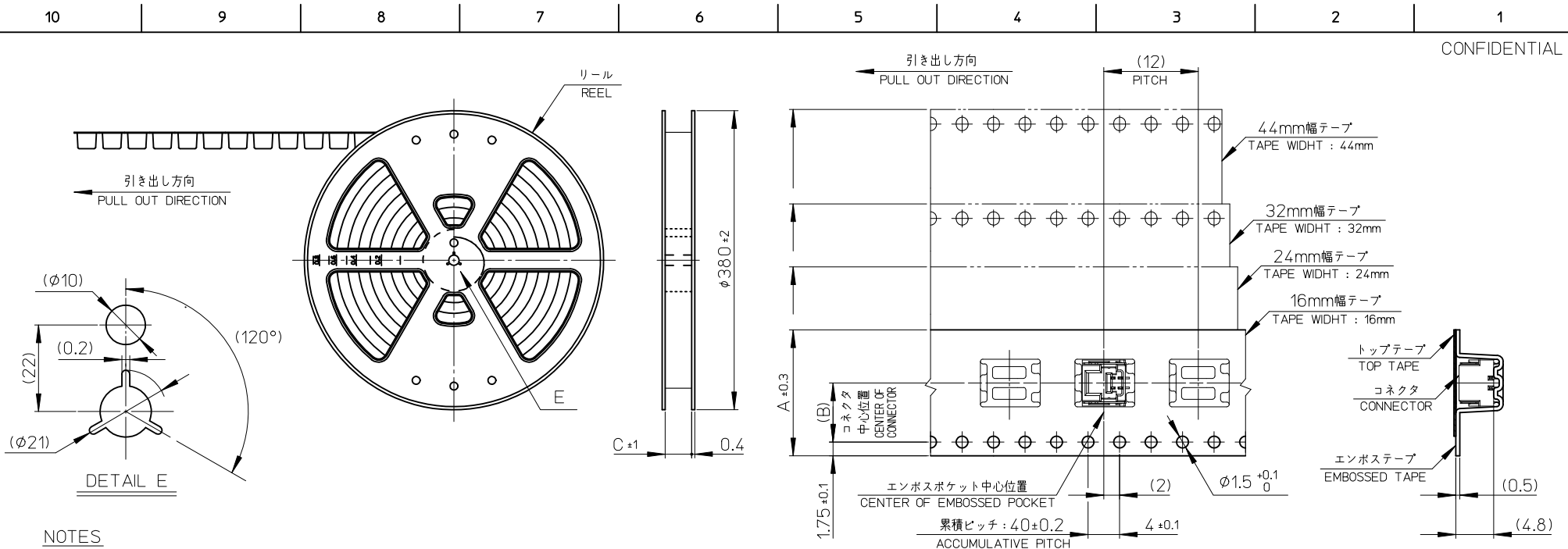

NOTES

- 製品詳細寸法については、SD-502382-001, -002 を参照下さい。
PLEASE REFER TO SD-502382-001, -002 FOR THE DETAILED DIMENSION OF THE CONNECTOR.
- 梱包数量 : 1400個
NUMBER OF CONNECTIONS : 1400 PIECES/REEL.
- リードテープ長さ
LEAD TAPE LENGTH

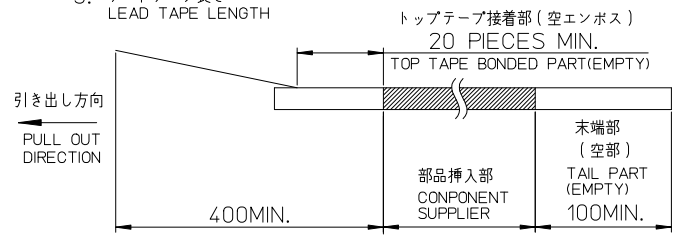

- 材料
MATERIAL
キャリアテープ : ポリスチレン
CARRIER TAPE : POLYSTYRENE
トップテープ : ポリエステル、ポリエチレン、ポリエチレンテレフタレート
TOP TAPE : POLYESTER, POLYETHYLENE, POLYETHYLENE TEREPHTHALATE
リール : ポリスチレン <リサイクル材を含む>
REEL : POLYSTYRENE <RECYCLE MATERIAL CONTAINED>
- ELV 及び RoHS 適合品
ELV AND RoHS COMPLIANT

| | | | | |
|------|------|-----------------------------|----------------------|----------------|
| 45.5 | 20.2 | 44 | 502382-15** | 15 |
| 45.5 | 20.2 | 44 | 502382-14** | 14 |
| 33.5 | 14.2 | 32 | 502382-13** | 13 |
| 33.5 | 14.2 | 32 | 502382-12** | 12 |
| 33.5 | 14.2 | 32 | 502382-11** | 11 |
| 33.5 | 14.2 | 32 | 502382-10** | 10 |
| 25.5 | 11.5 | 24 | 502382-09** | 9 |
| 25.5 | 11.5 | 24 | 502382-08** | 8 |
| 25.5 | 11.5 | 24 | 502382-07** | 7 |
| 25.5 | 11.5 | 24 | 502382-06** | 6 |
| 25.5 | 11.5 | 24 | 502382-05** | 5 |
| 25.5 | 11.5 | 24 | 502382-04** | 4 |
| 17.5 | 7.5 | 16 | 502382-03** | 3 |
| 17.5 | 7.5 | 16 | 502382-02** | 2 |
| C | B | エンボステープ幅 A WIDTH OF TAPE | 製品番号 MATERIAL NO. | 極数 EXT. NO. |

| | | | | | | | | | |
|--|---------------------------------------|---|----------------------------|--------------------|---|------------------------|--|------------------------|--|
| REVISED EC NO: J2011-0737 DRWN:TKGN 2010/11/29 CHKD: APPR:NUKITA 2010/11/29 REV | GENERAL TOLERANCES (UNLESS SPECIFIED) | | DIMENSION STYLE MM ONLY | | SCALE --- | DESIGN UNITS METRIC | | THIRD ANGLE PROJECTION | |
| | 10 UNDER | ±0.2 | DRAWN BY T. MIYAZAKI | DATE 2006/10/16 | TITLE 1.25 W/B CONN. SINGLE S/T REC. EMBTP PKG | | | | |
| | 10 OVER 30 UNDER | ±0.25 | CHECKED BY K. ASAKAWA | DATE 2006/10/16 | MOLEX INCORPORATED SD-502382-003 SHEET NO. 1 OF 2 | | | | |
| | 30 OVER | ±0.3 | APPROVED BY YO. ITO | DATE 2006/10/16 | | | | | |
| ANGULAR ±3 ° | | MATERIAL NO. SEE TABLE | | DOCUMENT NO. | | | | | |
| DRAFT WHERE APPLICABLE MUST REMAIN WITHIN DIMENSIONS | | THIS DRAWING CONTAINS INFORMATION THAT IS PROPRIETARY TO MOLEX INCORPORATED AND SHOULD NOT BE USED WITHOUT WRITTEN PERMISSION | | | | | | | |

X-ON Electronics

Largest Supplier of Electrical and Electronic Components

Click to view similar products for [Headers & Wire Housings](#) category:

Click to view products by [Molex](#) manufacturer:

Other Similar products are found below :

[95000-104TRLF](#) [10135584-644402LF](#) [DF62W-EP2022PCA](#) [95000-106TRLF](#) [DF62W-2022SCA](#) [DF62W-EP2022PC](#) [2203348](#) [DF62W-2022SC](#) [1084018](#) [1029039](#) [1084017](#) [802-10-012-10-002000](#) [1112640](#) [1112639](#) [000-34000](#) [0009482033](#) [0009507031](#) [57102-S06-03LF](#) [57202-S52-04LF](#) [PCN6-15S-2.5E](#) [0039019024](#) [58102-G61-06LF](#) [582553-1](#) [0009485154](#) [0009508121](#) [0022285053](#) [0050291907](#) [018731A](#) [LY20-4P-DT1-P1E-BR](#) [02.125.8002.8](#) [60101931](#) [60598-1 \(Cut Strip\)](#) [M1625-3R/100](#) [61062-3](#) [61082-181009](#) [636-1427](#) [638009-1](#) [641938-9](#) [641991-4](#) [644168-1](#) [647662-1](#) [65039-019ELF](#) [65817-002LF](#) [65817-015LF](#) [65863-015LF](#) [66207-023LF](#) [67016-026LF](#) [67046-001LF](#) [67095-007LF](#) [67230-005LF](#)