

Dialight

Micro LED® SMD LED "598 SERIES" 1208 PACKAGE (3.2mm X 1.5mm X 1.0mm) Single Color Right Angle

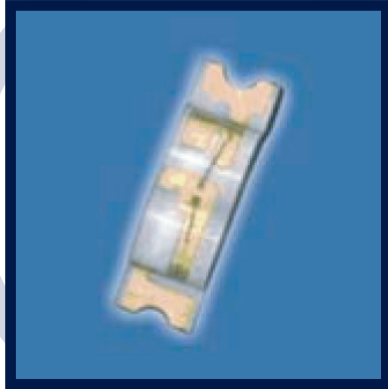

FEATURES / BENEFITS

- ▲ Compatible with automatic placement equipment
- ▲ RoHS compliant
- ▲ Packaged in 8mm tape, 7" reel and 20 per strip
- ▲ Meets EIA-481-1 pkg. std.

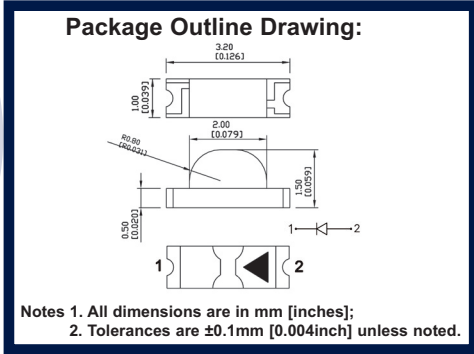

ORDERING INFORMATION

5 9 8 - 8 3 1 0 - 1 0 7 F
 Packaging Option

2	20 pieces on tape
7	7" reel 3000pcs / reel

PART NUMBERS

DIALIGHT P/N	EMITTED COLOR	MATERIAL	LENS COLOR	LUMINOUS INTENSITY			DOMINANT WAVELENGTH			FORWARD VOLTAGE			VIEWING ANGLE
				If = 20 ma			If = 20 ma			If = 20 ma			° DEGREES
				MIN	TYP	MAX	MIN	TYP	MAX	MIN	TYP	MAX	
598-8310-107F	RED	AllnGaP	Water Clear	-	-	70	630	635	640	1.8	2	2.4	160
598-8320-107F	RED-ORANGE	AllnGaP	Water Clear	80	120	150	620	625	630	1.8	2	2.4	160
598-8330-107F	ORANGE	AllnGaP	Water Clear	90	110	150	600	-	610	1.8	2	2.4	160
598-8340-107F	YELLOW	AllnGaP	Water Clear	100	130	160	590	-	595	1.8	2	2.4	160
598-8350-107F	YELLOW	AllnGaP	Water Clear	100	130	160	583	-	590	1.8	2	2.4	160
598-8360-107F	YELLOW-GREEN	AllnGaP	Water Clear	30	50	60	570	-	575	1.8	2	2.4	160
598-8370-107F	GREEN	GaP	Water Clear	18	28	50	562	-	570	1.8	2	2.4	160
598-8380-107F	GREEN	InGaP	Water Clear	150	220	300	520	523	525	3	3.2	3.5	160
598-8391-107F	BLUE	InGaP	Water Clear	90	140	160	470	473	475	2.8	3.2	3.5	160

ABSOLUTE RATINGS (@ Ta = 25°C)

DIALIGHT P/N	Power Dissipation	Forward Current	Reverse Voltage	Operating Temperature Range	Storage Temperature Range	Peak Pulse Forward Current	Electrostatic Discharge
	(mW)	(mA)	(V)	(°C)	(°C)	(mA)	(HBM)
598-8310-107F	60	25	5	-40~+100	-40~+100	100	2000
598-8320-107F	60	25	5	-40~+100	-40~+100	100	2000
598-8330-107F	60	25	5	-40~+100	-40~+100	100	2000
598-8340-107F	55	25	5	-40~+100	-40~+100	100	2000
598-8350-107F	55	25	5	-40~+100	-40~+100	100	2000
598-8360-107F	60	25	5	-40~+100	-40~+100	100	2000
598-8370-107F	60	25	5	-40~+100	-40~+100	100	2000
598-8380-107F	87.5	25	5	-40~+100	-40~+100	100	1000
598-8391-107F	87.5	25	5	-40~+100	-40~+100	100	1000



Dialight Corporation
1501 Route 34 South • Farmingdale, NJ 07727 USA
Tel: (1) 732-919-3119 • Fax: (1) 732-751-5778 • www.dialight.com



MDEI5981208RT_A

MECHANICAL DIMENSIONS

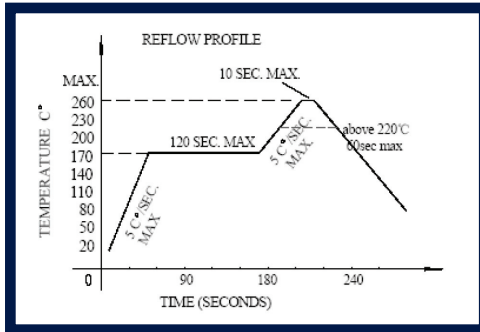
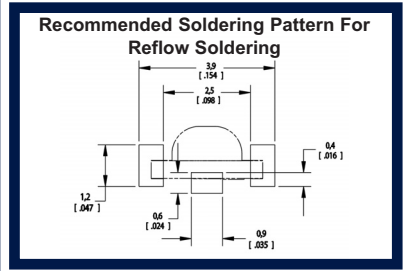
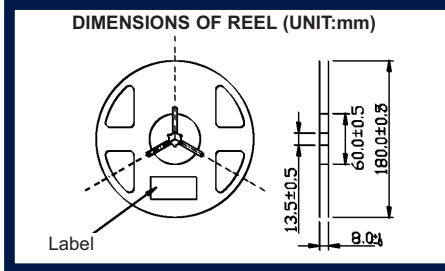
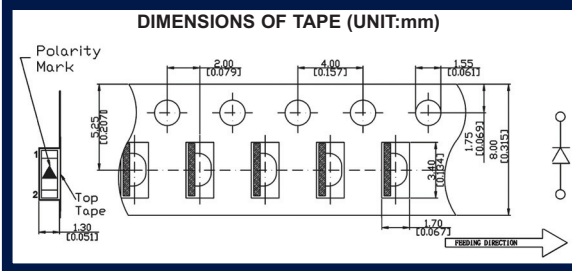

	REFLOW SOLDERING	HAND SOLDERING
Pre-heat	160~180°C	Temperature
Pre-heat time	120 seconds Max.	300°C Max.
Peak temperature	260°C Max.	Soldering time
Soldering time	10 seconds Max.	3 second Max (one time only)
Condition	Refer to temperature -profile	

OPTICAL AND ELECTRICAL CHARACTERISTICS CURVES

RED 630-642NM, RED-ORANGE 620-630NM, ORANGE 600-610NM, YELLOW 590-595NM, YELLOW 583-590NM, YELLOW GREEN 570-575NM, GREEN 562-570NM

FORWARD VOLTAGE VS FORWARD CURRENT (Ta=25°C)

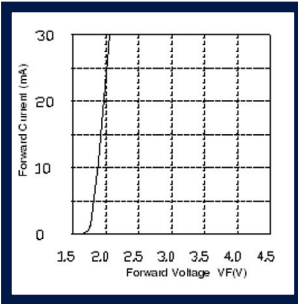

RELATIVE INTENSITY VS FORWARD CURRENT (Ta=25°C)

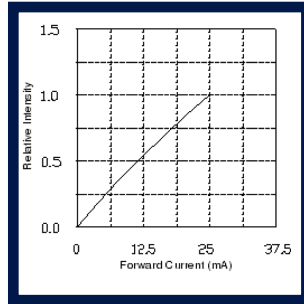

DERATING

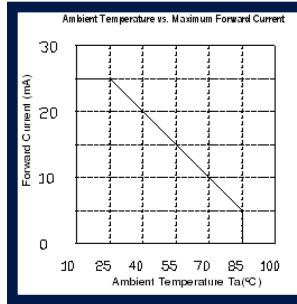

RELATIVE INTENSITY VS AMBIENT TEMPERATURE

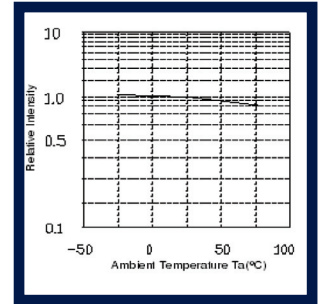

GREEN 520-525NM, BLUE 470-475NM

FORWARD VOLTAGE VS FORWARD CURRENT (Ta=25°C)

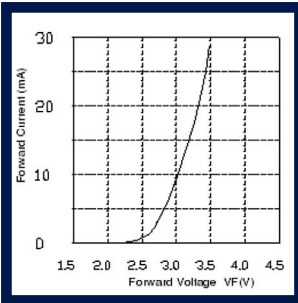

RELATIVE INTENSITY VS FORWARD CURRENT (Ta=25°C)

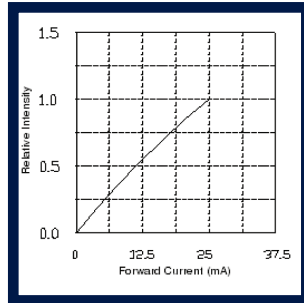

DERATING

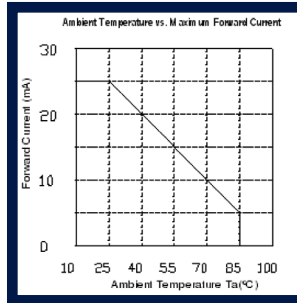

RELATIVE INTENSITY VS AMBIENT TEMPERATURE

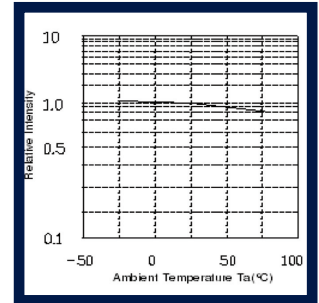

Dialight Corporation

1501 Route 34 South • Farmingdale, NJ 07727 USA

Tel: (1) 732-919-3119 • Fax: (1) 732-751-5778 • www.dialight.com



MDEI5981208RT_A

X-ON Electronics

Largest Supplier of Electrical and Electronic Components

Click to view similar products for [Standard LEDs - Through Hole category](#):

Click to view products by [Dialight manufacturer](#):

Other Similar products are found below :

[LTL-10254W](#) [LTL-1214A](#) [LTL-1BEDJ](#) [LTL-2231AT](#) [LTL-3251A](#) [LTL-4262N](#) [LTL-5234](#) [LTL87HTBK](#) [LTL-87HD4B](#) [7383/V7C3-BSTA-L/PR3/MS](#) [HLMP-AG64-X10ZZ](#) [HLMP-EG1A-Z10DV](#) [HLMP-EL3B-WXKDD](#) [HLMP-HB74-UVBDD](#) [HLMP-HG65-VY0DD](#) [HLMP-HM74-34CDD](#) [HLMP-HM75-34CDD](#) [1L0532V23G0TD001](#) [NSPW500CS](#) [C4SMA-BGF-CQ34Q3C2](#) [L53GC13](#) [264-7SURTS530-A3](#) [L-C150JRCT](#) [S4SMS-BJF-CQ42QGF2](#) [S4SMS-GJF-CW12QMF2](#) [LD CQDP-1U3U-W5-1-K](#) [LO566UHR3-70G-A3](#) [SLA560WBD2PT3](#) [LP379PPG1C0G0300001](#) [SLR-322MCT32](#) [SLR-342DUT32](#) [SLR-342MC3F](#) [SLR343BC7TT32](#) [SLR343BCTT32](#) [SLX-LX3044GD](#) [SLX-LX3044ID](#) [SLX-LX3044YD](#) [1.90690.3330000](#) [SSL-LX20483ID](#) [SSL-LX3034YD](#) [SSL-LX5093LGT-11](#) [SSL-LX5093PGC](#) [SSL-LX5093SRC/F](#) [SSL-LX5093SYT](#) [SSL-LX509E3SIT](#) [SSL-LX509FT3ID](#) [SSL-LX50FT3GD](#) [SSS-LX4673ID-410B](#) [1L0532Y24I0TD001](#) [264-7SYGD/S530-E2](#)