



5/2

Introduction

3RV Motor Starter Protectors up to 100 A

- 5/4 General data
- 5/5 For motor protection
- 5/8 For motor protection with overload relay function
- 5/9 For starter combinations
- 5/10 For transformer protection
- 5/11 For fuse monitoring
- 5/12 For plant protection according to UL 489 / CSA C22.2 No.5-02
- 5/13 For distance protection
- Accessories
- 5/14 Mountable accessories
- 5/19 Busbar accessories
- 5/22 Rotary operating mechanisms
- 5/24 Mounting accessories
- 5/28 Enclosures and front plates

Overload Relays

- 5/31 General data
- 3RB2 Solid-State Overload Relays
- 5/35 3RB20, 3RB21 for standard applications
- 5/44 3RB22, 3RB23 for high-feature applications
- 5/49 Accessories
- 3RU1 Thermal Overload Relays
- 5/51 3RU11 for standard applications
- 5/55 Accessories



Protection Equipment

Introduction

Overview

Type	3RV10	3RV11	3RV13	3RV14	3RV16	3RV16	3RV17
------	-------	-------	-------	-------	-------	-------	-------

- 1) For symmetrical loading of the three phases.
- 2) With molded-plastic enclosure 500 V AC.
- 3) For overload protection of the motors, appropriate overload relays must be used.
- 4) Only for motor starter protectors with Cage Clamp terminals.
- 5) Only lateral auxiliary switches

3RV Motor Starter Protectors up to 100 A

Introduction



Type		3RU11	3RB20	3RB21	3RB22/3RB23																		
Overload relays up to 630 A																							
Applications																							
Plant protection		✓ ¹⁾	✓ ¹⁾	✓ ¹⁾	✓ ¹⁾																		
Motor protection		✓	✓	✓	✓																		
Alternating current, 3-phase		✓	✓	✓	✓																		
Alternating current, 1-phase		✓	–	–	✓																		
Direct current		✓	–	–	–																		
Size of contactor		S00, S0, S2, S3	S00 ... S12	S00 ... S12	S00 ... S12																		
Rated operational current I_e																							
Size S00	A	up to 12	up to 12	up to 12	} up to 25																		
Size S0	A	up to 25	up to 25	up to 25																			
Size S2	A	up to 50	up to 50	up to 50	} up to 100																		
Size S3	A	up to 100	up to 100	up to 100																			
Size S6	A	–	up to 200	up to 200	up to 200																		
Size S10/S12, size 14 (3TF6)	A	–	up to 630	up to 630	up to 630																		
Rated operational voltage U_e	V	690 / 1000 AC ²⁾	690 / 1000 AC ²⁾	690 / 1000 AC ²⁾	690 / 1000 AC ³⁾																		
Rated frequency	Hz	50/60	50/60	50/60	50/60																		
Trip class		CLASS 10	CLASS 10, CLASS 20	CLASS 5, 10, 20, 30 adjustable	CLASS 5, 10, 20, 30 adjustable																		
Thermal overload release	A	0.11 ... 0.16	–	–	–																		
	A	up to 80 ... 100	–	–	–																		
Solid-state overload release	A	–	0.1 ... 0.4	0.1 ... 0.4	0.3 ... 3																		
	A	–	up to 160 ... 630	up to 160 ... 630	up to 63 ... 630																		
Rating for induction motor at 400 V AC	kW	0.04	0.04 ... 0.09	0.04 ... 0.09	0.09 ... 1.1																		
	kW	up to 45	up to 90 ... 450	up to 90 ... 450	up to 37 ... 450																		
Accessories																							
For sizes		S00	S0	S2	S3	S00	S0	S2	S3	S6	S10/S12	S00	S0	S2	S3	S6	S10/S12	S00	S0	S2	S3	S6	S10/S12
Terminal brackets for stand-alone installation		✓	✓	✓	✓	✓	✓	4)	4)	4)	4)	✓	✓	4)	4)	4)	4)	4)	4)	4)	4)	4)	4)
Mechanical RESET		✓	✓	✓	✓	✓	✓	✓	✓	✓	✓	✓	✓	✓	✓	✓	✓	–	–	–	–	–	–
Cable release for RESET		✓	✓	✓	✓	✓	✓	✓	✓	✓	✓	✓	✓	✓	✓	✓	✓	–	–	–	–	–	–
Electrical remote RESET		✓	✓	✓	✓	–	–	–	–	–	–	Integrated in the unit					Integrated in the unit						
Terminal covers		–	–	✓	✓	–	–	–	✓	✓	✓	–	–	–	✓	✓	✓	–	–	–	✓	✓	✓
Sealable covers for setting knobs		Integrated in the unit			✓	✓	✓	✓	✓	✓	✓	✓	✓	✓	✓	✓	✓	✓	✓	✓	✓	✓	✓

1) The units are responsible in the main circuit for overload protection of the assigned electrical loads (e.g. motors), feeder cable and other switching and protection devices in the respective load feeder.

2) Size S3 and larger up to 1000 V AC.

3) Sizes S6 and S10/12 up to 1000 V AC.

4) Stand-alone installation without accessories is possible.

3RV Motor Starter Protectors up to 100 A

General data

Overview



S0 motor starter protectors

3RV1 motor starter protectors are compact, current limiting motor starter protectors which are optimized for load feeders. The motor starter protectors are used for switching and protecting three-phase induction motors of up to 45 kW at 400 V AC and for other loads with rated currents of up to 100 A.

Type of construction

The motor starter protectors are available in four sizes:

- Size S00 – overall width 45 mm, max. rated current 12 A, at 400 V AC suitable for 3-phase induction motors up to 5.5 kW.
- Size S0 – overall width 45 mm, max. rated current 25 A, at 400 V AC suitable for 3-phase induction motors up to 11 kW.
- Size S2 – overall width 55 mm, max. rated current 50 A, at 400 V AC suitable for 3-phase induction motors up to 22 kW.
- Size S3 – overall width 70 mm, max. rated current 100 A, at 400 V AC suitable for 3-phase induction motors up to 45 kW.

Application

Operating conditions

3RV1 motor starter protectors are suitable for use in any climate. They are intended for use in enclosed rooms in which no severe conditions (such as dust, caustic vapors, hazardous gases) prevail. When installed in dusty and damp areas, suitable enclosures must be provided.

3RV motor starter protectors can optionally be fed from the top or from below.

The permissible ambient temperatures, the maximum switching capacities, the tripping currents and other boundary conditions can be found in the technical specifications and tripping characteristics.

3RV1 motor starter protectors are suitable for use in IT systems (IT networks). In this case, the different short-circuit breaking capacity in the IT system must be taken into account.

Since operational currents, starting currents and current peaks are different even for motors with identical power ratings due to the inrush current, the motor ratings in the selection tables are only guide values. The specific rated and start-up data of the motor to be protected is always paramount to the choice of the most suitable motor starter protector. This also applies to motor starter protectors for transformer protection.

Possible uses

The 3RV1 motor starter protectors can be used:

- For short-circuit protection
- For motor protection (also with overload relay function)
- For plant protection
- For short-circuit protection for starter combinations
- For transformer protection
- As main control and EMERGENCY-STOP switches
- For fuse monitoring
- For use in IT systems (IT networks)
- For switching of DC currents
- As voltage transformer circuit-breakers

More information is available under "Configuration".

3RV Motor Starter Protectors up to 100 A

For motor protection

Selection and ordering data

Class 10, without/with auxiliary switches

	Rated current	Suitable for three-phase induction motors ¹⁾ with P	Setting range for thermal overload release	Instantaneous overcurrent release	Short-circuit breaking capacity at 400 V AC	DT	Screw connection	PU (UNIT, SET, M)	PS*	PG	Weight per PU approx. ²⁾
	I_n	kW	A	A	A	kA		Order No.	Price per PU		

Size S00



0.16	0.04	0.11 ... 0.16	2.1	100	3RV10 11-0AA1 □	1	1 unit	101	0.245
0.2	0.06	0.14 ... 0.2	2.6	100	3RV10 11-0BA1 □	1	1 unit	101	0.246
0.25	0.06	0.18 ... 0.25	3.3	100	3RV10 11-0CA1 □	1	1 unit	101	0.246
0.32	0.09	0.22 ... 0.32	4.2	100	3RV10 11-0DA1 □	1	1 unit	101	0.247
0.4	0.09	0.28 ... 0.4	5.2	100	3RV10 11-0EA1 □	1	1 unit	101	0.250
0.5	0.12	0.35 ... 0.5	6.5	100	3RV10 11-0FA1 □	1	1 unit	101	0.247
0.63	0.18	0.45 ... 0.63	8.2	100	3RV10 11-0GA1 □	1	1 unit	101	0.249
0.8	0.18	0.55 ... 0.8	10	100	3RV10 11-0HA1 □	1	1 unit	101	0.250
1	0.25	0.7 ... 1	13	100	3RV10 11-0JA1 □	1	1 unit	101	0.249
1.25	0.37	0.9 ... 1.25	16	100	3RV10 11-0KA1 □	1	1 unit	101	0.297
1.6	0.55	1.1 ... 1.6	21	100	3RV10 11-1AA1 □	1	1 unit	101	0.298
2	0.75	1.4 ... 2	26	100	3RV10 11-1BA1 □	1	1 unit	101	0.297
2.5	0.75	1.8 ... 2.5	33	100	3RV10 11-1CA1 □	1	1 unit	101	0.298
3.2	1.1	2.2 ... 3.2	42	100	3RV10 11-1DA1 □	1	1 unit	101	0.299
4	1.5	2.8 ... 4	52	100	3RV10 11-1EA1 □	1	1 unit	101	0.296
5	1.5	3.5 ... 5	65	100	3RV10 11-1FA1 □	1	1 unit	101	0.301
6.3	2.2	4.5 ... 6.3	82	100	3RV10 11-1GA1 □	1	1 unit	101	0.303
8	3	5.5 ... 8	104	50	3RV10 11-1HA1 □	1	1 unit	101	0.304
10	4	7 ... 10	130	50	3RV10 11-1JA1 □	1	1 unit	101	0.300
12	5.5	9 ... 12	156	50	3RV10 11-1KA1 □	1	1 unit	101	0.297

Size S0



0.16	0.04	0.11 ... 0.16	2.1	100	3RV10 21-0AA1 □	1	1 unit	101	0.300
0.2	0.06	0.14 ... 0.2	2.6	100	3RV10 21-0BA1 □	1	1 unit	101	0.304
0.25	0.06	0.18 ... 0.25	3.3	100	3RV10 21-0CA1 □	1	1 unit	101	0.302
0.32	0.09	0.22 ... 0.32	4.2	100	3RV10 21-0DA1 □	1	1 unit	101	0.303
0.4	0.09	0.28 ... 0.4	5.2	100	3RV10 21-0EA1 □	1	1 unit	101	0.303
0.5	0.12	0.35 ... 0.5	6.5	100	3RV10 21-0FA1 □	1	1 unit	101	0.304
0.63	0.18	0.45 ... 0.63	8.2	100	3RV10 21-0GA1 □	1	1 unit	101	0.305
0.8	0.18	0.55 ... 0.8	10	100	3RV10 21-0HA1 □	1	1 unit	101	0.370
1	0.25	0.7 ... 1	13	100	3RV10 21-0JA1 □	1	1 unit	101	0.368
1.25	0.37	0.9 ... 1.25	16	100	3RV10 21-0KA1 □	1	1 unit	101	0.369
1.6	0.55	1.1 ... 1.6	21	100	3RV10 21-1AA1 □	1	1 unit	101	0.371
2	0.75	1.4 ... 2	26	100	3RV10 21-1BA1 □	1	1 unit	101	0.371
2.5	0.75	1.8 ... 2.5	33	100	3RV10 21-1CA1 □	1	1 unit	101	0.372
3.2	1.1	2.2 ... 3.2	42	100	3RV10 21-1DA1 □	1	1 unit	101	0.375
4	1.5	2.8 ... 4	52	100	3RV10 21-1EA1 □	1	1 unit	101	0.370
5	1.5	3.5 ... 5	65	100	3RV10 21-1FA1 □	1	1 unit	101	0.376
6.3	2.2	4.5 ... 6.3	82	100	3RV10 21-1GA1 □	1	1 unit	101	0.374
8	3	5.5 ... 8	104	100	3RV10 21-1HA1 □	1	1 unit	101	0.374
10	4	7 ... 10	130	100	3RV10 21-1JA1 □	1	1 unit	101	0.375
12.5	5.5	9 ... 12.5	163	100	3RV10 21-1KA1 □	1	1 unit	101	0.374
16	7.5	11 ... 16	208	50	3RV10 21-4AA1 □	1	1 unit	101	0.382
20	7.5	14 ... 20	260	50	3RV10 21-4BA1 □	1	1 unit	101	0.376
22	11	17 ... 22	286	50	3RV10 21-4CA1 □	1	1 unit	101	0.378
25	11	20 ... 25	325	50	3RV10 21-4DA1 □	1	1 unit	101	0.382

Order No. supplement for transverse auxiliary switches

None
1 NO + 1 NC

Additional price³⁾

0 None
5 X

- Standard value for 4-pole standard motors at 50 Hz 400 V AC. The actual starting and rated data of the motor to be protected must be considered when selecting the units.
- Weights are specified for variants with auxiliary switch.
- Totals are rounded up and down. This may lead to slight differences in the overall price.

Auxiliary switches can also be ordered separately (see "Mountable Accessories").

Multi-unit/reusable packaging, see "Appendix" --> "Ordering Notes".

* You can order this quantity or a multiple thereof.

3RV Motor Starter Protectors up to 100 A

For motor protection

Class 10, without/with auxiliary switches

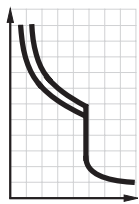

Rated current	Suitable for three-phase induction motors ¹⁾ with P	Setting range for thermal overload release	Instantaneous overcurrent release	Short-circuit breaking capacity at 400 V AC	DT	Cage Clamp connection	PU (UNIT, SET, M)	PS*	PG	Weight per PU approx. ²⁾
I_n				I_{cu}		Order No.	Price per PU			
A	kW	A	A	kA						kg

Size S00



0.16	0.04	0.11 ... 0.16	2.1	100		3RV10 11-0AA2 □	1	1 unit	101	0.245
0.2	0.06	0.14 ... 0.2	2.6	100		3RV10 11-0BA2 □	1	1 unit	101	0.245
0.25	0.06	0.18 ... 0.25	3.3	100		3RV10 11-0CA2 □	1	1 unit	101	0.246
0.32	0.09	0.22 ... 0.32	4.2	100		3RV10 11-0DA2 □	1	1 unit	101	0.246
0.4	0.09	0.28 ... 0.4	5.2	100		3RV10 11-0EA2 □	1	1 unit	101	0.250
0.5	0.12	0.35 ... 0.5	6.5	100		3RV10 11-0FA2 □	1	1 unit	101	0.247
0.63	0.18	0.45 ... 0.63	8.2	100		3RV10 11-0GA2 □	1	1 unit	101	0.252
0.8	0.18	0.55 ... 0.8	10	100		3RV10 11-0HA2 □	1	1 unit	101	0.250
1	0.25	0.7 ... 1	13	100		3RV10 11-0JA2 □	1	1 unit	101	0.249
1.25	0.37	0.9 ... 1.25	16	100		3RV10 11-0KA2 □	1	1 unit	101	0.297
1.6	0.55	1.1 ... 1.6	21	100		3RV10 11-1AA2 □	1	1 unit	101	0.298
2	0.75	1.4 ... 2	26	100		3RV10 11-1BA2 □	1	1 unit	101	0.297
2.5	0.75	1.8 ... 2.5	33	100		3RV10 11-1CA2 □	1	1 unit	101	0.298
3.2	1.1	2.2 ... 3.2	42	100		3RV10 11-1DA2 □	1	1 unit	101	0.300
4	1.5	2.8 ... 4	52	100		3RV10 11-1EA2 □	1	1 unit	101	0.298
5	1.5	3.5 ... 5	65	100		3RV10 11-1FA2 □	1	1 unit	101	0.303
6.3	2.2	4.5 ... 6.3	82	100		3RV10 11-1GA2 □	1	1 unit	101	0.303
8	3	5.5 ... 8	104	50		3RV10 11-1HA2 □	1	1 unit	101	0.304
10	4	7 ... 10	130	50		3RV10 11-1JA2 □	1	1 unit	101	0.300
12	5.5	9 ... 12	156	50		3RV10 11-1KA2 □	1	1 unit	101	0.298

Order No. supplement for transverse auxiliary switches

None
1 NO + 1 NC

▶
B

Additional price³⁾

0 None
5 X

- 1) Standard value for 4-pole standard motors at 50 Hz 400 V AC. The actual starting and rated data of the motor to be protected must be considered when selecting the units.
- 2) Weights are specified for variants with auxiliary switch.
- 3) Totals are rounded up and down. This may lead to slight differences in the overall price.







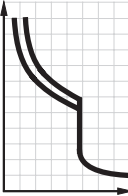

Auxiliary switches can also be ordered separately (see "Mountable Accessories").

Multi-unit/reusable packaging, see "Appendix" --> "Ordering Notes".

3RV Motor Starter Protectors up to 100 A

For motor protection

Class 10, without auxiliary switches

	Rated current	Suitable for three-phase induction motors ¹⁾ with P	Setting range for thermal overload release	Instantaneous overcurrent release	Short-circuit breaking capacity at 400 V AC	DT	Screw connection	PU (UNIT, SET, M)	PS*	PG	Weight per PU approx.	
	I_n				I_{cu}		Order No.	Price per PU			kg	
	A	kW	A	A	kA							
Size S2												
	16	7.5	11 ... 16	208	50	▶	3RV10 31-4AA10		1	1 unit	101	1.046
	20	7.5	14 ... 20	260	50	▶	3RV10 31-4BA10		1	1 unit	101	1.043
	25	11	18 ... 25	325	50	▶	3RV10 31-4DA10		1	1 unit	101	1.031
	32	15	22 ... 32	416	50	▶	3RV10 31-4EA10		1	1 unit	101	1.028
	40	18.5	28 ... 40	520	50	▶	3RV10 31-4FA10		1	1 unit	101	1.047
	45	22	36 ... 45	585	50	▶	3RV10 31-4GA10		1	1 unit	101	1.039
	50	22	40 ... 50	650	50	▶	3RV10 31-4HA10		1	1 unit	101	1.027
Size S3												
	40	18.5	28 ... 40	520	50	▶	3RV10 41-4FA10		1	1 unit	101	2.219
	50	22	36 ... 50	650	50	▶	3RV10 41-4HA10		1	1 unit	101	2.240
	63	30	45 ... 63	819	50	▶	3RV10 41-4JA10		1	1 unit	101	2.247
	75	37	57 ... 75	975	50	▶	3RV10 41-4KA10		1	1 unit	101	2.253
	90	45	70 ... 90	1170	50	▶	3RV10 41-4LA10		1	1 unit	101	2.280
	100	45	80 ... 100	1235	50	▶	3RV10 41-4MA10		1	1 unit	101	2.295
Size S3, with increased switching capacity												
	16	7.5	11 ... 16	208	100	▶	3RV10 42-4AA10		1	1 unit	101	2.174
	20	7.5	14 ... 20	260	100	▶	3RV10 42-4BA10		1	1 unit	101	2.185
	25	11	18 ... 25	325	100	▶	3RV10 42-4DA10		1	1 unit	101	2.211
	32	15	22 ... 32	416	100	▶	3RV10 42-4EA10		1	1 unit	101	2.222
	40	18.5	28 ... 40	520	100	▶	3RV10 42-4FA10		1	1 unit	101	2.203
	50	22	36 ... 50	650	100	▶	3RV10 42-4HA10		1	1 unit	101	2.230
	63	30	45 ... 63	819	100	▶	3RV10 42-4JA10		1	1 unit	101	2.255
75	37	57 ... 75	975	100	▶	3RV10 42-4KA10		1	1 unit	101	2.266	
90	45	70 ... 90	1170	100	▶	3RV10 42-4LA10		1	1 unit	101	2.268	
100	45	80 ... 100	1235	100	▶	3RV10 42-4MA10		1	1 unit	101	2.275	
Class 20, without auxiliary switches												
Size S2												
	16	7.5	11 ... 16	208	50	A	3RV10 31-4AB10		1	1 unit	101	1.067
	20	7.5	14 ... 20	260	50	A	3RV10 31-4BB10		1	1 unit	101	1.071
	25	11	18 ... 25	325	50	A	3RV10 31-4DB10		1	1 unit	101	1.054
	32	15	22 ... 32	416	50	A	3RV10 31-4EB10		1	1 unit	101	1.067
	40	18.5	28 ... 40	520	50	A	3RV10 31-4FB10		1	1 unit	101	1.076
	45	22	36 ... 45	585	50	A	3RV10 31-4GB10		1	1 unit	101	1.073
50	22	40 ... 50	650	50	A	3RV10 31-4HB10		1	1 unit	101	1.071	
Size S3, with increased switching capacity												
	40	18.5	28 ... 40	520	100	A	3RV10 42-4FB10		1	1 unit	101	2.222
	50	22	36 ... 50	650	100	A	3RV10 42-4HB10		1	1 unit	101	2.265
	63	30	45 ... 63	819	100	A	3RV10 42-4JB10		1	1 unit	101	2.278
	75	37	57 ... 75	975	100	A	3RV10 42-4KB10		1	1 unit	101	2.268
	90	45	70 ... 90	1.170	100	A	3RV10 42-4LB10		1	1 unit	101	2.313
	100	45	80 ... 100	1.235	100	A	3RV10 42-4MB10		1	1 unit	101	2.322

1) Standard value for 4-pole standard motors at 50 Hz 400 V AC. The actual starting and rated data of the motor to be protected must be considered when selecting the units.

Auxiliary switches can be ordered separately (see "Mountable Accessories").

Multi-unit/reusable packaging, see "Appendix" --> "Ordering Notes".

* You can order this quantity or a multiple thereof.

3RV Motor Starter Protectors up to 100 A

For motor protection with overload relay function

Selection and ordering data

CLASS 10, with overload relay functions (automatic reset), without auxiliary switches

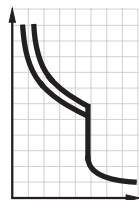

Rated current	Suitable for three-phase induction motors ¹⁾ with P	Setting range for thermal overload release	Instantaneous over-current release	Short-circuit breaking capacity at 400 V AC	DT	Screw connection	PU (UNIT, SET, M)	PS*	PG	Weight per PU approx.
I_n				I_{cu}		Order No.	Price per PU			kg
A	kW	A	A	kA						

Size S0²⁾



0.16	0.04	0.11 ... 0.16	2.1	100	A	3RV11 21-0AA10	1	1 unit	101	0.354
0.2	0.06	0.14 ... 0.2	2.6	100	A	3RV11 21-0BA10	1	1 unit	101	0.358
0.25	0.06	0.18 ... 0.25	3.3	100	A	3RV11 21-0CA10	1	1 unit	101	0.352
0.32	0.09	0.22 ... 0.32	4.2	100	A	3RV11 21-0DA10	1	1 unit	101	0.352
0.4	0.09	0.28 ... 0.4	5.2	100	A	3RV11 21-0EA10	1	1 unit	101	0.355
0.5	0.12	0.35 ... 0.5	6.5	100	A	3RV11 21-0FA10	1	1 unit	101	0.356
0.63	0.18	0.45 ... 0.63	8.2	100	A	3RV11 21-0GA10	1	1 unit	101	0.358
0.8	0.18	0.55 ... 0.8	10	100	A	3RV11 21-0HA10	1	1 unit	101	0.421
1	0.25	0.7 ... 1	13	100	A	3RV11 21-0JA10	1	1 unit	101	0.416
1.25	0.37	0.9 ... 1.25	16	100	A	3RV11 21-0KA10	1	1 unit	101	0.426
1.6	0.55	1.1 ... 1.6	21	100	A	3RV11 21-1AA10	1	1 unit	101	0.422
2	0.75	1.4 ... 2	26	100	A	3RV11 21-1BA10	1	1 unit	101	0.427
2.5	0.75	1.8 ... 2.5	33	100	A	3RV11 21-1CA10	1	1 unit	101	0.422
3.2	1.1	2.2 ... 3.2	42	100	A	3RV11 21-1DA10	1	1 unit	101	0.428
4	1.5	2.8 ... 4	52	100	A	3RV11 21-1EA10	1	1 unit	101	0.420
5	1.5	3.5 ... 5	65	100	A	3RV11 21-1FA10	1	1 unit	101	0.429
6.3	2.2	4.5 ... 6.3	82	100	A	3RV11 21-1GA10	1	1 unit	101	0.426
8	3	5.5 ... 8	104	100	A	3RV11 21-1HA10	1	1 unit	101	0.425
10	4	7 ... 10	130	100	A	3RV11 21-1JA10	1	1 unit	101	0.428
12.5	5.5	9 ... 12.5	163	100	A	3RV11 21-1KA10	1	1 unit	101	0.426
16	7.5	11 ... 16	208	50	A	3RV11 21-4AA10	1	1 unit	101	0.436
20	7.5	14 ... 20	260	50	A	3RV11 21-4BA10	1	1 unit	101	0.430
22	11	17 ... 22	286	50	A	3RV11 21-4CA10	1	1 unit	101	0.427
25	11	20 ... 25	325	50	A	3RV11 21-4DA10	1	1 unit	101	0.432

Size S2²⁾



16	7.5	11 ... 16	208	50	A	3RV11 31-4AA10	1	1 unit	101	1.123
20	7.5	14 ... 20	260	50	A	3RV11 31-4BA10	1	1 unit	101	1.109
25	11	18 ... 25	325	50	A	3RV11 31-4DA10	1	1 unit	101	1.114
32	15	22 ... 32	416	50	A	3RV11 31-4EA10	1	1 unit	101	1.111
40	18.5	28 ... 40	520	50	A	3RV11 31-4FA10	1	1 unit	101	1.123
45	22	36 ... 45	585	50	A	3RV11 31-4GA10	1	1 unit	101	1.101
50	22	40 ... 50	650	50	A	3RV11 31-4HA10	1	1 unit	101	1.106

Size S3, with increased switching capacity²⁾



16	7.5	11 ... 16	208	100	A	3RV11 42-4AA10	1	1 unit	101	2.247
20	7.5	14 ... 20	260	100	A	3RV11 42-4BA10	1	1 unit	101	2.255
25	11	18 ... 25	325	100	A	3RV11 42-4DA10	1	1 unit	101	2.284
32	15	22 ... 32	416	100	A	3RV11 42-4EA10	1	1 unit	101	2.295
40	18.5	28 ... 40	520	100	A	3RV11 42-4FA10	1	1 unit	101	2.288
50	22	36 ... 50	650	100	A	3RV11 42-4HA10	1	1 unit	101	2.320
63	30	45 ... 63	819	100	A	3RV11 42-4JA10	1	1 unit	101	2.333
75	37	57 ... 75	975	100	A	3RV11 42-4KA10	1	1 unit	101	2.368
90	45	70 ... 90	1170	100	A	3RV11 42-4LA10	1	1 unit	101	2.353
100	45	80 ... 100	1235	100	A	3RV11 42-4MA10	1	1 unit	101	2.346

1) Standard value for 4-pole standard motors at 50 Hz 400 V AC. The actual starting and rated data of the motor to be protected must be considered when selecting the units.

2) Accessories for mounting on the right (for series S0 to S3) and 3RV19 15 three-phase busbars (for size S0) cannot be used.

Auxiliary switches can be ordered separately (see "Mountable accessories").

Multi-unit/reusable packaging, see "Appendix" --> "Ordering Notes".



3RV Motor Starter Protectors up to 100 A

For starter combinations

Selection and ordering data

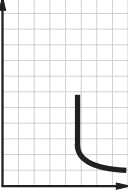
Without auxiliary switches



Rated current	Suitable for three-phase induction motors ¹⁾ with P	Setting range for thermal overload release ²⁾	Instantaneous over-current release	Short-circuit breaking capacity at 400 V AC	DT	Screw connection	PU (UNIT, SET, M)	PS*	PG	Weight per PU approx.
I_n				I_{cu}		Order No.	Price per PU			kg
A	kW	A	A	kA						

Size S0



0.16	0.04	None	2.1	100	A	3RV13 21-0AC10	1	1 unit	101	0.282
0.2	0.06	None	2.6	100	A	3RV13 21-0BC10	1	1 unit	101	0.284
0.25	0.06	None	3.3	100	A	3RV13 21-0CC10	1	1 unit	101	0.285
0.32	0.09	None	4.2	100	A	3RV13 21-0DC10	1	1 unit	101	0.282
0.4	0.09	None	5.2	100	A	3RV13 21-0EC10	1	1 unit	101	0.286
0.5	0.12	None	6.5	100	A	3RV13 21-0FC10	1	1 unit	101	0.283
0.63	0.18	None	8.2	100	A	3RV13 21-0GC10	1	1 unit	101	0.348
0.8	0.18	None	10	100	A	3RV13 21-0HC10	1	1 unit	101	0.283
1	0.25	None	13	100	A	3RV13 21-0JC10	1	1 unit	101	0.345
1.25	0.37	None	16	100	A	3RV13 21-0KC10	1	1 unit	101	0.351
1.6	0.55	None	21	100	A	3RV13 21-1AC10	1	1 unit	101	0.352
2	0.75	None	26	100	A	3RV13 21-1BC10	1	1 unit	101	0.352
2.5	0.75	None	33	100	A	3RV13 21-1CC10	1	1 unit	101	0.352
3.2	1.1	None	42	100	A	3RV13 21-1DC10	1	1 unit	101	0.353
4	1.5	None	52	100	A	3RV13 21-1EC10	1	1 unit	101	0.349
5	1.5	None	65	100	A	3RV13 21-1FC10	1	1 unit	101	0.354
6.3	2.2	None	82	100	A	3RV13 21-1GC10	1	1 unit	101	0.355
8	3	None	104	100	A	3RV13 21-1HC10	1	1 unit	101	0.354
10	4	None	130	100	A	3RV13 21-1JC10	1	1 unit	101	0.357
12.5	5.5	None	163	100	A	3RV13 21-1KC10	1	1 unit	101	0.354
16	7.5	None	208	50	A	3RV13 21-4AC10	1	1 unit	101	0.362
20	7.5	None	260	50	A	3RV13 21-4BC10	1	1 unit	101	0.357
22	11	None	286	50	A	3RV13 21-4CC10	1	1 unit	101	0.358
25	11	None	325	50	A	3RV13 21-4DC10	1	1 unit	101	0.359

Size S2



16	7.5	None	208	50	A	3RV13 31-4AC10	1	1 unit	101	1.038
20	7.5	None	260	50	A	3RV13 31-4BC10	1	1 unit	101	1.037
25	11	None	325	50	A	3RV13 31-4DC10	1	1 unit	101	1.014
32	15	None	416	50	A	3RV13 31-4EC10	1	1 unit	101	1.018
40	18.5	None	520	50	A	3RV13 31-4FC10	1	1 unit	101	1.033
45	22	None	585	50	A	3RV13 31-4GC10	1	1 unit	101	1.040
50	22	None	650	50	A	3RV13 31-4HC10	1	1 unit	101	1.019

Size S3



40	18.5	None	520	50	A	3RV13 41-4FC10	1	1 unit	101	2.197
50	22	None	650	50	A	3RV13 41-4HC10	1	1 unit	101	2.227
63	30	None	819	50	A	3RV13 41-4JC10	1	1 unit	101	2.244
75	37	None	975	50	A	3RV13 41-4KC10	1	1 unit	101	2.247
90	45	None	1170	50	A	3RV13 41-4LC10	1	1 unit	101	2.269
100	45	None	1235	50	A	3RV13 41-4MC10	1	1 unit	101	2.292

Size S3, with increased switching capacity



16	7.5	None	208	100	A	3RV13 42-4AC10	1	1 unit	101	2.175
20	7.5	None	260	100	A	3RV13 42-4BC10	1	1 unit	101	2.188
25	11	None	325	100	A	3RV13 42-4DC10	1	1 unit	101	2.219
32	15	None	416	100	A	3RV13 42-4EC10	1	1 unit	101	2.208
40	18.5	None	520	100	A	3RV13 42-4FC10	1	1 unit	101	2.218
50	22	None	650	100	A	3RV13 42-4HC10	1	1 unit	101	2.218
63	30	None	819	100	A	3RV13 42-4JC10	1	1 unit	101	2.248
75	37	None	975	100	A	3RV13 42-4KC10	1	1 unit	101	2.278
90	45	None	1170	100	A	3RV13 42-4LC10	1	1 unit	101	2.266
100	45	None	1235	100	A	3RV13 42-4MC10	1	1 unit	101	2.293

1) Standard value for 4-pole standard motors at 50 Hz 400 V AC. The actual starting and rated data of the motor to be protected must be considered when selecting the units.

2) For overload protection of the motors, appropriate overload relays must be used.

Auxiliary switches can be ordered separately (see "Mountable Accessories").

Multi-unit/reusable packaging, see "Appendix" --> "Ordering Notes".

* You can order this quantity or a multiple thereof.

3RV Motor Starter Protectors up to 100 A

For transformer protection

Selection and ordering data

Class 10, without auxiliary switches

Motor starter protectors for the protection of transformers with high inrush current.

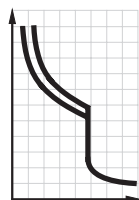

Rated current	Setting range for thermal overload release	Instantaneous overcurrent release	Short-circuit breaking capacity at 400 V AC	DT	Screw connection	PU (UNIT, SET, M)	PS*	PG	Weight per PU approx.
I_n		$I >$	I_{cu}		Order No.	Price per PU			kg
A	A	A	kA						

Size S0

	0.16	0.11 ... 0.16	3.3	100	▶	3RV14 21-0AA10	1	1 unit	101	0.286
	0.2	0.14 ... 0.2	4.2	100	▶	3RV14 21-0BA10	1	1 unit	101	0.287
	0.25	0.18 ... 0.25	5.2	100	▶	3RV14 21-0CA10	1	1 unit	101	0.286
	0.32	0.22 ... 0.32	6.5	100	▶	3RV14 21-0DA10	1	1 unit	101	0.288
	0.4	0.28 ... 0.4	8.2	100	▶	3RV14 21-0EA10	1	1 unit	101	0.287
	0.5	0.35 ... 0.5	10	100	▶	3RV14 21-0FA10	1	1 unit	101	0.286
	0.63	0.45 ... 0.63	13	100	▶	3RV14 21-0GA10	1	1 unit	101	0.290
	0.8	0.55 ... 0.8	16	100	▶	3RV14 21-0HA10	1	1 unit	101	0.290
	1	0.7 ... 1	21	100	▶	3RV14 21-0JA10	1	1 unit	101	0.353
	1.25	0.9 ... 1.25	26	100	▶	3RV14 21-0KA10	1	1 unit	101	0.354
	1.6	1.1 ... 1.6	33	100	▶	3RV14 21-1AA10	1	1 unit	101	0.353
	2	1.4 ... 2	42	100	▶	3RV14 21-1BA10	1	1 unit	101	0.358
	2.5	1.8 ... 2.5	52	100	▶	3RV14 21-1CA10	1	1 unit	101	0.354
	3.2	2.2 ... 3.2	65	100	▶	3RV14 21-1DA10	1	1 unit	101	0.358
	4	2.8 ... 4	82	100	▶	3RV14 21-1EA10	1	1 unit	101	0.354
	5	3.5 ... 5	104	100	▶	3RV14 21-1FA10	1	1 unit	101	0.357
6.3	4.5 ... 6.3	130	100	▶	3RV14 21-1GA10	1	1 unit	101	0.356	
8	5.5 ... 8	163	100	▶	3RV14 21-1HA10	1	1 unit	101	0.358	
10	7 ... 10	208	100	▶	3RV14 21-1JA10	1	1 unit	101	0.362	
12.5	9 ... 12.5	260	100	▶	3RV14 21-1KA10	1	1 unit	101	0.360	
16	11 ... 16	286	50	▶	3RV14 21-4AA10	1	1 unit	101	0.365	
20	14 ... 20	325	50	▶	3RV14 21-4BA10	1	1 unit	101	0.365	

Size S2

	16	11 ... 16	325	50	▶	3RV14 31-4AA10	1	1 unit	101	1.029
	20	14 ... 20	416	50	▶	3RV14 31-4BA10	1	1 unit	101	1.034
	25	18 ... 25	520	50	▶	3RV14 31-4DA10	1	1 unit	101	1.038
	32	22 ... 32	660	50	▶	3RV14 31-4EA10	1	1 unit	101	1.029
	40	28 ... 40	836	50	▶	3RV14 31-4FA10	1	1 unit	101	1.039

Auxiliary switches can be ordered separately (see "Mountable Accessories").

Multi-unit/reusable packaging, see "Appendix" --> "Ordering Notes".

3RV Motor Starter Protectors up to 100 A

For fuse monitoring

Selection and ordering data

Without auxiliary switches

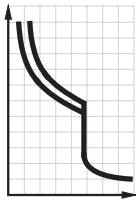

Rated current	Thermal overload release	Instantaneous overcurrent release	Short-circuit breaking capacity at 400 V AC	DT	Screw connection	PU (UNIT, SET, M)	PS*	PG	Weight per PU approx.
I_n		$I >$	I_{cu}		Order No.	Price per PU			kg
A	A	A	kA						

Size S00



0.2	0.2	1.2	100	▶	3RV16 11-0BD10		1	1 unit	101	0.289
-----	-----	-----	-----	---	-----------------------	--	---	--------	-----	-------

Multi-unit/reusable packaging, see "Appendix" --> "Ordering Notes".

The auxiliary switch required for signaling can be ordered separately.

Type	Version	DT	Order No.	Price per PU	PU (UNIT, SET, M)	PS*	PG	Weight per PU approx.
								kg

Mountable auxiliary switches



Transverse auxiliary switches with screw connection	1 NO + 1 NC	▶	3RV19 01-1E		1	1 unit	101	0.018
---	-------------	---	--------------------	--	---	--------	-----	-------

3RV19 01-1E



Lateral auxiliary switches with screw connection	1 NO + 1 NC	▶	3RV19 01-1A		1	1 unit	101	0.045
--	-------------	---	--------------------	--	---	--------	-----	-------

3RV19 01-1A

For further auxiliary switches, see "Mountable accessories".

* You can order this quantity or a multiple thereof.



3RV Motor Starter Protectors up to 100 A

For plant protection according to
UL 489 / CSA C22.2 No. 5-02

Selection and ordering data

Class 10, without auxiliary switches

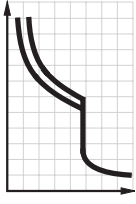
Motor starter protectors for plant protection according to UL/CSA.

	Rated current	Setting range for thermal overload release (non-adjustable)	Instantaneous overcurrent release	Short-circuit breaking capacity at 400 V AC	DT	Screw connection	PU (UNIT, SET, M)	PS*	PG	Weight per PU approx.
	I_n A	 A	 A	I_{cu} kA		Order No.	Price per PU			kg

Size S3





10	10	150	100	B	3RV17 42-5AD10	1	1 unit	101	2.200
15	15	225	100	B	3RV17 42-5BD10	1	1 unit	101	2.200
20	20	260	100	B	3RV17 42-5CD10	1	1 unit	101	2.200
25	25	325	100	B	3RV17 42-5DD10	1	1 unit	101	2.200
30	30	390	100	B	3RV17 42-5ED10	1	1 unit	101	2.200
35	35	455	100	B	3RV17 42-5FD10	1	1 unit	101	2.200
40	40	520	100	B	3RV17 42-5GD10	1	1 unit	101	2.200
45	45	585	100	B	3RV17 42-5HD10	1	1 unit	101	2.200
50	50	650	100	B	3RV17 42-5JD10	1	1 unit	101	2.200
60	60	780	100	B	3RV17 42-5LD10	1	1 unit	101	2.200
70	70	910	100	B	3RV17 42-5PD10	1	1 unit	101	2.200

3RV Motor Starter Protectors up to 100 A

For distance protection

Selection and ordering data

Voltage transformer circuit-breakers with auxiliary switches

Rated current	Thermal overload release	Instantaneous overcurrent release	Auxiliary switch integrated in the circuit-breaker, transverse	Short-circuit breaking capacity at 400 V AC	DT	Screw connection	PU (UNIT, SET, M)	PS*	PG	Weight per PU approx.
I_n				I_{cu}		Order No.	Price per PU			kg
A	A	A		kA						

Size S00



1.4	1.4	6	1 CO	50	B	3RV16 11-1AG14	1	1 unit	101	0.314
2.5	2.5	10.5	1 CO	50	▶	3RV16 11-1CG14	1	1 unit	101	0.318
3	3	20	1 CO	50	▶	3RV16 11-1DG14	1	1 unit	101	0.315

Type	Version	DT	Order No.	Price per PU	PU (UNIT, SET, M)	PS*	PG	Weight per PU approx.
								kg

Laterally mountable auxiliary switches for other signaling purposes



Lateral auxiliary switches	1 NO + 1 NC	▶	3RV19 01-1A		1	1 unit	101	0.045
----------------------------	-------------	---	--------------------	--	---	--------	-----	-------

3RV19 01-1A

For further auxiliary switches, see "Mountable Accessories".

More information

Conversion of voltage transformer circuit-breakers 3VU13 to 3RV1

The 3VU13 voltage transformer circuit-breakers previously available have been discontinued. The 3RV1 voltage transformer circuit-breakers are offered as replacement types.

Previous type	Replacement type
3VU13 11-6HR00	3RV16 11-1CG14
3VU13 21-6HR00	3RV16 11-1CG14 + 3RV19 01-1A
3VU13 11-6JR00	3RV16 11-1DG14

* You can order this quantity or a multiple thereof.

3RV Motor Starter Protectors up to 100 A

Accessories

Mountable accessories

Overview

Mounting location and function

The 3RV1 motor starter protectors have three main contact elements. In order to achieve maximum flexibility, auxiliary switches, alarm switches, auxiliary releases and isolator modules can be supplied separately.

These components can be fitted as required on the motor starter protectors without using tools.

<p>Front</p> <p><i>Notes:</i></p> <ul style="list-style-type: none"> A maximum of 4 auxiliary contacts with auxiliary switches can be attached to each motor starter protector. Transverse auxiliary switches must not be used for the 3RV17 motor starter protectors. 	<p>Transverse auxiliary switches</p> <p>1 NO + 1 NC</p> <p>or</p> <p>2 NO</p> <p>or 1 changeover contact</p>	<p>An auxiliary contact block can be inserted transversely on the front. The overall width of the motor starter protectors remains unchanged.</p>
<p>Left-hand side</p> <p><i>Notes:</i></p> <ul style="list-style-type: none"> Auxiliary switches (2 contacts) and alarm switches can be mounted separately or together. A maximum of 4 auxiliary contacts with auxiliary switches can be attached to each motor starter protector. 	<p>Lateral auxiliary switches (2 contacts)</p> <p>1 NO + 1 NC</p> <p>or</p> <p>2 NO</p> <p>or</p> <p>2 NC</p> <hr/> <p>Lateral auxiliary switches (4 contacts)</p> <p>2 NO + 2 NC</p> <hr/> <p>Alarm switches for sizes S0, S2, and S3</p> <p>Trip 1 NO + 1 NC</p> <p>Short-circuit 1 NO + 1 NC</p>	<p>One of the three auxiliary switches can be mounted laterally for each motor starter protector. The contacts of the auxiliary switch close and open together with the main contacts of the motor starter protector.</p> <p>The overall width of the lateral auxiliary switch with 2 contacts is 9 mm.</p> <hr/> <p>One auxiliary switch can be mounted laterally for each motor starter protector. The contacts of the auxiliary switch close and open together with the main contacts of the motor starter protector.</p> <p>The overall width of the lateral auxiliary switch with 4 contacts is 18 mm.</p> <hr/> <p>One alarm switch can be mounted at the side of each motor starter protector with a rotary operating mechanism.</p> <p>The alarm switch has two contact systems.</p> <p>One contact system always signals tripping irrespective of whether this was caused by a short-circuit, an overload or an auxiliary release. The other contact system only switches in the event of a short-circuit. There is no signaling as a result of <u>switching off</u> with the handle.</p> <p>In order to be able to switch on the motor starter protector again after a short-circuit, the alarm switch must be reset manually after the error cause has been eliminated.</p> <p>The overall width of the alarm switch is 18 mm.</p>
<p>Right-hand side</p> <p><i>Notes:</i></p> <ul style="list-style-type: none"> One auxiliary release can be mounted per motor starter protector. Accessories cannot be mounted at the right-hand side of the 3RV11 motor starter protectors with overload relay function. 	<p>Shunt release</p> <p>or</p> <hr/> <p>Undervoltage release</p> <p>or</p> <hr/> <p>Undervoltage release with leading auxiliary contacts (2 NO)</p>	<p>For remote-controlled tripping of the motor starter protector. The release coil should only be energized for short periods (see schematics).</p> <hr/> <p>Trips the motor starter protector when the voltage is interrupted and prevents the motor from being restarted accidentally when the voltage is restored. Used for remote-controlled tripping of the motor starter protector.</p> <p>Particularly suitable for EMERGENCY-STOP disconnection by way of the corresponding EMERGENCY-STOP button according to DIN VDE 0113.</p> <hr/> <p>Function and use as for the undervoltage release without leading auxiliary contacts, but with the following additional function: the auxiliary contacts will open in switch position OFF to deenergize the coil of the undervoltage release, thus interrupting power consumption. In the "tripped" position, these auxiliary contacts are not guaranteed to open. The leading contacts permit the motor starter protector to reclose.</p> <p>The overall width of the auxiliary release is 18 mm.</p>
<p>Top</p> <p><i>Note:</i></p> <p>The isolator module covers the terminal screws of the transverse auxiliary switch. If the isolator module is used, we therefore recommend that either the lateral auxiliary switches be fitted or that the isolator module not be mounted until the auxiliary switch has been wired.</p>	<p>Isolator modules for motor starter protectors</p> <p>Size S0 and S2</p>	<p>Isolator modules can be mounted to the upper terminal end of motor starter protectors of sizes S0 and S2.</p> <p>The supply cable is connected to the motor starter protector through the isolator module.</p> <p>The plug can only be unplugged when the motor starter protector is open and isolates all 3 poles of the motor starter protector from the network. The shock-protected isolation point is clearly visible and secured with a padlock to prevent reinsertion of the plug.</p>

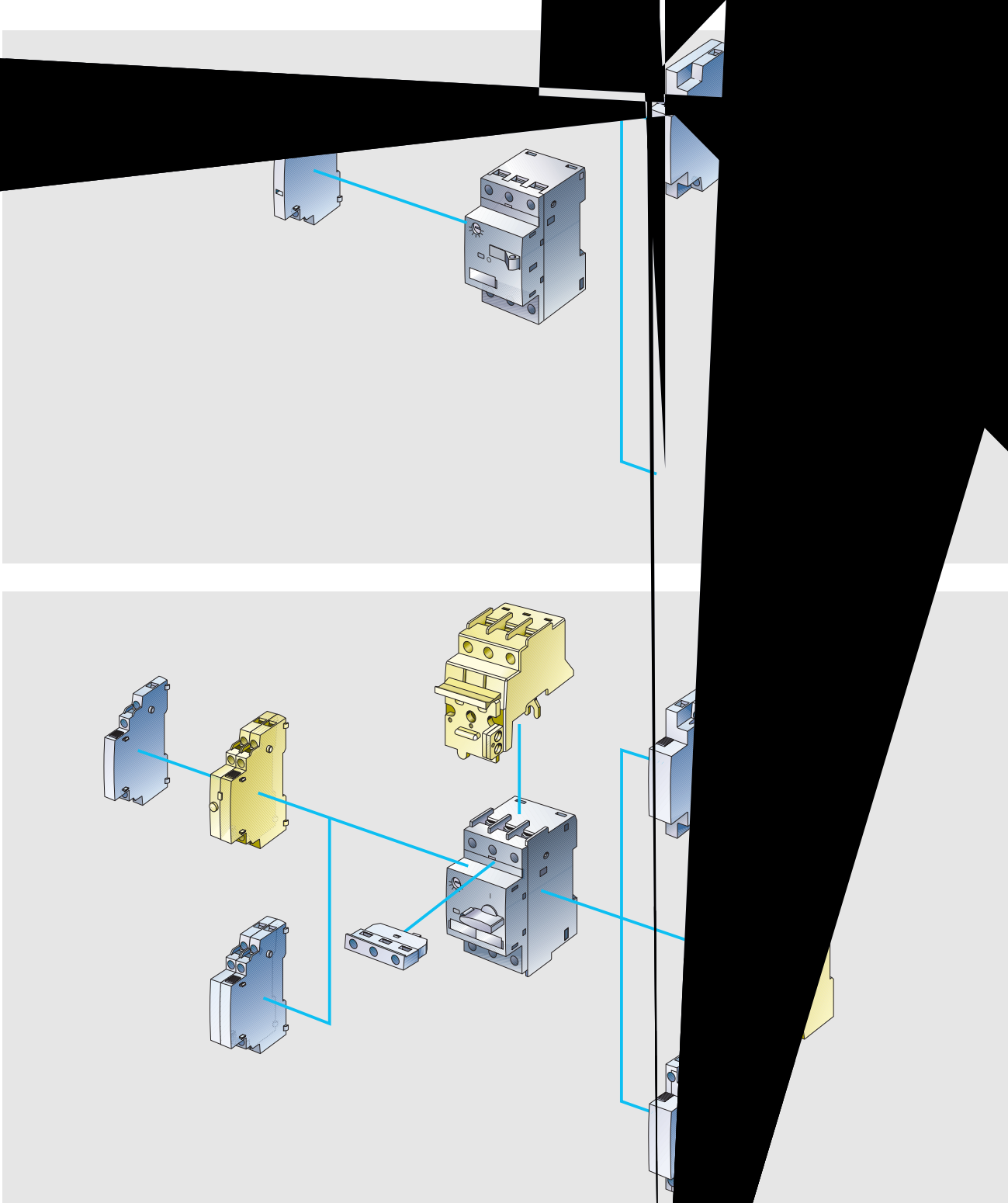





3RV Motor Starter Protectors up to 100 A

Accessories



Mountable accessories

Selection and ordering data

Type	Version	For motor starter protectors Size	DT	Screw connection	PU (UNIT, SET, M)	PS*	PG	Weight per PU approx. kg	
				Order No.	Price per PU				
Auxiliary switches¹⁾									
 3RV19 01-1E	Transverse auxiliary switches with screw connection	1 CO 1 NO + 1 NC 2 NO ²⁾	S00, S0, S2, S3	▶ 3RV19 01-1D ▶ 3RV19 01-1E ▶ 3RV19 01-1F		1 1 1	1 unit 1 unit 1 unit	101 101 101	0.015 0.018 0.018
 3RV19 01-1G	Solid-state compatible transverse auxiliary switches with screw connection for use in dusty atmosphere and in solid-state circuits with low operating currents	1 CO	S00, S0, S2, S3	A 3RV19 01-1G		1	1 unit	101	0.016
 3RV19 01-0H	Covering caps for transverse auxiliary switches		S00, S0, S2, S3	A 3RV19 01-0H		1	10 units	101	0.006
 3RV19 01-1A	Lateral auxiliary switches with screw connection	1 NO + 1 NC 2 NO 2 NC 2 NO + 2 NC	S00, S0, S2, S3	▶ 3RV19 01-1A ▶ 3RV19 01-1B ▶ 3RV19 01-1C ▶ 3RV19 01-1J		1 1 1 1	1 unit 1 unit 1 unit 1 unit	101 101 101 101	0.045 0.045 0.045 0.083
 3RV19 01-1J									

1) Each motor starter protector can be fitted with one transverse and one lateral auxiliary switch. The lateral auxiliary switch with 2 NO + 2 NC is used without a transverse auxiliary switch.



2) Compatible with the following motor starter protectors:
 3RV1. 1 (size S00) as of version E01
 3RV1. 2 (size S0) as of version E04
 3RV1. 3 (size S2) as of version E04
 3RV1. 4 (size S3) as of version E04.

Type	Version	DT	Order No.	Price per PU	PU (UNIT, SET, M)	PS*	PG	Weight per PU approx. kg
Transverse auxiliary switches with Cage Clamp connection								
 3RV19 01-2E	1 transverse auxiliary switch can be mounted on each motor starter protector	1 NO + 1 NC 2 NO	▶ 3RV19 01-2E ▶ 3RV19 01-2F		1 1	1 unit 1 unit	101 101	0.017 0.018
Laterally mountable auxiliary switches with Cage Clamp connection								
 3RV19 01-2A	1 lateral auxiliary switch can be mounted on the left for each motor starter protector	1 NO + 1 NC 2 NO 2 NC	▶ 3RV19 01-2A ▶ 3RV19 01-2B ▶ 3RV19 01-2C		1 1 1	1 unit 1 unit 1 unit	101 101 101	0.040 0.040 0.040

3RV Motor Starter Protectors up to 100 A

Accessories

Mountable accessories



Type	Version	For motor starter protectors Size	DT	Screw connection	PU (UNIT, SET, M)	PS*	PG	Weight per PU approx.	
				Order No.	Price per PU				
kg									
Alarm switches¹⁾									
 3RV19 21-1M	Alarm switches	Separate tripped and short-circuit alarms, each 1 NO + 1 NC.	S0, S2, S3	▶	3RV19 21-1M	1	1 unit	101	0.094
				A					
Isolator modules									
 3RV19 38-1A with padlock	Isolator modules	Visible isolating distance for isolating individual motor starter protectors from the network, lockable in isolating position.	S0	▶	3RV19 28-1A	1	1 unit	101	0.157
			S2	A	3RV19 38-1A	1	1 unit	101	0.324

1) One alarm switch can be mounted to the left of each motor starter protector.

3RV Motor Starter Protectors up to 100 A

Accessories

Mountable accessories

Rated control supply voltage U_s					For motor starter protectors Size	DT	Screw connection	PU (UNIT, SET, M)	PS*	PG	Weight per PU approx.	
AC 50 Hz	AC 60 Hz	AC 50/60 Hz 100% ON-time ¹⁾	AC/DC 50/60 Hz, DC 5 s ON-time ²⁾	DC								
V	V	V	V	V			Order No.	Price per PU			kg	
Auxiliary releases³⁾												
Undervoltage release												
	-	-	-	-	24	S00, S0, S2, S3	A	3RV19 02-1AB4	1	1 unit	101	0.138
	24	-	-	-	-		A	3RV19 02-1AB0	1	1 unit	101	0.134
	110	120	-	-	-		A	3RV19 02-1AF0	1	1 unit	101	0.134
	-	208	-	-	-		A	3RV19 02-1AM1	1	1 unit	101	0.128
	230	240	-	-	-		▶	3RV19 02-1AP0	1	1 unit	101	0.131
	400	440	-	-	-		▶	3RV19 02-1AV0	1	1 unit	101	0.127
	415	480	-	-	-		A	3RV19 02-1AV1	1	1 unit	101	0.129
	500	575	-	-	-		A	3RV19 02-1AS0	1	1 unit	101	0.127
3RV19 02-1DP0												
Undervoltage release with leading auxiliary contacts 2 NO												
	230	240	-	-	-	S00	A	3RV19 12-1CP0	1	1 unit	101	0.140
	400	-	-	-	-		A	3RV19 12-1CV0	1	1 unit	101	0.137
	415	480	-	-	-		A	3RV19 12-1CV1	1	1 unit	101	0.139
	230	240	-	-	-	S0, S2, S3	A	3RV19 22-1CP0	1	1 unit	101	0.139
	400	-	-	-	-		A	3RV19 22-1CV0	1	1 unit	101	0.136
	415	480	-	-	-		A	3RV19 22-1CV1	1	1 unit	101	0.138
3RV19 12-1CP0												
Shunt releases												
	-	-	20 ... 24	20 ... 70	-	S00, S0, S2, S3	▶	3RV19 02-1DB0	1	1 unit	101	0.133
	-	-	90 ... 110	70 ... 190	-		A	3RV19 02-1DF0	1	1 unit	101	0.135
	-	-	210 ... 240	190 ... 330	-		▶	3RV19 02-1DP0	1	1 unit	101	0.130
	-	-	350 ... 415	330 ... 500	-		A	3RV19 02-1DV0	1	1 unit	101	0.129
	-	-	500	500	-		A	3RV19 02-1DS0	1	1 unit	101	0.126

- 1) The voltage range is valid for 100 % (infinite) ON-time. The response voltage is at 0.9 the lower limit of the voltage range.
- 2) The voltage range is valid for 5 s ON-time at AC 50 Hz/60 Hz and DC. The response voltage is at 0.85 the lower limit of the voltage range.
- 3) One auxiliary release can be mounted to the right of each motor starter protector.

3RV Motor Starter Protectors up to 100 A

Accessories





Busbar accessories

Selection and ordering data

Modular spacing mm	Number of motor starter protectors that can be connected			Rated current I_n at 690 V A	For motor starter protectors Size	DT	Order No.	Price per PU	PU (UNIT, SET, M)	PS*	PG	Weight per PU approx. kg
	without lateral accessories	with lateral auxiliary switch	with auxiliary release									

3-phase busbar systems

For feeding several motor starter protectors with screw-type connection, mounted side-by-side on standard mounting rails, insulated, with touch protection.

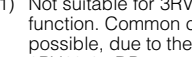
 3RV19 15-1AB	45	2	-	-	63	S00, S0 ¹⁾	▶			1	1 unit	101	0.044								
		3												▶	▶	▶	▶	1	1 unit	101	0.071
		4												▶	▶	▶	▶	1	1 unit	101	0.099
		5												▶	▶	▶	▶	1	1 unit	101	0.124
 3RV19 15-1BB	55	-	2	-	63	S00, S0 ¹⁾	▶			1	1 unit	101	0.048								
		3												▶	▶	▶	▶	1	1 unit	101	0.079
		4												▶	▶	▶	▶	1	1 unit	101	0.111
		5												▶	▶	▶	▶	1	1 unit	101	0.140
 3RV19 15-1CB	63	-	-	2	63	S00, S0 ¹⁾	▶			1	1 unit	101	0.052								
		4												▶	▶	▶	▶	1	1 unit	101	0.120
 3RV19 15-1CB	55	2	-	-	108	S2	▶			1	1 unit	101	0.140								
		3												▶	▶	▶	▶	1	1 unit	101	0.214
		4												▶	▶	▶	▶	1	1 unit	101	0.295
 3RV19 15-1DB	75	-	2	2	108	S2 ²⁾	▶			1	1 unit	101	0.161								
		3		3										▶	▶	▶	▶	1	1 unit	101	0.262
		4		4										▶	▶	▶	▶	1	1 unit	101	0.369

1) Not suitable for 3RV11 motor starter protectors with overload relay function. Common clamping of S00 and S0 motor starter protectors is not possible, due to the different modular spacings and terminal heights. The 3RV19 15-DB connector is available for connecting busbars from size S0 to size S00.

2) Auxiliary releases and lateral auxiliary switches cannot be used in combination.

Version	Modular spacing mm	For motor starter protectors Size	DT	Order No.	Price per PU	PU (UNIT, SET, M)	PS*	PG	Weight per PU approx. kg
---------	-----------------------	-----------------------------------	----	-----------	--------------	-------------------	-----	----	-----------------------------

Connectors for 3-phase busbars

 3RV19 15-5DB	45	S00, S0	▶	3RV19 15-5DB		1	1 unit	101	0.042
---	----	---------	---	--------------	--	---	--------	-----	-------

For connecting three-phase busbars for motor starter protectors of size S0 (left) to size S00 (right)

Conductor cross-section			For motor starter protectors Size	DT	Order No.	Price per PU	PU (UNIT, SET, M)	PS*	PG	Weight per PU approx. kg
Solid or stranded	Finely stranded with end sleeve	AWG conductors, solid or stranded								

3-phase line-side terminals

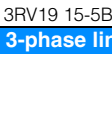
Connection from top											
	2.5 ... 25	4 ... 16	12-4	S00	▶	3RV19 15-5A		1	1 unit	101	0.043
				S0	▶	3RV19 25-5AB		1	1 unit	101	0.041
 3RV19 25-5AB	2.5 ... 25	4 ... 16	12-4	S00, S0	▶	3RV19 15-5B		1	1 unit	101	0.110
				Connection from top							
 3RV19 15-5B	2.5 ... 50	1.5 ... 35	14-0	S2	▶	3RV19 35-5A		1	1 unit	101	0.115

3-phase line-side terminals for constructing "Type E Starters"

Connection from top											
	2.5 ... 25	4 ... 16	10-4	S0	▶	3RV19 25-5EB		1	1 unit	101	0.055
				10 ... 50	-	8-0	S2	▶	3RV19 35-5E		1

1) This terminal is connected in place of a switch, please take the spacing into account.

3RV Motor Starter Protectors up to 100 A

Accessories

Busbar accessories

Version	For motor starter protectors Size	DT	Order No.	Price per PU	PU (UNIT, SET, M)	PS*	PG	Weight per PU approx. kg
---------	-----------------------------------	----	-----------	--------------	-------------------	-----	----	--------------------------

Covers for connection tags



3RV19 15-6AB

Touch protection for empty positions

S00, S0

▶ **3RV19 15-6AB**

1

10 units

101

0.003

S2

▶ **3RV19 35-6A**

1

5 units

101

0.006

Busbar adapters



8US10 61-5DJ07



8US12 51-5MD07

For motor starter protectors Size	Rated current A	Connection cable AWG	Adapter length mm	Adapter width mm	Rated voltage V	DT	Order No.	Price per PU	PU (UNIT, SET, M)	PS*	PG	Weight per PU approx. kg
-----------------------------------	-----------------	----------------------	-------------------	------------------	-----------------	----	-----------	--------------	-------------------	-----	----	--------------------------

Busbar adapters for 40 mm systems

For copper busbars according to DIN 46433
Width: 12 mm and 15 mm
Thickness: 5 mm and 10 mm

S00, S0	25	12	121	45	690	▶	8US10 51-5DJ07		1	1 unit	103	0.106
S00, S0 + lateral auxiliary switch	25	12	121	55	690	▶	8US10 61-5DJ07		1	1 unit	103	0.119
S2	56	8	139	55	690	▶	8US10 61-5FK08		1	1 unit	103	0.231
S3	100	4	182	70	400 ¹⁾	▶	8US11 11-4SM00		1	1 unit	103	0.541
S3	100	4	182	72	480 ... 690 ²⁾	▶	8US10 11-4TM00		1	1 unit	103	0.478

Busbar adapters for 60 mm systems

For copper busbars according to DIN 46433
Width: 12 mm and 30 mm
Thickness: 5 mm and 10 mm
also for T and double-T special profiles

S00, S0	25	12	182	45	690	▶	8US12 51-5DM07		1	1 unit	103	0.183
S2	56	8		55	690	▶	8US12 61-5FM08		1	6 units	103	0.263
S3	100	4		70	400 ¹⁾	▶	8US11 11-4SM00		1	1 unit	103	0.541
S3	100	4		72	480 ... 690 ²⁾	▶	8US12 11-4TM00		1	1 unit	103	0.498

1) Up to 460 V AC with max. short-circuit breaking capacity 25 kA.

2) Cannot be used for voltages < 480 V AC

Short-circuit breaking capacity 480 V/ 500 V/ 525 V AC:

- up to $I_n = 25$ A: max. 30 kA

- up to $I_n = 90$ A: max. 16 kA

- up to $I_n = 100$ A: max. 6 kA

Short-circuit breaking capacity 690 V AC:

- max. 12 kA.

For more busbar adapters, see "SIVACON Switchgear,

Distribution Systems and Cabinets " -->

"Components for Distribution Systems 8US, 8UC, 4NC"

3RV Motor Starter Protectors up to 100 A

Accessories

Rotary operating mechanisms

Overview

Door-coupling rotary operating mechanisms

Motor starter protectors with a rotary operating mechanism can be mounted in a control cabinet and operated externally by means of a door-coupling rotary operating mechanism. When the cabinet door with motor starter protector is closed, the operating mechanism is coupled. When the motor starter protector closes, the coupling is locked which prevents the door from being opened unintentionally. This lock can be defeated by the maintenance personnel. In the Open position, the rotary operating mechanism can be secured against reclosing with up to 3 padlocks. Inadvertent opening of the door is not possible in this case either.

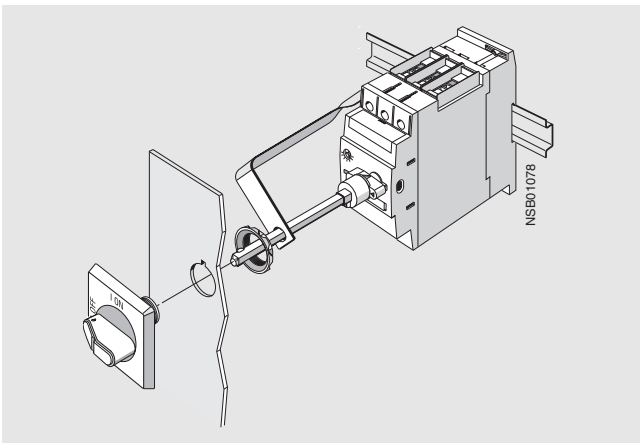

3RV19 26-0K door-coupling rotary operating mechanism

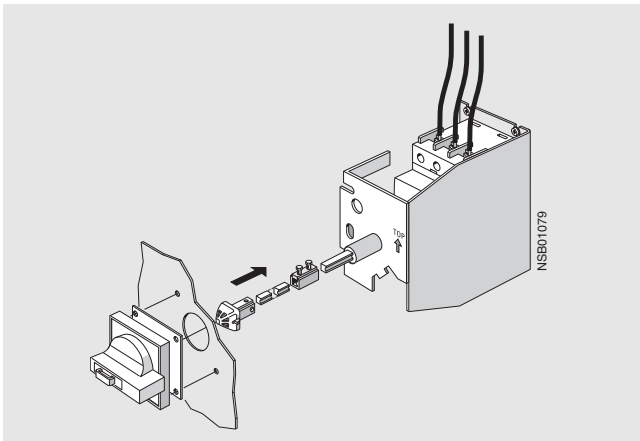

3RV19 26-2B door-coupling rotary operating mechanism for arduous conditions

Remote motorized operating mechanisms

3RV1 motor starter protectors are manually operated controls. They automatically trip in case of an overload or short-circuit. Intentional remote-controlled tripping is possible by means of a shunt release or an undervoltage release. Reclosing is only possible directly at the motor starter protector.

The remote motorized operating mechanism allows the motor starter protectors to be opened and closed by electrical commands. This enables a load or an installation to be isolated from the power system or reconnected to it from an operator panel.

If the motor starter protector is tripped as a result of overload or short-circuit, it will be in tripped position. For reclosing, the remote motorized operating mechanism must first be set manually or electrically to the 0 position (electrically by means of the Open command). Then it can be reclosed.

The remote motorized operating mechanism is available for motor starter protectors of size S2 ($I_{nmax} = 50 A$) and S3 ($I_{nmax} = 100 A$) that are designed for control voltages of 230 V AC and 24 V DC. The motor starter protector is fitted into the remote motorized operating mechanism as shown in the drawing.

In the "MANUAL" position, the motor starter protector in the remote motorized operating mechanism can continue to be switched manually on site. In the "AUTOMATIC" position, the motor starter protector is switched by means of electrical commands. The switching command must be applied for a minimum of 100 ms. The remote motorized operating mechanism closes the motor starter protector after a maximum of 1 second. On voltage failure during the switching operation it is ensured that the motor starter protector remains in the Open or Closed position.

Reset function

The RESET button on the motorized operating mechanism serves to reset any 3RV19 21-1M alarm switch that might be installed.

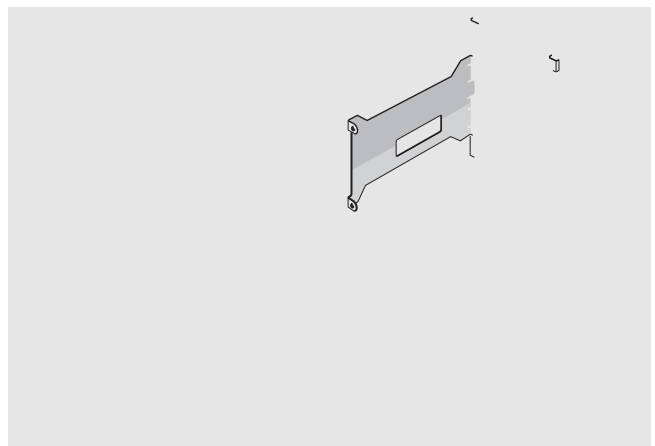

3RV Motor Starter Protectors up to 100 A

Accessories

Rotary operating mechanisms

Selection and ordering data

Type	Color of knob	Version Extension shaft mm	For motor starter protectors Size	DT	Order No.	Price per PU	PU (UNIT, SET, M)	PS*	PG	Weight per PU approx. kg
------	---------------	----------------------------------	--------------------------------------	----	-----------	--------------	-------------------	-----	----	-----------------------------

Door-coupling rotary operating mechanisms



3RV19 26-0B

The door-coupling rotary operating mechanisms consist of a knob, a coupling driver and an extension shaft of 130/330 mm in length (5 x 5 mm). The door-coupling rotary operating mechanisms are designed to the degree of protection IP65. The door locking device prevents accidental opening of the control cabinet door in the ON position of the motor starter protector. The OFF position can be locked with up to 3 padlocks.

Door-coupling rotary operating mechanisms	Black	130	S0, S2, S3	▶	3RV19 26-0B		1	1 unit	101	0.111
		330		▶	3RV19 26-0K		1	1 unit	101	0.324
EMERGENCY-STOP door-coupling rotary operating mechanisms	Red/ Yellow	130	S0, S2, S3	▶	3RV19 26-0C		1	1 unit	101	0.110
		330		▶	3RV19 26-0L		1	1 unit	101	0.316

Door-coupling rotary operating mechanisms, for arduous conditions



3RV19 26-2C

The door-coupling rotary operating mechanisms consist of a knob, a coupling driver, an extension shaft of 300 mm in length (8 x 8 mm), a spacer and two metal brackets, into which the motor starter protector is inserted. The door-coupling rotary operating mechanisms are designed to degree of protection IP65. The door locking device reliably prevents opening of the control cabinet door in the ON position of the circuit-breaker. The OFF position can be locked with up to 3 padlocks. Laterally mountable auxiliary releases and two-pole auxiliary switches can be used. The door-coupling rotary operating mechanism thus meets the requirements for isolating functions to IEC 60947-2.

Door-coupling rotary mechanisms	Gray	300	S0	▶	3RV19 26-2B		1	1 unit	101	1.180
			S2	▶	3RV19 36-2B		1	1 unit	101	1.570
			S3	▶	3RV19 46-2B		1	1 unit	101	1.722
EMERGENCY-STOP door-coupling rotary operating mechanisms	Red/ Yellow	300	S0	▶	3RV19 26-2C		1	1 unit	101	1.188
			S2	▶	3RV19 36-2C		1	1 unit	101	1.486
			S3	▶	3RV19 46-2C		1	1 unit	101	1.732

Type	Rated control supply voltage U_s	For motor starter protectors Size	DT	Order No.	Price per PU	PU (UNIT, SET, M)	PS*	PG	Weight per PU approx. kg
------	------------------------------------	--------------------------------------	----	-----------	--------------	-------------------	-----	----	-----------------------------

Remote motorized operating mechanisms



Remote motorized operating mechanisms	50/60 Hz, 230 V AC	S2	B	3RV19 36-3AP0		1	1 unit	101	3.520
	24 V DC	S2	B	3RV19 36-3AB4		1	1 unit	101	3.420
	50/60 Hz, 230 V AC	S3	B	3RV19 46-3AP0		1	1 unit	101	3.441
	24 V DC	S3	B	3RV19 46-3AB4		1	1 unit	101	3.357

* You can order this quantity or a multiple thereof.

3RV Motor Starter Protectors up to 100 A

Accessories

Mounting accessories

Overview

Soldering terminal

Soldering terminals are available for the main contacts and transverse auxiliary switches of size S00 motor starter protectors.

The prepared terminal parts are clamped to the upper and lower screw terminals of the motor starter protectors which allows them to be soldered into printed circuit boards.

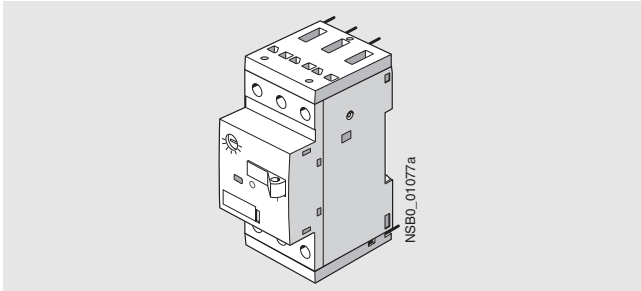

3RV19 18-5A

The 3RV19 28-1H terminal block must be used here for size S0; it is simply screwed onto the basic unit.

Basic units of size S2 are already compliant with the new clearance and creepage distance requirements.

The 3RT19 46-4GA07 terminal block must be used for size S3. The standard box terminal is to be replaced by this terminal block.

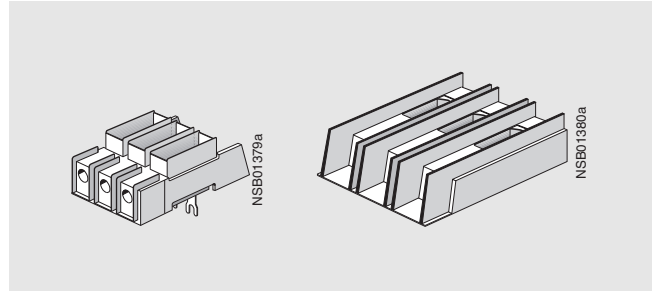

3RV19 28-1H (left), 3RT19 46-4GA07 (right)

Terminals for "Self-Protected Combination Motor Controller (Type E)" according to UL508

The 3RV10 motor starter protectors are approved according to UL508 as a "Self-Protected Combination Motor Controllers (Type E)".

As of 16 July 2001, for this application, UL 508 demands increased clearance and creepage distances (1 inch and 2 inches respectively) at the line side of the device.

According to CSA, these modular terminals can be omitted when the device is used as a "Self-Protected Combination Motor Controller" (Type E).

Three-phase line-side terminals are required for constructing "Type E Starters" with an insulated busbar system (see Busbar Accessories).

Selection and ordering data

Version	For motor starter protectors Size	DT	Order No.	Price per PU	PU (UNIT, SET, M)	PS*	PG	Weight per PU approx. kg
---------	-----------------------------------	----	-----------	--------------	-------------------	-----	----	--------------------------

Covers



3RV1 (size S3) with 3RT19 46-4EA1 (left) 3RV19 08-0P (right)

Terminal covers for box terminals Additional touch protection for fitting to box terminals (2 units can be mounted per motor starter protector)	S2	▶	3RT19 36-4EA2		1	1 unit	101	0.016
	S3	▶	3RT19 46-4EA2		1	1 unit	101	0.023
	S3	▶	3RT19 46-4EA1		1	1 unit	101	0.037
Terminal covers For cable lug and bar connection for maintaining the required voltage clearance and as touch protection if box terminal is removed (2 units can be mounted per motor starter protector)	S3	▶	3RT19 46-4EA1		1	1 unit	101	0.037
Scale covers Sealable, for covering the set current scale.	S0, S0, S2, S3	▶	3RV19 08-0P		100	10 units	101	0.100

3RV Motor Starter Protectors up to 100 A

Accessories

Mounting accessories

Type	Version	For motor starter protectors Size	DT	Order No.	Price per PU	PU (UNIT, SET, M)	PS*	PG	Weight per PU approx. kg
------	---------	-----------------------------------	----	-----------	--------------	-------------------	-----	----	-----------------------------

Fixing accessories



 3RB19 00-0B	Push-in lugs	For screwing the motor starter protector onto mounting plates. For each motor starter protector, 2 units are required.	S00, S0	▶	3RB19 00-0B		100	10 units	101	0.100
--	---------------------	--	---------	---	--------------------	--	-----	----------	-----	-------

Soldering terminals

 3RV19 18-5A with motor starter protector	For main contacts	For soldering the main conductor cross-sections of a motor starter protector to a printed circuit board (1 set = 2 parts for 1 motor starter protector)	S00	B	3RV19 18-5A		1	4 sets	101	0.030
	For main and auxiliary contacts	For soldering the main conductor connections and the auxiliary conductor connections of the transverse auxiliary switch 1NO + 1NC of a motor starter protector to a printed circuit board (1 set = 3 parts for 1 motor starter protector)	S00	B	3RV19 18-5B		1	4 sets	101	0.044

Type	Version	For motor starter protectors Size	DT	Order No.	Price per PU	PU (UNIT, SET, M)	PS*	PG	Weight per PU approx. kg
------	---------	-----------------------------------	----	-----------	--------------	-------------------	-----	----	-----------------------------

Terminals for "Self-Protected Combination Motor Controller (Type E)" according to UL508

 3RV19 28-1H	Terminal blocks Type E	For extended clearance and creepage distances (1-inch and 2-inch respectively)	S0	▶	3RV19 28-1H		1	1 unit	101	0.083
 3RT19 46-4GA07			S3	A	3RT19 46-4GA07		1	1 unit	101	0.155

Note: As of 16 July 2001, UL508 demands for "Combination Motor Controller Type E" 1-inch clearance and 2-inch creepage distance at line side. The following terminal blocks must be used in 3RV10 motor starter protectors of sizes S0 and S3. The 3RV10 motor starter protector in size S2 conforms with the required clearance and creepage distances without a terminal block. Terminal blocks are not required for use according to CSA. With size S0, these terminal blocks cannot be used in combination with 3RV19.5 three-phase busbars and with size S3, they cannot be used with a transverse auxiliary switch. For construction with 3-phase busbars, see "Busbar Accessories".

Type	Version	For motor starter protectors Size	DT	Order No.	Price per PU	PU (UNIT, SET, M)	PS*	PG	Weight per PU approx. kg
------	---------	-----------------------------------	----	-----------	--------------	-------------------	-----	----	-----------------------------





Auxiliary terminals, 3-pole

 3RT19 46-4F		For connection of auxiliary and control cables to the main conductor connections (for one side)	S3	B	3RT19 46-4F		1	1 unit	101	0.033
--	--	---	----	---	--------------------	--	---	--------	-----	-------

3RV Motor Starter Protectors up to 100 A

Accessories



Mounting accessories

Version	Method of operation	Size Contactor	Motor starter protector	DT	Order No.	Price per PU	PU (UNIT, SET, M)	PS*	PG	Weight per PU approx. kg	
Link modules, single unit packaging											
 <p>3RA19 11-1AA00</p>	For mechanical and electrical connection between contactor and motor starter protector with screw connection	AC/DC	S00	S00	▶	3RA19 11-1AA00		1	1 unit	101	0.027
			S00	S0	▶	3RA19 21-1DA00		1	1 unit	101	0.028
		AC	S0	S0	▶	3RA19 21-1AA00		1	1 unit	101	0.037
			S2	S2	▶	3RA19 31-1AA00		1	1 unit	101	0.042
			S3	S3	▶	3RA19 41-1AA00		1	1 unit	101	0.090
		DC	S0	S0	▶	3RA19 21-1BA00		1	1 unit	101	0.039
S2	S2		▶	3RA19 31-1BA00		1	1 unit	101	0.043		
S3	S3		▶	3RA19 41-1BA00		1	1 unit	101	0.089		
Link modules, multi-unit packaging											
 <p>3RA19 31-1A</p>	For mechanical and electrical connection between contactor and motor starter protector with screw connection	AC/DC	S00	S00	▶	3RA19 11-1A		1	10 units	101	0.019
			S00	S0	▶	3RA19 21-1D		1	10 units	101	0.021
		AC	S0	S0	▶	3RA19 21-1A		1	10 units	101	0.028
			S2	S2	▶	3RA19 31-1A		1	5 units	101	0.033
			S3	S3	▶	3RA19 41-1A		1	5 units	101	0.072
		DC	S0	S0	▶	3RA19 21-1B		1	10 units	101	0.030
S2	S2		▶	3RA19 31-1B		1	5 units	101	0.034		
S3	S3		▶	3RA19 41-1B		1	5 units	101	0.073		
Hybrid link modules, single-unit packaging											
 <p>3RA19 11-2FA00</p>	Electrical and mechanical connection between motor starter protector with screw terminals and contactor with Cage Clamp terminals	AC/DC	S00	S00	▶	3RA19 11-2FA00		1	1 unit	101	0.038
			S00	S0	▶	3RA19 21-2FA00		1	1 unit	101	0.028
Hybrid link modules, multi-unit packaging											
 <p>3RA19 11-2F</p>	Electrical and mechanical connection between motor starter protector with screw terminals and contactor with Cage Clamp terminals	AC/DC	S00	S00	▶	3RA19 11-2F		1	10 units	101	0.031
			S00	S0	▶	3RA19 21-2F		1	10 units	101	0.030

3RV Motor Starter Protectors up to 100 A

Accessories

Mounting accessories

Type	Version	DT	Order No.	Price per PU	PU (UNIT, SET, M)	PS*	PG	Weight per PU approx. kg	
Adapters and link modules for Cage Clamp connections									
	Link modules, Cage Clamp	Size S00	▶ 3RA19 11-2A		1	10 units	101	0.016	
	Electrical connection between motor starter protector and contactor (busbar adapter not included in scope of supply)								
	Link modules, Cage Clamp with mechanical connections	Size S00	▶ 3RA19 11-2E		1	10 units	101	0.028	
	Mechanical and electrical connection between motor starter protector and contactor								
	Adapters for rail mounting	Size S00	▶ 3RA19 22-1L		1	5 units	101	0.413	
With 2 mounting rails 45 mm wide, one adjustable									
	Busbar adapters	40 mm busbar system	▶ 8US10 51-5CM47		1	1 unit	103	0.193	
	45 mm wide, 182 mm long, adapted for Cage Clamp motor starter protectors. An additional mounting rail must be mounted for an additional contactor.								
		60 mm busbar system	▶ 8US12 51-5CM47		1	1 unit	103	0.190	
	35 mm standard mounting rails		A 8US19 98-7CA15		1	10 units	103	0.009	
Plastic, including fixing screws									

Type	Version	DT	Order No.	Price per PU	PU (UNIT, SET, M)	PS*	PG	Weight per PU approx. kg
Tools for opening Cage Clamp connections								
	For all SIRIUS devices with Cage Clamp connection, up to max. 2.5 mm ² conductor cross-section	Length approx. 175 mm	▶ 8WA2 880		1	1 unit	041	0.012
		Length; partially insulated approx. 175 mm	▶ 8WA2 803		1	1 unit	041	0.024







* You can order this quantity or a multiple thereof.

3RV Motor Starter Protectors up to 100 A

Accessories

Enclosures and front plates

Selection and ordering data

Type	Degree of protection	Integrated terminals	Overall width	For motor starter protectors Size	DT	Order No.	Price per PU	PU (UNIT, SET, M)	PS*	PG	Weight per PU approx. kg
Molded-plastic enclosures for surface mounting											
 3RV19 13-1DA00	With actuator diaphragm	IP55	N and PE/ground	54 mm (for motor starter protector + lateral auxiliary switch)	S00	▶ 3RV19 13-1CA00		1	1 unit	101	0.296
				72 mm (for motor starter protector + lateral auxiliary switch + auxiliary release)		▶ 3RV19 13-1DA00					1
 3RV19 23-1CA00	With rotary operating mechanism, lockable in 0 position	IP55	N and PE/ground	54 mm (for motor starter protector + lateral auxiliary switch)	S0	▶ 3RV19 23-1CA00		1	1 unit	101	0.332
				72 mm (for motor starter protector + lateral auxiliary switch + auxiliary release)		▶ 3RV19 23-1DA00					1
				82 mm (for motor starter protector + lateral auxiliary switch + auxiliary release)	S2	A	3RV19 33-1DA00	1	1 unit	101	1.134
	With EMERGENCY-STOP rotary operating mechanism, lockable in 0 position	IP55	N and PE/ground	54 mm (for motor starter protector + lateral auxiliary switch)	S0	▶ 3RV19 23-1FA00		1	1 unit	101	0.329
				72 mm (for motor starter protector + lateral auxiliary switch + auxiliary release)		▶ 3RV19 23-1GA00					1
				82 mm (for motor starter protector + lateral auxiliary switch + auxiliary release)	S2	A	3RV19 33-1GA00	1	1 unit	101	1.136
Cast aluminum enclosures for surface mounting											
 3RV19 23-1DA01	With rotary operating mechanism, lockable in 0 position	IP65	PE ¹⁾	72 mm (for motor starter protector + lateral auxiliary switch + auxiliary release)	S0	▶ 3RV19 23-1DA01		1	1 unit	101	1.015
	With EMERGENCY-STOP rotary operating mechanism, lockable in 0 position	IP65	PE ¹⁾	72 mm (for motor starter protector + lateral auxiliary switch + auxiliary release)	S0	A	3RV19 23-1GA01		1	1 unit	101
Molded-plastic enclosures for flush mounting											
 3RV19 13-2DA00	With actuator diaphragm	IP55 (front side)	N and PE/ground	72 mm (for motor starter protector + lateral auxiliary switch + auxiliary release)	S00	A	3RV19 13-2DA00	1	1 unit	101	0.416
 3RV19 23-2DA00	With rotary operating mechanism, lockable in 0 position	IP55 (front side)	N and PE/ground	72 mm (for motor starter protector + lateral auxiliary switch + auxiliary release)	S0	A	3RV19 23-2DA00	1	1 unit	101	0.426
 3RV19 23-2GA00	With EMERGENCY-STOP rotary operating mechanism, lockable in 0 position	IP55 (front side)	N and PE/ground	72 mm (for motor starter protector + lateral auxiliary switch + auxiliary release)	S0	A	3RV19 23-2GA00	1	1 unit	101	0.417

1) If required, an additional N terminal can be mounted (e.g. 8WA10 11-1BG11).

* You can order this quantity or a multiple thereof.

3RV Motor Starter Protectors up to 100 A

Accessories

Enclosures and front plates

Type	Degree of protection	Version	For motor starter protectors Size	DT	Order No.	Price per PU	PU (UNIT, SET, M)	PS*	PG	Weight per PU approx.
------	----------------------	---------	-----------------------------------	----	-----------	--------------	-------------------	-----	----	-----------------------

Front plates



3RV19 13-4C



3RV19 23-4B +
3RV19 23-4G

Molded-plastic front plates with actuator diaphragm	IP55 (front side)	For actuating motor starter protectors in any enclosures, includes holder for motor starter protector.	S00	A	3RV19 13-4C		1	1 unit	101	0.216
Molded-plastic front plates with rotary operating mechanism Lockable in 0 position	IP55 (front side)	For actuating 3RV1 motor starter protectors in any enclosures.	S0, S2, S3	▶	3RV19 23-4B		1	1 unit	101	0.124
Molded-plastic front plates with EMERGENCY-STOP rotary operating mechanism Red/Yellow, lockable in 0 position	IP55 (front side)	EMERGENCY-STOP actuation of 3RV1 motor starter protectors in any enclosure.	S0, S2, S3	A	3RV19 23-4E		1	1 unit	101	0.124
Holders for front plate For motor starter protectors size S0	-	Holder is mounted on front plate, motor starter protector with and without accessories is snapped in.	S0	▶	3RV19 23-4G		1	1 unit	101	0.188

Accessories for enclosures



Molded-plastic enclosure for surface mounting with 3RV19 13-7D

EMERGENCY-STOP mushroom buttons red/yellow For 3RV19 13-... enclosures and front plates, cannot be used in combination with locking device	IP55	Latching mushroom button, unlatch by turning	S00	▶	3RV19 13-7D		1	1 unit	101	0.108
EMERGENCY-STOP mushroom buttons red/yellow with safety lock For 3RV19 13-... enclosures and front plates, cannot be used in combination with locking device	IP55	Latching mushroom button, unlatch with key, Ronis safety lock, lock number SB 30, supplied with 2 keys.	S00	A	3RV19 13-7E		1	1 unit	101	0.144
Locking devices For 3RV19 13-... enclosures and front plates, cannot be used in combination with EMERGENCY-STOP mushroom button	IP55	For 3 padlocks with max. 8 mm shackle diameter.	S00	▶	3RV19 13-6B		1	1 unit	101	0.074
Spare actuator diaphragms	IP55	Diaphragm, includes holder frame and screws	S00	A	3RV19 13-7F		1	1 unit	101	0.023

Type	Version	Rated control supply voltage U_s	For motor starter protectors Size	DT	Order No.	Price per PU	PU (UNIT, SET, M)	PS*	PG	Weight per PU approx.
------	---------	------------------------------------	-----------------------------------	----	-----------	--------------	-------------------	-----	----	-----------------------

Indicator Lights



3RV19 03-5B

Indicator lights For all enclosures and front plates	With glow lamp and colored lenses red, green, yellow, orange and clear	110 ... 120	S00, S0, S2	C	3RV19 03-5B		1	1 unit	101	0.027
		220 ... 240		C	3RV19 03-5C		1	1 unit	101	0.026
		380 ... 415		C	3RV19 03-5E		1	1 unit	101	0.026
		480 ... 500		C	3RV19 03-5G		1	1 unit	101	0.027

Overview

Features	Benefits	3RU11	3RB20/3RB21	3RB22/3RB23
				
General data				
Sizes	<ul style="list-style-type: none"> • Are coordinated with the dimensions, connections and technical characteristics of the other devices in the SIRIUS modular system (contactors, soft starters, ...) • Permit the mounting of slim and compact load feeders in widths of 45 mm (S00), 45 mm (S0), 55 mm (S2), 70 mm (S3), 120 mm (S6) and 145 mm (S10/S12) • Simplify configuration 	S00 ... S3	S00 ... S12	S00 ... S12
Seamless current range	<ul style="list-style-type: none"> • Allows easy and consistent configuration with one series of overload relays (for small to large loads) 	0.11 ... 100 A	0.1 ... 630 A	0.3 ... 630 A (... 820 A) ¹⁾
Protective functions				
Tripping in the event of overload	<ul style="list-style-type: none"> • Provides optimum current-dependent protection of loads against excessive temperature rises due to overload 	✓	✓	✓
Tripping in the event of phase unbalance	<ul style="list-style-type: none"> • Provides optimum inverse-time delayed protection of loads against excessive temperature rises due to phase unbalance 	(✓)	✓	✓
Tripping in the event of phase failure	<ul style="list-style-type: none"> • Minimizes heating of three-phase motors during single-phase operation²⁾ 	✓	✓	✓
Tripping in the event of overheating	<ul style="list-style-type: none"> • Provides optimum temperature-dependent protection of loads against excessive temperature rises e.g. for stator-critical motors or in the event of insufficient coolant flow, contamination of the motor surface or for long starting or braking operations • Eliminates the need for additional special equipment • Saves space in the controlgear cabinet • Reduces wiring overhead and costs 	-- ³⁾	-- ³⁾	✓
by means of integrated thermistor motor protection function				
Tripping in the event of a ground fault	<ul style="list-style-type: none"> • Provides optimum protection of loads against high-resistance short-circuits or ground faults due to moisture, condensed water, damage to the insulation material, etc. • Eliminates the need for additional special equipment • Saves space in the controlgear cabinet • Reduces wiring overhead and costs 	--	✓ (only 3RB21)	✓
by means of internal ground fault detection (activatable)				
Features				
RESET function	<ul style="list-style-type: none"> • Allows manual or automatic resetting of the relay 	✓	✓	✓
TEST function for auxiliary contacts	<ul style="list-style-type: none"> • Allows easy checking of the function and wiring 	✓	✓	✓
TEST function for electronics	<ul style="list-style-type: none"> • Allows complete checking of the electronics 	--	✓	✓
Status display	<ul style="list-style-type: none"> • Displays the current operating status 	✓	✓	✓
Large current adjustment button	<ul style="list-style-type: none"> • Makes it easier to set the relay exactly to the correct current value 	✓	✓	✓
Integrated auxiliary contacts (1 NO + 1 NC)	<ul style="list-style-type: none"> • Allows the load to be switched off if necessary • Can be used to output signals 	✓	✓	✓ (2 ×)

1) For motor currents up to 820 A, a current measuring module, e.g. 0.3 ... 3 A, can be used in combination with a 3UF18 series transformer.

2) Single-phase operation: Abnormal operating status of a three-phase asynchronous motor where one phase is interrupted.

3) The SIRIUS 3RN thermistor motor protection devices can be used to provide additional protection temperature-dependent protection.

Overload Relays

General data

Features	Benefits	3RU11	3RB20/3RB21	3RB22/3RB23
				
Design of load feeders				
Short-circuit strength up to 100 kA at 690 V (in conjunction with the corresponding fuses or the corresponding motor starter protector)	<ul style="list-style-type: none"> Provides optimum protection of the loads and operating personnel in the event of short-circuits due to insulation faults or faulty switching operations 	✓	✓	✓
Electrical and mechanical matching to 3RT1 contactors	<ul style="list-style-type: none"> Simplifies configuration Reduces wiring overhead and costs Enables stand-alone installation as well as space-saving direct mounting 	✓	✓	✓ ¹⁾
Straight-through transformers for main circuit²⁾ (in this case the cables are routed through the push-through openings of the overload relay and connected directly to the box terminals of the contactor)	<ul style="list-style-type: none"> Reduces contact resistance (only one point of contact) Saves wiring costs (easy, no need for tools, and fast). Saves material costs Reduces installation costs 	--	✓ (S2 ... S6)	✓ (S00 ... S6)
Spring-loaded terminal connection system for main circuit²⁾	<ul style="list-style-type: none"> Enables fast connections Permits vibration-resistant connections Enables maintenance-free connections 	✓ (S00)	--	--
Spring-loaded terminal connection system for auxiliary circuits²⁾	<ul style="list-style-type: none"> Enables fast connections Permits vibration-resistant connections Enables maintenance-free connections 	✓	✓	✓
Other features				
Temperature compensation	<ul style="list-style-type: none"> Allows the use of the relays at high temperatures without derating Prevents premature tripping Allows compact installation of the controlgear cabinet without space between the units/load feeders Simplifies configuration Enables space to be saved in the controlgear cabinet 	✓	✓	✓
Very high long-term stability	<ul style="list-style-type: none"> Provides safe protection for the loads even after years of use in severe operating conditions 	(✓)	✓	✓
Wide setting ranges	<ul style="list-style-type: none"> Reduce the number of variants Minimize the engineering outlay and costs Minimize storage overhead, storage costs, tied-up capital 	--	✓ (1:4)	✓ (1:10)
Trip class CLASS 5	<ul style="list-style-type: none"> Enables solutions for very fast starting motors requiring special protection (e.g. Ex motors) 	--	✓ (only 3RB21)	✓
Trip class > CLASS 10	<ul style="list-style-type: none"> Enables heavy starting solutions 	--	✓	✓
Low power loss	<ul style="list-style-type: none"> Reduces power consumption and energy costs (up 98% less power is used than for thermal overload relays). Minimizes temperature rises of the contactor and controlgear cabinet – in some cases this may eliminate the need for controlgear cabinet cooling. Direct mounting to contactor saves space, even for high motor currents (i.e. no heat decoupling is required). 	--	✓	✓

1) Exception: up to size S3, only stand-alone installation is possible.

2) Alternatively available for screw connection.

Overload Relays

General data



Features	Benefits	3RU11	3RB20/3RB21	3RB22/3RB23
----------	----------	-------	-------------	-------------



1) The SIRIUS 3RU11 thermal overload relays use a bimetal contactor and therefore do not require an additional control circuit.

Overload Relays

General data

Overload relays	Current measurement	Current range	Contactors (type, size, rating in kW)							
			3RT10 1	3RT10 2	3RT10 3	3RT10 4	3RT10 5	3RT10 6	3RT10 7	3TF68/69
Type	Type	A	S00 3/4/5.5	S0 5.5/7.5/11	S2 15/18.5/22	S3 30/37/45	S6 55/75/90	S10 110/132/160	S12 200/250	Size 14 375/450
3RU11 thermal overload relays										
	3RU11 1	Integrated	0.11 ... 12	✓						
	3RU11 2		1.8 ... 25		✓					
	3RU11 3		5,5 ... 50			✓				
	3RU11 4		18 ... 100				✓			
3RB20/3RB21¹⁾ solid-state overload relays										
	3RB2. 1	Integrated	0.1 ... 12	✓						
	3RB2. 2		3 ... 25		✓					
	3RB2. 3		6 ... 50			✓				
	3RB2. 4		12,5 ... 100				✓			
	3RB2. 5		50 ... 200					✓		
	3RB2. 6		55 ... 630						✓	✓
3RB22/3RB23¹⁾ solid-state overload relays										
	3RB22/3RB23 + 3RB29 0		0.3 ... 25	✓	✓					
	3RB29 0		10 ... 100			✓	✓			
	3RB29 5		20 ... 200					✓		
	3RB29 6		63 ... 630						✓	✓
	3RB29 0 + 3UF18		630 ... 820							✓

1) When using the overload relays with trip class \geq CLASS 20, see Technical Specifications, Short-Circuit Protection with Fuses for Motor Feeders, and the configuring aid "Configuring SIRIUS Fuseless Load Feeders".

Overload Relays

3RB2 Solid-State Overload Relays

3RB20, 3RB21 for standard applications

Overview

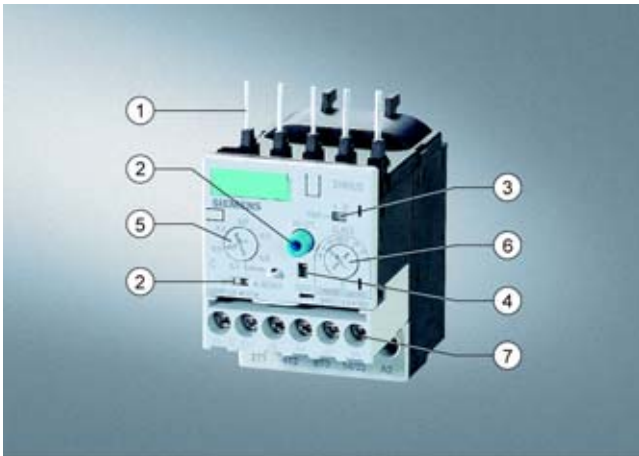

- (1) Connection for mounting onto contactors:
Optimally adapted in electrical, mechanical and design terms to the contactors and soft starters, these connecting pins can be used for direct mounting of the overload relays. Stand-alone installation is possible as an alternative (in some cases in conjunction with a stand-alone installation module).
- (2) Selector switch for manual/automatic RESET and RESET button:
With the slide switch you can choose between manual and automatic RESET. A device set to manual RESET can be reset locally by pressing the RESET button. On the 3RB21 a solid-state remote RESET is integrated.
- (3) Switch position indicator and TEST function of the wiring:
Indicates a trip and enables the wiring test.
- (4) Solid-state test:
Enables a test of all important device components and functions.
- (5) Motor current setting:
Setting the device to the rated motor current is easy with the large rotary knob.
- (6) Trip class setting/internal ground-fault detection (only 3RB21):
Using the rotary switch you can set the required trip class and activate the internal ground-fault detection dependent on the starting conditions.
- (7) Connecting terminals (removable terminal block for auxiliary circuits):
The generously sized terminals permit connection of two conductors with different cross-sections for the main and auxiliary circuits. The auxiliary circuit can be connected with screw-type terminals and alternatively with spring-loaded terminals.

The 3RB20 and 3RB21 solid-state overload relays up to 630 A with internal power supply have been designed for current-dependent protection of loads with normal and heavy starting (see LV 1 T, Function) against excessive temperature rises due to overload, phase unbalance or phase failure. An overload, phase unbalance or phase failure result in an increase of the motor current beyond the set motor rated current. This current rise is detected by the current transformers integrated into the devices and evaluated by corresponding solid-state circuits which then output a pulse to the auxiliary contacts. The auxiliary contacts then switch off the load by means of a contactor. The break time depends on the ratio between the tripping current and set current I_e and is stored in the form of a long-term stable tripping characteristic (see LV 1 T, Characteristic Curves).

In addition to current-dependent protection of loads against excessive temperature rises due to overload, phase unbalance and phase failure, the 3RB21 solid-state overload relays also allow internal ground-fault detection (not possible in conjunction with wye-delta assemblies). This provides protection of loads against high-resistance short-circuits due to damage to the insulation material, moisture, condensed water etc.

The "tripped" status is signaled by means of a switch position indicator (see LV 1 T, Function). Resetting takes place either manually or automatically after the recovery time has elapsed (see LV 1 T, Function).

The devices are manufactured in accordance with environmental guidelines and contain environmentally friendly and reusable materials. They comply with all important worldwide standards and approvals.

Benefits

The most important features and benefits of the 3RB20/3RB21 solid-state overload relays are listed in the overview table (see Overload Relays, General Data).

Overload Relays

3RB2 Solid-State Overload Relays

3RB20, 3RB21 for standard applications

Application

Industries

The 3RB20/3RB21 solid-state overload relays are suitable for customers from all industries who want to guarantee optimum inverse-time delayed protection of their electrical loads (e.g. motors) under normal and heavy starting conditions (CLASS 5 to CLASS 30), minimize project completion times, inventories and power consumption, and optimize plant availability and maintenance management.

Application

The 3RB20/3RB21 solid-state overload relays have been designed for the protection of three-phase motors in sinusoidal 50/60 Hz voltage networks. The relays are not suitable for the protection of single-phase AC or DC loads.

The 3RU11 thermal overload relay or the 3RB22/3RB23 solid-state overload relay can be used for single-phase AC loads. For DC loads we recommend the 3RU11 thermal overload relay.

Ambient conditions

The devices are insensitive to external influences such as shocks, corrosive environments, ageing and temperature changes.

For the temperature range from -25 °C to $+60\text{ °C}$, the 3RB20/3RB21 solid-state overload relays compensate the temperature according to IEC 60947-4-1.

Configuration notes for use of the devices below -25 °C or above $+60\text{ °C}$ on request.

"Increased safety" type of protection EEx e according to ATEX guideline 94/9/EC

The 3RB20/3RB21 solid-state overload relays are suitable for the overload protection of explosion-proof motors with "increased safety" type of protection EEx e. The relays meet the requirements of EN 60079-7 (Electrical apparatus for potentially explosive atmospheres – Increased safety "e").

The basic safety and health requirements of ATEX guideline 94/9/EG are fulfilled by compliance with

- EN 60947-1
- EN 60947-4-1
- EN 60947-5-1
- EN 60079-14

EU type test certificate for Group II, Category (2) G/D under application. Number on request.

Accessories

The following accessories are available for the 3RB20/3RB21 solid-state overload relays:

- One terminal bracket each for the overload relays size S00 and S0 (sizes S2 to S12 can be installed as single units without a terminal bracket)
- One mechanical remote RESET module for all sizes
- One cable release for resetting devices which are difficult to access (for all sizes)
- One sealable cover for all sizes
- Box terminals for sizes S6 and S10/S12
- Terminal covers for sizes S2 to S10/S12

Overload Relays

3RB2 Solid-State Overload Relays

3RB20, 3RB21 for standard applications

Selection and ordering data

Conversion aid 3RB10 → 3RB20

Size	Old Order No.	Setting range A	New Order No.	Setting range A
S00	3RB10 16-□RB0	0.1 ... 0.4	3RB20 16-□RB0	0.1 ... 0.4
	3RB10 16-□NB0	0.4 ... 1.6	3RB20 16-□NB0	0.32 ... 1.25
	3RB10 16-□PB0	1.5 ... 6	3RB20 16-□PB0	1 ... 4
	3RB10 16-□SB0	3 ... 12	3RB20 16-□SB0	3 ... 12
S0	3RB10 26-□RB0	0.1 ... 0.4	Use size S00	
	3RB10 26-□NB0	0.4 ... 1.6		
	3RB10 26-□PB0	1.5 ... 6		
	3RB10 26-□SB0	3 ... 12		
S2	3RB10 36-□QB0	6 ... 25	3RB20 36-□QB0	6 ... 25
	3RB10 36-□UB0	13 ... 50	3RB20 36-□UB0	12.5 ... 50
S3	3RB10 46-□UB0	13 ... 50	3RB20 46-□UB0	12.5 ... 50
	3RB10 46-□EB0	25 ... 100	3RB20 46-□EB0	25 ... 100
S6	3RB10 56-□FW0	50 ... 200	3RB20 56-□FW2	50 ... 200
	3RB10 56-□FG0		3RB20 56-□FC2	
S10/S12	3RB10 66-□GG0	55 ... 250	3RB20 66-□GC2	55 ... 250
	3RB10 66-□KG0	200 ... 540	3RB20 66-□MC2	160 ... 630
	3RB10 66-□LG0	300 ... 630		
CLASS 10	1		1	
CLASS 20	2		2	

Conversion aid 3RB10 → 3RB21

Size	Old Order No.	Setting range A	New Order No.	Setting range A
S00	3RB10 16-□RB0	0.1 ... 0.4	3RB21 13-4RB0	0.1 ... 0.4
	3RB10 16-□NB0	0.4 ... 1.6	3RB21 13-4NB0	0.32 ... 1.25
	3RB10 16-□PB0	1.5 ... 6	3RB21 13-4PB0	1 ... 4
	3RB10 16-□SB0	3 ... 12	3RB21 13-4SB0	3 ... 12
S0	3RB10 26-□RB0	0.1 ... 0.4	Use size S00	
	3RB10 26-□NB0	0.4 ... 1.6		
	3RB10 26-□PB0	1.5 ... 6		
	3RB10 26-□SB0	3 ... 12		
S2	3RB10 36-□QB0	6 ... 25	3RB21 33-4QB0	6 ... 25
	3RB10 36-□UB0	13 ... 50	3RB21 33-4UB0	12.5 ... 50
S3	3RB10 46-□UB0	13 ... 50	3RB21 43-4UB0	12.5 ... 50
	3RB10 46-□EB0	25 ... 100	3RB21 43-4EB0	25 ... 100
S6	3RB10 56-□FW0	50 ... 200	3RB21 53-4FW2	50 ... 200
	3RB10 56-□FG0		3RB21 53-4FC2	
S10/S12	3RB10 66-□GG0	55 ... 250	3RB21 63-4GC2	55 ... 250
	3RB10 66-□KG0	200 ... 540	3RB21 63-4MC2	160 ... 630
	3RB10 66-□LG0	300 ... 630		
CLASS 10	1			
CLASS 20	2			

Note:

CLASS 5, 10, 20 and 30
can be set on the unit

Overload Relays



3RB2 Solid-State Overload Relays

3RB20, 3RB21 for standard applications

3RB20 solid-state overload relays with screw connection on auxiliary current side for direct mounting¹⁾²⁾ and stand-alone installation²⁾³⁾, CLASS 10

Features and technical specifications:

- Overload protection, phase failure protection and unbalance protection
- Internal power supply
- Auxiliary contacts 1 NO + 1 NC
- Manual and automatic RESET
- Switch position indicator
- TEST function and self-monitoring

Size Con-tactor ⁴⁾	Rating for induction motor Rated value ⁵⁾	Set current value of the inverse-time delayed overload trip	Short-circuit protection with fuse, type of coordination 2, gL/gG operational class ⁶⁾	DT	Order No.	Price per PU	PU (UNIT, SET, M)	PS*	PG	Weight per PU approx.
	kW	A	A							kg
Size S00¹⁾										
	S00	0.04 ... 0.09	0.1 ... 0.4	2	▶ 3RB20 16-1RB0		1	1 unit	101	0.200
		0.12 ... 0.37	0.32 ... 1.25	6	▶ 3RB20 16-1NB0		1	1 unit	101	0.200
		0.55 ... 1.5	1 ... 4	20	▶ 3RB20 16-1PB0		1	1 unit	101	0.200
		1.1 ... 5.5	3 ... 12	35	▶ 3RB20 16-1SB0		1	1 unit	101	0.200
Size S0¹⁾										
	S0	1.1 ... 5.5	3 ... 12	35	▶ 3RB20 26-1SB0		1	1 unit	101	0.220
		3 ... 11	6 ... 25		▶ 3RB20 26-1QB0		1	1 unit	101	0.220
Size S2¹⁾³⁾⁷⁾										
	S2	3 ... 11	6 ... 25	35	▶ 3RB20 36-1QB0		1	1 unit	101	0.360
					▶ 3RB20 36-1QW1		1	1 unit	101	0.230
		7.5 ... 22	12.5 ... 50	100	▶ 3RB20 36-1UB0		1	1 unit	101	0.360
Size S3¹⁾³⁾⁷⁾										
	S3	7.5 ... 22	12.5 ... 50	125	▶ 3RB20 46-1UB0		1	1 unit	101	0.560
					▶ 3RB20 46-1EB0		1	1 unit	101	0.560
		11 ... 45	25 ... 100	200	▶ 3RB20 46-1EW1		1	1 unit	101	0.450
Size S6²⁾⁷⁾										
	S6	22 ... 90	50 ... 200	355	▶ 3RB20 56-1FC2		1	1 unit	101	1.030
					▶ 3RB20 56-1FW2		1	1 unit	101	0.690
Size S10/S12²⁾										
	S10/S12 and size 14 (3TF68/3TF69)	22 ... 110	55 ... 250	500	▶ 3RB20 66-1GC2		1	1 unit	101	1.820
		90 ... 450	160 ... 630	800	▶ 3RB20 66-1MC2		1	1 unit	101	1.820

- The relays with an Order No. ending with "0" are designed for direct mounting. With the matching terminal brackets (see Accessories) the sizes S00 and S0 can also be installed as stand-alone units.
- The relays with an Order No. ending with "2" are designed for direct mounting and stand-alone installation. For 3TF68/3TF69 contactors, direct mounting is not possible.
- The relays with an Order No. ending with "1" are designed for stand-alone installation.
- Observe maximum rated operational current of the devices.

- Standard value for 4-pole standard motors at 50 Hz 400 V AC. The actual starting and rated data of the motor to be protected must be considered when selecting the units.
- Maximum fuse for overload relay, type of coordination 2. For fuse values in conjunction with contactors, see Technical Specifications, Short-Circuit Protection with Fuses for Motor Feeders.
- The relays with an Order No. with "W" in penultimate position are equipped with a straight-through transformer.

Overload Relays







3RB2 Solid-State Overload Relays

3RB20, 3RB21 for standard applications

3RB20 solid-state overload relays with spring-loaded terminals on the auxiliary current side for direct mounting¹⁾²⁾ and stand-alone installation²⁾³⁾, CLASS 10

Features and technical specifications:

- Overload protection, phase failure protection and unbalance protection
- Internal power supply
- Auxiliary contacts 1 NO + 1 NC
- Manual and automatic RESET
- Switch position indicator
- TEST function and self-monitoring

Size Con-tactor ⁴⁾	Rating for induction motor Rated value ⁵⁾	Set current value of the inverse-time delayed overload trip	Short-circuit protection with fuse, type of coordination 2, gL/gG operational class ⁶⁾	DT	Order No.	Price per PU	PU (UNIT, SET, M)	PS*	PG	Weight per PU approx.	
	kW	A	A							kg	
Size S00¹⁾											
	S00	0.04 ... 0.09	0.1 ... 0.4	2	A	3RB20 16-1RD0		1	1 unit	101	0.200
		0.12 ... 0.37	0.32 ... 1.25	6	A	3RB20 16-1ND0		1	1 unit	101	0.200
		0.55 ... 1.5	1 ... 4	20	A	3RB20 16-1PD0		1	1 unit	101	0.200
		1.1 ... 5.5	3 ... 12	35	A	3RB20 16-1SD0		1	1 unit	101	0.200
Size S0¹⁾											
	S0	1.1 ... 5.5	3 ... 12	35	A	3RB20 26-1SD0		1	1 unit	101	0.220
		3 ... 11	6 ... 25		A	3RB20 26-1QD0		1	1 unit	101	0.220
Size S2¹⁾³⁾⁷⁾											
	S2	3 ... 11	6 ... 25	35	A	3RB20 36-1QD0		1	1 unit	101	0.360
					A	3RB20 36-1QX1		1	1 unit	101	0.230
		7.5 ... 22	12.5 ... 50	100	A	3RB20 36-1UD0		1	1 unit	101	0.360
					A	3RB20 36-1UX1		1	1 unit	101	0.230
Size S3¹⁾³⁾⁷⁾											
	S3	7.5 ... 22	12.5 ... 50	125	A	3RB20 46-1UD0		1	1 unit	101	0.560
		11 ... 45	25 ... 100	200	A	3RB20 46-1ED0		1	1 unit	101	0.560
					A	3RB20 46-1EX1		1	1 unit	101	0.450
Size S6²⁾⁷⁾											
	S6	22 ... 90	50 ... 200	355	A	3RB20 56-1FF2		1	1 unit	101	1.030
					A	3RB20 56-1FX2		1	1 unit	101	0.690
Size S10/S12²⁾											
	S10/S12 and size 14 (3TF68/3TF69)	22 ... 110	55 ... 250	500	A	3RB20 66-1GF2		1	1 unit	101	1.820
		90 ... 450	160 ... 630	800	A	3RB20 66-1MF2		1	1 unit	101	1.820

- 1) The relays with an Order No. ending with "0" are designed for direct mounting. With the matching terminal brackets (see Accessories) the sizes S00 and S0 can also be installed as stand-alone units.
- 2) The relays with an Order No. ending with "2" are designed for direct mounting and stand-alone installation. For 3TF68/3TF69 contactors, direct mounting is not possible.
- 3) The relays with an Order No. ending with "1" are designed for stand-alone installation.
- 4) Observe maximum rated operational current of the devices.

- 5) Standard value for 4-pole standard motors at 50 Hz 400 V AC. The actual starting and rated data of the motor to be protected must be considered when selecting the units.
- 6) Maximum fuse for overload relay, type of coordination 2. For fuse values in conjunction with contactors, see Technical Specifications, Short-Circuit Protection with Fuses for Motor Feeders.
- 7) The relays with an Order No. with "X" in penultimate position are equipped with a straight-through transformer.

* You can order this quantity or a multiple thereof.

Overload Relays

3RB2 Solid-State Overload Relays

3RB20, 3RB21 for standard applications

3RB20 solid-state overload relays with screw connection on auxiliary current side for direct mounting¹⁾²⁾ and stand-alone installation²⁾³⁾, CLASS 20

Features and technical specifications:

- Overload protection, phase failure protection and unbalance protection
- Internal power supply
- Auxiliary contacts 1 NO + 1 NC
- Manual and automatic RESET
- Switch position indicator
- TEST function and self-monitoring

Size Con- tactor ⁴⁾	Rating for induction motor Rated value ⁵⁾	Set current value of the inverse- time delayed overload trip	Short-circuit protection with fuse, type of coord- ination 2, gL/gG operational class ⁶⁾	DT	With screw connection on auxiliary current side		PU (UNIT, SET, M)	PS*	PG	Weight per PU approx.
					Order No.	Price per PU				
kW		A	A							
Size S00¹⁾										
S00	0.04 ... 0.09	0.1 ... 0.4	2	▶	3RB20 16-2RB0		1	1 unit	101	0.200
	0.12 ... 0.37	0.32 ... 1.25	6	▶	3RB20 16-2NB0		1	1 unit	101	0.200
	0.55 ... 1.5	1 ... 4	20	▶	3RB20 16-2PB0		1	1 unit	101	0.200
	1.1 ... 5.5	3 ... 12	35	▶	3RB20 16-2SB0		1	1 unit	101	0.200
3RB20 16-2RB0										
Size S0¹⁾										
S0	1.1 ... 5.5	3 ... 12	35	▶	3RB20 26-2SB0		1	1 unit	101	0.220
	3 ... 11	6 ... 25		▶	3RB20 26-2QB0		1	1 unit	101	0.220
3RB20 26-2QB0										
Size S2¹⁾³⁾⁷⁾										
S2	3 ... 11	6 ... 25	35	▶	3RB20 36-2QB0		1	1 unit	101	0.360
				▶	3RB20 36-2QW1		1	1 unit	101	0.230
	7.5 ... 22	12.5 ... 50	100	▶	3RB20 36-2UB0		1	1 unit	101	0.360
				▶	3RB20 36-2UW1		1	1 unit	101	0.230
3RB20 36-2UB0										
Size S3¹⁾³⁾⁷⁾										
S3	7.5 ... 22	12.5 ... 50	125	▶	3RB20 46-2UB0		1	1 unit	101	0.560
	11 ... 45	25 ... 100	200	▶	3RB20 46-2EB0		1	1 unit	101	0.560
				▶	3RB20 46-2EW1		1	1 unit	101	0.450
3RB20 46-2EB0										
Size S6²⁾⁷⁾										
S6	22 ... 90	50 ... 200	355	▶	3RB20 56-2FC2		1	1 unit	101	1.030
				▶	3RB20 56-2FW2		1	1 unit	101	0.690
3RB20 56-2FW2										
Size S10/S12²⁾										
S10/S12 and size 14 (3TF68/ 3TF69)	22 ... 110	55 ... 250	500	▶						

3RB20 66-2MC2

- 1) The relays with an Order No. ending with "0" are designed for direct mounting. With the matching terminal brackets (see Accessories) the sizes S00 and S0 can also be installed as stand-alone units.
- 2) The relays with an Order No. ending with "2" are designed for direct mounting and stand-alone installation. For 3TF68/3TF69 contactors, direct mounting is not possible.
- 3) The relays with an Order No. ending with "1" are designed for stand-alone installation.
- 4) Observe maximum rated operational current of the devices.
- 5) Standard value for 4-pole standard motors at 50 Hz 400 V AC. The actual starting and rated data of the motor to be protected must be considered when selecting the units.
- 6) Maximum fuse for overload relay, type of coordination 2. For fuse values in conjunction with contactors, see Technical Specifications, Short-Circuit Protection with Fuses for Motor Feeders.
- 7) The relays with an Order No. with "W" in penultimate position are equipped with a straight-through transformer.

Overload Relays

3RB2 Solid-State Overload Relays

3RB20, 3RB21 for standard applications

3RB20 solid-state overload relays with spring-loaded terminals on the auxiliary current side for direct mounting¹⁾²⁾ and stand-alone installation²⁾³⁾, CLASS 20

Features and technical specifications:

- Overload protection, phase failure protection and unbalance protection
- Internal power supply
- Auxiliary contacts 1 NO + 1 NC
- Manual and automatic RESET
- Switch position indicator
- TEST function and self-monitoring

Size Con- tactor ⁴⁾	Rating for induction motor Rated value ⁵⁾	Set current value of the inverse- time delayed overload trip	Short-circuit protection with fuse, type of coord- ination 2, gL/gG operational class ⁶⁾	DT	With spring-loaded terminals on auxiliary current side		PU (UNIT, SET, M)	PS*	PG	Weight per PU approx.
					Order No.	Price per PU				
Size S00¹⁾										
S00	0.04 ... 0.09	0.1 ... 0.4	2	A	3RB20 16-2RD0		1	1 unit	101	0.200
	0.12 ... 0.37	0.32 ... 1.25	6	A	3RB20 16-2ND0		1	1 unit	101	0.200
	0.55 ... 1.5	1 ... 4	20	A	3RB20 16-2PD0		1	1 unit	101	0.200
	1.1 ... 5.5	3 ... 12	35	A	3RB20 16-2SD0		1	1 unit	101	0.200
3RB20 16-2RD0										
Size S0¹⁾										
S0	1.1 ... 5.5	3 ... 12	35	A	3RB20 26-2SD0		1	1 unit	101	0.220
	3 ... 11	6 ... 25		A	3RB20 26-2QD0		1	1 unit	101	0.220
3RB20 26-2QD0										
Size S2¹⁾³⁾⁷⁾										
S2	3 ... 11	6 ... 25	35	A	3RB20 36-2QX1		1	1 unit	101	0.230
				A	3RB20 36-2QD0		1	1 unit	101	0.360
	7.5 ... 22	12.5 ... 50	100	A	3RB20 36-2UD0		1	1 unit	101	0.360
				A	3RB20 36-2UX1		1	1 unit	101	0.230
3RB20 36-2UD0										
Size S3¹⁾³⁾⁷⁾										
S3	7.5 ... 22	12.5 ... 50	125	A	3RB20 46-2UD0		1	1 unit	101	0.560
				A	3RB20 46-2ED0		1	1 unit	101	0.560
	11 ... 45	25 ... 100	200	A	3RB20 46-2EX1		1	1 unit	101	0.450
3RB20 46-2ED0										
Size S6²⁾⁷⁾										
S6	22 ... 90	50 ... 200	355	A	3RB20 56-2FF2		1	1 unit	101	1.030
				A	3RB20 56-2FX2		1	1 unit	101	0.690
3RB20 56-2FX2										
Size S10/S12²⁾										

1) The relays with an Order No. ending with "0" are designed for direct mounting. With the matching terminal brackets (see Accessories) the sizes S00 and S0 can also be installed as stand-alone units.

2) The relays with an Order No. ending with "2" are designed for direct mounting and stand-alone installation. For 3TF68/3TF69 contactors, direct mounting is not possible.

3) The relays with an Order No. ending with "1" are designed for stand-alone installation.

4) Observe maximum rated operational current of the devices.

5) Standard value for 4-pole standard motors at 50 Hz 400 V AC. The actual starting and rated data of the motor to be protected must be considered when selecting the units.

6) Maximum fuse for overload relay, type of coordination 2. For fuse values in conjunction with contactors, see Technical Specifications, Short-Circuit Protection with Fuses for Motor Feeders.

7) The relays with an Order No. with "X" in penultimate position are equipped with a straight-through transformer.

Overload Relays

3RB2 Solid-State Overload Relays

3RB20, 3RB21 for standard applications

3RB21 solid-state overload relays with screw connection on auxiliary current side for direct mounting¹⁾²⁾ and stand-alone installation²⁾³⁾, CLASS 5, 10, 20 and 30 adjustable

Features and technical specifications:

- Overload protection, phase failure protection and unbalance protection
- Internal ground fault detection (activatable)
- Internal power supply
- Auxiliary contacts 1 NO + 1 NC
- Manual and automatic RESET
- Electrical remote RESET integrated
- Switch position indicator
- TEST function and self-monitoring

Size Con-tactor ⁴⁾	Rating for induction motor Rated value ⁵⁾	Set current value of the inverse-time delayed overload trip	Short-circuit protection with fuse, type of coordination 2, gL/gG operational class ⁶⁾	DT	With screw connection on auxiliary current side		PU (UNIT, SET, M)	PS*	PG	Weight per PU approx.
					Order No.	Price per PU				
	kW	A	A							kg
Size S00¹⁾										
S00	0.04 ... 0.09	0.1 ... 0.4	2	▶	3RB21 13-4RB0		1	1 unit	101	0.200
	0.12 ... 0.37	0.32 ... 1.25	6	▶	3RB21 13-4NB0		1	1 unit	101	0.200
	0.55 ... 1.5	1 ... 4	20	▶	3RB21 13-4PB0		1	1 unit	101	0.200
	1.1 ... 5.5	3 ... 12	35	▶	3RB21 13-4SB0		1	1 unit	101	0.200
3RB21 13-4RB0										
Size S0¹⁾										
S0	1.1 ... 5.5	3 ... 12	35	▶	3RB21 23-4SB0		1	1 unit	101	0.220
	3 ... 11	6 ... 25		▶	3RB21 23-4QB0		1	1 unit	101	0.220
3RB21 23-4QB0										
Size S2¹⁾³⁾⁷⁾										
S2	3 ... 11	6 ... 25	35	▶	3RB21 33-4QB0		1	1 unit	101	0.360
				▶	3RB21 33-4QW1		1	1 unit	101	0.230
	7.5 ... 22	12.5 ... 50	100	▶	3RB21 33-4UB0		1	1 unit	101	0.360
				▶	3RB21 33-4UW1		1	1 unit	101	0.230
3RB21 33-4UB0										
Size S3¹⁾³⁾⁷⁾										
S3	7.5 ... 22	12.5 ... 50	125	▶	3RB21 43-4UB0		1	1 unit	101	0.560
				▶	3RB21 43-4EB0		1	1 unit	101	0.560
	11 ... 45	25 ... 100	200	▶	3RB21 43-4EW1		1	1 unit	101	0.450
3RB21 43-4EB0										
Size S6²⁾⁷⁾										
S6	22 ... 90	50 ... 200	355	▶	3RB21 53-4FC2		1	1 unit	101	1.030
				▶	3RB21 53-4FW2		1	1 unit	101	0.690
3RB21 53-4FC2										
Size S10/S12²⁾										
S10/S12 and size 14 (3TF68/3TF69)	22 ... 110	55 ... 250	500	▶	3RB21 63-4GC2		1	1 unit	101	1.820
	90 ... 450	160 ... 630	500 800							

3RB21 63-4MC2

- 1) The relays with an Order No. ending with "0" are designed for direct mounting. With the matching terminal brackets (see Accessories) the sizes S00 and S0 can also be installed as stand-alone units.
- 2) The relays with an Order No. ending with "2" are designed for direct mounting and stand-alone installation. For 3TF68/3TF69 contactors, direct mounting is not possible.
- 3) The relays with an Order No. ending with "1" are designed for stand-alone installation.
- 4) Observe maximum rated operational current of the devices.
- 5) Standard value for 4-pole standard motors at 50 Hz 400 V AC. The actual starting and rated data of the motor to be protected must be considered when selecting the units.
- 6) Maximum fuse for overload relay, type of coordination 2. For fuse values in conjunction with contactors, see Technical Specifications, Short-Circuit Protection with Fuses for Motor Feeders.
- 7) The relays with an Order No. with "W" in penultimate position are equipped with a straight-through transformer.

Overload Relays







3RB2 Solid-State Overload Relays

3RB20, 3RB21 for standard applications

3RB21 solid-state overload relays with spring-loaded terminals on the auxiliary current side for direct mounting¹⁾²⁾ and stand-alone installation¹⁾³⁾, CLASS 5, 10, 20 and 30 adjustable

Features and technical specifications:

- Overload protection, phase failure protection and unbalance protection
- Internal ground fault detection (activatable)
- Internal power supply
- Auxiliary contacts 1 NO + 1 NC
- Manual and automatic RESET
- Electrical remote RESET integrated
- Switch position indicator
- TEST function and self-monitoring

Size Contactor ⁴⁾	Rating for induction motor Rated value ⁵⁾	Set current value of the inverse-time delayed overload trip	Short-circuit protection with fuse, type of coordination 2, gL/gG operational class ⁶⁾	DT	With spring-loaded terminals on auxiliary current side		PU (UNIT, SET, M)	PS*	PG	Weight per PU approx.	
					Order No.	Price per PU					
	kW	A	A							kg	
Size S00¹⁾											
	S00	0.04 ... 0.09	0.1 ... 0.4	2	A	3RB21 13-4RD0		1	1 unit	101	0.200
		0.12 ... 0.37	0.32 ... 1.25	6	A	3RB21 13-4ND0		1	1 unit	101	0.200
		0.55 ... 1.5	1 ... 4	20	A	3RB21 13-4PD0		1	1 unit	101	0.200
		1.1 ... 5.5	3 ... 12	35	A	3RB21 13-4SD0		1	1 unit	101	0.200
Size S0¹⁾											
	S0	1.1 ... 5.5	3 ... 12	35	A	3RB21 23-4SD0		1	1 unit	101	0.220
		3 ... 11	6 ... 25		A	3RB21 23-4QD0		1	1 unit	101	0.220
Size S2¹⁾³⁾⁷⁾											
	S2	3 ... 11	6 ... 25	35	A	3RB21 33-4QD0		1	1 unit	101	0.360
					A	3RB21 33-4QX1		1	1 unit	101	0.230
		7.5 ... 22	12.5 ... 50	100	A	3RB21 33-4UD0		1	1 unit	101	0.360
					A	3RB21 33-4UX1		1	1 unit	101	0.230
Size S3¹⁾³⁾⁷⁾											
	S3	7.5 ... 22	12.5 ... 50	125	A	3RB21 43-4UD0		1	1 unit	101	0.560
		11 ... 45	25 ... 100	200	A	3RB21 43-4ED0		1	1 unit	101	0.560
					A	3RB21 43-4EX1		1	1 unit	101	0.450
Size S6²⁾⁷⁾											
	S6	22 ... 90	50 ... 200	355	A	3RB21 53-4FF2		1	1 unit	101	1.030
					A	3RB21 53-4FX2		1	1 unit	101	0.690
Size S10/S12²⁾											
	S10/S12 and size 14 (3TF68/3TF69)	22 ... 110	55 ... 250	500	A	3RB21 63-4GF2		1	1 unit	101	1.820
		90 ... 450	160 ... 630	800	A	3RB21 63-4MF2		1	1 unit	101	1.820

- 1) The relays with an Order No. ending with "0" are designed for direct mounting. With the matching terminal brackets (see Accessories) the sizes S00 and S0 can also be installed as stand-alone units.
- 2) The relays with an Order No. ending with "2" are designed for direct mounting and stand-alone installation. For 3TF68/3TF69 contactors, direct mounting is not possible.
- 3) The relays with an Order No. ending with "1" are designed for stand-alone installation.
- 4) Observe maximum rated operational current of the devices.

- 5) Standard value for 4-pole standard motors at 50 Hz 400 V AC. The actual starting and rated data of the motor to be protected must be considered when selecting the units.
- 6) Maximum fuse for overload relay, type of coordination 2. For fuse values in conjunction with contactors, see Technical Specifications, Short-Circuit Protection with Fuses for Motor Feeders.
- 7) The relays with an Order No. with "X" in penultimate position are equipped with a straight-through transformer.

* You can order this quantity or a multiple thereof.

Overload Relays

3RB2 Solid-State Overload Relays

3RB22, 3RB23 for high-feature applications

Overview

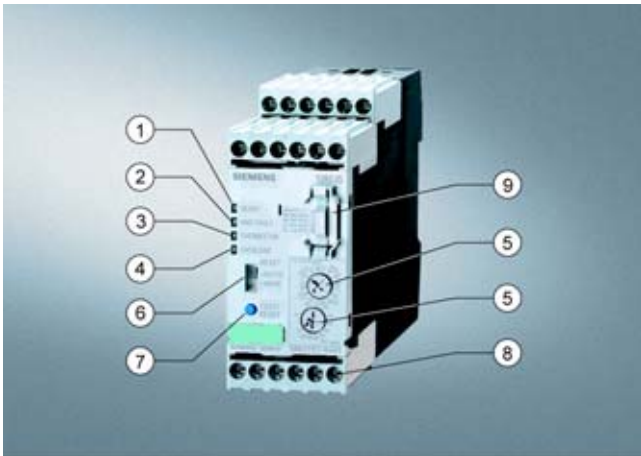

3RB22/3RB23 evaluation module

- (1) Green "Ready" LED
A continuous green light signals that the device is working correctly.
- (2) Red "Ground fault" LED:
A continuous red light signals a ground fault.
- (3) Red "Thermistor" LED:
A continuous red light signals an active thermistor trip.
- (4) Red "Overload" LED:
A continuous red light signals an active overload trip; a flickering red light signals an imminent trip (overload warning).
- (5) Motor current and trip class adjustment:
Setting the device to the motor current and to the required trip class dependent on the starting conditions is easy with the two rotary knobs.
- (6) Selector switch for manual/automatic RESET:
With this switch you can choose between manual and automatic RESET.
- (7) Test/RESET button:
Enables testing of all important device components and functions, plus resetting of the device after a trip when manual RESET is selected.
- (8) Connecting terminals (removable terminal block):
The generously sized terminals permit connection of two conductors with different cross-sections for the auxiliary, control and sensor circuits. Connection is possible with screw-type terminals and alternatively with spring-loaded terminals.
- (9) 3RB29 85 function expansion module:
Enables more functions to be added, e.g. internal ground fault detection and/or an analog output with corresponding signals.



3RB29 06 current measuring module

The modular, solid-state overload relays with external power supply type 3RB22 (with monostable auxiliary contacts) and type 3RB23 (with bistable auxiliary contacts) up to 630 A (up to 820 A possible with a series transformer) have been designed for inverse-time delayed protection of loads with normal and heavy starting (see LV 1 T, Function) against excessive temperature rises due to overload, phase unbalance or phase failure. An overload, phase unbalance or phase failure result in an increase of the motor current beyond the set motor rated current. This current rise is detected by means of a current measuring module and electronically evaluated by a special evaluation module which is connected to it. The evaluation electronics sends a signal to the auxiliary contacts. The auxiliary contacts then switch off the load by means of a contactor. The break time depends on the ratio between the tripping current and set current I_g and is stored in the form of a long-term stable tripping characteristic (see LV 1 T, Characteristic Curves). The "tripped" status is signaled by means of a continuous red "Overload" LED.

The LED indicates imminent tripping of the relay due to overload, phase unbalance or phase failure by flickering when the limit current has been violated. This warning can also be issued as a signal through auxiliary contacts.

In addition to the described inverse-time delayed protection of loads against excessive temperature rises, the 3RB22/3RB23 solid-state overload relays also allow direct temperature monitoring of the motor windings (full motor protection) by failsafe connection of a PTC sensor circuit. With this temperature-dependent protection, the loads can be protected against overheating caused indirectly by reduced coolant flow, for example, which cannot be detected by means of the current alone. In the event of overheating, the devices switch off the contactor, and thus the load, by means of the auxiliary contacts. The "tripped" status is signaled by means of a continuously illuminated "Overload" LED.

To also protect the loads against high-resistance short-circuits due to damage to the insulation, humidity, condensed water, etc., the 3RB22/3RB23 solid-state overload relays offer the possibility of internal ground fault monitoring in conjunction with a function expansion module (for details see Selection and Ordering Data; not possible in conjunction with contactor assembly for Wye-Delta starting). In the event of a ground fault the 3RB22/3RB23 relays trip instantaneously. The "tripped" status is signaled by means of a red "Ground Fault" LED. Signaling through auxiliary contacts is also possible.

After tripping due to overload, phase unbalance, phase failure, thermistor tripping or ground fault, the relay is reset manually or automatically after the recovery time has elapsed (see LV 1 T, Function).

In conjunction with a function expansion module the motor current measured by the microprocessor can be output in the form of an analog signal 4 ... 20 mA DC for operating rotary coil instruments or for feeding into analog inputs of programmable logic controllers. With an additional AS-Interface analog module the current values can also be transferred over the AS-i bus system.

The devices are manufactured in accordance with environmental guidelines and contain environmentally friendly and reusable materials.

They comply with all important worldwide standards and approvals.

Overload Relays

3RB2 Solid-State Overload Relays

3RB22, 3RB23 for high-feature applications

Benefits

The most important features and benefits of the 3RB22/3RB23 solid-state overload relays are listed in the overview table (see [Overload Relays, General Data](#)).

Application

Industries

The 3RB22/3RB23 solid-state overload relays are suitable for customers from all industries who want to guarantee optimum inverse-time delayed and temperature-dependent protection of their electrical loads (e.g. motors) under normal and heavy starting conditions (CLASS 5 to CLASS 30), minimize project completion times, inventories and power consumption, and optimize plant availability and maintenance management.

Application

The 3RB22/3RB23 solid-state overload relays have been designed for the protection of three-phase asynchronous and single-phase AC motors.

If single-phase AC motors are to be protected by the 3RB22/3RB23 solid-state overload relays, the main circuits of the currents of the

sc-g -120010 -1.7165 TD-0.0
c.3(3(ng)5.eors.))TJ0 -1.6525 Tc-0.0015 TwF(e)6.o(u)-0.r(r)-7.1(t)5.5(h1(t)5.e(u)-0.m 2(e)6.1(r)-3.1(a)9.1(t)-6(cu)6.9(r)12 r(3(ng)2.5(e)-7. of)5.0

leha(ed)5. 3o 7. 1(a)-7. o11. 9(e)-7. 1lay(" ty1(p)5. e(o)-0. 1(-)-7. 1(p)5. f)3 pr7pei tprlng 2d

T h (

Overload Relays

3RB2 Solid-State Overload Relays

3RB22, 3RB23 for high-feature applications

Selection and ordering data

Conversion aid 3RB12 → 3RB22/3RB23

Size	Old Order No. Complete unit	Setting range A	New Order No. Current measuring module	Setting range A	New Order No. Evaluation module	New Order No. Function expansion module
S00/S0	3RB12 46-1P □□□	1.25 ... 6.3	3RB29 06-2BG1	0.3 ... 3		
	3RB12 46-1Q □□□	6.3 ... 25	3RB29 06-2DG1	2.4 ... 25		
S2/S3	3RB12 46-1E □□□	25 ... 100	3RB29 06-2JG1	10 ... 100	3RB2 □ 83-4AA1	3RB29 85-2 □□□
S6	3RB12 53-1F □□□	50 ... 205	3RB29 56-2TG2	20 ... 200		
			3RB29 56-2TH2			
S10/S12	3RB12 57-0K □□□	125 ... 500	3RB29 66-2WH2	63 ... 630 (820)		
	3RB12 62-0L □□□	200 ... 820				

	G	M	B			
110 ... 120 V AC					Integrated	Integrated
220 ... 240 V AC					Integrated	Integrated
24 V DC					Integrated	Integrated
Standard design with ground fault signal		00			Not available	--
Standard design with overload warning		10			2	Not required
Version with internal ground fault detection and ground fault signal		20			2	CB1
Version with internal ground fault detection and overload warning		30			2	CA1
Version with analog output		40			2	AA0
Bistable version with ground fault signal		01			Not available	--
Bistable version with overload warning		11			3	Not required

5

Overload Relays



3RB2 Solid-State Overload Relays

3RB22, 3RB23 for high-feature applications

3RB22/3RB23 solid-state overload relays for full motor protection with screw connection or spring-loaded terminals for stand-alone installation, CLASS 5, 10, 20 and 30 adjustable

Features and technical specifications:

- Overload protection, phase failure protection and unbalance protection
- External power supply 24 ... 240 V AC/DC
- Auxiliary contacts 2 NO +2 NC
- Manual and automatic RESET
- Electrical remote RESET integrated
- 4 LEDs for operating and status displays
- TEST function and self-monitoring
- Internal ground fault detection with function expansion module
- Screw connection or spring-loaded terminals for auxiliary, control and sensor circuits
- Input for PTC sensor circuit
- Analog output with function expansion module

Size Contactor	Version	Connection type	DT	Order No.	Price per PU	PU (UNIT, SET, M)	PS*	PG	Weight per PU approx. kg
Evaluation modules									
 3RB2. 83-4AA1	S00 ... S12 Monostable	Screw connection	▶	3RB22 83-4AA1		1	1 unit	101	0.300
		Spring-loaded terminals	A	3RB22 83-4AC1		1	1 unit	101	0.300
	Bistable	Screw connection	▶	3RB23 83-4AA1		1	1 unit	101	0.300
		Spring-loaded terminals	A	3RB23 83-4AC1		1	1 unit	101	0.300
 3RB2. 83-4AC1									
Function expansion modules									
–	Analog Basic 1 module¹⁾ Analog output DC 4 ... 20 mA, with overload warning	▶	3RB29 85-2AA0		1	1 unit	101	0.030	
	Analog Basic 1 GF module¹⁾²⁾ Analog output DC 4 ... 20 mA, with internal ground fault detection and overload warning	▶	3RB29 85-2AA1		1	1 unit	101	0.030	
	Analog Basic 2 GF module¹⁾²⁾ Analog output DC 4 ... 20 mA, with internal ground fault detection and ground fault signaling	▶	3RB29 85-2AB1		1	1 unit	101	0.030	
	Basic 1 GF module²⁾ with internal ground fault detection and overload warning	▶	3RB29 85-2CA1		1	1 unit	101	0.030	
	Basic 2 GF module²⁾ with internal ground fault detection and ground fault signaling	▶	3RB29 85-2CB1		1	1 unit	101	0.030	

1) The analog signal 4 ... 20 mA DC can be used for operating rotary coil instruments or for feeding into analog inputs of programmable logic controllers.

2) The following information on ground fault protection refers to sinusoidal residual currents at 50/60 Hz:





- With a motor current of between 0.3 and 2 times the set current I_e the unit will trip at a ground fault current equal to 30% of the set current.
- With a motor current of between 2 and 8 times the set current I_e the unit will trip at a ground fault current equal to 15% of the set current.
- The trip delay amounts to between 0.5 and 1 second.

Overload Relays

3RB2 Solid-State Overload Relays

3RB22, 3RB23 for high-feature applications

Current measuring modules for direct mounting¹⁾ and stand-alone installation¹⁾²⁾

Size Contactor ³⁾	Rating for induction motor, Rated value ⁴⁾	Set current value of the inverse-time delayed overload trip	Short-circuit protection with fuse, type of coordination 2, gL/gG operational class ⁵⁾	DT	Order No.	Price per PU	PU (UNIT, SET, M)	PS*	PG	Weight per PU approx.
	kW	A	A							kg
Size S00/S0²⁾⁶⁾										
	S00/S0	0.09 ... 1.1	0.3 ... 3	16	▶ 3RB29 06-2BG1		1	1 unit	101	0.100
		1.1 ... 11	2.4 ... 25	63	▶ 3RB29 06-2DG1		1	1 unit	101	0.150
Size S2/S3²⁾⁶⁾										
	S2/S3	5.5 ... 45	10 ... 100	250	▶ 3RB29 06-2JG1		1	1 unit	101	0.350
Size S6¹⁾⁶⁾										
	S6	11 ... 90	20 ... 200	355	▶ 3RB29 56-2TG2		1	1 unit	101	0.600
					▶ 3RB29 56-2TH2		1	1 unit	101	1.000
Size S10/S12¹⁾										
	S10/S12 and size 14 (3TF68/3TF69)	37 ... 450	63 ... 630	630	▶ 3RB29 66-2WH2		1	1 unit	101	1.750

- 1) The current measuring modules with an Order No. ending with "2" are designed for direct mounting and stand-alone installation. For 3TF68/3TF69 contactors, direct mounting is not possible.
- 2) The current measuring modules with an Order No. ending with "1" are designed for stand-alone installation.
- 3) Observe maximum rated operational current of the devices.

- 4) Standard value for 4-pole standard motors at 50 Hz 400 V AC. The actual starting and rated data of the motor to be protected must be considered when selecting the units.
- 5) Maximum fuse for overload relay, type of coordination 2. For fuse values in conjunction with contactors, see Technical Specifications, Short-Circuit Protection with Fuses for Motor Feeders.
- 6) The modules with an Order No. with "G" in penultimate position are equipped with a straight-through transformer.

Size Contactor	Version	DT	Order No.	Price per PU	PU (UNIT, SET, M)	PS*	PG	Weight per PU approx.
----------------	---------	----	-----------	--------------	-------------------	-----	----	-----------------------

Connecting leads									
	S00 ... S12	For connection between evaluation module and current measuring module							
		<ul style="list-style-type: none"> • Length 0.1 m • Length 0.5 m 	▶ 3RB29 87-2B		1	1 unit	101	0.010	
			▶ 3RB29 87-2D		1	1 unit	101	0.020	

Overload Relays

3RB2 Solid-State Overload Relays

Accessories

Overview

Overload relays for standard applications

The following accessories are available for the 3RB20/3RB21 solid-state overload relays:



- One terminal bracket each for the overload relays size S00 and S0 (sizes S2 to S12 can be installed as single units without a terminal bracket)
- One mechanical RESET module for all sizes
- One cable release for resetting devices which are difficult to access (for all sizes)
- One sealable cover for all sizes
- Box terminal blocks for sizes S6 and S10/S12
- Terminal covers for sizes S2 to S10/S12

Overload relays for high-feature applications

The following accessories are available for the 3RB22/3RB23 solid-state overload relays:

- A sealable cover for the evaluation module
- Box terminal blocks for the current measuring modules size S6 and S10/S12
- Terminal covers for the current measuring modules size S6 and S10/S12
- Push-in lugs for screw mounting the size S00 to S3 current measuring modules

Selection and ordering data

Version	Size	DT	Order No.	Price per PU	PU (UNIT, SET, M)	PS*	PG	Weight per PU approx. kg	
Terminal brackets for stand-alone installation¹⁾									
 3RB29 .3-0AA1	For separate mounting of the overload relays; screw and snap-on mounting onto TH35 standard mounting rail	S00	A	3RB29 13-0AA1		1	1 unit	101	0.060
		S0	A	3RB29 23-0AA1		1	1 unit	101	0.080
Mechanical RESET²⁾									
 3RU19 00-1A with pushbutton and extension plunger	Resetting plungers, holders and formers	S00 ... S10/S12	▶	3RU19 00-1A		1	1 set	101	0.038
	Pushbuttons with extended stroke (12 mm), IP65, Ø 22 mm		B	3SB30 00-0EA11		1	1 unit	102	0.021
	Extension plungers For compensation of the distance between a pushbutton and the unlatching button of the relay		A	3SX1 335		1	1 unit	102	0.004
Cable releases with holder for RESET²⁾									
 3RU19 00-1.	For holes with Ø 6.5 mm in the mounting plate; max. control panel thickness 8 mm	S00 ... S10/S12							
	<ul style="list-style-type: none"> • Length 400 mm • Length 600 mm 		▶	3RU19 00-1B		1	1 unit	101	0.063
			▶	3RU19 00-1C		1	1 unit	101	0.073





1) Only for 3RB20/3RB21.

2) Only for 3RB20/3RB21. The accessories are identical to those of the 3RU11 thermal overload relays.

Overload Relays

3RB2 Solid-State Overload Relays

Accessories

Version	Size	DT	Order No.	Price per PU	PU (UNIT, SET, M)	PS*	PG	Weight per PU approx. kg
Sealable covers								
For covering the setting knobs								
	• For 3RB20/3RB21	S00 ... S10/S12	▶ 3RB29 84-0		1	10 units	101	0.020
	• For 3RB22/3RB23	–	▶ 3RB29 84-2		1	10 units	101	0.050
Terminal covers								
Covers for cable lugs and rail connection								
	• Length 55 mm ¹⁾	S3	▶ 3RT19 46-4EA1		1	1 unit	101	0.037
	• Length 100 mm	S6	▶ 3RT19 56-4EA1		1	1 unit	101	0.067
	• Length 120 mm	S10/S12	▶ 3RT19 66-4EA1		1	1 unit	101	0.124
Covers for box terminals								
	• Length 20.6 mm ¹⁾	S2	▶ 3RT19 36-4EA2		1	1 unit	101	0.016
	• Length 20.8 mm ¹⁾	S3	▶ 3RT19 46-4EA2		1	1 unit	101	0.023
	• Length 25 mm	S6	▶ 3RT19 56-4EA2		1	1 unit	101	0.028
	• Length 30 mm	S10/S12	▶ 3RT19 66-4EA2		1	1 unit	101	0.038
Covers for screw connections								
between contactor and overload relay, without box terminals (1 unit required per combination)								
	S6	▶ 3RT19 56-4EA3			1	1 unit	101	0.021
	S10/S12	▶ 3RT19 66-4EA3			1	1 unit	101	0.062
Box terminal blocks								
	For round and ribbon cables up to 70 mm ²	S6 ²⁾	▶ 3RT19 55-4G		1	1 unit	101	0.237
	up to 120mm ²	S6	▶ 3RT19 56-4G		1	1 unit	101	0.270
	up to 240mm ²	S10/S12	▶ 3RT19 66-4G		1	1 unit	101	0.676
For conductor cross-sections, see LV 1 T "Technical Specifications"								
Push-in lugs								
	For screw mounting of 3RB29 06 current measuring modules (2 units are required per module)	S00 ... S3	▶ 3RB19 00-0B		100	10 units	101	0.100

For more accessories (tools for spring-loaded terminals and labeling plates), see page 5/56.

1) Only for 3RB20/3RB21. The accessories are identical to those of the 3RU11 thermal overload relays.

2) In the scope of supply for 3RT10 54-1 contactors (55 kW).

Overload Relays

3RU1 Thermal Overload Relays

3RU11 for standard applications

Overview



- (1) Connection for mounting onto contactors:
Optimally adapted in electrical, mechanical and design terms to the contactors, these connecting pins can be used for direct mounting of the overload relays. Stand-alone installation is possible as an alternative (in some cases in conjunction with a stand-alone installation module).
- (2) Selector switch for manual/automatic RESET and RESET button:
With this switch you can choose between manual and automatic RESET. A device set to manual RESET can be reset locally by pressing the RESET button. A remote RESET is possible using the RESET modules (accessories), which are independent of size.
- (3) Switch position indicator and TEST function of the wiring:
Indicates a trip and enables the wiring test.
- (4) Motor current setting:
Setting the device to the rated motor current is easy with the large rotary knob.
- (5) STOP button:
If the STOP button is pressed, the NC contact is opened. This switches off the contactor downstream. The contactor is switched on again when the STOP button is released.
- (6) Transparent, sealable cover:
Secures the motor current setting, TEST function and the selector switch for manual/automatic RESET against adjustment.
- (7) Supply terminals:
The generously sized terminals permit connection of two conductors with different cross-sections for the main and auxiliary circuits. The auxiliary circuit can be connected with screw-type terminals and alternatively with spring-loaded terminals.

The 3RU11 thermal overload relays up to 100 A have been designed for current-dependent protection of loads with normal starting (see LV 1 T, Function) against excessive temperature rises due to overload or phase failure. An overload or phase failure results in an increase of the motor current beyond the set motor rated current. Via heating elements, this current rise heats up the bimetal strips inside the device, which then bend and as a result trigger the auxiliary contacts by means of a tripping mechanism. The auxiliary contacts then switch off the load by means of a contactor. The break time depends on the ratio between the tripping current and set current I_{θ} and is stored in the form of a long-term stable tripping characteristic (see LV 1 T, Characteristic Curves).

The "tripped" status is signaled by means of a switch position indicator (see LV 1 T, Function). Resetting takes place either manually or automatically after the recovery time has elapsed (see LV 1 T, Function).

The devices are manufactured in accordance with environmental guidelines and contain environmentally friendly and reusable materials.

They comply with all important worldwide standards and approvals.

Benefits

The most important features and benefits of the 3RU11 thermal overload relays are listed in the overview table (see Overload Relays, General Data).

Application

Industries

The 3RU11 thermal overload relays are suitable for customers from all industries who want to guarantee optimum inverse-time delayed protection of their electrical loads (e.g. motors) under normal starting conditions (CLASS 10).

Application

The 3RU11 thermal overload relays have been designed for the protection of three-phase and single-phase AC and DC motors.

If single-phase AC or DC loads are to be protected by the 3RU11 thermal overload relays, all three bimetal strips must be heated. For this purpose, all main circuits of the relay must be connected in series.

Ambient conditions

The 3RU11 thermal overload relays have temperature compensation in accordance with IEC 60947-4-1 for the temperature range of -20 to $+60$ °C. For temperatures from $+60$ to $+80$ °C the upper setpoint value of the setting range must be reduced by the factor listed in the table below.

Ambient temperature in °C	Derating factor for the upper setpoint value
+60	1.0
+65	0.94
+70	0.87
+75	0.81
+80	0.73

"Increased safety" type of protection EEx e according to ATEX guideline 94/9/EC

The 3RU11 thermal overload relays are suitable for the overload protection of explosion-proof motors with "increased safety" type of protection EEx e. The relays meet the requirements of EN 60079-7 (Electrical apparatus for potentially explosive atmospheres – Increased safety "e").

The basic safety and health requirements of ATEX guideline 94/9/EG are fulfilled by compliance with

- EN 60947-4-1
- EN 60947-5-1
- EN 60079-14: 1997-02
- EN 60079-17: 1996-12

EU type test certificate for Category (2) G/D exists. It has the number DMT 98 ATEX 6001.

Overload Relays

3RU1 Thermal Overload Relays





3RU11 for standard applications

Selection and ordering data

3RU11 thermal overload relays with screw connection on the auxiliary current side for direct mounting¹⁾, CLASS 10

Features and technical specifications:

- Overload and phase failure protection
- Auxiliary contacts 1 NO + 1 NC
- Manual and automatic RESET
- Switch position indicator
- TEST function
- STOP button
- Integrated, sealable cover

Size Con- tactor ²⁾	Rating for induction motor, Rated value ³⁾	Set current value of the inverse- time delayed overload trip	Short-circuit protection with fuse, type of coordi- nation 2, gL/gG operational class ⁴⁾	DT	Order No.	Price per PU	PU (UNIT, SET, M)	PS*	PG	Weight per PU approx.	
	kW	A	A							kg	
Size S00											
	S00	0.04	0.11 ... 0.16	0.5	A	3RU11 16-0AB0		1	1 unit	101	0.150
		0.06	0.14 ... 0.2	1	A	3RU11 16-0BB0		1	1 unit	101	0.150
		0.06	0.18 ... 0.25	1	▶	3RU11 16-0CB0		1	1 unit	101	0.150
		0.09	0.22 ... 0.32	1.6	▶	3RU11 16-0DB0		1	1 unit	101	0.150
		0.09	0.28 ... 0.4	2	▶	3RU11 16-0EB0		1	1 unit	101	0.150
		0.12	0.35 ... 0.5	2	▶	3RU11 16-0FB0		1	1 unit	101	0.150
		0.18	0.45 ... 0.63	2	▶	3RU11 16-0GB0		1	1 unit	101	0.150
		0.18	0.55 ... 0.8	4	▶	3RU11 16-0HB0		1	1 unit	101	0.150
		0.25	0.7 ... 1	4	▶	3RU11 16-0JB0		1	1 unit	101	0.150
		0.37	0.9 ... 1.25	4	▶	3RU11 16-0KB0		1	1 unit	101	0.150
		0.55	1.1 ... 1.6	6	▶	3RU11 16-1AB0		1	1 unit	101	0.150
		0.75	1.4 ... 2	6	▶	3RU11 16-1BB0		1	1 unit	101	0.150
		0.75	1.8 ... 2.5	10	▶	3RU11 16-1CB0		1	1 unit	101	0.150
		1.1	2.2 ... 3.2	10	▶	3RU11 16-1DB0		1	1 unit	101	0.150
		1.5	2.8 ... 4	16	▶	3RU11 16-1EB0		1	1 unit	101	0.150
		1.5	3.5 ... 5	20	▶	3RU11 16-1FB0		1	1 unit	101	0.150
2.2	4.5 ... 6.3	20	▶	3RU11 16-1GB0		1	1 unit	101	0.150		
3	5.5 ... 8	25	▶	3RU11 16-1HB0		1	1 unit	101	0.150		
4	7 ... 10	35	▶	3RU11 16-1JB0		1	1 unit	101	0.150		
5.5	9 ... 12	35	▶	3RU11 16-1KB0		1	1 unit	101	0.150		
Size S0											
	S0	0.75	1.8 ... 2.5	10	▶	3RU11 26-1CB0		1	1 unit	101	0.190
		1.1	2.2 ... 3.2	10	▶	3RU11 26-1DB0		1	1 unit	101	0.190
		1.5	2.8 ... 4	16	▶	3RU11 26-1EB0		1	1 unit	101	0.190
		1.5	3.5 ... 5	20	▶	3RU11 26-1FB0		1	1 unit	101	0.190
		2.2	4.5 ... 6.3	20	▶	3RU11 26-1GB0		1	1 unit	101	0.190
		3	5.5 ... 8	25	▶	3RU11 26-1HB0		1	1 unit	101	0.190
		4	7 ... 10	35	▶	3RU11 26-1JB0		1	1 unit	101	0.190
		5.5	9 ... 12.5	35	▶	3RU11 26-1KB0		1	1 unit	101	0.190
		7.5	11 ... 16	40	▶	3RU11 26-4AB0		1	1 unit	101	0.190
		7.5	14 ... 20	50	▶	3RU11 26-4BB0		1	1 unit	101	0.190
		11	17 ... 22	63	▶	3RU11 26-4CB0		1	1 unit	101	0.190
11	20 ... 25	63	▶	3RU11 26-4DB0		1	1 unit	101	0.190		
Size S2											
	S2	3	5.5 ... 8	25	A	3RU11 36-1HB0		1	1 unit	101	0.320
		4	7 ... 10	35	A	3RU11 36-1JB0		1	1 unit	101	0.320
		5.5	9 ... 12.5	35	A	3RU11 36-1KB0		1	1 unit	101	0.320
		7.5	11 ... 16	40	▶	3RU11 36-4AB0		1	1 unit	101	0.320
		7.5	14 ... 20	50	▶	3RU11 36-4BB0		1	1 unit	101	0.320
		11	18 ... 25	63	▶	3RU11 36-4DB0		1	1 unit	101	0.320
		15	22 ... 32	80	▶	3RU11 36-4EB0		1	1 unit	101	0.320
		18.5	28 ... 40	80	▶	3RU11 36-4FB0		1	1 unit	101	0.320
		22	36 ... 45	100	▶	3RU11 36-4GB0		1	1 unit	101	0.320
		22	40 ... 50	100	▶	3RU11 36-4HB0		1	1 unit	101	0.320
Size S3											
	S3	11	18 ... 25	63	A	3RU11 46-4DB0		1	1 unit	101	0.550
		15	22 ... 32	80	A	3RU11 46-4EB0		1	1 unit	101	0.550
		18.5	28 ... 40	80	▶	3RU11 46-4FB0		1	1 unit	101	0.550
		22	36 ... 50	125	▶	3RU11 46-4HB0		1	1 unit	101	0.550
		30	45 ... 63	125	▶	3RU11 46-4JB0		1	1 unit	101	0.550
		37	57 ... 75	160	▶	3RU11 46-4KB0		1	1 unit	101	0.550
		45	70 ... 90	160	▶	3RU11 46-4LB0		1	1 unit	101	0.550
		45	80 ... 100 ⁵⁾	200	▶	3RU11 46-4MB0		1	1 unit	101	0.550

1) With the suitable terminal brackets (see Accessories) the 3RU11 overload relays for direct mounting can also be installed as stand-alone units.

2) Observe maximum rated operational current of the devices.

3) Standard value for 4-pole standard motors at 50 Hz 400 V AC. The actual starting and rated data of the motor to be protected must be considered when selecting the units.

4) Maximum fuse for overload relay, type of coordination 2. For fuse values in conjunction with contactors, see Technical Specifications, Short-Circuit Protection with Fuses/Motor Starter Protectors for Motor Feeders.

5) For overload relays > 100 A, see 3RB2.

Overload Relays

3RU1 Thermal Overload Relays

3RU11 for standard applications

3RU11 thermal overload relays with screw connection on the auxiliary current side for stand alone installation¹⁾, CLASS 10

Features and technical specifications:

- Overload and phase failure protection
- Auxiliary contacts 1 NO + 1 NC
- Manual and automatic RESET
- Switch position indicator
- TEST function
- STOP button
- Integrated, sealable cover

Size Con-tactor ²⁾	Rating for induction motor, Rated value ³⁾	Set current value of the inverse-time delayed overload trip	Short-circuit protection with fuse, type of coordination 2, gL/gG operational class ⁴⁾	DT	Order No.	Price per PU	PU (UNIT, SET, M)	PS*	PG	Weight per PU approx.
	kW	A	A							kg
Size S00										
S00	0.04	0.11 ... 0.16	0.5	B	3RU11 16-0AB1		1	1 unit	101	0.180
	0.06	0.14 ... 0.2	1	B	3RU11 16-0BB1		1	1 unit	101	0.180
	0.06	0.18 ... 0.25	1	B	3RU11 16-0CB1		1	1 unit	101	0.180
	0.09	0.22 ... 0.32	1.6	B	3RU11 16-0DB1		1	1 unit	101	0.180
	0.09	0.28 ... 0.4	2	A	3RU11 16-0EB1		1	1 unit	101	0.180
	0.12	0.35 ... 0.5	2	A	3RU11 16-0FB1		1	1 unit	101	0.180
	0.18	0.45 ... 0.63	2	A	3RU11 16-0GB1		1	1 unit	101	0.180
	0.18	0.55 ... 0.8	4	A	3RU11 16-0HB1		1	1 unit	101	0.180
	0.25	0.7 ... 1	4	▶	3RU11 16-0JB1		1	1 unit	101	0.180
	0.37	0.9 ... 1.25	4	▶	3RU11 16-0KB1		1	1 unit	101	0.180
	0.55	1.1 ... 1.6	6	▶	3RU11 16-1AB1		1	1 unit	101	0.180
	0.75	1.4 ... 2	6	▶	3RU11 16-1BB1		1	1 unit	101	0.180
	0.75	1.8 ... 2.5	10	▶	3RU11 16-1CB1		1	1 unit	101	0.180
	1.1	2.2 ... 3.2	10	▶	3RU11 16-1DB1		1	1 unit	101	0.180
	1.5	2.8 ... 4	16	▶	3RU11 16-1EB1		1	1 unit	101	0.180
	1.5	3.5 ... 5	20	▶	3RU11 16-1FB1		1	1 unit	101	0.180
	2.2	4.5 ... 6.3	20	▶	3RU11 16-1GB1		1	1 unit	101	0.180
	3	5.5 ... 8	25	▶	3RU11 16-1HB1		1	1 unit	101	0.180
	4	7 ... 10	35	▶	3RU11 16-1JB1		1	1 unit	101	0.180
	5.5	9 ... 12	35	A	3RU11 16-1KB1		1	1 unit	101	0.180
Size S0										
S0	7.5	11 ... 16	40	▶	3RU11 26-4AB1		1	1 unit	101	0.240
	7.5	14 ... 20	50	▶	3RU11 26-4BB1		1	1 unit	101	0.240
	11	17 ... 22	63	A	3RU11 26-4CB1		1	1 unit	101	0.240
	11	20 ... 25	63	▶	3RU11 26-4DB1		1	1 unit	101	0.240
Size S2										
S2	15	22 ... 32	80	▶	3RU11 36-4EB1		1	1 unit	101	0.480
	18.5	28 ... 40	80	▶	3RU11 36-4FB1		1	1 unit	101	0.480
	22	36 ... 45	100	A	3RU11 36-4GB1		1	1 unit	101	0.480
	22	40 ... 50	100	A	3RU11 36-4HB1		1	1 unit	101	0.480
Size S3										
S3	30	45 ... 63	125	▶	3RU11 46-4JB1		1	1 unit	101	0.810
	37	57 ... 75	160	A	3RU11 46-4KB1		1	1 unit	101	0.810
	45	70 ... 90	160	A	3RU11 46-4LB1		1	1 unit	101	0.810
	45	80 ... 100 ⁵⁾	200	A	3RU11 46-4MB1		1	1 unit	101	0.810

- 1) Size S00 to S3 for screw and snap-on mounting onto TH 35 standard mounting rails, size S3 also for TH 75 standard mounting rails.
- 2) Observe maximum rated operational current of the devices.
- 3) Standard value for 4-pole standard motors at 50 Hz 400 V AC. The actual starting and rated data of the motor to be protected must be considered when selecting the units.
- 4) Maximum fuse for overload relay, type of coordination 2. For fuse values in conjunction with contactors, see Technical Specifications, Short-Circuit Protection with Fuses/Motor Starter Protectors for Motor Feeders.
- 5) For overload relays > 100 A, see 3RB2.

* You can order this quantity or a multiple thereof.

Overload Relays

3RU1 Thermal Overload Relays

3RU11 for standard applications

3RU11 thermal overload relays with Cage Clamp connection for direct mounting¹⁾ and stand-alone installation²⁾, CLASS 10

Features and technical specifications:

- Overload and phase failure protection
- Auxiliary contacts 1 NO + 1 NC
- Manual and automatic RESET
- Switch position indicator
- TEST function
- STOP button
- Integrated, sealable cover

Size Con-tactor ³⁾	Rating for induction motor Rated value ⁴⁾	Set current value of the inverse-time delayed overload trip	Short-circuit protection with fuse, type of coordination 2, gL/gG operational class ⁵⁾	DT	Order No.	Price per PU	PU (UNIT, SET, M)	PS*	PG	Weight per PU approx.
	kW	A	A							kg

Size S00 for stand-alone installation⁶⁾

	S00	0.04	0.11 ... 0.16	0.5	B	3RU11 16-0AC1		1	1 unit	101	0.190
		0.06	0.14 ... 0.2	1	B	3RU11 16-0BC1		1	1 unit	101	0.190
		0.06	0.18 ... 0.25	1	B	3RU11 16-0CC1		1	1 unit	101	0.190
		0.09	0.22 ... 0.32	1.6	B	3RU11 16-0DC1		1	1 unit	101	0.190
		0.09	0.28 ... 0.4	2	B	3RU11 16-0EC1		1	1 unit	101	0.190
		0.12	0.35 ... 0.5	2	B	3RU11 16-0FC1		1	1 unit	101	0.190
		0.18	0.45 ... 0.63	2	A	3RU11 16-0GC1		1	1 unit	101	0.190
		0.18	0.55 ... 0.8	4	A	3RU11 16-0HC1		1	1 unit	101	0.190
		0.25	0.7 ... 1	4	A	3RU11 16-0JC1		1	1 unit	101	0.190
		0.37	0.9 ... 1.25	4	A	3RU11 16-0KC1		1	1 unit	101	0.190
		0.55	1.1 ... 1.6	6	A	3RU11 16-1AC1		1	1 unit	101	0.190
		0.75	1.4 ... 2	6	A	3RU11 16-1BC1		1	1 unit	101	0.190
		0.75	1.8 ... 2.5	10	A	3RU11 16-1CC1		1	1 unit	101	0.190
		1.1	2.2 ... 3.2	10	A	3RU11 16-1DC1		1	1 unit	101	0.190
		1.5	2.8 ... 4	16	A	3RU11 16-1EC1		1	1 unit	101	0.190
		1.5	3.5 ... 5	20	A	3RU11 16-1FC1		1	1 unit	101	0.190
		2.2	4.5 ... 6.3	20	A	3RU11 16-1GC1		1	1 unit	101	0.190
3	5.5 ... 8	25	A	3RU11 16-1HC1		1	1 unit	101	0.190		
4	7 ... 10	35	A	3RU11 16-1JC1		1	1 unit	101	0.190		
5.5	9 ... 12	35	A	3RU11 16-1KC1		1	1 unit	101	0.190		

Size S0 for direct mounting¹⁾⁷⁾

	S0	0.75	1.8 ... 2.5	10	B	3RU11 26-1CD0		1	1 unit	101	0.190
		1.1	2.2 ... 3.2	10	B	3RU11 26-1DD0		1	1 unit	101	0.190
		1.5	2.8 ... 4	16	B	3RU11 26-1ED0		1	1 unit	101	0.190
		1.5	3.5 ... 5	20	B	3RU11 26-1FD0		1	1 unit	101	0.190
		2.2	4.5 ... 6.3	20	B	3RU11 26-1GD0		1	1 unit	101	0.190
		3	5.5 ... 8	25	B	3RU11 26-1HD0		1	1 unit	101	0.190
		4	7 ... 10	35	B	3RU11 26-1JD0		1	1 unit	101	0.190
		5.5	9 ... 12.5	35	B	3RU11 26-1KD0		1	1 unit	101	0.190
		7.5	11 ... 16	40	A	3RU11 26-4AD0		1	1 unit	101	0.190
		7.5	14 ... 20	50	A	3RU11 26-4BD0		1	1 unit	101	0.190
		11	17 ... 22	63	A	3RU11 26-4CD0		1	1 unit	101	0.190
11	20 ... 25	63	A	3RU11 26-4DD0		1	1 unit	101	0.190		

Size S2 for direct mounting¹⁾⁷⁾

	S2	3	5.5 ... 8	25	B	3RU11 36-1HD0		1	1 unit	101	0.320
		4	7 ... 10	35	B	3RU11 36-1JD0		1	1 unit	101	0.320
		5.5	9 ... 12.5	35	B	3RU11 36-1KD0		1	1 unit	101	0.320
		7.5	11 ... 16	40	B	3RU11 36-4AD0		1	1 unit	101	0.320
		7.5	14 ... 20	50	B	3RU11 36-4BD0		1	1 unit	101	0.320
		11	18 ... 25	63	B	3RU11 36-4DD0		1	1 unit	101	0.320
		15	22 ... 32	80	A	3RU11 36-4ED0		1	1 unit	101	0.320
		18.5	28 ... 40	80	A	3RU11 36-4FD0		1	1 unit	101	0.320
		22	36 ... 45	100	A	3RU11 36-4GD0		1	1 unit	101	0.320
		22	40 ... 50	100	A	3RU11 36-4HD0		1	1 unit	101	0.320

Size S3 for direct mounting¹⁾⁷⁾

	S3	11	18 ... 25	63	B	3RU11 46-4DD0		1	1 unit	101	0.550
		15	22 ... 32	80	B	3RU11 46-4ED0		1	1 unit	101	0.550
		18.5	28 ... 40	80	B	3RU11 46-4FD0		1	1 unit	101	0.550
		22	36 ... 50	125	B	3RU11 46-4HD0		1	1 unit	101	0.550
		30	45 ... 63	125	A	3RU11 46-4JD0		1	1 unit	101	0.550
		37	57 ... 75	160	A	3RU11 46-4KD0		1	1 unit	101	0.550
		45	70 ... 90	160	A	3RU11 46-4LD0		1	1 unit	101	0.550
		45	80 ... 100	200	A	3RU11 46-4MD0		1	1 unit	101	0.550

1) With the suitable terminal brackets (see Accessories) the 3RU11 overload relays for direct mounting can also be installed as stand-alone units.

2) Size S00 for screw and snap-on mounting onto TR35 standard mounting rail.

3) Observe maximum rated operational current of the devices.

4) Standard value for 4-pole standard motors at 50 Hz 400 V AC. The actual starting and rated data of the motor to be protected must be considered when selecting the units.

5) Maximum fuse for overload relay, type of coordination 2. For fuse values in conjunction with contactors, see Technical Specifications, Short-Circuit Protection with Fuses/Motor Starter Protectors for Motor Feeders.

6) Auxiliary and main conductor terminals with Cage Clamp connection.

7) Auxiliary conductor terminals with Cage Clamp connection and main conductor terminals with screw connection.

Overload Relays

3RU1 Thermal Overload Relays





Accessories

Overview

The following accessories are available for the 3RU11 thermal overload relays:

- For the four overload relay sizes S00 to S3 one terminal bracket each for stand-alone installation
- One electrical remote RESET module in three voltage variants for all sizes
- One mechanical RESET module for all sizes
- One cable release for resetting devices which are difficult to access (for all sizes)
- Terminal covers

Selection and ordering data



Version	Size	DT	Order No.	Price per PU	PU (UNIT, SET, M)	PS*	PG	Weight per PU approx. kg	
Terminal brackets for stand-alone installation									
 <p>3RU19 0.6-3AA01</p>	For separate mounting of overload relays; screw and snap-on mounting onto TH35 standard mounting rail; size S3 also for TH75 standard mounting rail	S00	▶ 3RU19 16-3AA01		1	1 unit	101	0.060	
		S0	▶ 3RU19 26-3AA01		1	1 unit	101	0.080	
		S2	▶ 3RU19 36-3AA01		1	1 unit	101	0.180	
		S3	▶ 3RU19 46-3AA01		1	1 unit	101	0.280	
Mechanical RESET¹⁾									
 <p>3RU19 00-1A with pushbutton and extension plunger</p>	Resetting plungers, holders and formers	S00 ...S3	▶ 3RU19 00-1A		1	1 set	101	0.038	
	Pushbuttons with extended stroke (12 mm), IP65, Ø 22 mm		B	▶ 3SB30 00-0EA11		1	1 unit	102	0.021
	Extension plungers For compensation of the distance between a pushbutton and the unlatching button of the relay		A	▶ 3SX1 335		1	1 unit	102	0.004
Cable releases with holder for RESET¹⁾									
 <p>3RU19 00-1.</p>	For 6.5 mm Ø hole in the mounting plate; max. 8 mm control panel thickness	S00 ...S3							
	<ul style="list-style-type: none"> • Length 400 mm • Length 600 mm 		▶ 3RU19 00-1B		1	1 unit	101	0.063	
			▶ 3RU19 00-1C		1	1 unit	101	0.073	
Modules for remote RESET, electrical									
 <p>3RU19 00-2A.71</p>	Operating range	24 ... 30 V AC/DC	S00 ...S3	▶ 3RU19 00-2AB71		1	1 unit	101	0.066
	0.85 ... 1.1 x U _N , power consumption	110 ... 127 V AC/DC		▶ 3RU19 00-2AF71		1	1 unit	101	0.067
	80 VA AC, 70 W DC, ON period 0.2 ... 4 s, operating frequency 60/h	220 ... 250 V AC/DC		▶ 3RU19 00-2AM71		1	1 unit	101	0.066
Terminal covers¹⁾									
	Covers for cable lug and rail connections								
	• Length 55 mm	S3	▶ 3RT19 46-4EA1		1	1 unit	101	0.037	
	Covers for box terminals								
	• Length 20.6 mm	S2	▶ 3RT19 36-4EA2		1	1 unit	101	0.016	
	• Length 20.8 mm	S3	▶ 3RT19 46-4EA2		1	1 unit	101	0.023	

¹⁾ The accessories are identical to those of the 3RB2 solid-state overload relays.

Overload Relays

3RU1 Thermal Overload Relays

Accessories

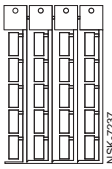
Version	Size/Color	Use	DT	Order No.	Price per PU	PU (UNIT, SET, M)	PS*	PG	Weight per PU approx. kg	
Tools for opening Cage Clamp terminals										
	3.5 x 0.5 mm, suitable for a max. conductor cross-section of 2.5 mm ²	Length approx. 175 mm; green; partially insulated	SIRIUS units with spring-loaded/Cage Clamp connections	A	8WA2 880		1	1 unit	041	0.012
8WA2 880										
		Length approx. 175 mm; green		A	8WA2 803		1	1 unit	041	0.024
8WA2 803										
	2.5 x 0.4 mm, suitable for a max. conductor cross-section of 1.5 mm ²	Length approx. 160 mm; green		A	8WA2 807		1	1 unit	041	0.023
8WA2 807										
Blank labeling plates										
	Device labeling plates	10 mm x 7 mm	3RU11, pastel turquoise	D	3RT19 00-1SB10		100	816 units	101	0.240
	For SIRIUS devices	20 mm x 7 mm	3RB2, pastel turquoise	C	3RT19 00-1SB20		100	340 units	101	0.220
	Labeling plates for sticking (labels)	19 mm x 6 mm	3RU11, pastel turquoise	D	3RT19 00-1SB60		100	3060 units	101	0.155
	For SIRIUS devices	19 mm x 6 mm	3RB2, zinc yellow	C	3RT19 00-1SD60		100	3060 units	101	0.120

PC labeling system

For individual inscription of device labeling plates

Obtainable from:

murrplastik Systemtechnik GmbH

(<http://www.murrplastik.com>)

X-ON Electronics

Authorized Distributor

Click to view similar products for [Siemens manufacturer](#).

Other Similar products are found below :

[018475A](#) [1000UH130MA](#) [14CP12BA81](#) [14CP32AF91](#) [14DP32AC81](#) [25876818007](#)

[3LD20030TK51](#) [3LD20030TK53](#) [3LD20031TL53](#) [3LD20130TK53](#) [3LD21030TK53](#)

[3LD22030TK53](#) [3LD22640TB53](#) [3LD22640TB530US2](#) [3LD25040TK51](#)

[3LD25040TK53](#) [3LD27040TK53](#) [3LD92005B](#) [3NA3105](#) [3NA3803](#) [3NA3810](#) [3NA3832](#)

[3NC1091](#) [3NE3225](#) [3NE3227](#)