

4N25(Short), 4N25A(Short), 4N26(Short), 4N27(Short), 4N28(Short)

- AC LINE /DIGITAL LOGIC ISOLATOR.
- DIGITAL LOGIC /DIGITAL LOGIC ISOLATOR.
- TELEPHONE LINE RECEIVER.
- TWISTED PAIR LINE RECEIVER.
- HIGH FREQUENCY POWER SUPPLY FEEDBACK CONTROL.
- RELAY CONTACT MONITOR.

The TOSHIBA 4N25 (Short) through 4N28 (Short) consists of a gallium arsenide infrared emitting diode coupled with a silicon phototransistor in a dual in-line package.

- Switching Speeds : $3\mu s$ (Typ.)
- DC Current Transfer Ratio : 100% (Typ.)
- Isolation Resistance : $10^{11}\Omega$ (Min.)
- Isolation Voltage : 2500Vrms (Min.)
- UL Recognized : UL1577, File No. E67349

Unit in mm

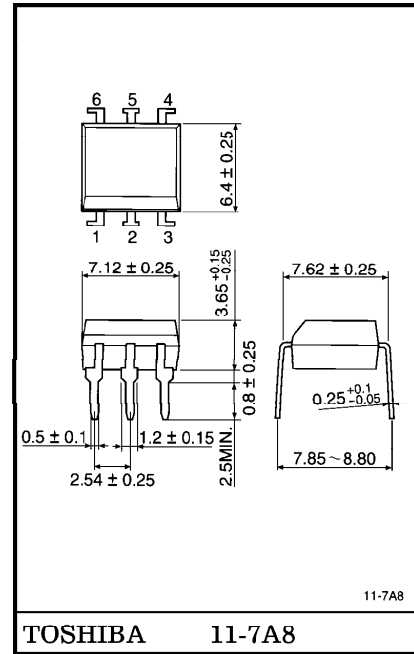

Weight : 0.4g

PIN CONFIGURATIONS (Top view)

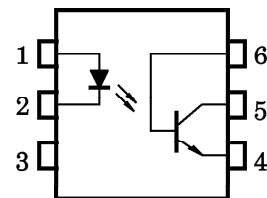

- 1 : ANODE
- 2 : CATHODE
- 3 : N.C.
- 4 : EMITTER
- 5 : COLLECTOR
- 6 : BASE

961001EBC2

● TOSHIBA is continually working to improve the quality and the reliability of its products. Nevertheless, semiconductor devices in general can malfunction or fail due to their inherent electrical sensitivity and vulnerability to physical stress. It is the responsibility of the buyer, when utilizing TOSHIBA products, to observe standards of safety, and to avoid situations in which a malfunction or failure of a TOSHIBA product could cause loss of human life, bodily injury or damage to property. In developing your designs, please ensure that TOSHIBA products are used within specified operating ranges as set forth in the most recent products specifications. Also, please keep in mind the precautions and conditions set forth in the TOSHIBA Semiconductor Reliability Handbook.

● Gallium arsenide (GaAs) is a substance used in the products described in this document. GaAs dust and fumes are toxic. Do not break, cut or pulverize the product, or use chemicals to dissolve them. When disposing of the products, follow the appropriate regulations. Do not dispose of the products with other industrial waste or with domestic garbage.

● The products described in this document are subject to foreign exchange and foreign trade control laws.

● The information contained herein is presented only as a guide for the applications of our products. No responsibility is assumed by TOSHIBA CORPORATION for any infringements of intellectual property or other rights of the third parties which may result from its use. No license is granted by implication or otherwise under any intellectual property or other rights of TOSHIBA CORPORATION or others.

● The information contained herein is subject to change without notice.

MAXIMUM RATINGS (Ta = 25°C)

CHARACTERISTIC		SYMBOL	RATING	UNIT
LED	Forward Current (Continuous)	I_F	80	mA
	Forward Current Derating	$\Delta I_F / ^\circ C$	1.07 (*)	mA / °C
	Peak Forward Current (Note 1)	I_{PF}	3	A
	Power Dissipation	P_D	150	mW
	Power Dissipation Derating	$\Delta P_D / ^\circ C$	2.0 (*)	mW / °C
	Reverse Voltage	V_R	3	V
DETECTOR	Collector-Emitter Voltage	BV_{CEO}	30	V
	Collector-Base Voltage	BV_{CBO}	70	V
	Emitter-Collector Voltage	BV_{ECO}	7	V
	Collector Current (Continuous)	I_C	100	mA
	Power Dissipation	P_C	150	mW
	Power Dissipation Derating	$\Delta P_C / ^\circ C$	2.0 (*)	mW / °C
COUPLED	Storage Temperature Range	T_{stg}	-55~150	°C
	Operating Temperature Range	T_{opr}	-55~100	°C
	Lead Soldering Temperature (10s)	T_{sol}	260	°C
	Total Package Power Dissipation	P_T	250	mW
	Total Package Power Dissipation Derating	$\Delta P_T / ^\circ C$	3.3 (*)	mW / °C

(Note 1) Pulse width 300 μ s, 2% duty cycle.

(*) Above 25°C ambient.

ELECTRICAL CHARACTERISTICS (Ta = 25°C)

CHARACTERISTIC		SYMBOL	TEST CONDITION	MIN.	TYP.	MAX.	UNIT	
LED	Forward Voltage	V _F	I _F = 10mA	—	1.15	1.5	V	
	Reverse Current	I _R	V _R = 3V	—	—	100	μA	
	Capacitance	C _D	V = 0, f = 1MHz	—	30	—	pF	
DETECTOR	DC Forward Current Gain	h _{FE}	V _{CE} = 5V, I _C = 500μA	—	200	—	—	
	Collector-Emitter Breakdown Voltage	V _{(BR)CEO}	I _C = 1mA, I _F = 0	30	—	—	V	
	Collector-Base Breakdown Voltage	V _{(BR)CBO}	I _C = 100μA	70	—	—	V	
	Emitter-Collector Breakdown Voltage	V _{(BR)ECO}	I _E = 100μA	7	—	—	V	
	Collector Dark Current	I _{CEO}	V _{CE} = 10V	—	1	50	nA	
	Collector Dark Current	I _{CBO}	V _{CB} = 10V	—	0.1	20	nA	
	Collector-Emitter Capacitance	C _{CE}	V = 0, f = 1MHz	—	10	—	pF	
	COUPLED	Current Transfer Ratio	I _C / I _F	I _F = 10mA, V _{CE} = 10V	20	100	—	%
Collector-Emitter Saturation Voltage		V _{CE(sat)}	I _F = 50mA, I _C = 2mA	—	0.1	0.5	V	
Capacitance Input to Output		C _S	V _S = 0, f = 1MHz	—	0.8	—	pF	
Isolation Resistance		R _S	V _S = 500V, R. H. ≤ 60%	10 ¹¹	—	—	Ω	
Isolation Voltage			BV _S	AC, 1 minute	2500	—	—	Vrms
			BV _S (*)	AC, Peak	2500	—	—	Vpk
					1500	—	—	
					500	—	—	
			AC, 1 second	1775	—	—	Vrms	
Rise / Fall Time		t _r / t _f	V _{CE} = 10V, I _C = 2mA R _L = 100Ω	—	2	—	μs	
Rise / Fall Time	t _r / t _f	V _{CB} = 10V, I _{CB} = 50μA R _L = 100Ω	—	200	—	ns		

(*) JEDEC registered minimum BV_S, however, TOSHIBA specifies a minimum BV_S of 2500Vrms, 1 minute.

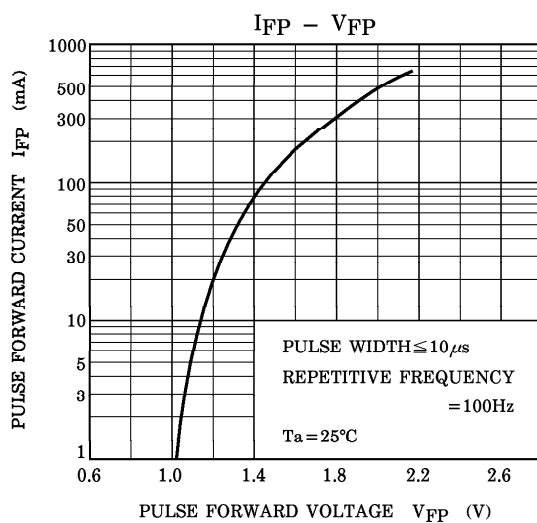
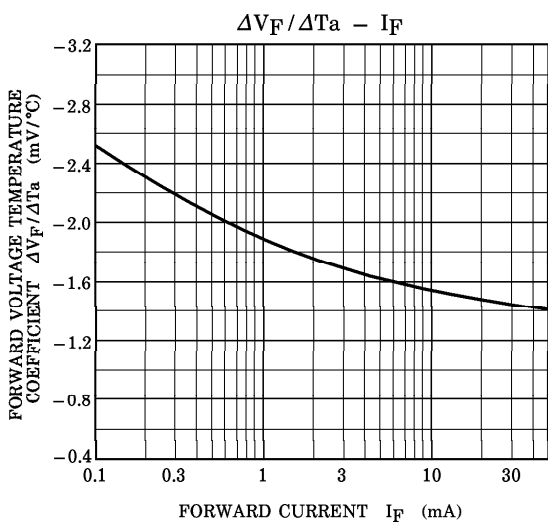
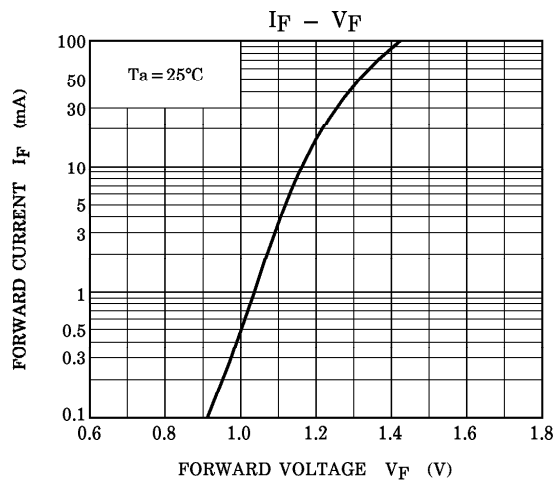
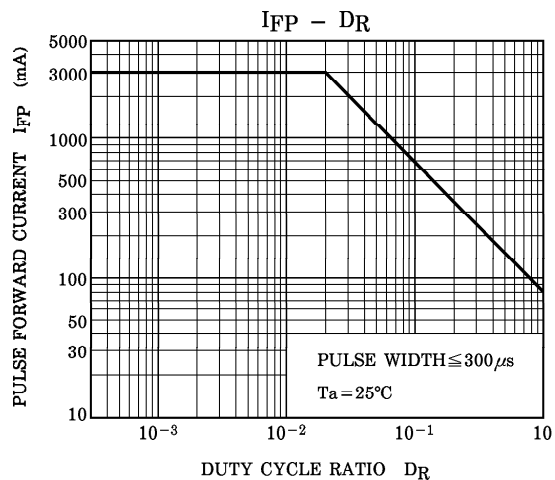
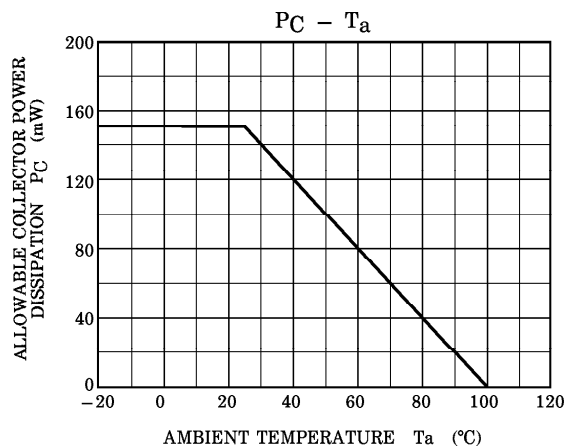
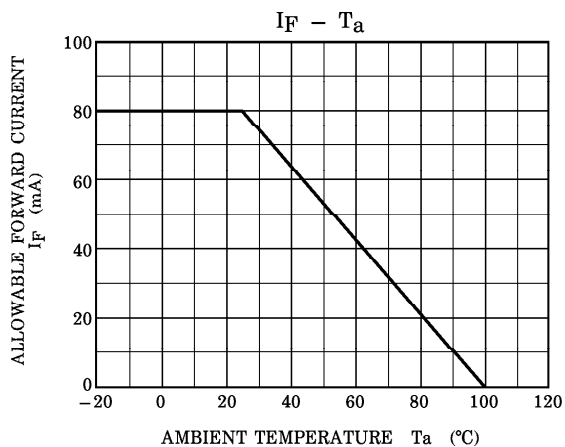

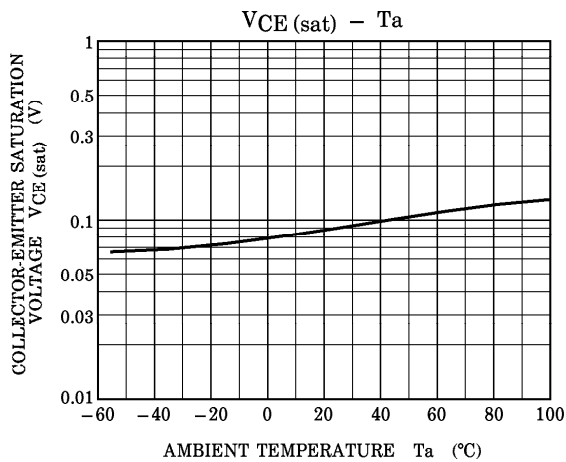
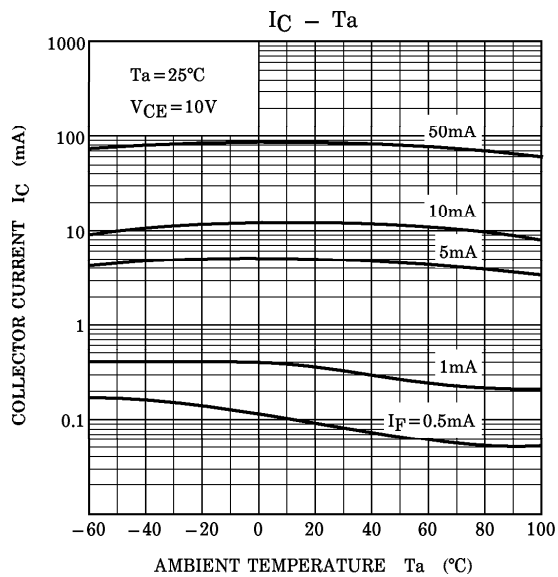
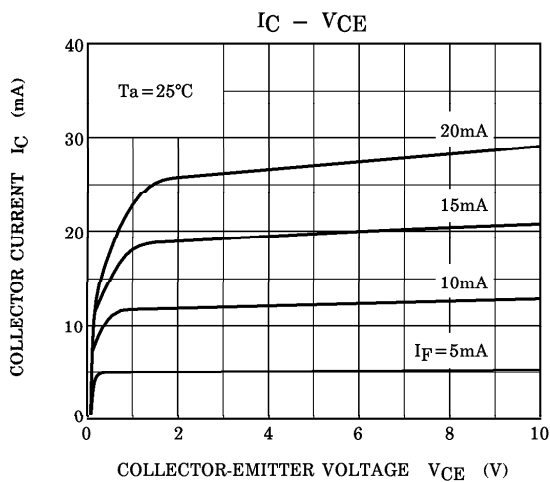
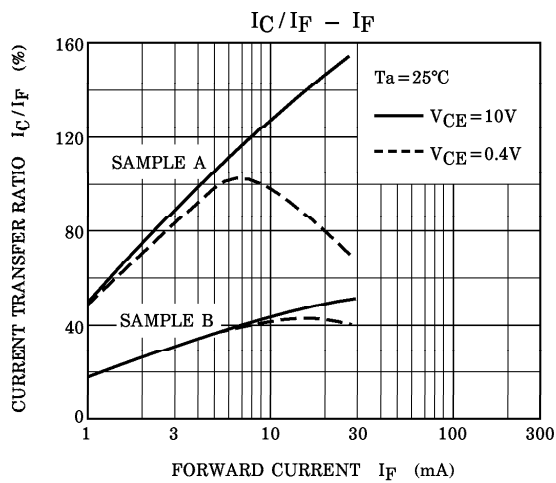
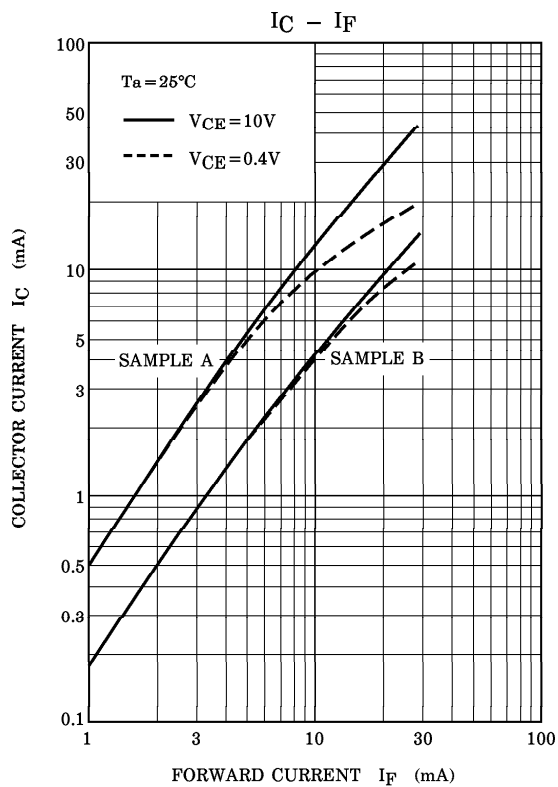

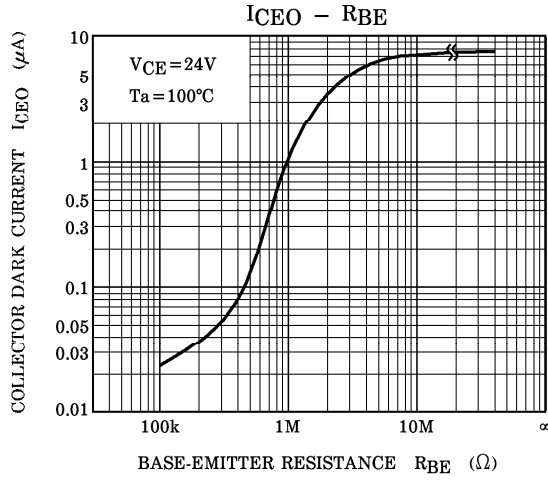
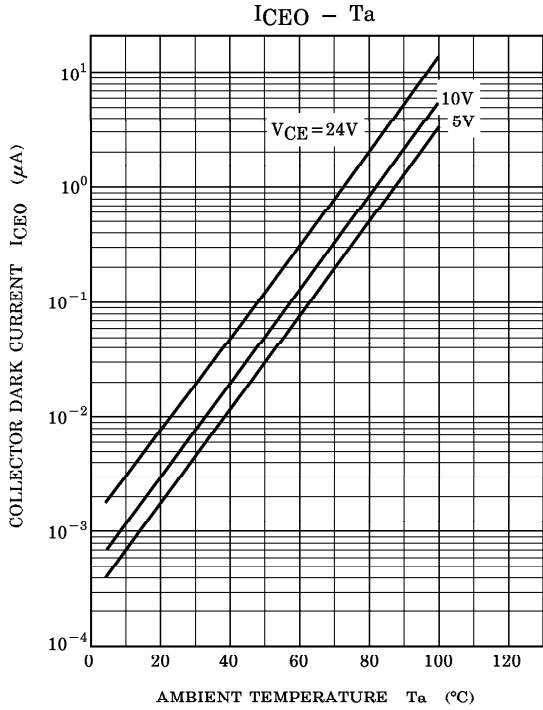

SWITCHING CHARACTERISTICS - R_{BE} (SATURATED OPERATION)

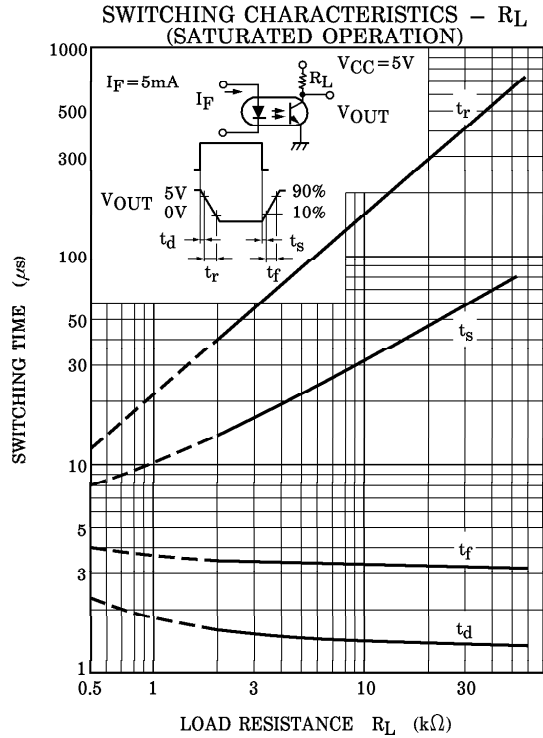
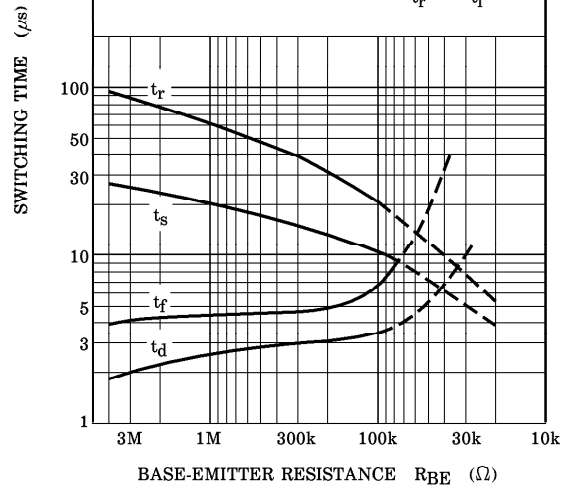
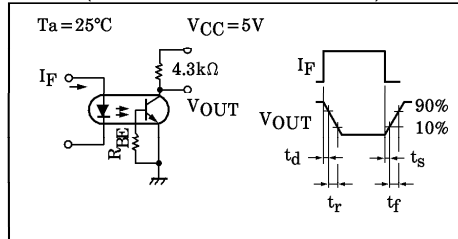

X-ON Electronics

Largest Supplier of Electrical and Electronic Components

Click to view similar products for [High Speed Optocouplers](#) category:

Click to view products by [Toshiba](#) manufacturer:

Other Similar products are found below :

[PS8502L2-AX](#) [ACNW261L-000E](#) [ACPL-344JT-000E](#) [ACPL-K49T-500E](#) [ACPL-K74T-000E](#) [ACPL-K75T-000E](#) [ACPL-W21L-560E](#) [ACPL-K44T-500E](#) [TLP187\(TPL,E\(T](#) [TLP2601\(TP1,F\)](#) [610737H](#) [6N137A-X001](#) [6N137A-X017T](#) [6N139-X007T](#) [HCPL2630M](#) [HCPL2731SM](#) [TLP555\(F\)](#) [HCPL2630SM](#) [PS2841-4A-F3-AX](#) [PS9817A-1-F3-AX](#) [PS9821-2-F3-AX](#) [ORPC-817D](#) [ORPC-817M/C](#) [ORPC-817M/B](#) [PT17-51C/L129\(BIN2\)](#) [TLP521-4GBSM](#) [UMW817C](#) [6N137S1\(TA\)](#) [TLP521GB](#) [TLP521GB-S](#) [PS2501](#) [PS2501-S](#) [TLP785GB](#) [TLP785GB-S](#) [LTV-214-G](#) [TLP2766A\(E](#) [TLP2766A\(LF4,E](#) [LCR-0202](#) [EL814S1\(TA\)-V](#) [PC817X4NSZ2B](#) [CYPC817](#) [OR-MOC3023](#) [TLP267J\(TPL,E\(T](#) [TLP109\(TPL,E\(O](#) [EL2514S1\(TU\)\(CLW\)-G](#) [EL816S2\(C\)\(TU\)-F](#) [TLP281-4](#) [MOC3023M](#) [ACPL-K49T-060E](#) [ACPL-K75T-500E](#)