

74AHC00; 74AHCT00

Quad 2-input NAND gate

Rev. 04 — 28 April 2008

Product data sheet

1. General description

The 74AHC00; 74AHCT00 is a high-speed Si-gate CMOS device and is pin compatible with Low-power Schottky TTL (LSTTL). It is specified in compliance with JEDEC standard No. JESD7-A.

The 74AHC00; 74AHCT00 provides the quad 2-input NAND function.

2. Features

- Balanced propagation delays
- All inputs have Schmitt-trigger actions
- Inputs accept voltages higher than V_{CC}
- Input levels:
 - ◆ For 74AHC00: CMOS level
 - ◆ For 74AHCT00: TTL level
- ESD protection:
 - ◆ HBM EIA/JESD22-A114E exceeds 2000 V
 - ◆ MM EIA/JESD22-A115-A exceeds 200 V
 - ◆ CDM EIA/JESD22-C101C exceeds 1000 V
- Multiple package options
- Specified from $-40\text{ }^{\circ}\text{C}$ to $+85\text{ }^{\circ}\text{C}$ and from $-40\text{ }^{\circ}\text{C}$ to $+125\text{ }^{\circ}\text{C}$

3. Ordering information

Table 1. Ordering information

Type number	Package			Version
	Temperature range	Name	Description	
74AHC00				
74AHC00D	$-40\text{ }^{\circ}\text{C}$ to $+125\text{ }^{\circ}\text{C}$	SO14	plastic small outline package; 14 leads; body width 3.9 mm	SOT108-1
74AHC00PW	$-40\text{ }^{\circ}\text{C}$ to $+125\text{ }^{\circ}\text{C}$	TSSOP14	plastic thin shrink small outline package; 14 leads; body width 4.4 mm	SOT402-1
74AHC00BQ	$-40\text{ }^{\circ}\text{C}$ to $+125\text{ }^{\circ}\text{C}$	DHVQFN14	plastic dual in-line compatible thermal enhanced very thin quad flat package; no leads; 14 terminals; body $2.5 \times 3 \times 0.85\text{ mm}$	SOT762-1

Table 1. Ordering information ...continued

Type number	Package			Version
	Temperature range	Name	Description	
74AHCT00				
74AHCT00D	-40 °C to +125 °C	SO14	plastic small outline package; 14 leads; body width 3.9 mm	SOT108-1
74AHCT00PW	-40 °C to +125 °C	TSSOP14	plastic thin shrink small outline package; 14 leads; body width 4.4 mm	SOT402-1
74AHCT00BQ	-40 °C to +125 °C	DHVQFN14	plastic dual in-line compatible thermal enhanced very thin quad flat package; no leads; 14 terminals; body 2.5 × 3 × 0.85 mm	SOT762-1

4. Functional diagram

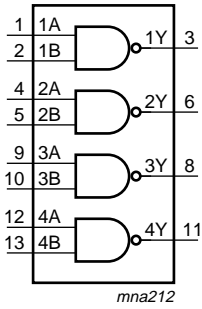

mna212

Fig 1. Logic symbol

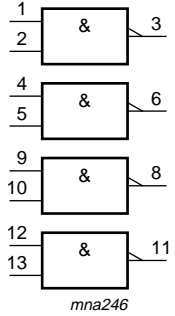

mna246

Fig 2. IEC logic symbol

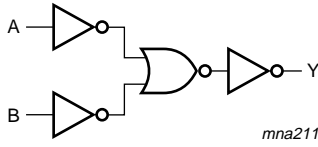

mna211

Fig 3. Logic diagram (one gate)

5. Pinning information

5.1 Pinning

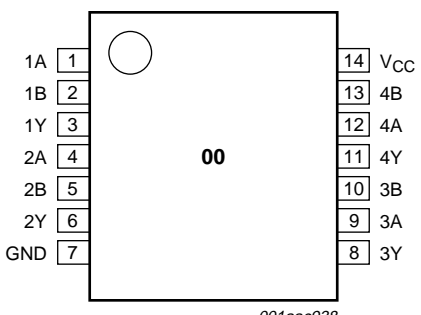

001aac938

Fig 4. Pin configuration SO14 and TSSOP14

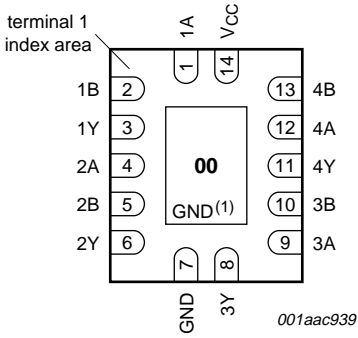

001aac939

Transparent top view

(1) The die substrate is attached to this pad using conductive die attach material. It can not be used as a supply pin or input.

Fig 5. Pin configuration DHVQFN14

5.2 Pin description

Table 2. Pin description

Symbol	Pin	Description
1A	1	data input
1B	2	data input
1Y	3	data output
2A	4	data input
2B	5	data input
2Y	6	data output
GND	7	ground (0 V)
3Y	8	data output
3A	9	data input
3B	10	data input
4Y	11	data output
4A	12	data input
4B	13	data input
V _{CC}	14	supply voltage

6. Functional description

Table 3. Function selection^[1]

Input		Output
nA	nB	nY
L	X	H
X	L	H
H	H	L

[1] H = HIGH voltage level; L = LOW voltage level; X = don't care.

7. Limiting values

Table 4. Limiting values

In accordance with the Absolute Maximum Rating System (IEC 60134). Voltages are referenced to GND (ground = 0 V).

Symbol	Parameter	Conditions	Min	Max	Unit
V_{CC}	supply voltage		-0.5	+7.0	V
V_I	input voltage		-0.5	+7.0	V
I_{IK}	input clamping current	$V_I < -0.5$ V	[1] -20	-	mA
I_{OK}	output clamping current	$V_O < -0.5$ V or $V_O > V_{CC} + 0.5$ V	[1] -20	+20	mA
I_O	output current	$V_O = -0.5$ V to $(V_{CC} + 0.5)$ V	-25	+25	mA
I_{CC}	supply current		-	+75	mA
I_{GND}	ground current		-75	-	mA
T_{stg}	storage temperature		-65	+150	°C
P_{tot}	total power dissipation	$T_{amb} = -40$ °C to $+125$ °C	[2] -	500	mW

[1] The input and output voltage ratings may be exceeded if the input and output current ratings are observed.

[2] For SO14 packages: above 70 °C the value of P_{tot} derates linearly at 8 mW/K.

For TSSOP14 packages: above 60 °C the value of P_{tot} derates linearly at 5.5 mW/K.

For DHVQFN14 packages: above 60 °C the value of P_{tot} derates linearly at 4.5 mW/K.

8. Recommended operating conditions

Table 5. Operating conditions

Symbol	Parameter	Conditions	Min	Typ	Max	Unit
74AHC00						
V_{CC}	supply voltage		2.0	5.0	5.5	V
V_I	input voltage		0	-	5.5	V
V_O	output voltage		0	-	V_{CC}	V
T_{amb}	ambient temperature		-40	+25	+125	°C
$\Delta t/\Delta V$	input transition rise and fall rate	$V_{CC} = 3.0$ V to 3.6 V	-	-	100	ns/V
		$V_{CC} = 4.5$ V to 5.5 V	-	-	20	ns/V
74AHCT00						
V_{CC}	supply voltage		4.5	5.0	5.5	V
V_I	input voltage		0	-	5.5	V
V_O	output voltage		0	-	V_{CC}	V
T_{amb}	ambient temperature		-40	+25	+125	°C
$\Delta t/\Delta V$	input transition rise and fall rate	$V_{CC} = 4.5$ V to 5.5 V	-	-	20	ns/V

9. Static characteristics

Table 6. Static characteristics

At recommended operating conditions; voltages are referenced to GND (ground = 0 V).

Symbol	Parameter	Conditions	25 °C			-40 °C to +85 °C		-40 °C to +125 °C		Unit
			Min	Typ	Max	Min	Max	Min	Max	
74AHC00										
V _{IH}	HIGH-level input voltage	V _{CC} = 2.0 V	1.5	-	-	1.5	-	1.5	-	V
		V _{CC} = 3.0 V	2.1	-	-	2.1	-	2.1	-	V
		V _{CC} = 5.5 V	3.85	-	-	3.85	-	3.85	-	V
V _{IL}	LOW-level input voltage	V _{CC} = 2.0 V	-	-	0.5	-	0.5	-	0.5	V
		V _{CC} = 3.0 V	-	-	0.9	-	0.9	-	0.9	V
		V _{CC} = 5.5 V	-	-	1.65	-	1.65	-	1.65	V
V _{OH}	HIGH-level output voltage	V _I = V _{IH} or V _{IL}								
		I _O = -50 µA; V _{CC} = 2.0 V	1.9	2.0	-	1.9	-	1.9	-	V
		I _O = -50 µA; V _{CC} = 3.0 V	2.9	3.0	-	2.9	-	2.9	-	V
		I _O = -50 µA; V _{CC} = 4.5 V	4.4	4.5	-	4.4	-	4.4	-	V
		I _O = -4.0 mA; V _{CC} = 3.0 V	2.58	-	-	2.48	-	2.40	-	V
		I _O = -8.0 mA; V _{CC} = 4.5 V	3.94	-	-	3.80	-	3.70	-	V
V _{OL}	LOW-level output voltage	V _I = V _{IH} or V _{IL}								
		I _O = 50 µA; V _{CC} = 2.0 V	-	0	0.1	-	0.1	-	0.1	V
		I _O = 50 µA; V _{CC} = 3.0 V	-	0	0.1	-	0.1	-	0.1	V
		I _O = 50 µA; V _{CC} = 4.5 V	-	0	0.1	-	0.1	-	0.1	V
		I _O = 4.0 mA; V _{CC} = 3.0 V	-	-	0.36	-	0.44	-	0.55	V
		I _O = 8.0 mA; V _{CC} = 4.5 V	-	-	0.36	-	0.44	-	0.55	V
I _I	input leakage current	V _I = 5.5 V or GND; V _{CC} = 0 V to 5.5 V	-	-	0.1	-	1.0	-	2.0	µA
I _{CC}	supply current	V _I = V _{CC} or GND; I _O = 0 A; V _{CC} = 5.5 V	-	-	2.0	-	20	-	40	µA
C _I	input capacitance	V _I = V _{CC} or GND	-	3.0	10	-	10	-	10	pF
74AHCT00										
V _{IH}	HIGH-level input voltage	V _{CC} = 4.5 V to 5.5 V	2.0	-	-	2.0	-	2.0	-	V
V _{IL}	LOW-level input voltage	V _{CC} = 4.5 V to 5.5 V	-	-	0.8	-	0.8	-	0.8	V
V _{OH}	HIGH-level output voltage	V _I = V _{IH} or V _{IL} ; V _{CC} = 4.5 V								
		I _O = -50 µA	4.4	4.5	-	4.4	-	4.4	-	V
		I _O = -8.0 mA	3.94	-	-	3.80	-	3.70	-	V
V _{OL}	LOW-level output voltage	V _I = V _{IH} or V _{IL} ; V _{CC} = 4.5 V								
		I _O = 50 µA	-	0	0.1	-	0.1	-	0.1	V
		I _O = 8.0 mA	-	-	0.36	-	0.44	-	0.55	V
I _I	input leakage current	V _I = 5.5 V or GND; V _{CC} = 0 V to 5.5 V	-	-	0.1	-	1.0	-	2.0	µA

Table 6. Static characteristics ...continued

At recommended operating conditions; voltages are referenced to GND (ground = 0 V).

Symbol	Parameter	Conditions	25 °C			-40 °C to +85 °C		-40 °C to +125 °C		Unit
			Min	Typ	Max	Min	Max	Min	Max	
I _{CC}	supply current	V _I = V _{CC} or GND; I _O = 0 A; V _{CC} = 5.5 V	-	-	2.0	-	20	-	40	μA
ΔI _{CC}	additional supply current	per input pin; V _I = V _{CC} - 2.1 V; other pins at V _{CC} or GND; I _O = 0 A; V _{CC} = 4.5 V to 5.5 V	-	-	1.35	-	1.5	-	1.5	mA
C _I	input capacitance	V _I = V _{CC} or GND	-	3.0	10	-	10	-	10	pF

10. Dynamic characteristics

Table 7. Dynamic characteristics

Voltages are referenced to GND (ground = 0 V); for test circuit see [Figure 7](#).

Symbol	Parameter	Conditions	25 °C			-40 °C to +85 °C		-40 °C to +125 °C		Unit
			Min	Typ ^[1]	Max	Min	Max	Min	Max	

74AHC00

t _{pd}	propagation delay	nA, nB to nY; see Figure 6 ^[2]								
		V _{CC} = 3.0 V to 3.6 V								
		C _L = 15 pF	-	4.5	7.9	1.0	9.5	1.0	10.0	ns
		C _L = 50 pF	-	6.0	11.4	1.0	13.0	1.0	14.5	ns
		V _{CC} = 4.5 V to 5.5 V								
		C _L = 15 pF	-	3.2	5.5	1.0	6.5	1.0	7.0	ns
C _{PD}	power dissipation capacitance	C _L = 50 pF; f _i = 1 MHz; ^[3]	-	7.0	-	-	-	-	-	pF
		V _I = GND to V _{CC}								

74AHCT00

t _{pd}	propagation delay	nA, nB to nY; see Figure 6 ^[2]								
		V _{CC} = 4.5 V to 5.5 V								
		C _L = 15 pF	-	3.3	6.9	1.0	8.0	1.0	9.0	ns
C _{PD}	power dissipation capacitance	C _L = 50 pF; f _i = 1 MHz; ^[3]	-	7.0	-	-	-	-	-	pF
		V _I = GND to V _{CC}								

[1] Typical values are measured at nominal supply voltage (V_{CC} = 3.3 V and V_{CC} = 5.0 V).

[2] t_{pd} is the same as t_{PLH} and t_{PHL}.

[3] C_{PD} is used to determine the dynamic power dissipation (P_D in μW).

$$P_D = C_{PD} \times V_{CC}^2 \times f_i \times N + \Sigma(C_L \times V_{CC}^2 \times f_o) \text{ where:}$$

f_i = input frequency in MHz;

f_o = output frequency in MHz;

C_L = output load capacitance in pF;

V_{CC} = supply voltage in V;

N = number of inputs switching;

Σ(C_L × V_{CC}² × f_o) = sum of the outputs.

11. Waveforms

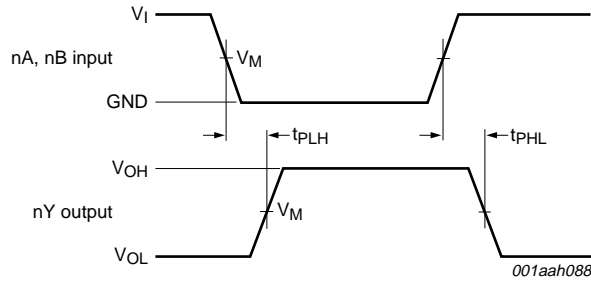

Measurement points are given in [Table 8](#).
 V_{OL} and V_{OH} are typical voltage output levels that occur with the output load.

Fig 6. Input to output propagation delays

Table 8. Measurement points

Type	Input	Output
	V_M	V_M
74AHC00	$0.5 \times V_{CC}$	$0.5 \times V_{CC}$
74AHCT00	1.5 V	$0.5 \times V_{CC}$

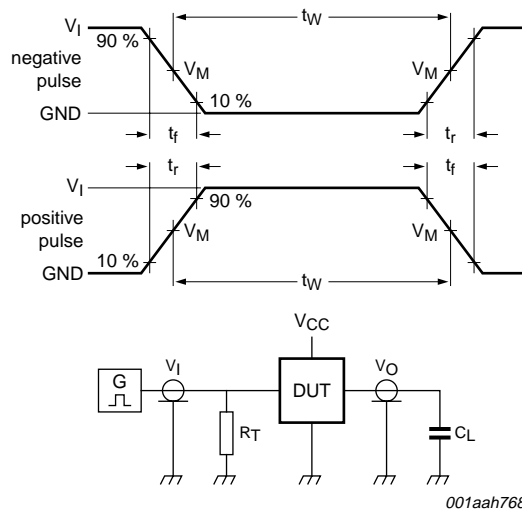

Test data is given in [Table 9](#).
 Definitions test circuit:
 R_T = termination resistance should be equal to output impedance Z_o of the pulse generator.
 C_L = load capacitance including jig and probe capacitance.

Fig 7. Load circuitry for measuring switching times

Table 9. Test data

Type	Input		Load	Test
	V _I	t _r , t _f	C _L	
74AHC00	V _{CC}	≤ 3.0 ns	15 pF, 50 pF	t _{PLH} , t _{PHL}
74AHCT00	3.0 V	≤ 3.0 ns	15 pF, 50 pF	t _{PLH} , t _{PHL}

12. Package outline

SO14: plastic small outline package; 14 leads; body width 3.9 mm

SOT108-1

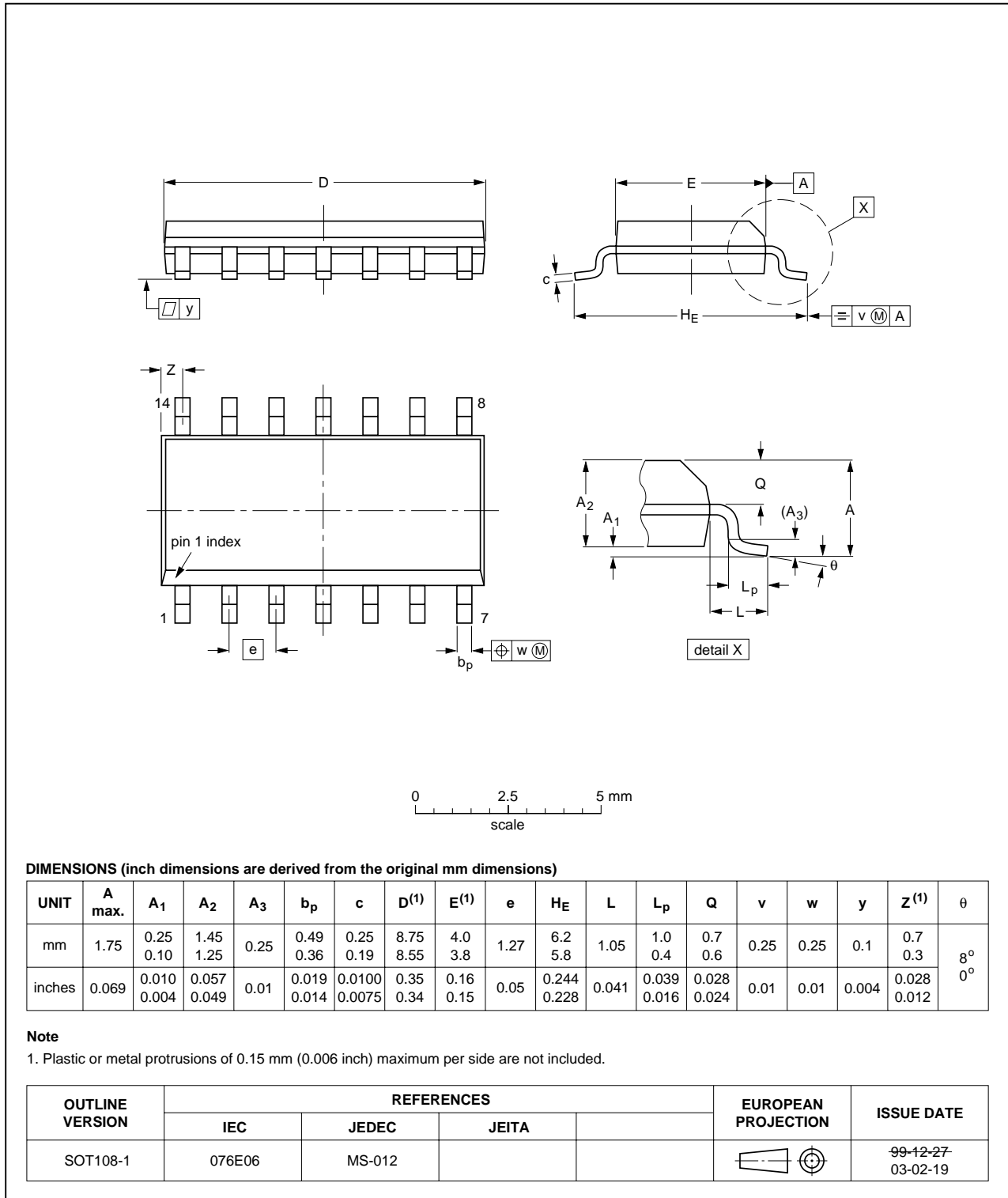

Fig 8. Package outline SOT108-1 (SO14)

TSSOP14: plastic thin shrink small outline package; 14 leads; body width 4.4 mm

SOT402-1

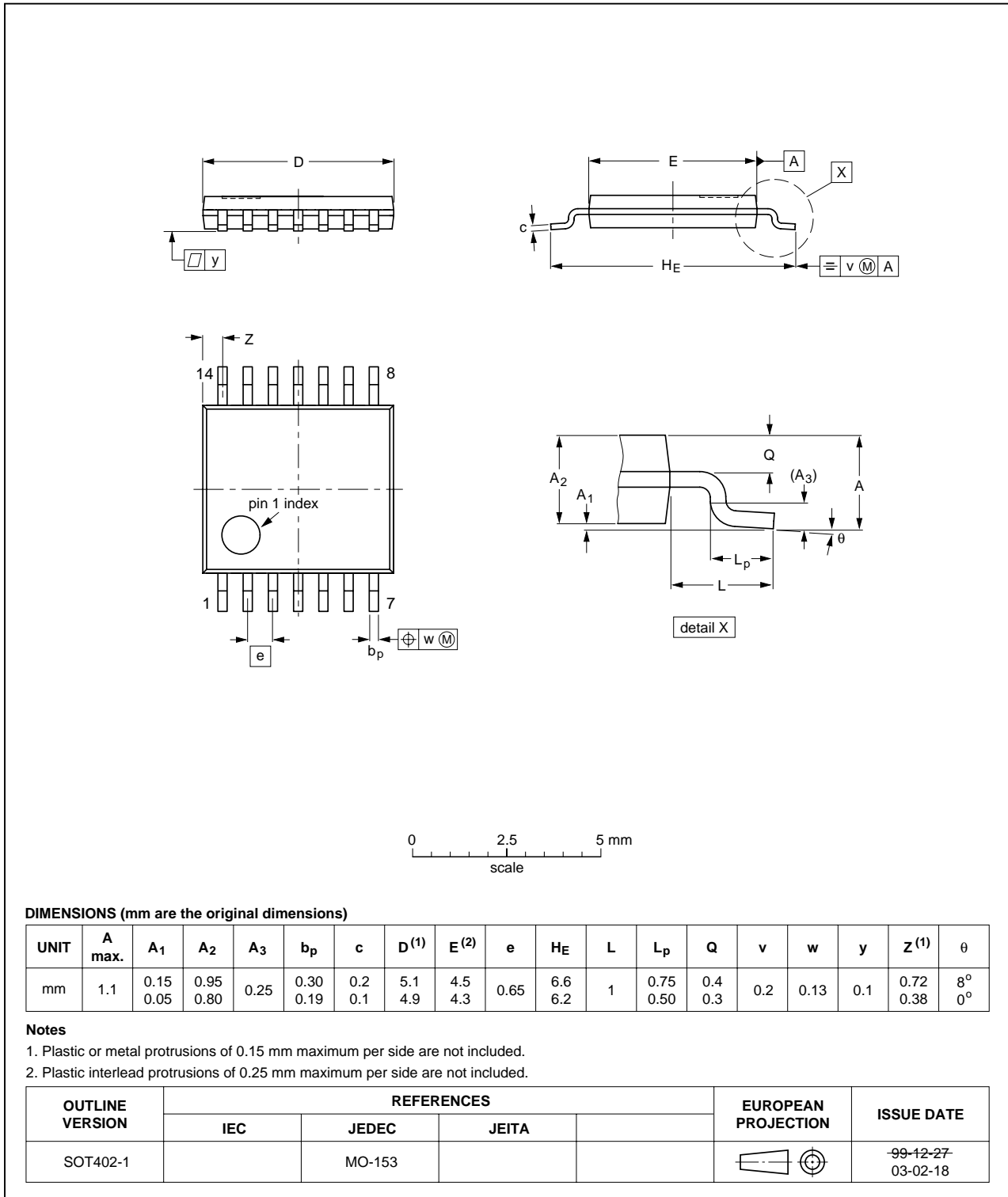

Fig 9. Package outline SOT402-1 (TSSOP14)

DHVQFN14: plastic dual in-line compatible thermal enhanced very thin quad flat package; no leads; 14 terminals; body 2.5 x 3 x 0.85 mm

SOT762-1

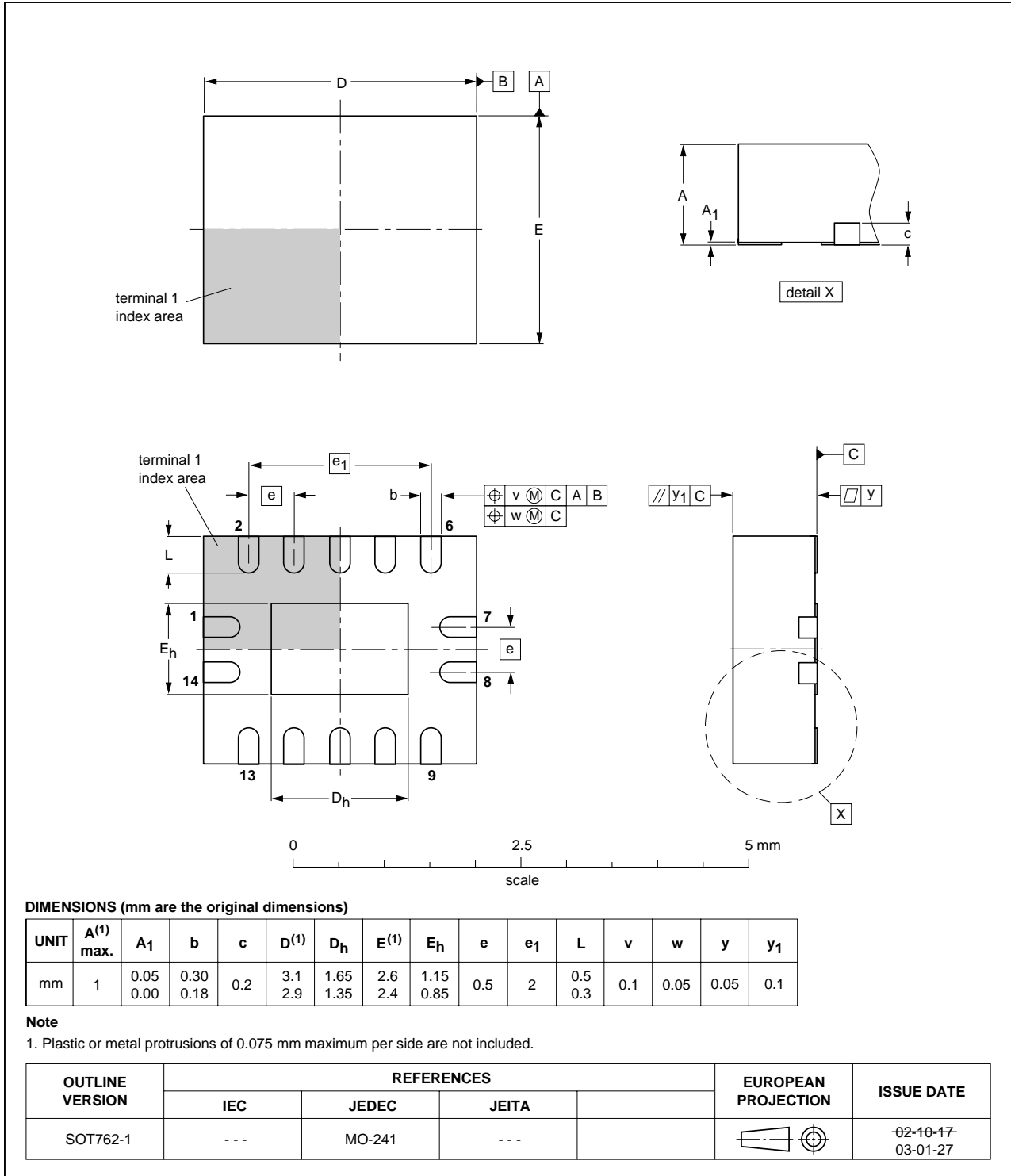

Fig 10. Package outline SOT762-1 (DHVQFN14)

13. Abbreviations

Table 10. Abbreviations

Acronym	Description
CDM	Charge Device Model
CMOS	Complementary Metal-Oxide Semiconductor
DUT	Device Under Test
ESD	ElectroStatic Discharge
HBM	Human Body Model
LSTTL	Low-power Schottky Transistor-Transistor Logic
MM	Machine Model
TTL	Transistor-Transistor Logic

14. Revision history

Table 11. Revision history

Document ID	Release date	Data sheet status	Change notice	Supersedes
74AHC_AHCT00_4	20080428	Product data sheet	-	74AHC_AHCT00_3
Modifications:	<ul style="list-style-type: none"> • Table 6: the conditions for input leakage current have been changed. 			
74AHC_AHCT00_3	20080108	Product data sheet	-	74AHC_AHCT00_2
74AHC_AHCT00_2	19990923	Product specification	-	74AHC_AHCT00_1
74AHC_AHCT00_1	19981209	Product specification	-	-

15. Legal information

15.1 Data sheet status

Document status ^{[1][2]}	Product status ^[3]	Definition
Objective [short] data sheet	Development	This document contains data from the objective specification for product development.
Preliminary [short] data sheet	Qualification	This document contains data from the preliminary specification.
Product [short] data sheet	Production	This document contains the product specification.

[1] Please consult the most recently issued document before initiating or completing a design.

[2] The term 'short data sheet' is explained in section "Definitions".

[3] The product status of device(s) described in this document may have changed since this document was published and may differ in case of multiple devices. The latest product status information is available on the Internet at URL <http://www.nxp.com>.

15.2 Definitions

Draft — The document is a draft version only. The content is still under internal review and subject to formal approval, which may result in modifications or additions. NXP Semiconductors does not give any representations or warranties as to the accuracy or completeness of information included herein and shall have no liability for the consequences of use of such information.

Short data sheet — A short data sheet is an extract from a full data sheet with the same product type number(s) and title. A short data sheet is intended for quick reference only and should not be relied upon to contain detailed and full information. For detailed and full information see the relevant full data sheet, which is available on request via the local NXP Semiconductors sales office. In case of any inconsistency or conflict with the short data sheet, the full data sheet shall prevail.

15.3 Disclaimers

General — Information in this document is believed to be accurate and reliable. However, NXP Semiconductors does not give any representations or warranties, expressed or implied, as to the accuracy or completeness of such information and shall have no liability for the consequences of use of such information.

Right to make changes — NXP Semiconductors reserves the right to make changes to information published in this document, including without limitation specifications and product descriptions, at any time and without notice. This document supersedes and replaces all information supplied prior to the publication hereof.

Suitability for use — NXP Semiconductors products are not designed, authorized or warranted to be suitable for use in medical, military, aircraft, space or life support equipment, nor in applications where failure or

malfunction of an NXP Semiconductors product can reasonably be expected to result in personal injury, death or severe property or environmental damage. NXP Semiconductors accepts no liability for inclusion and/or use of NXP Semiconductors products in such equipment or applications and therefore such inclusion and/or use is at the customer's own risk.

Applications — Applications that are described herein for any of these products are for illustrative purposes only. NXP Semiconductors makes no representation or warranty that such applications will be suitable for the specified use without further testing or modification.

Limiting values — Stress above one or more limiting values (as defined in the Absolute Maximum Ratings System of IEC 60134) may cause permanent damage to the device. Limiting values are stress ratings only and operation of the device at these or any other conditions above those given in the Characteristics sections of this document is not implied. Exposure to limiting values for extended periods may affect device reliability.

Terms and conditions of sale — NXP Semiconductors products are sold subject to the general terms and conditions of commercial sale, as published at <http://www.nxp.com/profile/terms>, including those pertaining to warranty, intellectual property rights infringement and limitation of liability, unless explicitly otherwise agreed to in writing by NXP Semiconductors. In case of any inconsistency or conflict between information in this document and such terms and conditions, the latter will prevail.

No offer to sell or license — Nothing in this document may be interpreted or construed as an offer to sell products that is open for acceptance or the grant, conveyance or implication of any license under any copyrights, patents or other industrial or intellectual property rights.

15.4 Trademarks

Notice: All referenced brands, product names, service names and trademarks are the property of their respective owners.

16. Contact information

For more information, please visit: <http://www.nxp.com>

For sales office addresses, please send an email to: salesaddresses@nxp.com

17. Contents

1	General description	1
2	Features	1
3	Ordering information	1
4	Functional diagram	2
5	Pinning information	2
5.1	Pinning	2
5.2	Pin description	3
6	Functional description	3
7	Limiting values	4
8	Recommended operating conditions	4
9	Static characteristics	5
10	Dynamic characteristics	6
11	Waveforms	7
12	Package outline	9
13	Abbreviations	12
14	Revision history	12
15	Legal information	13
15.1	Data sheet status	13
15.2	Definitions	13
15.3	Disclaimers	13
15.4	Trademarks	13
16	Contact information	13
17	Contents	14



Please be aware that important notices concerning this document and the product(s) described herein, have been included in section 'Legal information'.

© NXP B.V. 2008.

All rights reserved.

For more information, please visit: <http://www.nxp.com>

For sales office addresses, please send an email to: salesaddresses@nxp.com

Date of release: 28 April 2008

Document identifier: 74AHC_AHCT00_4

X-ON Electronics

Largest Supplier of Electrical and Electronic Components

Click to view similar products for [Logic Gates](#) category:

Click to view products by [NXP](#) manufacturer:

Other Similar products are found below :

[5962-8769901BCA](#) [74HC85N](#) [NL17SG08P5T5G](#) [NL17SG32DFT2G](#) [NLU1G32AMUTCG](#) [NLV7SZ58DFT2G](#) [NLVHC1G08DFT1G](#)
[NLVVHC1G14DTT1G](#) [NLX2G08DMUTCG](#) [NLX2G08MUTCG](#) [MC74HCT20ADR2G](#) [091992B](#) [091993X](#) [093560G](#) [634701C](#) [634921A](#)
[NL17SG32P5T5G](#) [NL17SG86DFT2G](#) [NLU1G32CMUTCG](#) [NLV14001UBDR2G](#) [NLVVHC1G132DTT1G](#) [NLVVHC1G86DTT1G](#)
[NLX1G11AMUTCG](#) [NLX1G97MUTCG](#) [746427X](#) [74AUP1G17FW5-7](#) [74LS38](#) [74LVC1G08Z-7](#) [74LVC32ADTR2G](#) [74LVC1G125FW4-7](#)
[74LVC08ADTR2G](#) [MC74HCT20ADTR2G](#) [NLV14093BDTR2G](#) [NLV17SZ00DFT2G](#) [NLV17SZ02DFT2G](#) [NLV17SZ126DFT2G](#)
[NLV27WZ17DFT2G](#) [NLV74HC02ADR2G](#) [NLV74HC08ADR2G](#) [NLVVHC1GT32DFT1G](#) [74HC32S14-13](#) [74LS133](#) [74LVC1G32Z-7](#)
[M38510/30402BDA](#) [74LVC1G86Z-7](#) [74LVC2G08RA3-7](#) [M38510/06202BFA](#) [NLV74HC08ADTR2G](#) [NLV74HC14ADR2G](#)
[NLV74HC20ADR2G](#)