

P6SMB6.8AT3G Series, SZP6SMB6.8AT3G Series



Expertise Applied | Answers Delivered

Littelfuse.com

600 Watt Peak Power Zener Transient Voltage Suppressors

Unidirectional*

The SMB series is designed to protect voltage sensitive components from high voltage, high energy transients. They have excellent clamping capability, high surge capability, low zener impedance and fast response time. The SMB series is supplied in the Littelfuse exclusive, cost-effective, highly reliable package and is ideally suited for use in communication systems, automotive, numerical controls, process controls, medical equipment, business machines, power supplies and many other industrial/consumer applications.

Specification Features:

- Working Peak Reverse Voltage Range – 5.8 to 171 V
- Standard Zener Breakdown Voltage Range – 6.8 to 200 V
- Peak Power – 600 W @ 1 ms
- ESD Rating of Class 3 (> 16 kV) per Human Body Model
- Maximum Clamp Voltage @ Peak Pulse Current
- Low Leakage < 5 μ A Above 10 V
- UL 497B for Isolated Loop Circuit Protection
- Response Time is Typically < 1 ns
- SZ Prefix for Automotive and Other Applications Requiring Unique Site and Control Change Requirements; AEC-Q101 Qualified and PPAP Capable
- These Devices are Pb-Free and are RoHS Compliant

Mechanical Characteristics:

CASE: Void-free, transfer-molded, thermosetting plastic

FINISH: All external surfaces are corrosion resistant and leads are readily solderable

MAXIMUM CASE TEMPERATURE FOR SOLDERING PURPOSES:
260°C for 10 Seconds

LEADS: Modified L-Bend providing more contact area to bond pads

POLARITY: Cathode indicated by polarity band

MOUNTING POSITION: Any

PLASTIC SURFACE MOUNT ZENER OVERVOLTAGE TRANSIENT SUPPRESSORS 5.8–171 VOLTS 600 WATT PEAK POWER



SMB
CASE 403A
PLASTIC

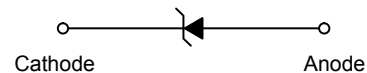

MARKING DIAGRAM

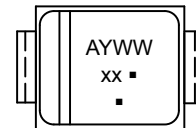

- A = Assembly Location
- Y = Year
- WW = Work Week
- xx = Device Code (Refer to page 3)
- = Pb-Free Package

(Note: Microdot may be in either location)

ORDERING INFORMATION

| Device | Package | Shipping |
|----------------|------------------|------------------------|
| P6SMBxxxAT3G | SMB (Pb-Free) | 2,500 / Tape & Reel |
| SZP6SMBxxxAT3G | SMB (Pb-Free) | 2,500 / Tape & Reel |

*Please see P6SMB11CAT3 to P6SMB91CAT3 for Bidirectional devices.

P6SMB6.8AT3G Series, SZP6SMB6.8AT3G Series

MAXIMUM RATINGS

| Rating | Symbol | Value | Unit |
|---|-----------------|-------------|----------------------------|
| Peak Power Dissipation (Note 1) @ $T_L = 25^\circ\text{C}$, Pulse Width = 1 ms | P_{PK} | 600 | W |
| DC Power Dissipation @ $T_L = 75^\circ\text{C}$ Measured Zero Lead Length (Note 2) Derate Above 75°C | P_D | 3.0 | W |
| Thermal Resistance from Junction-to-Lead | $R_{\theta JL}$ | 40 | $\text{mW}/^\circ\text{C}$ |
| DC Power Dissipation (Note 3) @ $T_A = 25^\circ\text{C}$ Derate Above 25°C | P_D | 0.55 | W |
| Thermal Resistance from Junction-to-Ambient | $R_{\theta JA}$ | 4.4 | $\text{mW}/^\circ\text{C}$ |
| Forward Surge Current (Note 4) @ $T_A = 25^\circ\text{C}$ | I_{FSM} | 226 | $^\circ\text{C}/\text{W}$ |
| Operating and Storage Temperature Range | T_J, T_{stg} | -65 to +150 | $^\circ\text{C}$ |

Stresses exceeding those listed in the Maximum Ratings table may damage the device. If any of these limits are exceeded, device functionality should not be assumed, damage may occur and reliability may be affected.

1. $10 \times 1000 \mu\text{s}$, non-repetitive
2. $1''$ square copper pad, FR-4 board
3. FR-4 board, using Littelfuse minimum recommended footprint, as shown in 403A case outline dimensions spec.
4. $1/2$ sine wave (or equivalent square wave), $PW = 8.3 \text{ ms}$, duty cycle = 4 pulses per minute maximum.

ELECTRICAL CHARACTERISTICS

($T_A = 25^\circ\text{C}$ unless otherwise noted, $V_F = 3.5 \text{ V Max. @ } I_F$
(Note 4) = 30 A, $V_F = 1.3 \text{ V Max. @ } I_F$ (Note 4) = 3 A) (Note 5)

| Symbol | Parameter |
|-----------------|---|
| I_{PP} | Maximum Reverse Peak Pulse Current |
| V_C | Clamping Voltage @ I_{PP} |
| V_{RWM} | Working Peak Reverse Voltage |
| I_R | Maximum Reverse Leakage Current @ V_{RWM} |
| V_{BR} | Breakdown Voltage @ I_T |
| I_T | Test Current |
| ΘV_{BR} | Maximum Temperature Coefficient of V_{BR} |
| I_F | Forward Current |
| V_F | Forward Voltage @ I_F |

5. $1/2$ sine wave or equivalent, $PW = 8.3 \text{ ms}$, non-repetitive duty cycle

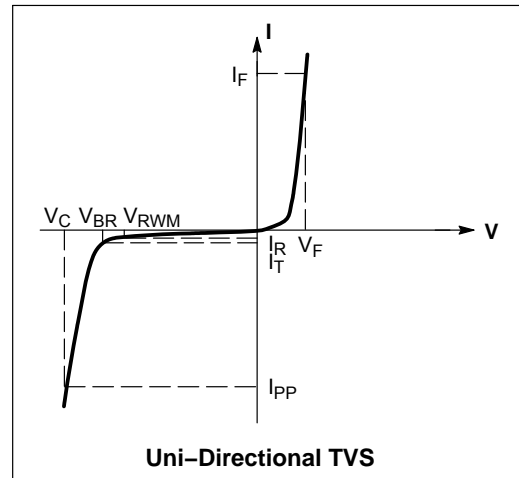

P6SMB6.8AT3G Series, SZP6SMB6.8AT3G Series

ELECTRICAL CHARACTERISTICS

| Device* | Device Marking | V _{RWM} (Note 6) V | I _R @ V _{RWM} μA | Breakdown Voltage | | | | V _C @ I _{PP} (Note 8) | | θV _{BR} %/°C | C _{typ} (Note 9) pF |
|--------------|----------------|-----------------------------------|--|----------------------------|-------|------|------------------|---|-----------------|--------------------------|------------------------------------|
| | | | | V _{BR} V (Note 7) | | | @ I _T | V _C | I _{PP} | | |
| | | | | Min | Nom | Max | mA | V | A | | |
| P6SMB6.8AT3G | 6V8A | 5.8 | 1000 | 6.45 | 6.8 | 7.14 | 10 | 10.5 | 57 | 0.057 | 2380 |
| P6SMB7.5AT3G | 7V5A | 6.4 | 500 | 7.13 | 7.51 | 7.88 | 10 | 11.3 | 53 | 0.061 | 2180 |
| P6SMB8.2AT3G | 8V2A | 7.02 | 200 | 7.79 | 8.2 | 8.61 | 10 | 12.1 | 50 | 0.065 | 2015 |
| P6SMB9.1AT3G | 9V1A | 7.78 | 50 | 8.65 | 9.1 | 9.55 | 1 | 13.4 | 45 | 0.068 | 1835 |
| P6SMB10AT3G | 10A | 8.55 | 10 | 9.5 | 10 | 10.5 | 1 | 14.5 | 41 | 0.073 | 1690 |
| P6SMB12AT3G | 12A | 10.2 | 5 | 11.4 | 12 | 12.6 | 1 | 16.7 | 36 | 0.078 | 1435 |
| P6SMB13AT3G | 13A | 11.1 | 5 | 12.4 | 13.05 | 13.7 | 1 | 18.2 | 33 | 0.081 | 1335 |
| P6SMB15AT3G | 15A | 12.8 | 5 | 14.3 | 15.05 | 15.8 | 1 | 21.2 | 28 | 0.084 | 1175 |
| P6SMB16AT3G | 16A | 13.6 | 5 | 15.2 | 16 | 16.8 | 1 | 22.5 | 27 | 0.086 | 1110 |
| P6SMB18AT3G | 18A | 15.3 | 5 | 17.1 | 18 | 18.9 | 1 | 25.2 | 24 | 0.088 | 1000 |
| P6SMB20AT3G | 20A | 17.1 | 5 | 19 | 20 | 21 | 1 | 27.7 | 22 | 0.09 | 910 |
| P6SMB22AT3G | 22A | 18.8 | 5 | 20.9 | 22 | 23.1 | 1 | 30.6 | 20 | 0.092 | 835 |
| P6SMB24AT3G | 24A | 20.5 | 5 | 22.8 | 24 | 25.2 | 1 | 33.2 | 18 | 0.094 | 775 |
| P6SMB27AT3G | 27A | 23.1 | 5 | 25.7 | 27.05 | 28.4 | 1 | 37.5 | 16 | 0.096 | 700 |
| P6SMB30AT3G | 30A | 25.6 | 5 | 28.5 | 30 | 31.5 | 1 | 41.4 | 14.4 | 0.097 | 635 |
| P6SMB33AT3G | 33A | 28.2 | 5 | 31.4 | 33.05 | 34.7 | 1 | 45.7 | 13.2 | 0.098 | 585 |
| P6SMB36AT3G | 36A | 30.8 | 5 | 34.2 | 36 | 37.8 | 1 | 49.9 | 12 | 0.099 | 540 |
| P6SMB39AT3G | 39A | 33.3 | 5 | 37.1 | 39.05 | 41 | 1 | 53.9 | 11.2 | 0.1 | 500 |
| P6SMB43AT3G | 43A | 36.8 | 5 | 40.9 | 43.05 | 45.2 | 1 | 59.3 | 10.1 | 0.101 | 460 |
| P6SMB47AT3G | 47A | 40.2 | 5 | 44.7 | 47.05 | 49.4 | 1 | 64.8 | 9.3 | 0.101 | 425 |
| P6SMB51AT3G | 51A | 43.6 | 5 | 48.5 | 51.05 | 53.6 | 1 | 70.1 | 8.6 | 0.102 | 395 |
| P6SMB56AT3G | 56A | 47.8 | 5 | 53.2 | 56 | 58.8 | 1 | 77 | 7.8 | 0.103 | 365 |
| P6SMB62AT3G | 62A | 53 | 5 | 58.9 | 62 | 65.1 | 1 | 85 | 7.1 | 0.104 | 335 |
| P6SMB68AT3G | 68A | 58.1 | 5 | 64.6 | 68 | 71.4 | 1 | 92 | 6.5 | 0.104 | 305 |
| P6SMB75AT3G | 75A | 64.1 | 5 | 71.3 | 75.05 | 78.8 | 1 | 103 | 5.8 | 0.105 | 280 |
| P6SMB91AT3G | 91A | 77.8 | 5 | 86.5 | 91 | 95.5 | 1 | 125 | 4.8 | 0.106 | 235 |
| P6SMB100AT3G | 100A | 85.5 | 5 | 95 | 100 | 105 | 1 | 137 | 4.4 | 0.106 | 215 |
| P6SMB120AT3G | 120A | 102 | 5 | 114 | 120 | 126 | 1 | 165 | 3.6 | 0.107 | 185 |
| P6SMB130AT3G | 130A | 111 | 5 | 124 | 130.5 | 137 | 1 | 179 | 3.3 | 0.107 | 170 |
| P6SMB150AT3G | 150A | 128 | 5 | 143 | 150.5 | 158 | 1 | 207 | 2.9 | 0.108 | 150 |
| P6SMB160AT3G | 160A | 136 | 5 | 152 | 160 | 168 | 1 | 219 | 2.7 | 0.108 | 140 |
| P6SMB180AT3G | 180A | 154 | 5 | 171 | 180 | 189 | 1 | 246 | 2.4 | 0.108 | 130 |
| P6SMB200AT3G | 200A | 171 | 5 | 190 | 200 | 210 | 1 | 274 | 2.2 | 0.108 | 115 |

6. A transient suppressor is normally selected according to the working peak reverse voltage (V_{RWM}), which should be equal to or greater than the DC or continuous peak operating voltage level.

7. V_{BR} measured at pulse test current I_T at an ambient temperature of 25°C.

8. Surge current waveform per Figure 2 and derate per Figure 3.

9. Bias Voltage = 0 V, F = 1 MHz, T_J = 25°C

* Include SZ-prefix devices where applicable.

P6SMB6.8AT3G Series, SZP6SMB6.8AT3G Series

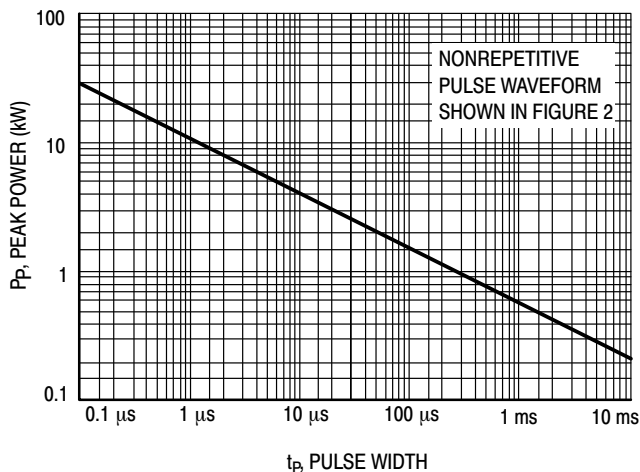

Figure 1. Pulse Rating Curve

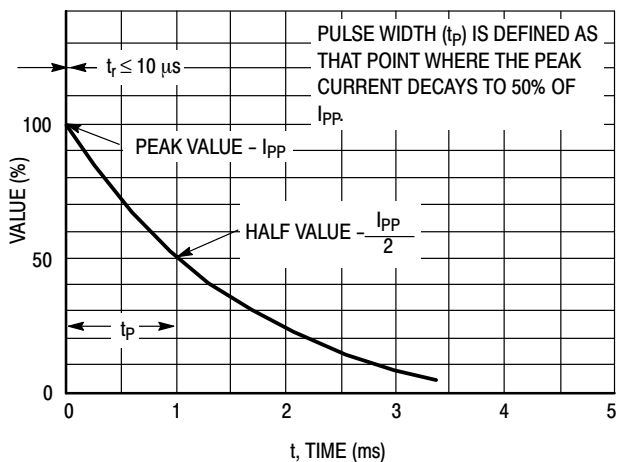

Figure 2. Pulse Waveform

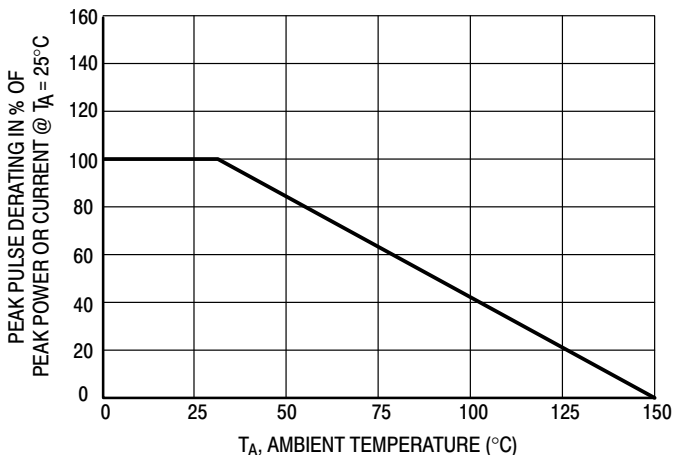

Figure 3. Pulse Derating Curve

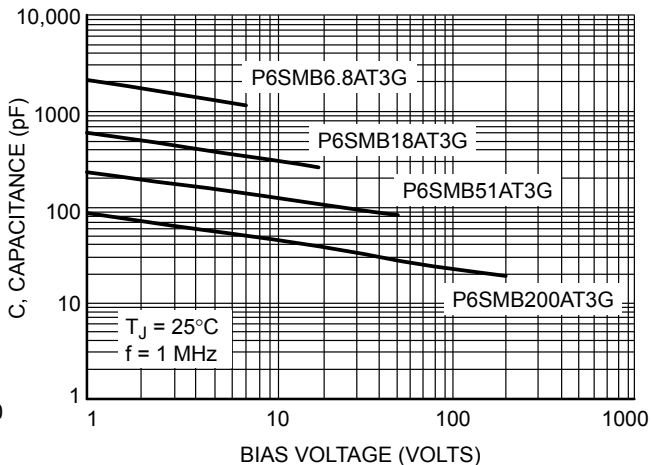
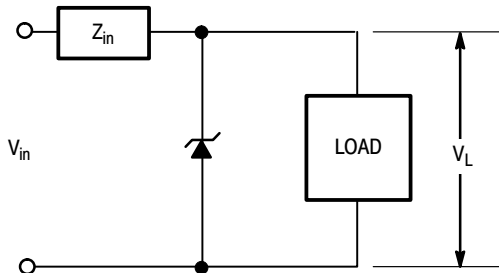

Figure 4. Typical Junction Capacitance vs. Bias Voltage

TYPICAL PROTECTION CIRCUIT



APPLICATION NOTES

Response Time

In most applications, the transient suppressor device is placed in parallel with the equipment or component to be protected. In this situation, there is a time delay associated with the capacitance of the device and an overshoot condition associated with the inductance of the device and the inductance of the connection method. The capacitive effect is of minor importance in the parallel protection scheme because it only produces a time delay in the transition from the operating voltage to the clamp voltage as shown in Figure 5.

The inductive effects in the device are due to actual turn-on time (time required for the device to go from zero current to full current) and lead inductance. This inductive effect produces an overshoot in the voltage across the equipment or component being protected as shown in Figure 6. Minimizing this overshoot is very important in the application, since the main purpose for adding a transient suppressor is to clamp voltage spikes. The SMB series have a very good response time, typically < 1 ns and negligible inductance. However, external inductive effects could produce unacceptable overshoot. Proper circuit layout,

minimum lead lengths and placing the suppressor device as close as possible to the equipment or components to be protected will minimize this overshoot.

Some input impedance represented by Z_{in} is essential to prevent overstress of the protection device. This impedance should be as high as possible, without restricting the circuit operation.

Duty Cycle Derating

The data of Figure 1 applies for non-repetitive conditions and at a lead temperature of 25°C. If the duty cycle increases, the peak power must be reduced as indicated by the curves of Figure 7. Average power must be derated as the lead or ambient temperature rises above 25°C. The average power derating curve normally given on data sheets may be normalized and used for this purpose.

At first glance the derating curves of Figure 7 appear to be in error as the 10 ms pulse has a higher derating factor than the 10 μs pulse. However, when the derating factor for a given pulse of Figure 7 is multiplied by the peak power value of Figure 1 for the same pulse, the results follow the expected trend.

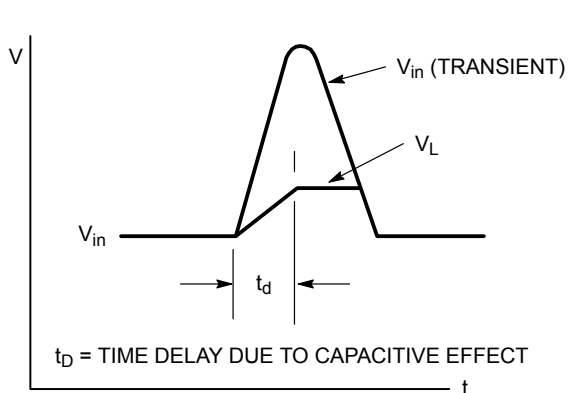

Figure 5.

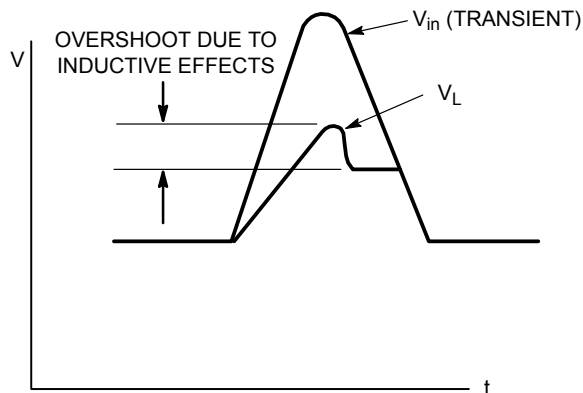

Figure 6.

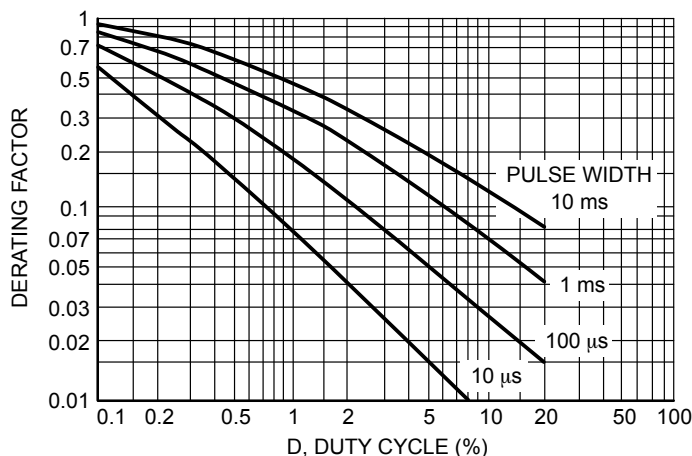

Figure 7. Typical Derating Factor for Duty Cycle

P6SMB6.8AT3G Series, SZP6SMB6.8AT3G Series

UL RECOGNITION

The entire series has *Underwriters Laboratory Recognition* for the classification of protectors (QVGQ2) under the UL standard for safety 497B and File #E128662. Many competitors only have one or two devices recognized or have recognition in a non-protective category. Some competitors have no recognition at all. With the UL497B recognition, our parts successfully passed several tests

including Strike Voltage Breakdown test, Endurance Conditioning, Temperature test, Dielectric Voltage-Withstand test, Discharge test and several more.

Whereas, some competitors have only passed a flammability test for the package material, we have been recognized for much more to be included in their Protector category.

P6SMB6.8AT3G Series, SZP6SMB6.8AT3G Series

PACKAGE DIMENSIONS

SMB
CASE 403A-03
ISSUE J

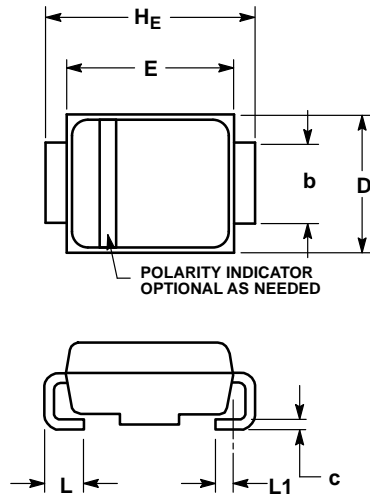

- NOTES:
1. DIMENSIONING AND TOLERANCING PER ANSI Y14.5M, 1982.
2. CONTROLLING DIMENSION: INCH.
3. DIMENSION b SHALL BE MEASURED WITHIN DIMENSION L1.

| DIM | MILLIMETERS | | | INCHES | | |
|-----|-------------|------|------|-----------|-------|-------|
| | MIN | NOM | MAX | MIN | NOM | MAX |
| A | 1.95 | 2.30 | 2.47 | 0.077 | 0.091 | 0.097 |
| A1 | 0.05 | 0.10 | 0.20 | 0.002 | 0.004 | 0.008 |
| b | 1.96 | 2.03 | 2.20 | 0.077 | 0.080 | 0.087 |
| c | 0.15 | 0.23 | 0.31 | 0.006 | 0.009 | 0.012 |
| D | 3.30 | 3.56 | 3.95 | 0.130 | 0.140 | 0.156 |
| E | 4.06 | 4.32 | 4.60 | 0.160 | 0.170 | 0.181 |
| HE | 5.21 | 5.44 | 5.60 | 0.205 | 0.214 | 0.220 |
| L | 0.76 | 1.02 | 1.60 | 0.030 | 0.040 | 0.063 |
| L1 | 0.51 REF | | | 0.020 REF | | |

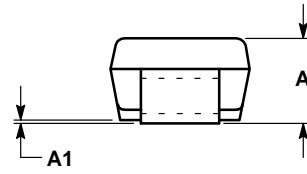

SOLDERING FOOTPRINT

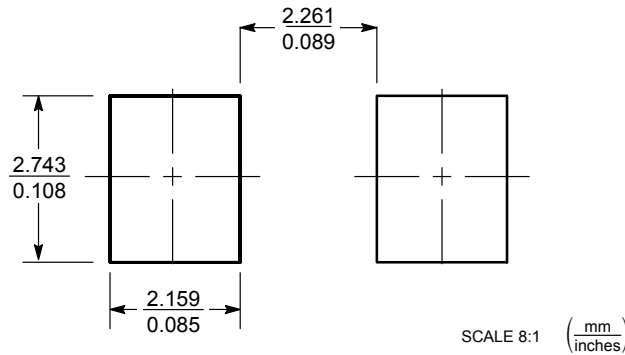

Littelfuse products are not designed for, and shall not be used for, any purpose (including, without limitation, automotive, military, aerospace, medical, life-saving, life-sustaining or nuclear facility applications, devices intended for surgical implant into the body, or any other application in which the failure or lack of desired operation of the product may result in personal injury, death, or property damage) other than those expressly set forth in applicable Littelfuse product documentation. Warranties granted by Littelfuse shall be deemed void for products used for any purpose not expressly set forth in applicable Littelfuse documentation. Littelfuse shall not be liable for any claims or damages arising out of products used in applications not expressly intended by Littelfuse as set forth in applicable Littelfuse documentation. The sale and use of Littelfuse products is subject to Littelfuse Terms and Conditions of Sale, unless otherwise agreed by Littelfuse.

X-ON Electronics

Largest Supplier of Electrical and Electronic Components

Click to view similar products for TVS Diodes - Transient Voltage Suppressors category:

Click to view products by ON Semiconductor manufacturer:

Other Similar products are found below :

[60KS200C](#) [D12V0H1U2WS-7](#) [PSR05-LF-T7](#) [DESD5V0U1BB-7](#) [P6KE39CA-TP](#) [JAN1N6461](#) [SMAJ440A-TP](#) [SMLJ30CA-TP](#)
[ESD0P8RFL E6327](#) [ESD101-B1-02ELS E6327](#) [ESD103-B1-02EL E6327](#) [ESD105-B1-02EL E6327](#) [ESD112-B1-02EL E6327](#)
[ESD119B1W01005E6327XTSA1](#) [ESD5V0L1B02VH6327XTSA1](#) [T1042NLT](#) [3.0SMCJ36A-F](#) [JANTX1N6126A](#) [JANTX1N6465](#)
[DESD5V0U1BL-7B](#) [ESD200-B1-CSP0201 E6327](#) [ESD203-B1-02EL E6327](#) [SM12-7](#) [SMF8.0A-TP](#) [SMLJ45CA-TP](#) [CEN955 W/DATA](#)
[P6KE15CA-TP](#) [ESD101-B1-02EL E6327](#) [P6SMBJ20CA](#) [JANTX1N6163A](#) [SR2835ESKG](#) [SA90CA](#) [SA130A](#) [SMLJ40CA-TP](#) [ESD110-B1-](#)
[02ELS E6327](#) [ESD205-B1-02ELS E6327](#) [ESD208-B1-02ELS E6327](#) [PTVS12VZ1USKNYL](#) [3.0SMCJ24A-13](#) [3.0SMCJ30A-13](#) [30KPA36A-](#)
[LF](#) [30KPA48CALF](#) [3.0SMCJ28A-13](#) [3.0SMCJ5.0A-13](#) [TVS4201MR6T1G](#) [VS10P15C-LF](#) [VTVS9V4ASMF-M3-08](#) [RSA30LTE25](#)
[1.5KE100CA-B](#) [1.5KE400C-B](#)