

DATA SHEET



PMEG2005AEV; PMEG3005AEV; PMEG4005AEV

Very low V_F MEGA Schottky barrier
rectifiers

**Very low V_F MEGA
Schottky barrier rectifiers**

**PMEG2005AEV; PMEG3005AEV;
PMEG4005AEV**

FEATURES

- Very low forward voltage
- High surge current
- Ultra small plastic SMD package.

APPLICATIONS

- Low voltage rectification
- High efficiency DC/DC conversion
- Voltage clamping
- Inverse polarity protection
- Low power consumption applications.

DESCRIPTION

Planar Maximum Efficiency General Application (MEGA) Schottky barrier rectifier with an integrated guard ring for stress protection, encapsulated in a SOT666 ultra small SMD plastic package.

QUICK REFERENCE DATA

SYMBOL	PARAMETER	MAX.	UNIT
I_F	forward current	0.5	A
V_R	reverse voltage		
	PMEG2005AEV	20	V
	PMEG3005AEV	30	V
	PMEG4005AEV	40	V

PINNING

PIN	DESCRIPTION
1	cathode
2	cathode
3	anode
4	anode
5	cathode
6	cathode

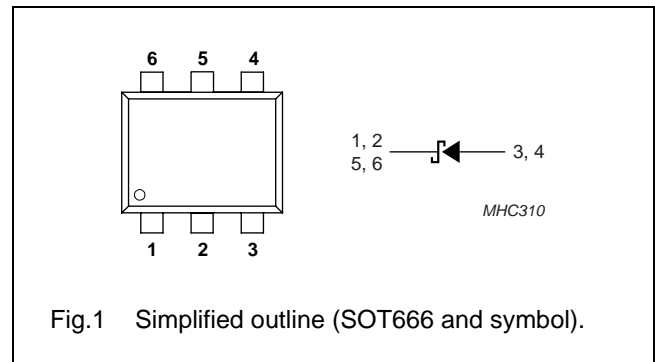

MARKING

TYPE NUMBER	MARKING CODE
PMEG2005AEV	G1
PMEG3005AEV	G2
PMEG4005AEV	G3

RELATED PRODUCTS

TYPE NUMBER	DESCRIPTION	FEATURE
PMEGxx05AEA	0.5 A; 20/30/40 V very low V_F MEGA Schottky rectifier	SOD323 (SC-76) package
PMEG2005EB	0.5 A; 20 V very low V_F MEGA Schottky rectifier	SOD523 (SC-79) package
PMEG2010EA	1 A; 20 V very low V_F MEGA Schottky rectifier	higher forward current

Very low V_F MEGA Schottky barrier rectifiers

PMEG2005AEV; PMEG3005AEV;
PMEG4005AEV

LIMITING VALUES

In accordance with the Absolute Maximum Rating System (IEC 60134).

SYMBOL	PARAMETER	CONDITIONS	MIN.	MAX.	UNIT
V_R	continuous reverse voltage				
	PMEG2005AEV		–	20	V
	PMEG3005AEV		–	30	V
	PMEG4005AEV		–	40	V
I_F	continuous forward current	note 1	–	0.5	A
I_{FRM}	repetitive peak forward current	$t_p \leq 1$ ms; $\delta \leq 0.5$; note 2	–	3.5	A
I_{FSM}	non-repetitive peak forward current	$t_p = 8$ ms; square wave; note 2	–	10	A
T_j	junction temperature	note 3	–	150	°C
T_{amb}	operating ambient temperature	note 3	–65	+150	°C
T_{stg}	storage temperature		–65	+150	°C

Notes

1. Refer to SOT666 standard mounting conditions.
2. Only valid if pins 3 and 4 are connected in parallel.
3. For Schottky barrier diodes thermal runaway has to be considered, as in some applications, the reverse power losses (P_R) are a significant part of the total power losses. Nomograms for determination of the reverse power losses P_R and $I_{F(AV)}$ rating will be available on request.

THERMAL CHARACTERISTICS

SYMBOL	PARAMETER	CONDITIONS	VALUE	UNIT
$R_{th\ j-a}$	thermal resistance from junction to ambient	in free air; notes 1 and 2	405	K/W
		in free air; notes 2 and 3	215	K/W
$R_{th\ j-s}$	thermal resistance from junction to soldering point	note 4	80	K/W

Notes

1. Refer to SOT666 standard mounting conditions.
2. For Schottky barrier diodes thermal runaway has to be considered, as in some applications the reverse power losses P_R are a significant part of the total power losses. Nomograms for determination of the reverse power losses P_R and $I_{F(AV)}$ rating will be available on request.
3. Device mounted on an FR4 printed-circuit board with copper clad 10 × 10 mm.
4. Solder point of cathode tab.

Very low V_F MEGA
Schottky barrier rectifiers

PMEG2005AEV; PMEG3005AEV;
PMEG4005AEV

ELECTRICAL CHARACTERISTICS

$T_{amb} = 25\text{ °C}$ unless otherwise specified.

SYMBOL	PARAMETER	CONDITIONS	PMEG2005AEV		PMEG3005AEV		PMEG4005AEV		UNIT
			TYP.	MAX.	TYP.	MAX.	TYP.	MAX.	
V_F	forward voltage	$I_F = 0.1\text{ mA}$	90	130	90	130	95	130	mV
		$I_F = 1\text{ mA}$	150	190	150	200	155	210	mV
		$I_F = 10\text{ mA}$	210	240	215	250	220	270	mV
		$I_F = 100\text{ mA}$	280	330	285	340	295	350	mV
		$I_F = 500\text{ mA}$	355	390	380	430	420	470	mV
I_R	continuous reverse current	$V_R = 10\text{ V}$; note 1	15	40	12	30	7	20	μA
		$V_R = 20\text{ V}$; note 1	40	200	–	–	–	–	μA
		$V_R = 30\text{ V}$; note 1	–	–	40	150	–	–	μA
		$V_R = 40\text{ V}$; note 1	–	–	–	–	30	100	μA
C_d	diode capacitance	$V_R = 1\text{ V}$; $f = 1\text{ MHz}$	66	80	55	70	43	50	pF

Note

1. Pulse test: $t_p \leq 300\text{ }\mu\text{s}$; $\delta \leq 0.02$.

Very low V_F MEGA
Schottky barrier rectifiers

PMEG2005AEV; PMEG3005AEV;
PMEG4005AEV

GRAPHICAL DATA

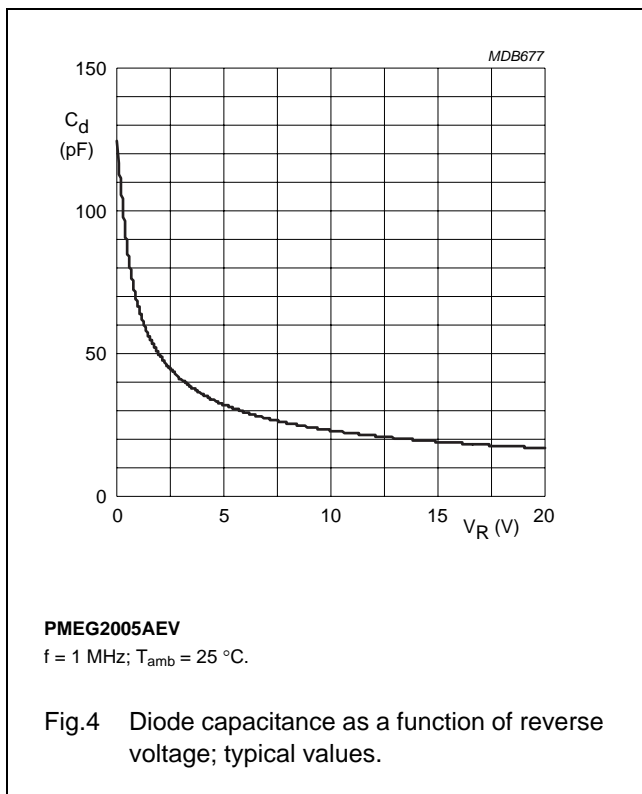
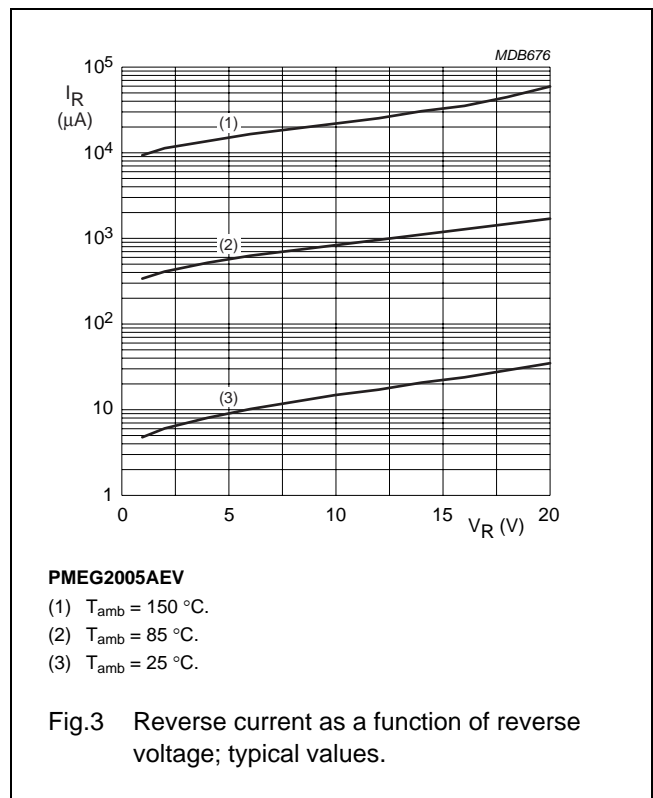
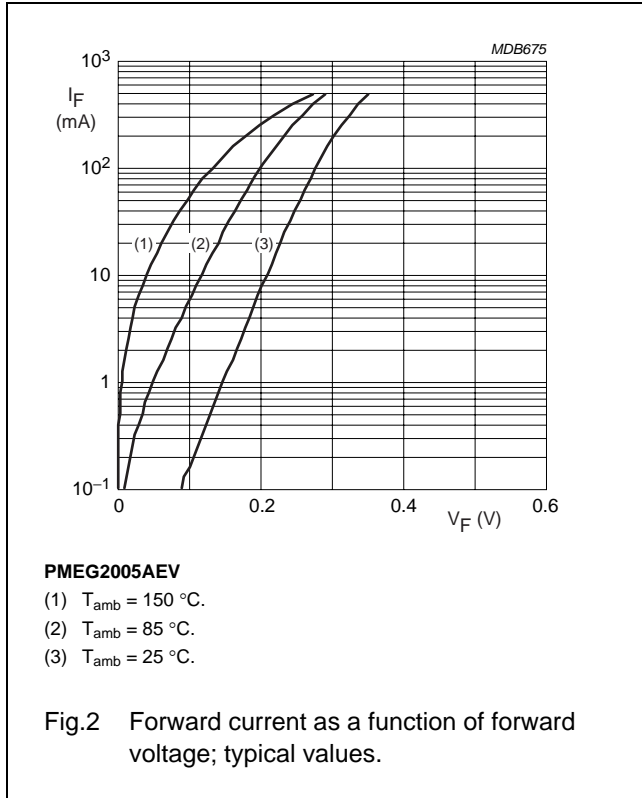

Very low V_F MEGA
Schottky barrier rectifiers

PMEG2005AEV; PMEG3005AEV;
PMEG4005AEV

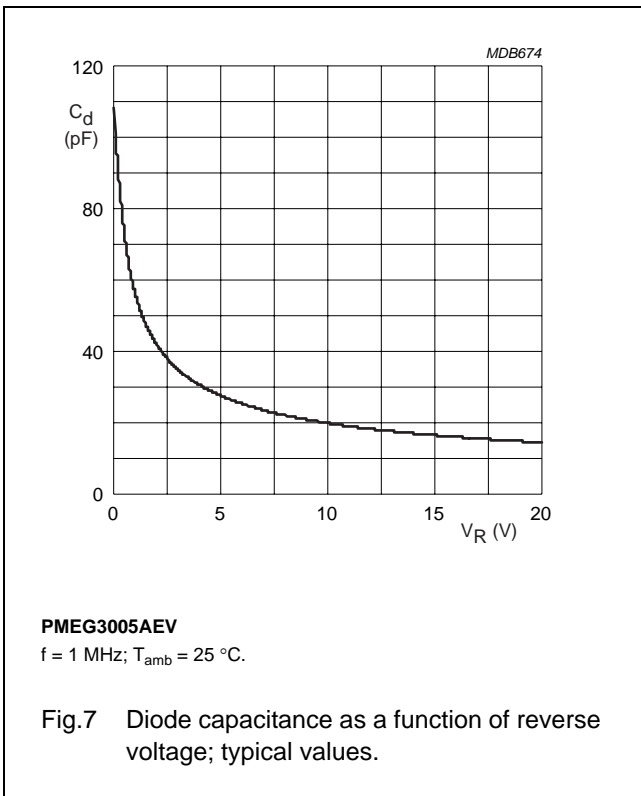
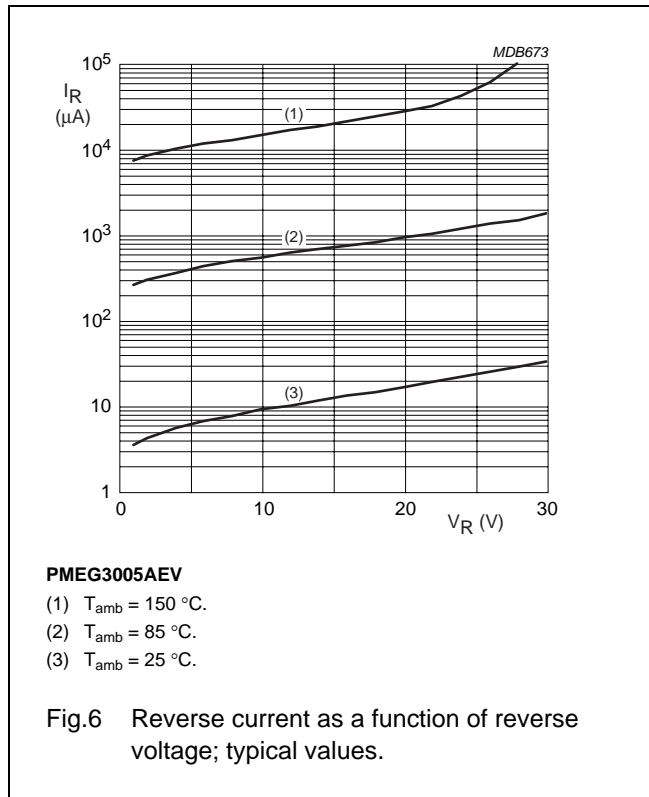
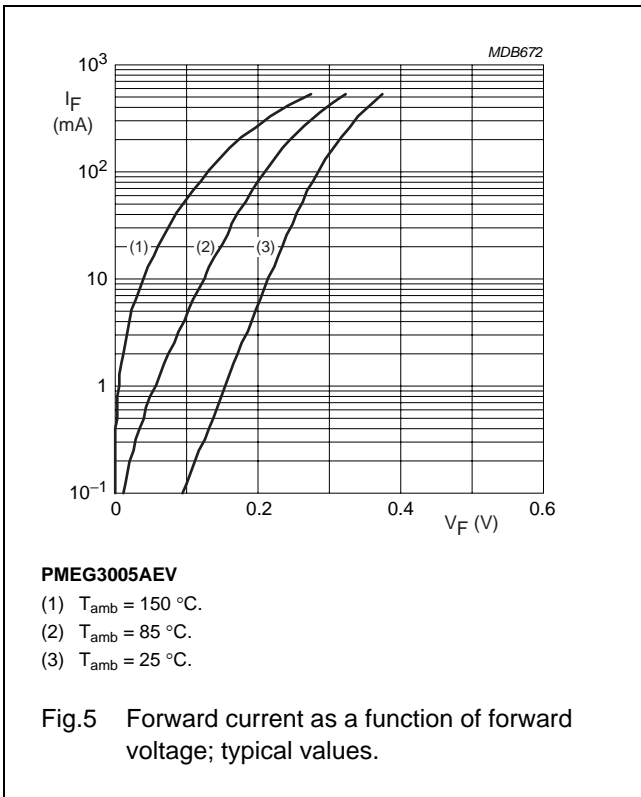

Very low V_F MEGA
Schottky barrier rectifiers

PMEG2005AEV; PMEG3005AEV;
PMEG4005AEV

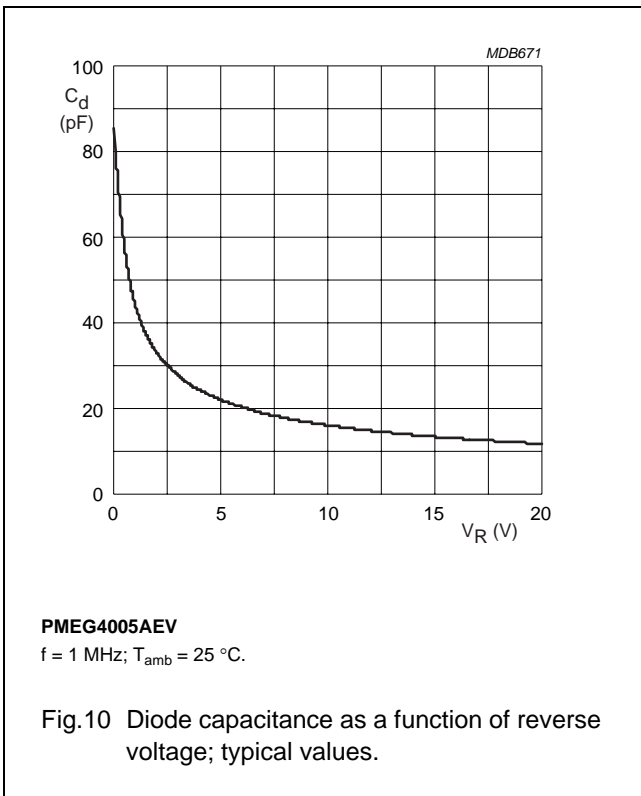
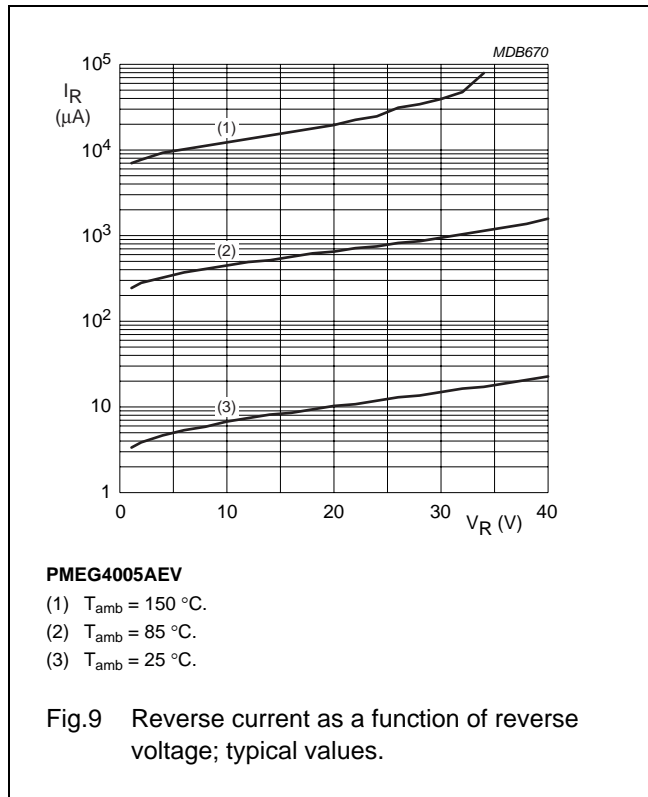
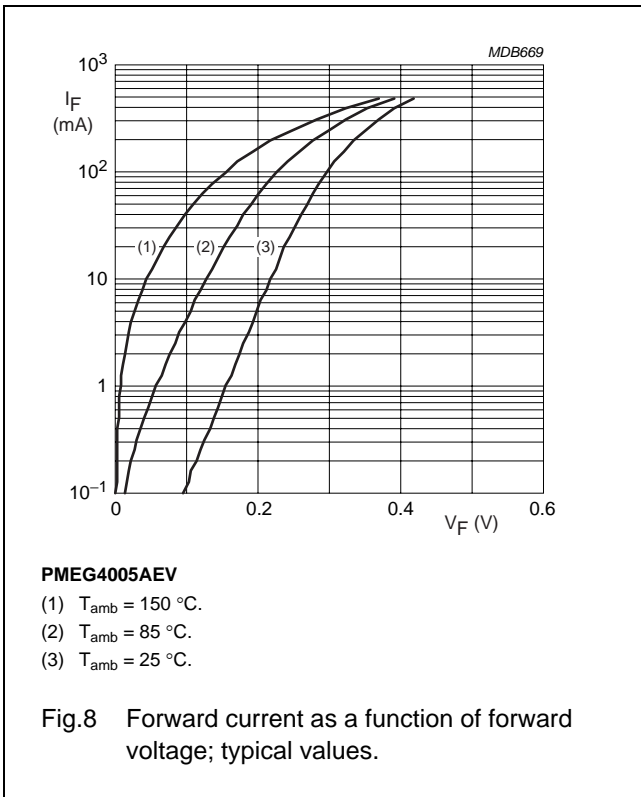

Very low V_F MEGA
Schottky barrier rectifiers

PMEG2005AEV; PMEG3005AEV;
PMEG4005AEV

PACKAGE OUTLINE

Plastic surface mounted package; 6 leads

SOT666

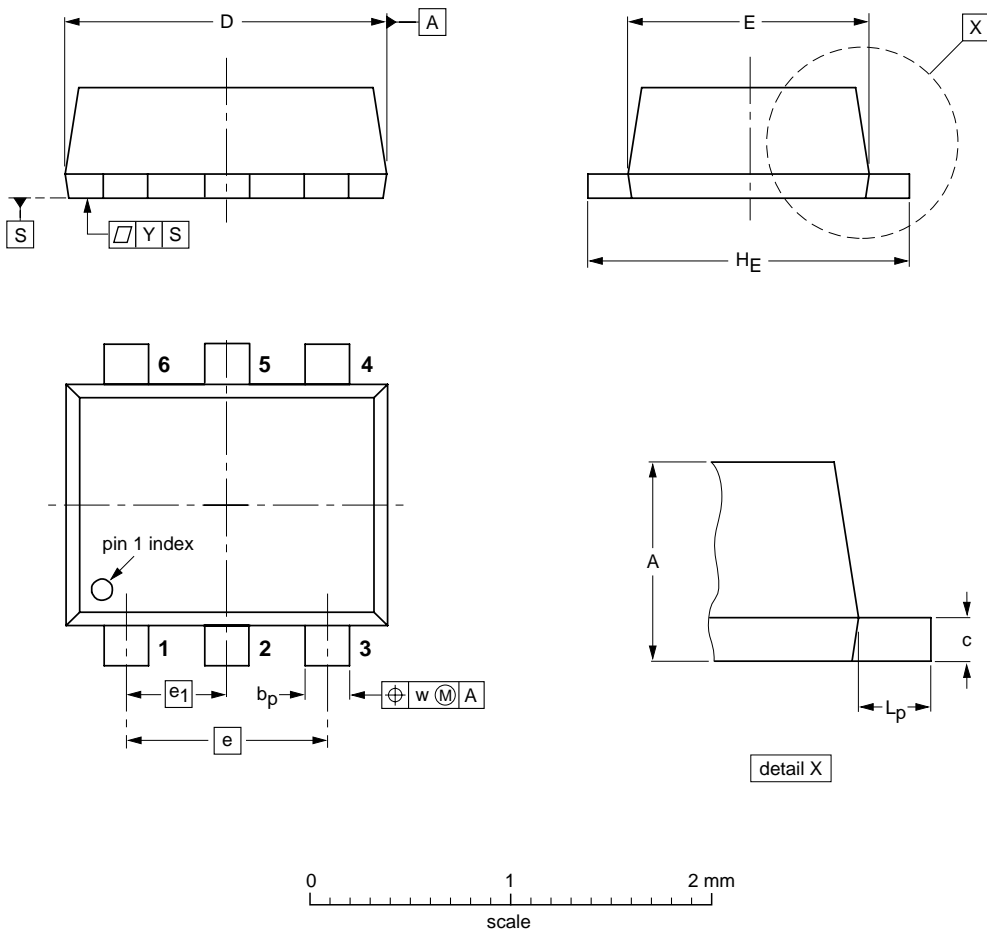

DIMENSIONS (mm are the original dimensions)

UNIT	A	b_p	c	D	E	e	e_1	H_E	L_p	w	y
mm	0.6 0.5	0.27 0.17	0.18 0.08	1.7 1.5	1.3 1.1	1.0	0.5	1.7 1.5	0.3 0.1	0.1	0.1

OUTLINE VERSION	REFERENCES			EUROPEAN PROJECTION	ISSUE DATE
	IEC	JEDEC	EIAJ		
SOT666					01-01-04 01-08-27

Very low V_F MEGA
Schottky barrier rectifiers

PMEG2005AEV; PMEG3005AEV;
PMEG4005AEV

DATA SHEET STATUS

DOCUMENT STATUS ⁽¹⁾	PRODUCT STATUS ⁽²⁾	DEFINITION
Objective data sheet	Development	This document contains data from the objective specification for product development.
Preliminary data sheet	Qualification	This document contains data from the preliminary specification.
Product data sheet	Production	This document contains the product specification.

Notes

1. Please consult the most recently issued document before initiating or completing a design.
2. The product status of device(s) described in this document may have changed since this document was published and may differ in case of multiple devices. The latest product status information is available on the Internet at URL <http://www.nxp.com>.

DISCLAIMERS

General — Information in this document is believed to be accurate and reliable. However, NXP Semiconductors does not give any representations or warranties, expressed or implied, as to the accuracy or completeness of such information and shall have no liability for the consequences of use of such information.

Right to make changes — NXP Semiconductors reserves the right to make changes to information published in this document, including without limitation specifications and product descriptions, at any time and without notice. This document supersedes and replaces all information supplied prior to the publication hereof.

Suitability for use — NXP Semiconductors products are not designed, authorized or warranted to be suitable for use in medical, military, aircraft, space or life support equipment, nor in applications where failure or malfunction of an NXP Semiconductors product can reasonably be expected to result in personal injury, death or severe property or environmental damage. NXP Semiconductors accepts no liability for inclusion and/or use of NXP Semiconductors products in such equipment or applications and therefore such inclusion and/or use is at the customer's own risk.

Applications — Applications that are described herein for any of these products are for illustrative purposes only. NXP Semiconductors makes no representation or warranty that such applications will be suitable for the specified use without further testing or modification.

Limiting values — Stress above one or more limiting values (as defined in the Absolute Maximum Ratings System of IEC 60134) may cause permanent damage to the device. Limiting values are stress ratings only and operation of the device at these or any other conditions

above those given in the Characteristics sections of this document is not implied. Exposure to limiting values for extended periods may affect device reliability.

Terms and conditions of sale — NXP Semiconductors products are sold subject to the general terms and conditions of commercial sale, as published at <http://www.nxp.com/profile/terms>, including those pertaining to warranty, intellectual property rights infringement and limitation of liability, unless explicitly otherwise agreed to in writing by NXP Semiconductors. In case of any inconsistency or conflict between information in this document and such terms and conditions, the latter will prevail.

No offer to sell or license — Nothing in this document may be interpreted or construed as an offer to sell products that is open for acceptance or the grant, conveyance or implication of any license under any copyrights, patents or other industrial or intellectual property rights.

Export control — This document as well as the item(s) described herein may be subject to export control regulations. Export might require a prior authorization from national authorities.

Quick reference data — The Quick reference data is an extract of the product data given in the Limiting values and Characteristics sections of this document, and as such is not complete, exhaustive or legally binding.

NXP Semiconductors

Customer notification

This data sheet was changed to reflect the new company name NXP Semiconductors. No changes were made to the content, except for the legal definitions and disclaimers.

Contact information

For additional information please visit: **<http://www.nxp.com>**

For sales offices addresses send e-mail to: **salesaddresses@nxp.com**

© NXP B.V. 2009

All rights are reserved. Reproduction in whole or in part is prohibited without the prior written consent of the copyright owner.

The information presented in this document does not form part of any quotation or contract, is believed to be accurate and reliable and may be changed without notice. No liability will be accepted by the publisher for any consequence of its use. Publication thereof does not convey nor imply any license under patent- or other industrial or intellectual property rights.

Printed in The Netherlands

613514/01/pp10

Date of release: 2003 Aug 20

Document order number: 9397 750 11687



X-ON Electronics

Largest Supplier of Electrical and Electronic Components

Click to view similar products for [Schottky Diodes & Rectifiers](#) category:

Click to view products by [NXP](#) manufacturer:

Other Similar products are found below :

[CUS06\(TE85L,Q,M\)](#) [D1FH3-5063](#) [MBR0530L-TP](#) [MBR10100CT-BP](#) [MBR30H100MFST1G](#) [MMBD301M3T5G](#) [PMAD1103-LF](#)
[PMAD1108-LF](#) [RB160M-50TR](#) [RB520S-30](#) [RB551V-30](#) [DD350N18K](#) [DZ435N40K](#) [DZ600N16K](#) [BAS16E6433HTMA1](#) [BAS 3010S-](#)
[02LRH E6327](#) [BAT 54-02LRH E6327](#) [IDL02G65C5XUMA1](#) [NSR05F40QNXT5G](#) [JANS1N6640](#) [SB07-03C-TB-H](#) [SB1003M3-TL-W](#)
[SBAT54CWT1G](#) [SBM30-03-TR-E](#) [SK32A-LTP](#) [SK33A-TP](#) [SK34A-TP](#) [SK34B-TP](#) [SMD1200PL-TP](#) [ACDBN160-HF](#) [SS3003CH-TL-E](#)
[STPS30S45CW](#) [PDS3100Q-7](#) [GA01SHT18](#) [CRS10I30A\(TE85L,QM\)](#) [MBR1240MFST1G](#) [MBRB30H30CT-1G](#) [BAS28E6433HTMA1](#) [BAS](#)
[70-02L E6327](#) [HSB123JTR-E](#) [JANTX1N5712-1](#) [VS-STPS40L45CW-N3](#) [DD350N12K](#) [SB007-03C-TB-E](#) [SB10015M-TL-E](#) [SB1003M3-TL-](#)
[E](#) [SK110-LTP](#) [SK154-TP](#) [SK32A-TP](#) [SK33B-TP](#)