

General Purpose EMI Filter with High Attenuation Performance



- | Rated currents from 1 to 30 A
- | High performance filter attenuation
- | High differential-mode attenuation
- | Optional medical versions (B type)
- | Optional safety versions (A type)
- | Optional overvoltage protection (Z type)



Performance indicators

Attenuation performance



Rated current [A]

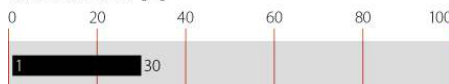

Technical specifications

| | |
|--|---|
| Operating voltage | 110/250 VAC, 50/60 Hz |
| Operating frequency | dc to 400 Hz |
| Rated currents | 1 to 30 A @ 40 °C max. |
| High potential test voltage | P → PE 2000 VAC for 2 sec (standard types) P → N 1100 VDC for 2 sec P → PE 2500 VAC for 2 sec (B types) |
| Temperature range (operation and storage) | -25 °C to +100 °C (25/100/21) |
| Design corresponding to | UL 1283, CSA 22.2 No. 8 1986, IEC/EN 60939 |
| Flammability corresponding to | UL 94 V-2 or better |
| Surge pulse protection (optional) | 2kV, IEC 61000-4-5 |
| MTBF @ 40°C/230V (Mil-HB-217F) | 2,200,000 hours (1 to 10 A types) 1,200,000 hours (12 to 30 A types) |

Approvals



Features and benefits

- | FN 2030 filters are designed for easy and fast chassis mounting
- | The FN 2030 filters are also available as B versions with no Y-capacitors for medical applications as well as A versions with low capacitance for safety critical applications with a requirement for low leakage currents
- | All filters provide an exceptional conducted attenuation performance, based on chokes with high permeable core material and excellent thermal behavior
- | The higher inductivity versus amperage offers increased attenuation performance with same form factor compared to FN 2010 and FN 2020 filter series
- | All FN 2030 filters can be delivered with optional surge pulse protection. FN 2030 filters are also available as two-stage filters (FN 2090 series) for very noisy environment
- | Various terminal options allow you to select the desired connection style



Typical application

- | Electrical and electronic equipment
- | Consumer goods
- | Household equipment
- | Medical equipment
- | Electronic data processing equipment
- | Office automation and datacom equipment
- | Various noisy applications requiring high filter performance

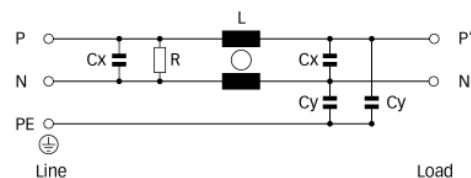
Typical electrical schematic



Filter selection table

| Filter* | Rated current | Leakage current** | Inductance | Capacitance | | Resistance | Input/Output connections | | | Weight |
|----------------|-----------------|-------------------|------------|-------------|------|------------|---|---|---|--------|
| | @ 40 °C (25 °C) | @ 230 VAC/50 Hz | L | Cx | Cy | R |  |  |  | |
| | [A] | [mA] | [mH] | [µF] | [nF] | [kΩ] | | | | [g] |
| FN 2030-1-.. | 1 (1.1) | 0.34 | 20 | 0.22 | 2.2 | 1000 | -06 | -07 | | 58 |
| FN 2030-3-.. | 3 (3.4) | 0.52 | 14 | 0.33 | 3.3 | 1000 | -06 | -07 | | 87 |
| FN 2030-4-.. | 4 (4.5) | 0.52 | 14 | 0.33 | 3.3 | 1000 | -06 | -07 | | 92 |
| FN 2030-6-.. | 6 (6.7) | 0.73 | 8 | 0.47 | 4.7 | 680 | -06 | -07 | | 100 |
| FN 2030-8-.. | 8 (8.9) | 0.73 | 8 | 0.47 | 4.7 | 680 | -06 | -07 | | 170 |
| FN 2030-10-.. | 10 (11.2) | 0.73 | 8 | 0.47 | 4.7 | 680 | -06 | -07 | | 196 |
| FN 2030-12-.. | 12 (13.4) | 0.87 | 4 | 1.0 | 10 | 330 | -06 | -07 | | 185 |
| FN 2030-16-.. | 16 (17.9) | 0.87 | 4 | 1.0 | 10 | 330 | -06 | -07 | | 225 |
| FN 2030-20-.. | 20 (22.4) | 0.87 | 4 | 1.0 | 10 | 330 | -06 | | -08 | 285 |
| FN 2030-30-08 | 30 (33.5) | 0.87 | 2 | 1.0 | 10 | 330 | | | -08 | 326 |
| FN 2030A-1-.. | 1 (1.1) | 0.074 | 20 | 0.22 | 0.47 | 1000 | -06 | -07 | | 58 |
| FN 2030A-3-.. | 3 (3.4) | 0.074 | 14 | 0.33 | 0.47 | 1000 | -06 | -07 | | 87 |
| FN 2030A-4-.. | 4 (4.5) | 0.074 | 14 | 0.33 | 0.47 | 1000 | -06 | -07 | | 92 |
| FN 2030A-6-.. | 6 (6.7) | 0.074 | 8 | 0.47 | 0.47 | 680 | -06 | -07 | | 100 |
| FN 2030A-8-.. | 8 (8.9) | 0.074 | 8 | 0.47 | 0.47 | 680 | -06 | -07 | | 170 |
| FN 2030A-10-.. | 10 (11.2) | 0.074 | 8 | 0.47 | 0.47 | 680 | -06 | -07 | | 196 |
| FN 2030A-12-.. | 12 (13.4) | 0.074 | 4 | 1.0 | 0.47 | 330 | -06 | -07 | | 185 |
| FN 2030A-16-.. | 16 (17.9) | 0.074 | 4 | 1.0 | 0.47 | 330 | -06 | -07 | | 225 |
| FN 2030A-20-.. | 20 (22.4) | 0.074 | 4 | 1.0 | 0.47 | 330 | -06 | | -08 | 285 |
| FN 2030A-30-08 | 30 (33.5) | 0.074 | 2 | 1.0 | 0.47 | 330 | | | -08 | 326 |
| FN 2030B-1-.. | 1 (1.1) | 0.002 | 20 | 0.22 | | 1000 | -06 | -07 | | 58 |
| FN 2030B-3-.. | 3 (3.4) | 0.002 | 14 | 0.33 | | 1000 | -06 | -07 | | 87 |
| FN 2030B-4-.. | 4 (4.5) | 0.002 | 14 | 0.33 | | 1000 | -06 | -07 | | 92 |
| FN 2030B-6-.. | 6 (6.7) | 0.002 | 8 | 0.47 | | 680 | -06 | -07 | | 100 |
| FN 2030B-8-.. | 8 (8.9) | 0.002 | 8 | 0.47 | | 680 | -06 | -07 | | 170 |
| FN 2030B-10-.. | 10 (11.2) | 0.002 | 8.45 | 0.47 | | 680 | -06 | -07 | | 196 |
| FN 2030B-12-.. | 12 (13.4) | 0.002 | 4 | 1.0 | | 330 | -06 | -07 | | 185 |
| FN 2030B-16-.. | 16 (17.9) | 0.002 | 4 | 1.0 | | 330 | -06 | -07 | | 225 |
| FN 2030B-20-.. | 20 (22.4) | 0.002 | 4 | 1.0 | | 330 | -06 | | -08 | 285 |
| FN 2030B-30-08 | 30 (33.5) | 0.002 | 2 | 1.0 | | 330 | | | -08 | 326 |

* To compile a complete part number, please replace the .. with the required I/O connection style. For surge pulse protection, please add Z (e.g. FN 2030Z-10-06, FN 2030BZ-20-08).

** Maximum leakage under normal operating conditions. Note: if the neutral line is interrupted, worst case leakage could reach twice this level.

Typical filter attenuation

Per CISPR 17; A = 50 Ω/50 Ω sym; B = 50 Ω/50 Ω asym; C = 0.1 Ω/100 Ω sym; D = 100 Ω/0.1 Ω sym

1 to 4 A types

6 to 10 A types

12 to 20 A types

30 A types

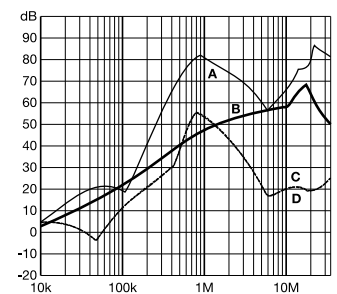
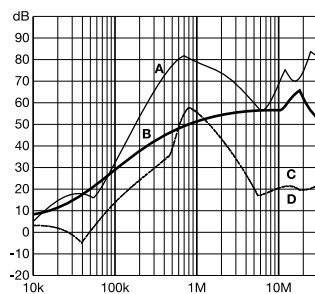
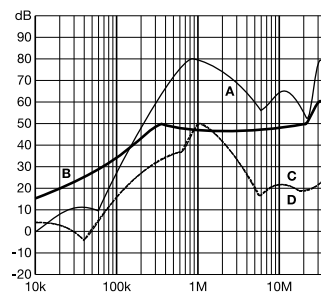
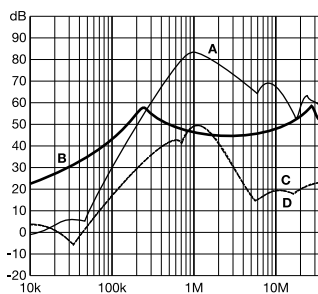

Mechanical data

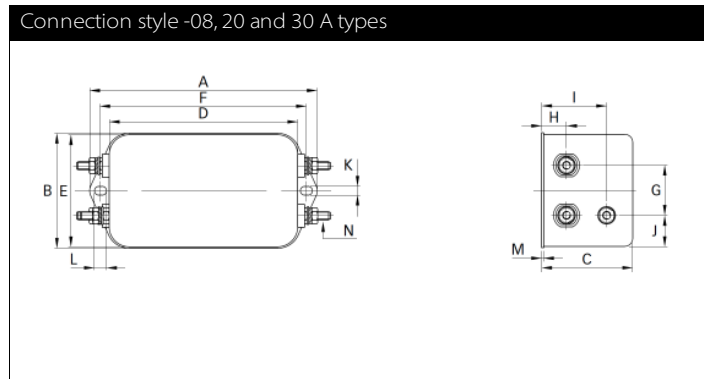
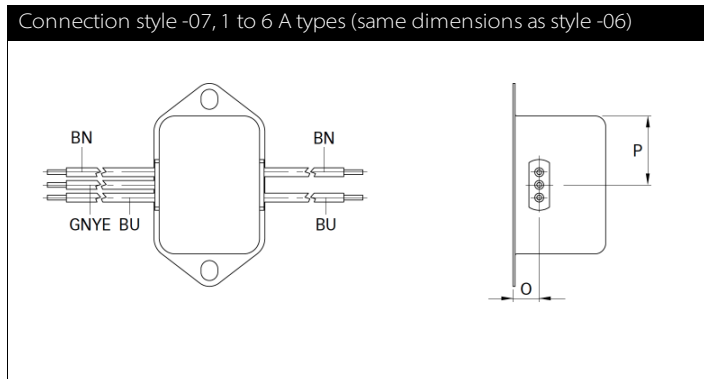
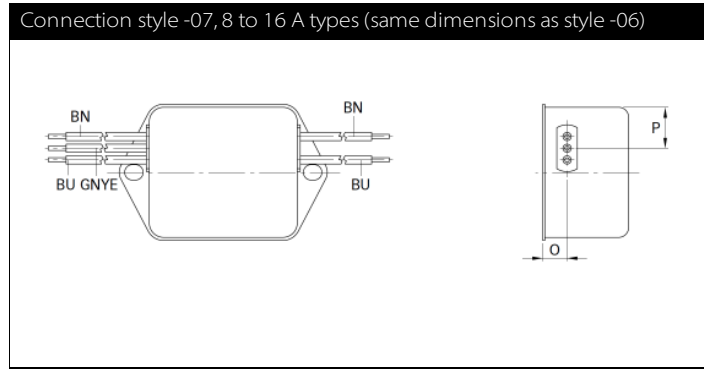
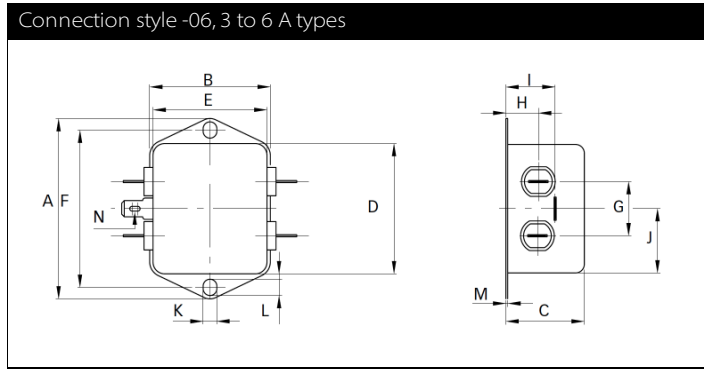
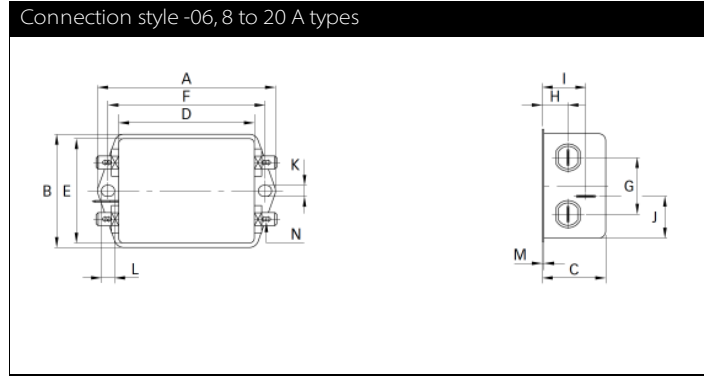
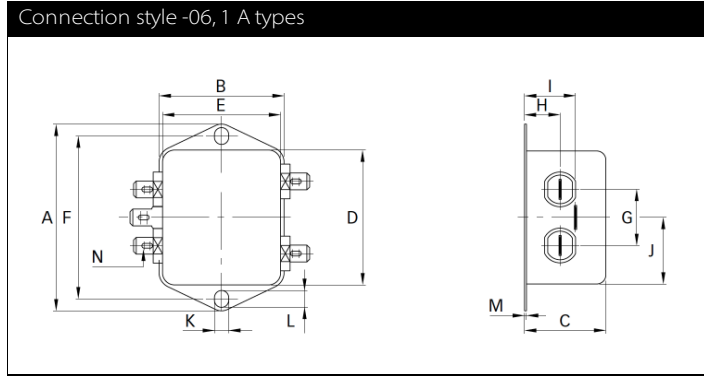

Dimensions

| | 1 A | 3 A | 4 A | 6 A | 8 A | 10 A | 12 A | 16 A | 20 A | 30 A | Tolerances |
|-----------------------------|-----------|-----------|-----------|-----------|-----------|-----------|-----------|-----------|-----------|-----------|------------|
| A | 64 | 71 | 71 | 71 | 85 | 85 | 85 | 85 | 85 | 85 | ±0.5 |
| B | 35 | 46.6 | 46.6 | 46.6 | 54 | 54 | 54 | 54 | 54 | 54 | ±0.5 |
| C | 24.3 | 22.3 | 22.3 | 22.3 | 30.3 | 30.3 | 30.3 | 40.3 | 40.3 | 40.3 | ±0.5 |
| D | 43.5 | 50.5 | 50.5 | 50.5 | 64.8 | 64.8 | 64.8 | 64.8 | 64.8 | 64.8 | ±0.5 |
| E | 32.5 | 44.5 | 44.5 | 44.5 | 49.8 | 49.8 | 49.8 | 49.8 | 49.8 | 49.8 | ±0.5 |
| F | 54 | 61 | 61 | 61 | 75 | 75 | 75 | 75 | 75 | 75 | ±0.3 |
| G | 21 | 21 | 21 | 21 | 27 | 27 | 27 | 27 | 27 | 27 | ±0.2 |
| H | 9.3 | 10.8 | 10.8 | 10.8 | 12.3 | 12.3 | 12.3 | 12.3 | 12.3 | 12.3 | ±0.5 |
| I | 15.3 | 16.8 | 16.8 | 16.8 | 20.8 | 20.8 | 20.8 | 29.8 | 29.8 | 29.8 | ±0.5 |
| J | 21.8 | 25.25 | 25.25 | 25.25 | 19.9 | 19.9 | 19.9 | 11.4 | 11.4 | 11.4 | ±0.5 |
| K | 5.3 | 5.3 | 5.3 | 5.3 | 5.3 | 5.3 | 5.3 | 5.3 | 5.3 | 5.3 | |
| L | 6.3 | 6.3 | 6.3 | 6.3 | 6.3 | 6.3 | 6.3 | 6.3 | 6.3 | 6.3 | |
| M | 0.7 | 0.7 | 0.7 | 0.7 | 0.7 | 0.7 | 0.7 | 0.7 | 0.7 | 0.7 | |
| Connection style -06 | | | | | | | | | | | |
| N | 6.3 x 0.8 | 6.3 x 0.8 | 6.3 x 0.8 | 6.3 x 0.8 | 6.3 x 0.8 | 6.3 x 0.8 | 6.3 x 0.8 | 6.3 x 0.8 | 6.3 x 0.8 | 6.3 x 0.8 | |
| Connection style -07 | | | | | | | | | | | |
| O | 8.3 | 8.3 | 8.3 | 8.3 | 8.3 | 8.3 | 8.3 | 8.3 | 8.3 | 8.3 | ±0.5 |
| P | 21.8 | 14 | 14 | 14 | 14.9 | 14.9 | 14.9 | 14.9 | 14.9 | 14.9 | ±0.5 |
| AWG type wire | AWG 20 | AWG 20 | AWG 20 | AWG 18 | AWG 18 | AWG 18 | AWG 16 | AWG 16 | AWG 16 | AWG 16 | |
| Wire length | 140 | 140 | 140 | 140 | 140 | 140 | 140 | 140 | 140 | 140 | |
| Connection style -08 | | | | | | | | | | | |
| N | | | | | | | | | M4 | M4 | |

All dimensions in mm; 1 inch = 25.4 mm
Tolerances according: ISO 2768-m / EN 22768-m



Headquarters, global innovation and development center

Switzerland

Schaffner Group

Nordstrasse 11
4542 Luterbach
T +41 32 6816 626
F +41 32 6816 630
info@schaffner.com
<http://www.schaffner.com>



Sales and application centers

China

Schaffner EMC Ltd. Shanghai

T20-3, No 565 Chuangye Road
Pudong New Area
201201 Shanghai
T +86 21 3813 9500
F +86 21 3813 9501 / 02
cschina@schaffner.com
<http://www.schaffner.com.cn/>

Finland

Schaffner Oy

Sauvonrinne 19 H
08500 Lohja
T +358 19 35 72 71
finlandsales@schaffner.com

France

Schaffner EMC S.A.S.

112 Quai de Bezons
Boîte postale 133
95100 Argenteuil
T +33 1 34 34 30 60
F +33 1 39 47 02 28
francesales@schaffner.com

Germany

Schaffner Deutschland GmbH

Schoemperlenstrasse 12B
76185 Karlsruhe
T +49 721 56910
F +49 721 569110
germanysales@schaffner.com

Italy

Schaffner EMC S.r.l.

Via Galileo Galilei 47
20092 Cinisello Balsamo (MI)
T +39 02 66 04 30 45 /47
F +39 02 61 23 943
italysales@schaffner.com

Japan

Schaffner EMC K.K.

1-32-12, Kamiyama, Setagaya-ku
7F Mitsui-seimei Sangenjaya Bldg.
154-0011 Tokyo
T +81 3 5712 3650
F +81 3 5712 3651
japansales@schaffner.com
<http://www.schaffner.jp>

Singapore

Schaffner EMC Pte Ltd.

Blk 3015A Ubi Road 1
05-09 Kampong Ubi Industrial Estate
408705 Singapore
T +65 6377 3283
F +65 6377 3281
singaporesales@schaffner.com

Spain

Schaffner EMC España

Calle Caléndula 93, Miniparc III, Edificio E,
Alcobendas
Miniparc III, Edificio E
El Soto de la Moraleja
Alcobendas
28109 Madrid
M +34 618 176 133
T +34 917 912 900
F +34 917 912 901
spainsales@schaffner.com

Sweden

Schaffner EMC AB

Turebergstorg 1, 6
19147 Sollentuna
T +46 8 5792 1121 / 22
F +46 8 92 96 90
swedensales@schaffner.com

Switzerland

Schaffner EMV AG

Nordstrasse 11
4542 Luterbach
T +41 32 681 66 26
F +41 32 681 66 41
switzerlandsales@schaffner.com

Taiwan R.O.C.

Schaffner EMV Ltd.

6 Floor, No. 413
Rui Guang Road
114 Neihu District Taipei City
T +886 2 87525050
F +886 2 87518086
taiwansales@schaffner.com

Thailand

Schaffner EMC Co. Ltd.

Northern Region Industrial Estate
67 Moo 4 Tambon Ban Klang
Amphur Muang P.O. Box 14
51000 Lamphun
T +66 53 58 11 04
F +66 53 58 10 19
thailandsales@schaffner.com

UK

Schaffner Ltd.

5 Ashville Way
Molly Millars Lane
Wokingham
RG41 2PL Berkshire
T +44 118 9770070
F +44 118 9792969
uksales@schaffner.com
<http://www.schaffner.uk.com>

USA

Schaffner EMC Inc.

52 Mayfield Avenue
08837 Edison, New Jersey
T +1 800 367 5566
T +1 732 225 9533
F +1 732 225 4789
usasales@schaffner.com
<http://www.schaffner.com/us>

Schaffner MTC LLC

6722 Thirlane Road
24019 Roanoke, Virginia
T +1 276 228 7943
F +1 276 228 7953
<http://www.schaffner-mtc.com>

Schaffner Trencos LLC

2550 Brookpark Road
44134 Cleveland, Ohio
T +1 216 741 5282
F +1 216 741 4860
<http://schaffner-trencos.com>

To find your local partner within Schaffner's global network: www.schaffner.com

© 2015 Schaffner Group

The content of this document has been carefully checked and understood. However, neither Schaffner nor its subsidiaries assume any liability whatsoever for any errors or inaccuracies of this document and the consequences thereof. Published specifications are subject to change without notice. Product suitability for any area of application must ultimately be determined by the customer. In all cases, products must never be operated outside their published specifications. Schaffner does not guarantee the availability of all published products. This disclaimer shall be governed by substantive Swiss law and resulting disputes shall be settled by the courts at the place of business of Schaffner Holding AG. Latest publications and a complete disclaimer can be downloaded from the Schaffner website. All trademarks recognized.

X-ON Electronics

Largest Supplier of Electrical and Electronic Components

Click to view similar products for [Power Line Filters](#) category:

Click to view products by [Schaffner](#) manufacturer:

Other Similar products are found below :

[5B1](#) [6609019-3](#) [6609026-5](#) [6609030-6](#) [6609063-2](#) [6609973-2](#) [7-1609090-5](#) [F1500CA06](#) [F7382Z](#) [F7863Z](#) [FAHAV3100ZC000](#) [806276](#)
[FN2020B-1-06](#) [FN2080B-10-06](#) [FN2090A-1-06](#) [FN2410H-32-33](#) [FN2410H-80-34](#) [FN2412H-16-44](#) [FN406B-0.5-02](#) [FN420-1-13](#) [FP144](#) [8-](#)
[6609089-0](#) [12-MMB-030-11-D](#) [B84144A90R120](#) [20B1](#) [RSEL-2001A](#) [2B1](#) [LP183](#) [1-6609070-1](#) [F1500CA10](#) [1B1](#) [FN2020A-10-06](#)
[FN2020B-3-06](#) [FN2060A-3-06](#) [FN2070A-16-06](#) [FN2070B-16-08](#) [FN2090B-12-06](#) [FN2090Z-1-06](#) [FN2410H-25-33](#) [FN2410H-60-34](#)
[FN2410H-8-44](#) [FN2412H-25-33](#) [FN2412H-8-44](#) [FN610R-3-06](#) [20EHZ7](#) [20K1](#) [30B6](#) [30BCF10R](#) [3K1](#) [4-6609089-0](#)