

**Tooling Guide for
Aerospace Wiring Systems**



60
Celebrating 60 Years!

An ISO 9001:2008
& AS9100:2004
Registered
Company

Preface and Table of Contents

Daniels tools have been utilized in military aircraft and aerospace programs for over 60 years (DMC founded in 1949). By continuously planning and adding to our product lines, we are now fulfilling the demands of other high technology fields such as telecommunications, fiber optics, lasers, and many other areas of electronic packaging.

The people behind the DMC name are pleased to present our Connector Assembly Tools and Accessories on the pages that follow. We believe the application data which accompanies each section will answer your specific questions concerning tooling; however, we encourage you to contact us by telephone or fax for the personal services of our knowledgeable staff of application experts.

CONTENTS

Important Facts About Crimping	1
Tensile Test Systems.....	2
MPT-250B (Motorized 250 lb).....	3
PT-150H (Manual 150 lb).....	4
HPT-200 (Portable, Manual 200 lb)	5
Standard Adjustable Indent Crimp Tool.....	6
M22520/1-01 (AF8).....	
Miniature Adjustable Indent Crimp Tools.....	8
M22520/2-01 (AFM8).....	8
M22520/7-01 (MH860).....	9
M22520/34-01 (39-000).....	9
Battery Powered Hydraulic Indent Crimp Tools	10
Pneumatic Indent Crimp Tools	12
Auto-Lift Pneumatic Indent Crimp Tools	14
Large Gage Pneumatic Indent Crimp Tools.....	16
M22520/23-01 (WA23).....	
Large Gage Contact Application Information	17
Technical Application Guide for Contacts and Connectors	22
Connector Illustration	22
Contact Color Code (BIN).....	22
M39029 Contact Quick Location Chart	23
MIL-STD-1760 Connector Tooling	24
Installing and Removal Tools	56
MIL-I-81969.....	
Contact Retention Test Tools	62
Contact Gages	63
Unwired Contact Removal Tools	64
M81969/30.....	
BETA Backshell Torque Tools	65
EMI/RFI Band Application System	66
MIL Spec Circular Indent Crimp Tools	69
M22520/4-01 (GS100-1).....	
M22520/31-01 (GS200-1).....	
Open Frame Crimp Tools	70
M22520/5-01 (HX4).....	
M22520/10-01 (HX3).....	

Battery Powered Hydraulic Open Frame Crimp Tools	72
Pneumatic Open Frame Tools	74
X-Die Pneumatic Tool/Bench Press Hand Tools.....	75
Electric Hydraulic Open Frame Crimp Tool	76
DMC Y-Dies For A Full Range of Capabilities	77
Typical Y-Die Configurations and Applications	
Coaxial Contact Tool Selection Guide	78
R.F. Connectors Tool Selection Guide	80
Mid-Current Range Adjustable Indent Crimp Tools	92
Circular Indent Crimp Tools	96
Special Application Indent Crimp Tools.....	98
MH835 & MH992 (Fine Tipped Indenter Tools)	98
MH800 (Ultra Precision).....	99
MH820 (Stainless Steel Indenter).....	99
SC8 & MH993 (Biased Crimp Tools).....	100
Dedicated Application Indent Crimp Tools	101
LH8 (for Burndy YHMM Series Contacts).....	
GS217 (MIL-C-22442/32-1 Clamping Ring Crimp Tool).....	
GMT Series Precision Crimp Tools.....	102
Battery Powered Hydraulic GMT Crimp Tools.....	104
DCT Series Crimp Tools	106
Hydrac 3.5 Ton Hydraulic Y-Die Crimp Tool.....	108
Hydrac 3.5 Ton Hydraulic HD36-Die Crimp Tool	109
Hydrac 5.5 Ton Hydraulic HD51-Die Crimp Tool	112
Hydrac 7 & 12 Ton Hydraulic Crimp Tool for HD002, HD485, and HD442 Dies (AS5259).....	114
Air Powered Hydraulic Pump (HPU11M).....	116
Hydrac 7 Ton Dieless Four Indent Crimper	116
Wire Harness Spoon.....	117
Cable Tie Removal Tools.....	117
Technical Application Guide for Terminals and Splices	118
Hand-Held Pneumatic Wire Stripping Tool.....	164
Swaging Tool & Tool Kit	166
Wiring System Service Kits	168
Limited Warranty.....	172

DANIELS MANUFACTURING CORP.

526 THORPE RD. • ORLANDO, FL 32824 U.S.A.

PHONE 407/855-6161 • FAX 407-855-6884

E-MAIL: DMC@DMCTOOLS.COM • WWW.DMCTOOLS.COM

CAGE CODE: 11851

FOR WARRANTY & LIMITATION OF LIABILITY INFORMATION SEE PAGE 172

NOTICE

ANY PRICES WE QUOTE VERBALLY OR ANY PRICES APPEARING IN OUR PRINTED PRICE LISTS ARE SUBJECT TO CHANGE WITHOUT PRIOR NOTICE. IF YOU NEED FIRM PRICES FOR FUTURE DELIVERIES YOU SHOULD REQUEST A WRITTEN QUOTATION FROM OUR SALES OFFICE. WE ARE NOT LIABLE FOR CONSEQUENTIAL OR SPECIAL DAMAGES OF ANY NATURE OR KIND, RESULTING FROM THE USE OF ANY OF OUR PRODUCTS.

TIME LINE FOR CRIMP TECHNOLOGY

- 1940s** All terminations were soldered (Hard-wired)
- 1953** AMP introduced Crimp Barrel Terminals
- 1957** Cannon Brothers experimented with Machined Contacts with Crimp Barrels
- 1960** Buchanan introduced the 4 Indent Crimp Tool with a Ratchet (Ref: MS3191)
- 1963** MS3191-1 was published as the first Crimp Tool Standard.
- 1965** MS3191-4 introduced by Daniels Manufacturing Corp.
- 1969** MIL-T-22520 published and dated to replace all previous specifications
- 1974** Changed to MIL-C-22520, and many Slash Sheets added
- 1996** Changed to MIL-DTL-22520
- 2010** Changed to AS22520

CRIMPING: THEN AND NOW

The first multi-pin connectors were terminated by soldering the conductor to non-removable contacts. However, high temperature applications and the need for simple and reliable field service led to the introduction of connectors with removable contacts. These were crimped onto the conductor rather than being soldered.

The first standard crimp tool developed to crimp these new contacts was introduced in the early sixties. MS3191-1, a military drawing, defined this tool and its accessories. The MS3191-1 utilized a four indent crimp pattern together with a positive stop locator which controlled the travel of the indenters (crimp depth).

The MS3191-1 design was a compromise between simplicity of operation and crimp performance since the crimp depth for any given contact was not adjustable to accommodate the differing diameters of the conductors to which it would be crimped. It was, however, suitable for the crimp connectors of that era.

An improved tool design featuring independently adjustable crimp depths was soon introduced as MS3191-4. The MS3191-4 had an internal adjustment, totally independent of the locator, which permitted the selection of seven separate crimp depths, allowing optimal crimping of conductors ranging from AWG 12 to 26 regardless of the wire barrel size of the contact.

MS3191-4 also introduced the use of the double tipped indenter to produce an eight indent crimp pattern which has consistently achieved superior tensile pull off values.

MS3191-4 introduced the concept of a turret head containing three locators which could be used without separating any of them from the basic crimp tool.

In 1969 two military specifications for crimp tools were developed to replace the existing military drawings. They were MIL-T-22520C (Navy) and MIL-T-83724 (USAF) which defined a standard size crimp tool similar to the MS3191-4, but with an expanded eight step crimp depth range. These specifications also defined a miniature crimp tool to crimp conductors as small as AWG 32.

Both documents were combined in 1971 into MIL-C-22520D. All previous military standards for crimp tools were then cancelled including the MS3191. This list includes specifications for indent crimp tools, terminal lug crimp tools, pneumatic tools, coaxial cable crimp tools and connector service kits.

MIL-DTL-22520 established a single specification which set forth performance requirements for all crimp tools to be used on military standard electrical connectors. This eliminated the waste and confusion which accompanied the overlapping applications of many different "standard" crimp tools called out by a deluge of unrelated military drawings.

THE CRIMPING CONCEPT

Crimping is a method of firmly attaching a terminal or contact end to an electrical conductor by pressure forming or reshaping a metal barrel together with the conductor. The forming of a satisfactory crimp depends on the correct combination of conductor, crimp barrel and tool.

When applied with a properly matched tool, a union is established which has both good electrical and mechanical characteristics. The tool will provide these requirements consistently and reliably with repeatability assured by quality cycle controlled tooling. There are several common configurations of crimped joint; several examples are shown below.

The electrical resistance of a properly designed and controlled crimped joint should be equal to, or less than, the resistance of an equal section of wire.

Specifications state the requirements in terms of millivolt drop at a designated current.

The mechanical strength of a crimped joint and hence its pull-out force (tensile strength), varies with the deformation applied. Therefore, by properly shaping the deformation a high pull-out force can be achieved, i.e. the crimp die of the tool determines the crimp configuration and deformation.

The dies in the tool determine the completed crimp configuration which is generally an element of contact and/or connector design. Some of the design considerations are: a) The type of contact, its size, shape, material and function, b) The type and size of wires to be accommodated, c) The type of tooling into which the configuration must be built.

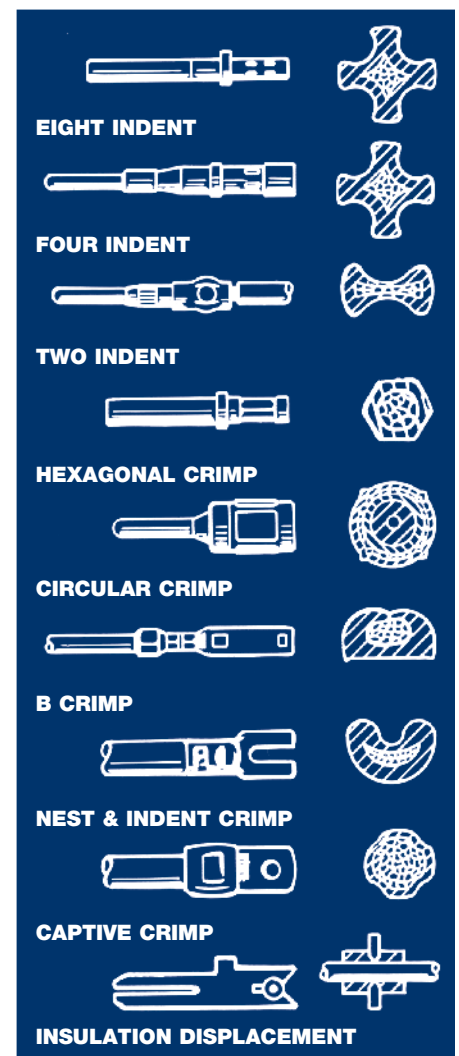

Tensile Test Systems

For Wire Terminations and Similar Applications



THE DEPENDABLE ALPHATRON™ TENSILE TEST SYSTEM

Now available from DMC is a line of Electronic Tensile Test Systems which may be used in conjunction with SPC Programs or other Quality Control disciplines in both OEM and maintenance applications. The electronic digital readout displays are a fast and reliable source of test data.

The rugged construction and the portable design of these test machines make any of them a superior choice for on-site or laboratory use in an infinite variety of applications. The operation of the equipment is simple yet versatile, and DMC will customize the gripping

jaws or other components to make test sample installation and removal an easy task.

Models are available with output display readings in Pounds, Newtons, and/or Kilograms to conform with the requirements of the user's system. Units are available for either 115 or 230 volt power input.

It's only natural that the company which supplies the best wire termination tools and equipment would add the very best Digital Tensile Testers to further meet the demand for fewer sources and improved support through a wider range of user needs.

The MPT-250B Motorized Wire Crimp Pull Tester is ideal when a constant rate of pull is desired. It tests crimp strength on terminations up to size 8 in Mil-Spec applications, and size 1/0 AWG in commercial and automotive applications.

The PT-150H Manual Wire Crimp Pull Tester is ideal for testing crimp strength up to size 10 for Mil-Spec applications, and size 4 AWG for commercial and automotive applications.

The HPT-200 hand-held pull tester blends the accuracy and rugged design of the Alphatron pull testers into a self-contained, portable, rechargeable battery powered unit. It is ideal for testing crimp strength up to size 10 AWG in Mil-Spec applications, and size 10 AWG in commercial and automotive applications.

MPT-250B-SC MOTORIZED SAFE-T-CABLE™ TESTER

The specifications for this model are the same as MPT-250B.

The MPT-250B-SC is equipped to test .020", .032" and .040" diameter Safe-T-Cable™.



**MOTORIZED PULL TESTERS
MPT-250B**



**MANUAL PULL TESTERS
PT-150H**



**HAND-HELD PORTABLE PULL TESTER
MODEL HPT-200**

GENERAL SPECIFICATIONS

	MPT-250B	PT-150H	HPT-200
Capacity	250 lbf 113 kg 1112 N	150 lbf 68.0 kg 667 N	200 lbf 90.7 kg 889 N
Accuracy	±0.5% (1/2 of 1%)	±0.5% (1/2 of 1%)	±0.5% (1/2 of 1%)
Resolution	0.1 lbf	0.1 lbf	0.1 lbf
Display Type	Digital Display w/Peak Hold Reading	Digital Display w/Peak Hold Reading	Digital Display w/Peak Hold Reading
Display	LED w/.56" high digits	LED w/.56" high digits	LED w/.56" high digits
Electrical	115 VAC, 50/60 Hz 230 VAC, 50/60 Hz	115 VAC, 50/60 Hz 230 VAC, 50/60 Hz	Int. Battery 115 VAC, 50/60 Hz Charger 230 VAC, 50/60 Hz Charger Available
Operating Temperature	50°F to 100°F (10° to 38°C)	50°F to 100°F (10° to 38°C)	50°F to 100°F (10° to 38°C)

DIMENSIONS

	MPT-250B	PT-150H	HPT-200
Height	9.5 in. (24.13 cm)	5 in. (12.7 cm)	2 in. (5.08 cm) case
Width	10 in. (25.4 cm)	8.5 in. (21.6 cm)	9.5 in. (24.13 cm) case
Depth	15 in. (38.1 cm)	16 in. (40.6 cm)	6.25 in. (15.87 cm) case
Weight	26 lbs. (11.78 kg) (less options)	15.2 lbs. (6.89 Kg) (less options)	2.5 lbs. (1.13 kg) case and hand unit

MPT-250B

Motorized Wire Crimp Pull Tester

The MPT-250B Motorized Wire Crimp Pull Tester has a range from five pounds force to two-hundred and fifty pounds (2-113 Kg, 22-1112 N).

You can expect the same precision and dependability that has established all ALPHATRON® testers as the first choice for wire harness builders and component suppliers throughout the industry. The 250 pound capacity of this tester will extend the range of testing capabilities to size 8 Mil-Spec applications*, and size 1/0 AWG in commercial and automotive applications** (Reference AS7928 and UL486 Respectively).

The portable design (25 pounds, 9.5"x10"x16") and the rugged construction (machined aluminum and steel) contribute to the versatility and reliability of the MPT-250B Pull Tester. A variety of options, including standard and custom grips for all types of wire terminations are available on this tester. The operation of the tester is simple and has automatic reset and auto-stop features incorporated into the design. The peak-hold digital display indicates the highest pull force that is measured by the accurate load cell/digital processor until the reset switch is pressed.

Consult the factory for more specific information, and application verification.
NSN: 6635-01-581-9996

SPECIFICATIONS FOR THE MPT-250B MOTORIZED WIRE CRIMP PULL TESTER

- Capacity Range 5-250 lbs. (2-113 kg, 22-1112 N)
- Pull Rate: 1 to 10"/min. Push-button Selectable in 1"/min. Increments.
- Pull Rate Accuracy
± 1/8"/min. @ 1-5"/min. Rate of Pull
± 1/4"/min. @ 6-10"/min. Rate of Pull
- Auto-Stop at Wire/Crimp Break Point
- Auto Return to Start Position
- 15 Position Slotted Lower Terminal Grip.
- Display Units in Pounds, Kilograms, or Newtons
- Lb/Kg/Newton Switching Built in

MPT-250B Options: Universal Self-Tightening Cam-Type Lower Grip • Ring Terminal Lower Grip • 7.5-30"/min. Selectable Rates of Pull in 10 2.5"/min. Increments • Adjustable Set-point for Motor Stop at Pre-Set Force.



* Size 8 MIL Spec wire pull test is typically 220 pounds force. Sample may not break at 250 pounds.

** May require special grips due to wire diameter.

Terminal & Wire Grips

Custom Grips Available.
Consult DMC for details.

SLOTTED TERMINAL GRIP (standard)

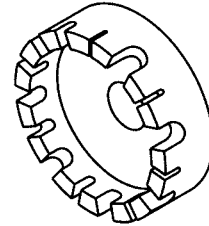

P/N 15-3087

RING TERMINAL GRIP* (optional)

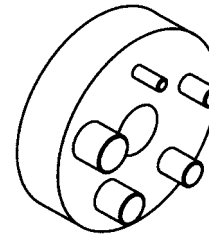

P/N 15-0066

*Some ring terminals are not suitable for this grip.

SELF TIGHTENING GRIP (optional)

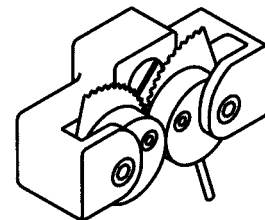

P/N 15-3202

MINIATURE TERMINAL GRIP (optional)



P/N 15-3241



PT-150H

Wire Crimp Pull Tester

The PT-150H Manual Wire Crimp Pull Tester is ideal for testing crimp strength up to size 10 for Mil-Spec applications*, and size 4 AWG for commercial and automotive applications**. The PT-150H may be used in conjunction with SPC Programs or other Quality Control disciplines in both OEM and maintenance applications. The electronic digital readout display is a fast and reliable source of test data.

The operation of the equipment is simple yet versatile, and DMC will customize the gripping jaws or other components to make test sample installation and removal an easy task.

* Size 10 MIL Spec wire pull test is typically 150 pounds force. Sample may not break at 150 pounds.

** May require special grips due to wire diameter.



STANDARD FEATURES

- Capacity: 150 lb, 667 N, 68 Kg
- Display units factory set for pounds, newtons or kilograms
- Resolution: 0.1 lb
- Accuracy: $\pm 0.5\%$ of full scale
- Digital Display with Peak Hold
- Backlit LCD Display with 0.56" High Digits
- Self-Tightening Wire Grip
- 15 Position Slotted Terminal Contact Grip
- Lever Arm Pull Mechanism

OPTIONAL ACCESSORY GRIPS

- Ring Terminal Grip (P/N 15-0066)
- Self-Tightening Grip (P/N 15-3202)
- Right Angle Terminal Grip (P/N 15-3042)

PHYSICAL

- Weight 15.2 Lbs.
(Shipping Weight 21 Lbs.)
- Stand Dimensions:
H. 5", W. 8.5", D. 16"

CALIBRATION

- New units supplied with certificate of calibration traceable to NIST
- Factory calibration available

OPTIONAL FEATURES

- 230 VAC 50/60 Hz Power (P/N 15-7004)

Terminal & Wire Grips Custom Grips Available. Consult DMC for details.

SLOTTED TERMINAL GRIP (standard)

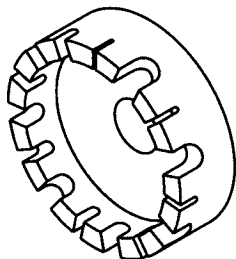

P/N 15-3087

RING TERMINAL GRIP (optional)

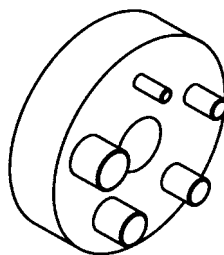

P/N 15-0066

SELF-TIGHTENING GRIP (optional)

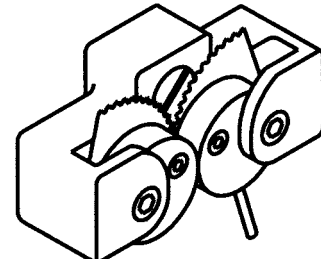

P/N 15-3202

HPT-200

Hand Held Wire Crimp Pull Tester



Daniels Manufacturing Corporation introduces a portable tensile tester capable of pull testing wire crimps up to 200 pounds (up to 10 AWG wire in most cases).

THE LAB IS NO LONGER THE LIMIT...

It is only natural that the company, which is known throughout the world for quality wire termination tools and equipment would add the very best portable tensile tester to meet your need for fewer sources and improved support through a wider range of capabilities. The HPT-200 hand held pull tester combines the accuracy and rugged design of the Alphatron pull testers into a portable battery powered unit. We follow that up with our expert factory service and calibration.

The HPT-200 portable tester is an extension of the Alphatron Wire Crimp Pull Tester line of products, which include the PT-150H and MPT-250B. These testers perform pull-force measurements on wire terminations. The rugged construction and portable design of these test machines make any of them a superior choice for on-site or laboratory use.

The lightweight Alphatron HPT-200 is a self-contained tester that extends your testing capability to the shop floor. You no longer have to wait for process samples to arrive in the QA Lab. Durable construction and a convenient carry case ensure protection. The Low Stress tensioning mechanism makes the HPT-200 versatile and easy to use. A built in NIHM battery provides up to 14 hours use on a single charge and the Power Management Circuit allows use during charging.

UPPER GRIP Standard Terminal Grip

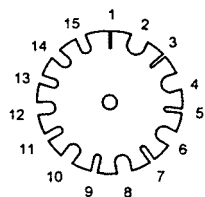

P/N 15-3035

SLOT DIMENSION

No.	Size (in.)	No.	Size (in.)
1	.031	9	.094
2	.250	10	.188
3	.047	11	.110
4	.236	12	.172
5	.063	13	.125
6	.218	14	.158
7	.080	15	.141
8	.203		



- Portable, lightweight and ergonomic design
- Built-in NIMH battery, with charger
- Up to 14 hour use on a single charge
- Low stress tensioning mechanism
- Protective carrying case
- Shoulder bag (optional)
- Built-in calibration test
- Accuracy: (0.5% of full scale)
- Resolution: (0.1 pounds)
- Display in newtons, or kilograms is available

SPECIFICATIONS:

- Capacity: 200 LBF, 90.7 kg, 889N
- Accuracy: $\pm .5\%$ of full scale
- Resolution: .1 lbf
- Display Type: Digital display w/ peak hold reading
- Display: LCD w/.56 in. high digits
- Electrical: 115 VAC 50/60 Hz or 12 VDC Int. Battery
- Operating Temperature: 50°F to 100°F (10° to 38°C)
- Height: 2 in. (5.08 cm) case
- Width: 9.5 in. (24.13 cm) case
- Depth: 6.25 in. (15.87 cm) case
- Weight: 2.5 lbs. (1.21 kg) case and hand unit

A 230 volt unit is available.
P/N HPT-200-230

Standard Adjustable Crimp Tool

UPPER RANGE CRIMP TOOL AF8 M22520/1-01

The DMC AF8, qualified to MIL-DTL-22520/1*, has virtually limitless application within the specified **wire range of 12 through 26 AWG**. Over a thousand turret heads are available to adapt the tool frame to your specific military or proprietary contact/wire combination. The 8 impression crimp, which is standard in the AF8, assures absolute maximum tensile strength with almost every closed barrel contact. Special indent configurations and gaging are available upon request.

For proper operation, the tool must be mated with one of the following optional accessories: a military standard or non-military turret head (TH-XXX Part No. Series), a military standard or non-military positioner (TP-XXX Part No. Series), or an adjustable head (Part No. UH2-5). This is done simply by orienting the head in the keyed position, and by tightening the hex socket screws provided as part of the head.

The precision ratchet controls cycling of the tool in both directions of handle movement. This assures the same accurate crimp every time. It's like having a quality control inspector at every work station.

Positive crimp depth is controlled by an 8 position selector knob conveniently located on the tool frame. The operator simply dials the desired step for the wire being used. This setting can be secured by use of a locking pin or safety wire.

The carefully engineered design achieves the absolute maximum mechanical advantage and the tool's light weight helps minimize operator fatigue.

A permanent dataplate is affixed to all turret heads and positioners. This plate lists specific contact part numbers, the corresponding position color code (for 3 position turret heads), and suggested selector depth settings for the wire size being used.

The adjustable head (P/N UH2-5) is ideally suited for lab work and prototype production applications. This head is attached in the same manner as explained above. The selected contact is inserted through the entry hole on the opposite side of the tool frame from the head. The height adjusting screw is then rotated until the contact is in the proper position for crimping. The screw can be secured with the locknut provided. Some testing will be necessary to determine the optimum selector setting for your contact/wire combination.

The AF8 is approximately 9¼" x 2½" x 1¼" and weighs 15 oz.

* Change to SAE AS22520 in process consult DMC for status.

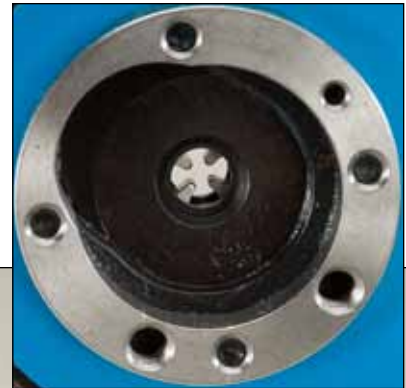

Other than keeping the unit clean and properly stored when not in service, no operator maintenance is required. DMC offers complete factory service by knowledgeable technicians within a reasonable turnaround time. Complete instructions concerning the use, care and warranty are supplied with each tool. Additional copies are available on request.

Pneumatic versions of this tool are found on page 12.

The battery powered versions of this tool are found on page 10.



MILITARY P/N	DMC P/N	DESCRIPTION	NSN
M22520/1-01	AF8	TOOL FRAME	5120-01-335-8571
M22520/1-02	TH1A	TURRET	5120-01-335-8834
M22520/1-03	TH4	TURRET	5120-01-335-8835
M22520/1-04	TH163	TURRET	5120-01-335-8836
M22520/1-05	UH2-5	ADJUSTABLE POSITIONER	5120-01-335-8583
M22520/1-06	TP45	POSITIONER	5120-01-335-8584
M22520/1-07	TP85	POSITIONER	5120-01-335-8585
M22520/1-08	TH199S	TURRET	5120-00-016-7654
M22520/1-09	TP360	POSITIONER	5120-01-335-8586
M22520/1-10	TP365	POSITIONER	5120-01-335-8587
M22520/1-11	TP465	POSITIONER	5120-01-335-8588
M22520/1-12	TH270	TURRET	5120-01-335-8838
M22520/1-13	TH285	TURRET	5120-01-036-9221
M22520/1-14	TH286	TURRET	5120-01-036-9222
M22520/1-15	TP485	POSITIONER	5120-01-335-8589
M22520/1-16	TP513	POSITIONER	5120-01-335-8590
M22520/1-17	TP651	POSITIONER	5120-01-335-8591
M22520/3-1	G125	GAGE	5220-01-016-6002
	DMC1186	M22520/1 Tool Kit	

The DMC1186 tool kit contains the AF8 tool frame, tool gage, and all mil-spec positioners and turret heads. Also included in the DMC1186 are tool instruction sheets and a tool selection chart.

Periodic gaging is recommended to insure accurate calibration. This can be done easily by setting the tool selector knob to position #4, and checking indenter closure with the M22520/3-1 "GO/NO-GO" gage (DMC part no. G125).



INSERT CONTACT



INSERT PRE-STRIPPED WIRE



CLOSE / OPEN HANDLE



REMOVE TERMINATED WIRE ASSEMBLY

Miniature Adjustable Crimp Tools

LOWER RANGE CRIMP TOOL AFM8 M22520/2-01

Qualified to MIL-DTL-22520/2*, the DMC AFM8 is designed for most of the miniature and sub-miniature connector types that are so widely used in electronic systems. The AFM8 meets the need for a miniature tool accommodating **wire sizes 20 through 32 AWG**.

The AFM8 gives a Mil-Standard 8 impression crimp, which assures maximum tensile strength. The cycle controlled precision ratchet assures consistently accurate crimps every time. The tool frame has a built-in 8 step selector knob for ease in dialing the correct crimp depth setting for the wire being used.

Positioners adapt the tool frame to a particular application. The data plate on each positioner designates which contacts the positioner accommodates for its wire size and indicates selector position. The positioner is easily removed and changed.

Periodic gaging is recommended to insure accurate calibration. This is easily accomplished with the M22520/3-1 "GO/NO-GO" gage (DMC part no. G125) on SEL setting #8. The AFM8 is 6 3/4" in length and weighs approximately 10 oz.

Other than keeping the tool clean and properly stored when not in use, no operator maintenance is required. *Pneumatic versions of this tool are found on page 12.*



The DMC274 tool kit contains the AFM8 tool frame, tool gage, and all mil-spec positioners. Also included in the DMC274 are tool instruction sheets and a tool selection chart.



MILITARY P/N	DMC P/N	DESCRIPTION	NSN
M22520/2-01	AFM8	TOOL FRAME	5120-01-335-8572
M22520/2-02	K1S	POSITIONER	5120-01-335-8592
M22520/2-03	K60S	POSITIONER	5120-01-335-8593
M22520/2-04	K151	POSITIONER	5120-01-335-8594
M22520/2-05	K3	POSITIONER	5120-01-335-8595
M22520/2-06	K41	POSITIONER	5120-01-335-8624
M22520/2-07	K40	POSITIONER	5120-01-335-8625
M22520/2-08	K13-1	POSITIONER	5120-01-335-8626
M22520/2-09	K42	POSITIONER	5120-01-335-8627
M22520/2-10	K43	POSITIONER	5120-01-335-8628
M22520/2-11	K287	POSITIONER	5120-01-335-8629
M22520/2-12	K286	POSITIONER	5120-01-335-8630
M22520/2-13	K338	POSITIONER	5120-01-335-8631
M22520/2-14	K340	POSITIONER	5120-01-335-8632
M22520/2-15	K341	POSITIONER	5120-01-335-8633
M22520/2-16	K339	POSITIONER	5120-01-335-8634
M22520/2-17	K342	POSITIONER	5120-01-335-8635
M22520/2-18	K343	POSITIONER	5120-01-335-8636
M22520/2-19	K330-2	POSITIONER	5120-01-335-8637
M22520/2-20	K331-2	POSITIONER	5120-01-335-8638
M22520/2-21	K332-2	POSITIONER	5120-01-335-8609
M22520/2-22	K212	POSITIONER	5120-01-335-8610
M22520/2-23	K267-1	POSITIONER	5120-01-335-8611
M22520/2-24	K75S-1	POSITIONER	5120-01-335-8612
M22520/2-25	K261-1	POSITIONER	5120-01-335-8613
M22520/2-26	K262-1	POSITIONER	5120-01-335-8614
M22520/2-27	K269-1	POSITIONER	5120-01-335-8615
M22520/2-28	K373-1	POSITIONER	5120-01-335-8616
M22520/2-29	K372-1	POSITIONER	5120-01-335-8617
M22520/2-30	K404	POSITIONER	5120-01-335-8618
M22520/2-31	K406	POSITIONER	5120-01-335-8619
M22520/2-32	K496	POSITIONER	5120-01-335-8620
M22520/2-33	K74S	POSITIONER	5120-01-335-8621
M22520/2-34	K323	POSITIONER	5120-01-335-8622
M22520/2-35	K532-1	POSITIONER	5120-01-335-8623
M22520/2-36	K473	POSITIONER	5120-01-335-8596
M22520/2-37	K709	POSITIONER	5120-01-361-9666
M22520/3-1	G125	GAGE	5220-01-016-6002
	SK2/2	ADJUSTABLE POSITIONER	5120-01-171-1569
	DMC274	M22520/2 TOOL KIT	5180-01-259-0512

* Change to SAE AS22520 in process consult DMC for status.



**MIDDLE RANGE
INDENT CRIMP TOOL
MH860 M22520/7-01**

Qualified to MIL-DTL-22520/7*, the DMC MH860 is a recent addition to the military specification. It was developed to meet the demonstrated need for supporting the majority of electrical systems with one versatile crimp tool frame.

The MH860 accepts the entire middle wire range of 16 through 28 AWG, with positioners which adapt it to virtually all applications consistent with others in the MIL-DTL-22520 family.

Pneumatic versions of this tool are found on page 12.



The DMC123 tool kit contains the MH860 tool frame, tool gage, and all mil-spec positioners. Also included in the DMC123 are tool instruction sheets and a tool selection chart.

* Change to SAE AS22520 in process consult DMC for status.

MIL 860 PART NUMBERS			
MILITARY P/N	DMC P/N	DESCRIPTION	NSN
M22520/7-01	MH860	TOOL FRAME	5120-01-335-8573
M22520/7-02	86-1S	POSITIONER	5120-01-335-8597
M22520/7-03	86-2	POSITIONER	5120-01-335-8598
M22520/7-04	86-3	POSITIONER	5120-01-335-8599
M22520/7-05	86-4	POSITIONER	5120-01-335-8600
M22520/7-06	86-5	POSITIONER	5120-01-335-8601
M22520/7-07	86-6	POSITIONER	5120-01-335-8602
M22520/7-08	86-7	POSITIONER	5120-01-335-8603
M22520/7-09	86-11S	POSITIONER	5120-01-335-8604
M22520/7-10	86-12S	POSITIONER	5120-01-335-8605
M22520/7-11	86-19	POSITIONER	5120-01-335-8606
M22520/7-12	86-20	POSITIONER	5120-01-335-8607
M22520/7-13	86-21	POSITIONER	5120-01-335-8608
M22520/3-3	G145	GAGE	5120-00-338-0378
	86-37	ADJUSTABLE POSITIONER	
	DMC123	M22520/7 TOOL KIT	5180-01-355-5616



MIL-DTL-28840 TOOLING PART NUMBERS			
MILITARY P/N	DMC P/N	DESCRIPTION	NSN
M22520/34-01	39-000	BASIC CRIMP TOOL	5120-01-242-3516
M22520/34-02	39-102	POSITIONER	5120-01-242-1041
M22520/35	G345	GAGE	5220-01-392-1065
M81969/33-01	DAK55-22SA	INST. TOOL (STRAIGHT)	5120-01-230-1506
M81969/33-02	DAK55-22JA	INST. TOOL (OFFSET)	5120-01-335-8666
M81969/34-01	DRK56-22A	REMOVAL TOOL	5120-01-230-1507
	DMC782	MIL-C-28840 TOOL KIT	5180-01-363-1391

**THE MIL-DTL-28840
TOOLING**

MIL-DTL-28840 connectors were developed for the Navy, for use with jacketed cable for shipboard applications. They are a high density circular connector series utilizing a high shock threaded coupling system with front release crimped contacts.

For these connectors DMC has added a new crimping tool to its range, the M22520/34-01.

Battery Powered Hydraulic Indent Crimp Tools

GET THE PORTABILITY OF A HAND TOOL WITH THE STAMINA OF A POWER TOOL!

DMC is pleased to present our battery powered hydraulic tools to crimp MIL-C-39029, MIL-C-39012, and a full range of proprietary contacts onto copper and aluminum cable **12 through 26 AWG**. These tools are comparable to DMC's AF8 (M22520/1-01) hand tool and use the same turret heads, positioners, and other accessories.

AFE8B

The AFE8B Battery Powered Hydraulic Indent Crimp Tool is a hand held, self-contained indent crimp tool. The crimp head, battery, and pump unit are contained in one ergonomic tool body and weighs about 4 pounds. It is comparable to DMC's AF8 hand tool and uses the same turret heads, positioners, and other accessories.

TOOL INCLUDES: Carrying Case, Two 18v Batteries (p/n HDE-LI-B), One Battery Charger (p/n HDE-LI-120C).



AFE8B

FEATURES

- Ergonomic design allows one-handed operation
- Indenters automatically open when crimp is complete
- Head rotates 350 degrees
- Red LED to display unit's current status

CRIMP CAPACITIES

- Max. Crimp Force: 1.5 Tons (13.3 kN)
- Avg. Crimp Time: 2 seconds
- Avg. Crimps per Charge: Approx. 150 (depending on size and type of contact wire)

AFE8B SPECIFICATIONS

- Length: 14.75" (375 mm)
- Width: 2.87" (72.9 mm)
- Depth: 4.5" (114.3 mm)
- Mass/Weight (w/ battery): 3.92lb (1.78kg)
- Sound Level: 75db (A) at 1 meter
- Vibration: <2.5m/s²
- Hydraulic Oil: Shell Tellus® T-15

AFE8B BATTERY (P/N: HDE-LI-B)

- Charging Voltage: 18 VDC
- Charging Time: 15 minutes
- 2 batteries included with each new tool
- Protective case included with each tool



AFM8, M3XX & MHXX BATTERY POWERED TOOLS

At the time this catalog was printed, DMC's Engineers were developing battery powered versions of our AFM8 (M22520/2-01), M-Series and MH-Series hand tool frames. Contact DMC, or check our Web site for the status of these tools.

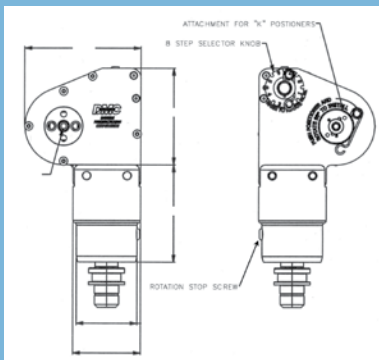

AFE8-R REMOTE HEAD BATTERY POWERED HYDRAULIC CRIMP TOOL

The AFE8-R Remote Head Battery Powered Hydraulic Indent Crimp Tool is a hand held, self-contained indent crimp tool. The crimp head is separate from the battery and pump unit by a hydraulic umbilical cable. This reduces the held weight to 2 pounds, about the same as the hand tool. The battery and pump unit can be worn on a tool belt, stored in a carrying case, or mounted to a bench

top. It is comparable to DMC's AF8 hand tool and uses the same turret heads, positioners, and other accessories.

TOOL INCLUDES: Two Batteries (p/n HD-BATTERY-R), One Battery Charger (p/n HD-110CHARGER-R), Tool Belt, AC Adapter, and Bench Mount sold separately.



AFE8-R

FEATURES

- Ergonomic design allows one-handed operation
- Indenters automatically open when crimp is complete
- Connection point for tool balancing systems

AFE8-R CRIMP CAPACITIES

- Max. Crimp Force: .75 Tons/1500lb/6.67kN
- Avg. Crimp Time: 2 seconds
- Avg. Crimps per Charge: Approx. 250

AFE8-R BATTERY (Lithium Ion)

- Charging Voltage: 10.8 VDC Lithium Ion
- Charging Time: 40 minutes



The battery and pump unit can be worn on a tool belt (p/n 2063863-1) ...



used with an AC Adapter (p/n HD-110AC)...



or mounted to a bench top (p/n BM-7).

TOOL SPECIFICATIONS

CRIMP TOOL

- Length: 11"/279mm
- Width: 2-1/2"/63.5mm
- Depth: 2-1/2"/63.5mm
- Mass/Weight: 1.82lb/.83kg
- Sound Level: 72db
- Hose Length: 4.5ft

POWER UNIT (With Battery Installed)

- Length: 9.8"/248mm
- Width: 3.1"/80mm
- Depth: 5.6"/142mm
- Weight: 4.3 lb/2.0 kg
- Sound Level: 72 dBA
- Hydraulic Oil: 1.7 oz./ 48g Shell Tellus* T15

Pneumatic Indent Crimp Tools

The DMC Power Crimp tools WA27F, WA22P and WA22 are pneumatic versions of DMC indent hand tools. They use the same turret heads or positioners, gages and other accessories. As production needs grow, all that needs to be added is the tool frame itself. The resulting power capability can in many instances compare with an automated system costing thousands of dollars more.

These pneumatic tools are widely used in both military and proprietary programs. Their popularity has come about in part because of their unequaled reputation for trouble-free, dependable service and their cost saving and adaptability.

Whether upper, middle, lower, or mid-current range, the power tools fulfill the same precise crimp requirements as

the hand models. They use the same indenter configuration, the same gaging dimensions and selector settings. No additional operator training is necessary. Accurate calibration is maintained by a unique 8 step machined steel block that holds gaging tolerances far longer than the usual adjustment screw method. This solid gaging means high output with less downtime.

The compact size and light weight of these tools allows them to be used easily as hand tools, as well as high production bench tools. The hand trigger is designed for equal ease of use by right or left handed operators. Bench mounted, the optional foot valve allows hands-free operation. The bench mount will allow the tool to be secured at virtually any angle for individual comfort, thereby minimizing operator fatigue.

UPPER RANGE WA27F (COMPARABLE TO AF8)

accommodates TH-xxx MIL-standard and commercial series turret heads or TP-xxx MIL-standard and commercial series positioners, length 10", diameter 2 3/4", weight 50 oz.

MIDDLE RANGE WA22P (COMPARABLE TO MH860)

accommodates MIL-standard and commercial 86-xxx series positioners, length 8", diameter 2 1/4", weight 32 oz.

LOWER RANGE WA22 (COMPARABLE TO AFM8)

accommodates MIL-standard and commercial Kxxx series positioners, length 8", diameter 2 1/4", weight 32 oz.



WA27-309-2C



WA27-300BT-EP



**MID-CURRENT RANGE
PNEUMATIC TOOLS**

WA27-300BT-EP is the pneumatic version of the M300BT, length 15", diameter 2 3/4", weight 119 oz.

WA27-309-2C is the pneumatic version of the M309, covering all 8 selector settings, length 12", diameter 2 3/4", weight 80 oz..

WA27-309 is the pneumatic version of the M309, covering the lower 4 selector

settings for AWG sizes 12-18, length 10", diameter 2 3/4", weight 50 oz.

WA27-309-EP is the pneumatic version of the M309, with an extra pneumatic cylinder which provides more power for crimping the upper 4 selector settings for AWG sizes 8-14, length 15", diameter 2 3/4", weight 119 oz.

Mid-Current Range Tools are featured on pages 92 to 95.



FOOT VALVE - WA10A

The foot valve, when installed in-line with an air supply, makes a portable system which is adaptable to any work bench. Air supply requirements are 80-120 PSI (5.5 to 8.0 atmospheres) clean dry air. The system uses standard air fittings readily available in most shops.



**WA22LC-X1 HAND-HELD
PNEUMATIC CRIMP TOOL**

The same basic WA22 tool that is commonly bench mounted for first end terminations is now available in a lighter, more ergonomic version for hand-held operation.



The WA22LC-X1 tool features a smaller profile and lighter weight which makes it especially useful for second end terminations on vertical and horizontal wiring form boards. Most size 20 and smaller contacts can be terminated with this tool.



BENCH MOUNT - BM-2A

The fully adjustable bench mount is compatible with most DMC power tools. The base measures 4" x 8" and can be used attached or unattached to the work surface.

Pneumatic Auto-Lift Indent Crimp Termination System



SAVE TIME AND AVOID ERRORS

DMC's standard WA-series pneumatic crimp tools are now available with an automatic actuator that eliminates the step of pressing a trigger or stepping on a foot pedal to actuate the tool.

Additionally, when the contact is loaded into the tool, the wire barrel remains in clear view. This allows the operator to see that the wire is inserted into the contact (wire barrel) correctly, with all strands inside the contact.

Once the wire is properly inserted into the contact, a little additional pressure on the wire pushes the contact into the automatic positioner. When the contact reaches the correct crimp position, the tool automatically crimps the contact on to the wire.

This line of tools available for the semi-automatic crimping of contact/wire assemblies for wire sizes 12 -32 AWG. However, Smaller wire sizes (24-32) are not very rigid and some difficulty may be experienced when pushing down on the contact/wire assembly. AP systems are not recommended for wire sizes smaller than 26 AWG.

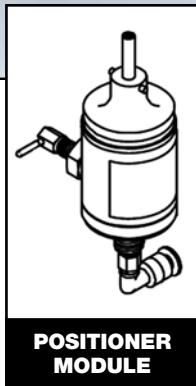

POSITIONER MODULE



STEP 1

Place an uncrimped contact with wire into the positioner insert.

When the contact is loaded into the tool, the wire barrel remains above the tool in clear view.



STEP 2

The operator can then insert the wire into the contact (wire barrel) and see that the wire is inserted correctly, with all strands inside the contact.



STEP 3

Push down lightly with the wire in one continuous motion. When the contact reaches the correct crimp position, the automatic positioner will crimp the contact to the wire.

NO foot pedal or manual activation required!



RETRO-FIT EXISTING TOOLS

If you already have one or more DMC indent crimp pneumatic tools in your shop, DMC offers a retro-fit kit (P/N - APMOD) to upgrade the standard pneumatic tools to an Auto-Lift pneumatic tool. Conversion also requires the appropriate QA series positioner modules.



COMPLETE

Remove the finished assembly and insert the next contact to be crimped.

MODULE SYSTEM

A special module is mounted to an extended bench mount and either a WA22, WA22P, WA27F or SS version pneumatic crimp tool. Separate positioner modules are attached or removed without use of tools.

Reference Military Part Number	Standard Pneumatic Tool	Tool for AP Module System
M22520/1-01	WA27F	WA27FQA
M22520/2-01	WA22	WA22QA
M22520/7-01	WA22P	WA22PQA
Other models are available - Contact DMC		

Tools ordered with a positioner module will come fully assembled and ready for your crimping need. Just plug your shop air supply into the fitting provided on the base plate module. Adjust the selector knob as specified on the dataplate of the QA module for the size wire you are crimping.

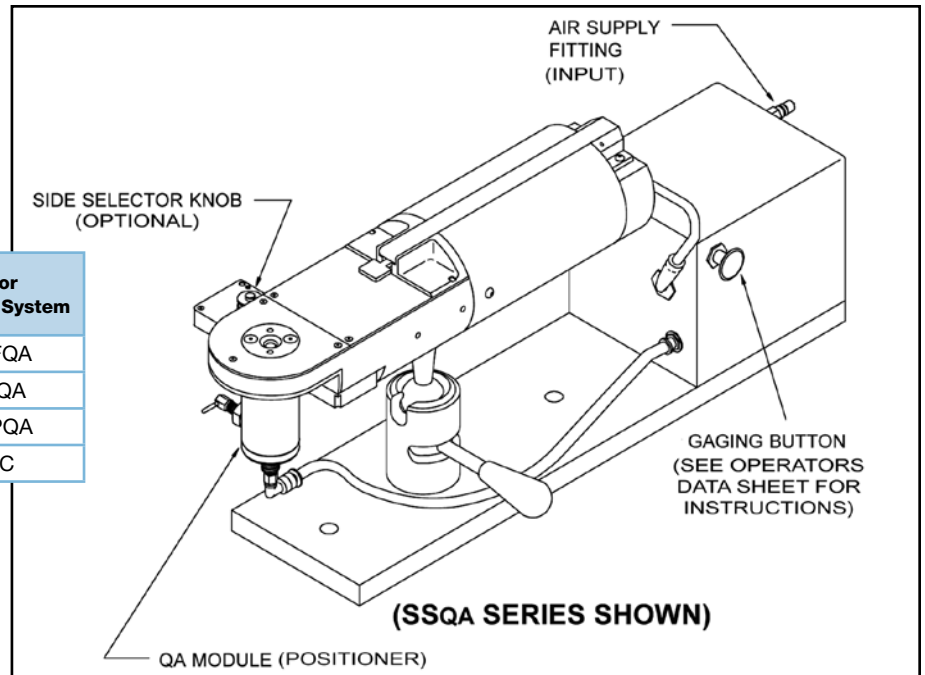

The system operates from standard shop air 80-120 psi (5.5-8.27 BAR).

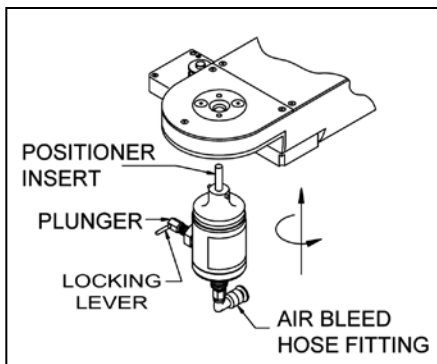

QUICK ASSEMBLY (QA) POSITIONER MODULES

These modules are constructed with bayonet type mounting protrusions enabling a quick, tool-free interchange of positioner modules for different crimping requirements. All modules are clearly marked for contact type and wire size selector setting.

Modules are available for most contacts for existing "K" and "86" Positioners and "TH" and "TP" series heads sizes 12 thru 26. These modules may be ordered separately. Modules are not available for the "Straightener" positioner series.

QA Series Positioner Module Part Number Guide

K## = KQA##

So the Quick Assembly Positioner Module version of positioner K42 is KQA42.

TH## = THQAP##-#

(The "-#" identifies the position color code with "-2" for Blue, "-4" for Red, "-5" for Yellow, and "-6" for Green.)

So the Quick Assembly Positioner Module version of turret head TH163 in the Blue position is THQAP163-2.

TP## = TPQA##

So the Quick Assembly Positioner Module version of single position head TP1032 is TPQA1032.

86-## = 86QA-##

So the Quick Assembly Positioner Module version of positioner 86-287 is 86QA-287.

Large Gage Pneumatic Indent Crimp Tools

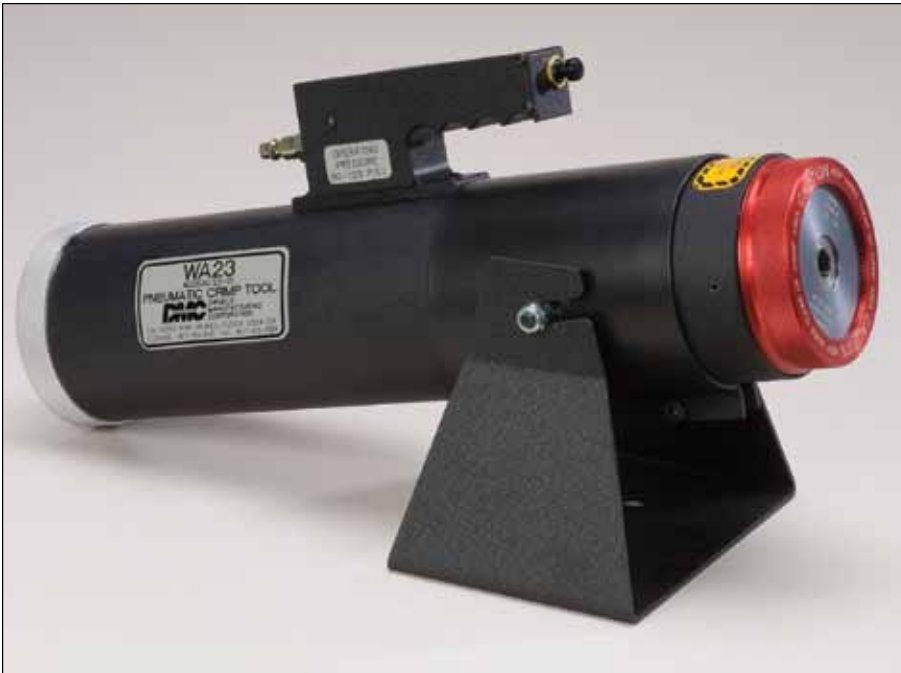

WA23 M22520/23 PNEUMATIC INDENT CRIMP TOOL

DMC's heavy pneumatic indent crimp tool functions with the push of a button for operator ease. This heavy duty crimp tool accommodates large size contacts 8 through 0000 (AWG) and operates on standard 90–125 psi (5.4–8.16 BAR) shop air sources.

It is engineered with the operator's safety in mind and features a full cycle control system. This tool is portable and needs no extra booster for large size contacts.

The standard die assembly and positioner are easily interchangeable with no special tool required. Custom dies and positioners may be designed to specific requirements. An optional foot valve is available upon request.

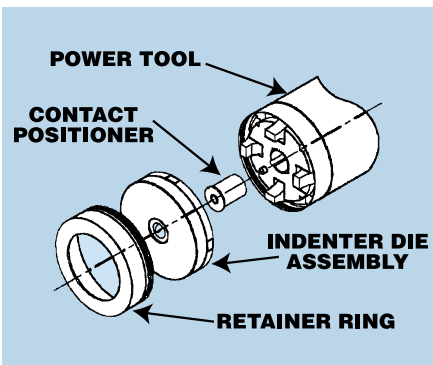

M22520/23 TOOL, DIE AND LOCATOR LIST

MIL #	DESCRIPTION	DMC #
M22520/23-01	Crimp Tool	WA23
M22520/23-02	Die Assy. 8	WA23-2
M22520/23-03	Die Assy. 6	WA23-3
M22520/23-04	Die Assy. 4	WA23-4
M22520/23-05	Die Assy. 1/0	WA23-5
M22520/23-06	Die Assy. 2/0	WA23-6
M22520/23-07	Die Assy. 4/0	WA23-7
M22520/23-09	Positioner 8	WA23-9
M22520/23-10	Positioner 6	WA23-10
M22520/23-11	Positioner 4	WA23-11
M22520/23-12	Positioner 4, 4N, 4G	WA23-12
M22520/23-13	Positioner 1/0	WA23-13
M22520/23-14	Positioner 1/0, 1/0N	WA23-14
M22520/23-15	Positioner 2/0, 2/0N	WA23-15
M22520/23-16	Positioner 4/0, 4/0N	WA23-16

WA23FP FOOT PEDAL

The WA23FP foot pedal automates the operation of the WA23 Pneumatic Crimp Tool, and allows for hands free operation. Air supply requirements are 90-120 PSI clean, dry air.

P/N	CONTACT SIZE	"GO"	"NO-GO"	GAGE P/N
M22520/23-02	8	.130	.136	G693
M22520/23-03	6	.171	.178	G694
M22520/23-04	4	.195	.202	G695
M22520/23-05	0	.325	.332	G696
M22520/23-06	00	.351	.358	G697
M22520/23-07	0000	.425	.432	G698

Non-MIL Dies and Positioners Are Also Available

Large Gage Contact Application Guide

CONTACT APPLICATION CROSS REFERENCE

CONTACT PART #	BIN CODE	TYPE P/S	SIZE	DIE ASSEMBLY	LOCATOR
MIL-C-5015 Front Release (3400 Series)					
M39029/44	291	P	8	WA23-2	WA23-9
M39029/45	298	S	8	WA23-2	WA23-9
M39029/44	292	P	4	WA23-4	WA23-11
M39029/45	299	S	4	WA23-4	WA23-11
M39029/44	293	P	0	WA23-5	WA23-13
M39029/45	300	S	0	WA23-5	WA23-13
MIL-C-5015 Rear Release (3450 Series)					
M39029/29	214	P	8	WA23-2	WA23-9
M39029/30	220	S	8	WA23-2	WA23-9
M39029/29	215	P	4	WA23-4	WA23-11
M39029/30	221	S	4	WA23-4	WA23-11
M39029/29	216	P	0	WA23-5	WA23-13
M39029/30	222	S	0	WA23-5	WA23-13
MIL-C-22992 Class L Heavy Duty Cylindrical Connector					
M39029/48	317	P	6	WA23-3	WA23-10
M39029/48	318	P	6N	WA23-3	WA23-10
M39029/48	319	P	6G	WA23-3	WA23-10
M39029/49	329	S	6	WA23-3	WA23-10
M39029/49	330	S	6G	WA23-3	WA23-10
M39029/48	320	P	4	WA23-4	WA23-12
M39029/48	321	P	4N	WA23-4	WA23-12
M39029/48	322	P	4G	WA23-4	WA23-12
M39029/49	331	S	4	WA23-4	WA23-12
M39029/49	332	S	4G	WA23-4	WA23-12
M39029/48	323	P	1/0	WA23-5	WA23-14
M39029/48	324	P	1/0N	WA23-5	WA23-14
M39029/49	333	S	1/0	WA23-5	WA23-14
M39029/48	325	P	2/0	WA23-6	WA23-15
M39029/48	326	P	2/0N	WA23-6	WA23-15
M39029/49	334	S	2/0	WA23-6	WA23-15
M39029/48	327	P	4/0	WA23-7	WA23-16
M39029/48	328	P	4/0N	WA23-7	WA23-16
M39029/49	335	S	4/0	WA23-7	WA23-16
J-Tech					
541-220-0808	214	P	8	WA23-2	WA23-9
541-220-0404	215	P	4	WA23-4	WA23-11
542-220-0808	220	S	8	WA23-2	WA23-9
542-220-0404	221	S	4	WA23-4	WA23-11
Amphenol/Bendix					
10-497100-6	317	P	6	WA23-3	WA23-10
10-497102-6	318	P	6N	WA23-3	WA23-10
10-497222-6	319	P	6	WA23-3	WA23-10
10-497100-4	320	P	4	WA23-4	WA23-12
10-497102-4	321	P	4N	WA23-4	WA23-12
10-497222-4	322	P	4G	WA23-4	WA23-12
10-497100-3	323	P	1/0	WA23-5	WA23-14
10-497102-3	324	P	1/0N	WA23-5	WA23-14
10-497100-43	327	P	4/0	WA23-7	WA23-16
10-497102-43	328	P	4/0N	WA23-7	WA23-16
10-497101-6	329	S	6	WA23-3	WA23-10
10-497223-6	330	S	6G	WA23-3	WA23-10
10-497101-4	331	S	4	WA23-4	WA23-12
10-497223-4	332	S	4G	WA23-4	WA23-12
10-497101-3	333	S	1/0	WA23-5	WA23-14

CONTACT PART #	BIN CODE	TYPE P/S	SIZE	DIE ASSEMBLY	LOCATOR
Burndy Corporation (FCI)					
10-497101-43	335	S	4/0	WA23-7	WA23-16
B559-01-3	318	P	6N	WA23-3	WA23-10
B559-01-6	319	P	6	WA23-3	WA23-10
B559-01-1	320	P	4	WA23-4	WA23-12
B559-01-2	321	P	4N	WA23-4	WA23-12
B559-01-10	322	P	4G	WA23-4	WA23-12
B559-01-4	323	P	1/0	WA23-5	WA23-14
B559-01-5	324	P	1/0N	WA23-5	WA23-14
B559-01-8	327	P	4/0	WA23-7	WA23-16
B559-01-9	328	P	4/0N	WA23-7	WA23-16
B560-01-2	329	S	6	WA23-3	WA23-10
B560-01-4	330	S	6G	WA23-3	WA23-10
B560-01-1	331	S	4	WA23-4	WA23-12
B560-01-6	322	S	4G	WA23-4	WA23-12
B560-01-3	333	S	1/0	WA23-5	WA23-14
B560-01-5	335	S	4/0	WA23-7	WA23-16
ITT Cannon					
030-3198-003	214	P	8	WA23-2	WA23-9
030-3199-004	215	P	4	WA23-4	WA23-11
030-3200-003	216	P	0	WA23-5	WA23-13
031-3116-003	220	S	8	WA23-2	WA23-9
031-3117-003	221	S	4	WA23-4	WA23-11
031-3118-003	222	S	0	WA23-5	WA23-13
Matrix Science/Amphenol					
5000-029-0008	214	P	8	WA23-2	WA23-9
5000-029-0004	215	P	4	WA23-4	WA23-11
5000-029-0000	216	P	0	WA23-5	WA23-13
5100-033-0008	220	S	8	WA23-2	WA23-9
5100-033-0004	221	S	4	WA23-4	WA23-11
5100-033-0000	222	S	0	WA23-5	WA23-13
Tri-Star					
916-0808-093	214	P	8	WA23-2	WA23-9
916-0404-094	215	P	4	WA23-4	WA23-11
916-0000-095	216	P	0	WA23-5	WA23-13
915-0808-093	220	S	8	WA23-2	WA23-9
915-0404-094	221	S	4	WA23-4	WA23-11
915-0000-095	222	S	0	WA23-5	WA23-13
915-0606-595	317	P	6	WA23-3	WA23-10
915-0606-596	318	P	6N	WA23-3	WA23-10
915-0606-597	319	P	6G	WA23-3	WA23-10
915-0404-576	320	P	4	WA23-4	WA23-12
915-0404-577	321	P	4N	WA23-4	WA23-12
915-0404-578	322	P	4G	WA23-4	WA23-12
915-1001-498	323	P	1/0	WA23-5	WA23-14
915-1001-499	324	P	1/0N	WA23-5	WA23-14
915-2020-579	325	P	2/0	WA23-6	WA23-15
915-2020-580	326	P	2/0N	WA23-6	WA23-15
915-4040-598	327	P	4/0	WA23-7	WA23-16
915-4040-599	328	P	4/0N	WA23-7	WA23-16
916-0606-595	329	S	6	WA23-3	WA23-10
916-0606-597	330	S	6G	WA23-3	WA23-10
916-0404-576	331	S	4	WA23-4	WA23-12
916-0404-578	332	S	4G	WA23-4	WA23-12
916-1001-498	333	S	1/0	WA23-5	WA23-14
916-2020-579	334	S	2/0	WA23-6	WA23-15
916-4040-598	335	S	4/0	WA23-7	WA23-16

Pico* to DMC Part Number Guide

PICO* LOCATOR	PICO DIE ASSEMBLY	DMC LOCATOR	DMC DIE ASSEMBLY	CONTACTS	AWG
4046A	414DA-8N	WA23-9 M22520/23-09	WA23-2 M22520/23-02	M39029/29-214 M39029/30-220 M39029/44-291 M39029/45-298	8
4297-6	414DA-6N	WA23-10 M22520/23-10	WA23-3 M22520/23-03	M39029/48-317 M39029/48-318 M39029/48-319 M39029/49-329 M39029/49-330	6
4112	414DA-4N	WA23-11 M22520/23-11	WA23-4 M22520/23-04	M39029/29-215 M39029/30-221 M39029/44-292 M39029/45-299	4
4297-5	414DA-4N	WA23-12 M22520/23-12	WA23-4 M22520/23-04	M39029/48-320 M39029/48-321 M39029/48-322 M39029/49-331 M39029/49-332	4
4066	414DA-1/0N 414DA-0N	WA23-13 M22520/23-13	WA23-5 M22520/23-05	M39029/29-216 M39029/30-222 M39029/44-293 M39029/45-300	1/0
4297-3	414DA-1/0N 414DA-0N	WA23-14 M22520/23-14	WA23-5 M22520/23-05	M39029/48-323 M39029/48-324 M39029/49-333	1/0
4297-2	414DA-2/0N	WA23-15 M22520/23-15	WA23-6 M22520/23-06	M39029/48-325 M39029/48-326 M39029/49-334	2/0
4297-1	414DA-4/0N-7	WA23-16 M22520/23-16	WA23-7 M22520/23-07	M39029/48-327 M39029/48-328 M39029/49-335	4/0
4536	414DA-10N	WA23-102L	WA23-101DA	EUROPEAN NORM # EN3155003 F 1010 EN3155008 F 1010	10
N/A	414DA-4N	WA23-111L	WA23-4 M22520/23-04	BENDIX - AMPHENOL # 10-113474-4P 10-113474-4S 10-229193-4S 10-229192-4P	4
N/A	414DA-1/0N 414DA-0N	WA23-113L	WA23-5 M22520/23-05	BENDIX - AMPHENOL # 10-113474-1P 10-113474-1S	1/0
N/A	414DA-12N	WA23-114L	WA23-168DA	M39029/56-353 M39029/58-365	12
N/A	414DA-12N N/A	WA23-115L	WA23-168DA WA23-169DA	M39029/11-147 M39029/12-151	12 14
4117	414DA-12N N/A 414DA-16N	WA23-116L	WA23-168DA WA23-169DA WA23-170DA	M39029/4-113 M39029/5-118 M39029/29-213 M39029/30-219 M39029/44-289 M39029/44-290 M39029/45-297	12 14 16
4001	414DA-8N	WA23-117L	WA23-2 M22520/23-02	CANNON # 031-0560-081 330-0351-008	8
4060 Cannon CCHP8-7	414DA-8N	WA23-119L	WA23-2 M22520/23-02	CANNON # 031-0733-000	8
N/A	414DA-8N	WA23-121L	WA23-2 M22520/23-02	FRANKLIN ELECTRIC # 151378-101 151378-102 151378-103	8
4234	414DA-4N	WA23-122L	WA23-4 M22520/23-04	CANNON # 030-8613-000 031-8520-000 330-0351-004 330-0351-041 (METRIC) 031-8591-000 031-8560-000	4
4233	414DA-1/0N 414DA-0N	WA23-123L	WA23-5 M22520/23-05	CANNON # 030-8614-000 031-8521-000 330-0351-000 330-0351-001 (METRIC) 031-8561-000 030-8592-000	1/0

* Pico is registered tradename for the The Pico Corporation.

PICO* LOCATOR	PICO DIE ASSEMBLY	DMC LOCATOR	DMC DIE ASSEMBLY	CONTACTS	AWG
N/A	414DA-8N	WA23-145L	WA23-2 M22520/23-02	CANNON # 030-8590-000 030-8612-000 031-8519-000 031-8559-000	8
N/A	414DA-1/0N 414DA-0N	WA23-146L	WA23-5 M22520/23 -05	HAKO MINUTEMAN # 4 LUGS	4
4329	414DA-8N	WA23-147L	WA23-2 M22520/23-02	LITTON-VEAM # 27935-T9 27915-T9	8
4042	414DA-1/0N 414DA-0N	WA23-148L	WA23-5 M22520/23-05	LITTON-VEAM # 27937-VT9 27917-VT9	1/0
N/A	414DA-8N 414DA-6N 414DA-4N	WA23-149L	WA23-2 M22520/23-02 WA23-3 M22520/23-03 WA23-4 M22520/23-04	AMP-TYCO # 213179-1 (8Ga.) 213178-1 (6Ga.) 213177-1 (4Ga.)	8 6 4
N/A	414DA-8N 414DA-6N 414DA-4N	WA23-150L	WA23-2 M22520/23-02 WA23-3 M22520/23-03 WA23-4 M22520/23-04	AMP-TYCO # 213183-1 (8Ga.) 213182-1 (6Ga.) 213181-1 (4Ga.)	8 6 4
4025 4026	414DA-8N	WA23-161L	WA23-2 M22520/23-02	BENDIX - AMPHENOL # 10-40792 P 10-40793 S 10-113239-8S 10-113239-8P 10-113474-8P 10-113474-8S	8
4231	N/A	WA23-162L	WA23-112DA	BENDIX - AMPHENOL # 10-40561	12
4043	414DA-4N	WA23-163L	WA23-4 M22520/23-04	BENDIX - AMPHENOL # 10-40564 10-40565	4
N/A	414DA-6N 414DA-4N	WA23-164L	WA23-3 M22520/23-03 WA23-4 M22520/23-04	AMP-TYCO # 92-0940-11-3 (4 Ga.) 92-0940-11-6 (6 Ga.)	6 4
N/A	414DA-6N 414DA-4N	WA13-166L	WA23-3 M22520/23-03 WA23-4 M22520/23-04	AMP-TYCO # 92-0940-9-2 (4 Ga.) 92-0940-9-9 (6 Ga.)	6 4
4116	414DA-16N	WA23-171L	WA23-170DA	M39029/4-111 M39029/5-116 M39029/29-212 M39029/30-218 M39029/44-288 M39029/45-295	16
N/A	414DA-4N	WA23-176L	WA23-4 M22520/23-04	AMP-TYCO # 93-1813-36-3 93-1813-36-6 93-1813-36-9	4
N/A	414DA-4N	WA23-177L	WA23-4 M22520/23-04	AMP-TYCO # 93-1813-37-3	4
N/A	414DA-8N 414DA-10N 414DA-12N	WA23-178L	WA23-2 M22520/23-02 WA23-101DA WA23-168DA	AMP-TYCO # 93-1813-49-9 93-1813-50-9 93-1813-52-9	8 10 12
N/A	414DA-8N 414DA-10N 414DA-12N	WA23-179L	WA23-2 M22520/23-02 WA23-101DA WA23-168DA	TYCO 93-1813-49-6 93-1813-50-6 93-1813-52-6	8 10 12
N/A	414DA-8N 414DA-10N 414DA-12N	WA23-180L	WA23-2 M22520/23-02 WA23-101DA WA23-168DA	TYCO 93-1813-49-3 93-1813-50-3 93-1813-52-3	8 10 12

* Pico is registered tradename for the The Pico Corporation.

Pico* to DMC Part Number Guide

PICO* LOCATOR	PICO DIE ASSEMBLY	DMC LOCATOR	DMC DIE ASSEMBLY	CONTACTS	AWG
N/A	414DA-4N	WA23-182L	WA23-4 M22520/23-04	ANDERSON POWER # 1319G4 (4 AWG) 1319 (2 AWG)	4 2
N/A	414DA-8N	WA23-186L	WA23-2 M22520/23-02	AMP-Tyco # 213552-2 (P)	8
4150	414DA-12N	WA23-187L	WA23-168DA	PYLE NATIONAL # ZMZ-40 12-36 ZMZ-4112-36 ZMZ-40 12-50 ZMZ-4112-50	12
N/A	414DA-16N	WA23-188L	WA23-170DA	PYLE NATIONAL # ZMZ-4016-36 ZMZ-4116-36 ZMZ-4016-50 ZMZ-4116-50	16
N/A	414DA-8N	WA23-189L	WA23-2 M22520/23-02	CANNON # 030-0560-081	8
4070	414DA-4N	WA23-190L	WA23-4 M22520/23-04	CANNON # 031-0560-041	4
N/A	414DA-8N	WA23-195L	WA23-2 M22520/23-02	BENDIX - Amphenol # 10-497086-085	12 (x 2) 8
N/A	414DA-6 IT	WA23-196L	WA23-130DA RADIAL CRIMP	AMP-TYCO # 52264-1 HOLLINGSWORTH # R4004BF WILCOX ELECT 025997-0003	6
N/A	414DA-6 NIT	WA23-201L	WA23-197DA RADIAL CRIMP	TYCO # 33465	6
N/A	414DA-4 NIT	WA23-202L	WA23-157DA RADIAL CRIMP	TYCO # 33469	4
N/A	414DA-2 NIT	WA23-203L	WA23-198DA RADIAL CRIMP	TYCO # 320383	2
N/A	414DA-1/0 NIT	WA23-204L	WA23-199DA RADIAL CRIMP	TYCO # 36917	1/0
N/A	414DA-8N	WA23-205L	WA23-2 M22520/23-02	HONEYWELL DRAWING # 414-0508 (S) 414-0509 (P)	8
N/A	414DA-4N	WA23-208L	WA23-4 M22520/23-04	M39029/45-299 M39029/44-292	4
N/A	414DA-6N	WA23-209L	WA23-3 M22520/23-02	TYCO # 322006 THOMAS & BETTS # 54136	6
N/A	414DA-6N	WA23-210L	WA23-3 M22520/23-02	THOMAS & BETTS # 54205	6
N/A	414DA-2 NIT	WA23-211L	WA23-198DA RADIAL CRIMP	THOMAS & BETTS # 54148,54208	2

* Pico is registered trademark for the The Pico Corporation.

PICO* LOCATOR	PICO DIE ASSEMBLY	DMC LOCATOR	DMC DIE ASSEMBLY	CONTACTS	AWG
N/A	414DA 10N	WA23-215L	WA23-101DA	HARTING: 0932 000 6107 0932 000 6108 0932 000 6207 0932 000 6208	10
N/A	414DA-8N 414DA-6N	WA23-217L	WA23-2 M22520/23-02 (12,10,8) WA23-3 M22520/23-03 (6)	ANDERSON POWER # 5915 (10-12 AWG) 1307 (6-8 AWG)	6 8 10 12
4046A	N/A	WA23-223L-BX	WA23-218DA	AMPHENOL # NZGC-C-8PB NZGC-C-8SB	8
4112	N/A	WA23-224L-BX	WA23-219DA	AMPHENOL # NZGC-C-4PB NZGC-C-4SB	4
4301-16S	414DA-16N-048	WA23-225L	WA23-226DA	DEUTSCH # 0460-202-16141 0462-201-16141	16
N/A	414DA-12N	WA23-227L	WA23-168DA	ANDERSON POWER # 1331	14 SOLID
N/A	414DA-8N	WA23-231L	WA23-2 M22520/23-02	CENTERLIFT PUMPS # 36697	8
N/A	414DA-6N	WA23-232L	WA23-3 M22520/23-03	CENTERLIFT PUMPS # 36698	6
N/A	414DA-4N	WA23-233L	WA23-4 M22520/23-04	CENTERLIFT PUMPS # 51200	4
N/A	414DA-8N	WA23-234L	WA23-2 M22520/23-02	COOPER CROUSE-HINDS # 3326376-1	8
N/A	414DA-8N	WA23-236L	WA23-2 M22520/23-02	COOPER CROUSE-HINDS # 132-6371-1	8
N/A	414DA-12N	WA23-237L	WA23-168DA	AMP-TYCO # 212008-1	12 WIRE BARREL
N/A	414DA-8N	WA23-237L	WA23-168DA M22520/23-02	AMP-TYCO # 211161-1	8
N/A	414DA-8 IT	WA23-256L	WA23-140DA	AMP-TYCO # UN-INSUL LUG 33463	8

NOTICE: DMC's extensive experience in the wire termination industry has provided a database of comparable tooling to other tool suppliers. DMC does not take responsibility for changes or modifications made by other suppliers or users. We do, however, make every effort to confirm the cross-reference information in our database. We encourage you to report any discrepancy you may find and we invite you to send contacts/wire to DMC prior to placing your tooling order so our technical staff can verify your application.

* Pico is registered tradename for the The Pico Corporation.

TYPICAL COMPLEX CABLE CONNECTOR

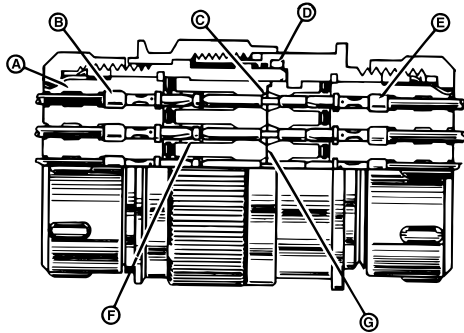

- A. Wire Seal
- B. Socket Contact
- C. Chamfered Socket Lead-In
- D. Peripheral O-Ring Seal
- E. Pin Contact
- F. Contact Retention Clip
- G. Interfacial Seal

CONTACT COLOR CODE AND BIN*

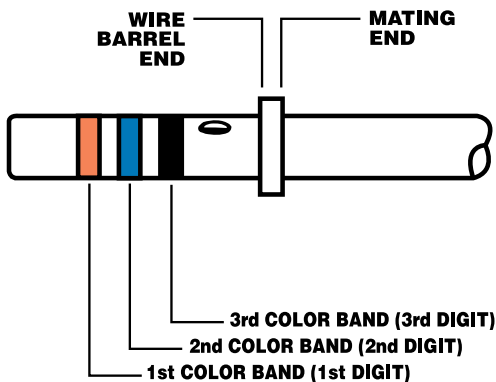

0 - Black	5 - Green
1 - Brown	6 - Blue
2 - Red	7 - Violet
3 - Orange	8 - Gray
4 - Yellow	9 - White

*BASIC IDENTIFICATION NUMBER

- Example shown: 360
(Orange, Blue, Black)
- Manufacturers have the option of identifying contacts by stamping the bin code on the shoulder or the wire barrel (size 16 and larger).

WIRE STRIPPING TECHNIQUE

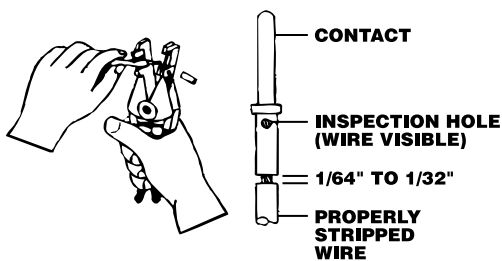

1. Determine the proper length of insulation to be removed. Wire must be visible in inspection hole. Insulation must be 1/64" – 1/32" from end of contact or inside of insulation cup.
2. Insert wire into exact center of correct slot for wire size to be stripped. Each slot is marked with wire size.
3. Close handles together as close as possible.
4. To prevent birdcaging the wire, partially open handles to allow grips to open, then remove wire before allowing handles to fully open.
5. Release handles, allowing wire holder to return to open position.
6. Remove stripped wire.
7. After stripping, strands of wire should be twisted firmly together in the same direction as the normal lay of the wire.
8. Stripped wire with nicked or cut strands is not acceptable.

IMPORTANT NOTICE – The tooling listed in the technical application guides of this catalog and other DMC publications represents data which has been compiled over many years of product use and application. Some tooling suggested herein may or may not cover a user's specific contract or manufacturing requirements. It is the user's responsibility to carry out sufficient testing to verify suitability of the specific DMC product selected for the specific requirements of each particular application.

M39029 CONTACT QUICK LOCATION CHART

CONTACT PART NUMBER	PAGE NUMBER
M39029/1	54
M39029/2	45
M39029/3	45
M39029/4	27, 48, 51, 52
M39029/5	27, 48, 51, 52
M39029/6 ¹	41, 42, 78
M39029/7 ¹	27, 41, 78
M39029/8	27, 78
M39029/9	31
M39029/10	31
M39029/11	46
M39029/12	46
M39029/13 ¹	41, 78
M39029/14 ¹	41, 78
M39029/15	Unpublished
M39029/16	44
M39029/17	43
M39029/18	43, 44
M39029/19 ¹	43, 78
M39029/20 ¹	43, 78
M39029/21 ¹	44, 78
M39029/22	43, 44, 55
M39029/23 ¹	26
M39029/24 ¹	26
M39029/25 ¹	26, 79
M39029/26 ¹	26, 79

CONTACT PART NUMBER	PAGE NUMBER
M39029/27 ¹	35, 51, 79
M39029/28 ¹	35, 37, 51, 79
M39029/29	40, 50
M39029/30	40, 50
M39029/31	26, 28, 29, 33, 47
M39029/32	26, 28, 29, 33, 47
M39029/33	41
M39029/34	30
M39029/35	30
M39029/36	30
M39029/37	30
M39029/38	Unpublished
M39029/40	Unpublished
M39029/41	Unpublished
M39029/42	Unpublished
M39029/43	Unpublished
M39029/44	39
M39029/45	39
M39029/46	42
M39029/47	41, 42
M39029/48	24
M39029/49	24
M39029/50 ¹	52
M39029/51 ¹	52
M39029/54 ¹	28, 79
M39029/55 ¹	28, 79

CONTACT PART NUMBER	PAGE NUMBER
M39029/56	34, 36, 37, 38
M39029/57	25, 35, 52
M39029/58	25, 34-38, 52
M39029/59 ¹	25, 79
M39029/60 ¹	25, 79
M39029/63	25
M39029/64	25
M39029/65	Inactive
M39029/66	Inactive
M39029/68	Inactive
M39029/69	53
M39029/70	53
M39029/71 ²	Wirewrap
M39029/72 ²	Wirewrap
M39029/73 ¹	51
M39029/74 ¹	34, 51
M39029/75 ¹	37, 34, 79
M39029/76 ¹	34, 79
M39029/77 ¹	34, 79
M39029/78 ¹	34, 79
M39029/79 ¹	Inactive
M39029/80 ¹	Inactive
M39029/83	32
M39029/84	32
M39029/85	Call DMC
M39029/86	40, 50

CONTACT PART NUMBER	PAGE NUMBER
M39029/87 ³	25, 34, 36, 38, 52
M39029/88 ³	34, 36, 38
M39029/89 ³	25, 35, 52
M39029/90 ¹	37
M39029/91 ¹	37
M39029/92	Call DMC
M39029/93	49
M39029/94	49
M39029/95	49, 79
M39029/96 ¹	49, 79
M39029/97 ¹	49, 79
M39029/98 ¹	49, 79
M39029/99 ¹	49, 79
M39029/100 ¹	49, 79
M39029/101 ⁴	Call DMC
M39029/102 ¹	34, 35, 36, 38
M39029/103 ¹	34, 36, 38
M39029/104 ¹	32
M39029/105 ¹	32
M39029/106	Call DMC
M39029/107	Call DMC
M39029/108	Unassigned
M39029/109	Unassigned
M39029/113	37
M39029/114	37

¹ shielded or coax/twinax
² not crimp barrel contacts

³ thermocouple contacts
⁴ contacts for relay socket — not a connector

QPL (Qualified Product List) sources listed in the following charts may change. Verify source QPL status at the following website: <http://www.dscc.dla.mil/programs/MilSpec/>

MIL-DTL-22992 CLASS L

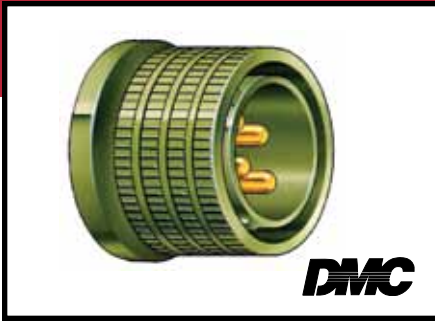

CIRCULAR HEAVY DUTY FRONT RELEASE CONTACTS

For Backshell Torquing Tools, see page 65.

CONNECTOR P/N	DESCRIPTION	QPL SOURCES
MS90555	WALL MOUNT RECEPTACLE	AMPHENOL ITT CANNON
MS90556	STRAIGHT PLUG	
MS90557	IN-LINE RECEPTACLE	
MS90558	WALL MOUNT PLUG	

CONTACTS	SIZE (AWG)		PIN/SOC.	PART NUMBER (CURRENT)	PART NUMBER (SUPERSEDED)	WIRE RANGE
	MATING END	WIRE BARREL				
	6	6	P	M39029/48-317	MS90559-11	6
	6N	6	P	M39029/48-318	MS90559-12	6
	6G	6	P	M39029/48-319	MS90559-14	6
	6	6	S	M39029/49-329	MS90560-7	6
	6G	6	S	M39029/49-330	MS90560-8	6
	4	4	P	M39029/48-320	MS90559-8	4
	4N	4	P	M39029/48-321	MS90559-9	4
	4G	4	P	M39029/48-322	MS90559-13	4
	4	4	S	M39029/49-331	MS90560-5	4
	4G	4	S	M39029/49-332	MS90560-9	4
	0	0	P	M39029/48-323	MS90559-5	0
	0N	0	P	M39029/48-324	MS90559-6	0
	0	0	S	M39029/49-333	MS90560-3	0
	2/0	2/0	P	M39029/48-325	MS90559-3	2/0
	2/0N	2/0	P	M39029/48-326	MS90559-3	2/0
	2/0	2/0	S	M39029/49-334	MS90560-2	2/0
	4/0	4/0	P	M39029/48-327	MS90559-1	4/0
4/0N	4/0	P	M39029/48-328	MS90559-2	4/0	
TYPICAL CONTACT CONFIGURATION	4/0	4/0	S	M39029/49-335	MS90560-1	4/0

TOOL SELECTION		CRIMP TOOL AND ACCESSORY					ASSEMBLY TOOLS	
BIN*	COLOR	AF8	AFM8	MH860	WA23 (POS)	WA23 (DIE)	INSTALLING	REMOVAL
317	Orange-Brown-Violet				WA23-10	WA23-3	NONE REQ.	DRK178-6A
318	Orange-Brown-Gray				WA23-10	WA23-3	NONE REQ.	DRK178-6A
319	Orange-Brown-White				WA23-10	WA23-3	NONE REQ.	DRK178-6A
329	Orange-Red-White				WA23-10	WA23-3	NONE REQ.	DRK178-6A
330	Orange-Orange-Black				WA23-10	WA23-3	NONE REQ.	DRK178-6A
320	Orange-Red-Black				WA23-12	WA23-4	NONE REQ.	DRK178-5A
321	Orange-Red-Brown				WA23-12	WA23-4	NONE REQ.	DRK178-5A
322	Orange-Red-Red				WA23-12	WA23-4	NONE REQ.	DRK178-5A
331	Orange-Orange-Brown				WA23-12	WA23-4	NONE REQ.	DRK178-5A
332	Orange-Orange-Red				WA23-12	WA23-4	NONE REQ.	DRK178-5A
323	Orange-Red-Orange				WA23-14	WA23-5	NONE REQ.	DRK178-3A
324	Orange-Red-Yellow				WA23-14	WA23-5	NONE REQ.	DRK178-3A
333	Orange-Orange-Orange				WA23-15	WA23-5	NONE REQ.	DRK178-3A
325	Orange-Red-Green				WA23-15	WA23-6	NONE REQ.	DRK178-2A
326	Orange-Red-Blue				WA23-15	WA23-6	NONE REQ.	DRK178-2A
334	Orange-Orange-Yellow				WA23-15	WA23-6	NONE REQ.	DRK178-2A
327	Orange-Red-Violet				WA23-16	WA23-7	NONE REQ.	DRK178-1A
328	Orange-Red-Gray				WA23-16	WA23-7	NONE REQ.	DRK178-1A
335	Orange-Orange-Green				WA23-16	WA23-7	NONE REQ.	DRK178-1A

DMC does NOT provide connectors, contacts, or wiring components. Parts are shown here for reference only.

MIL-DTL-24308

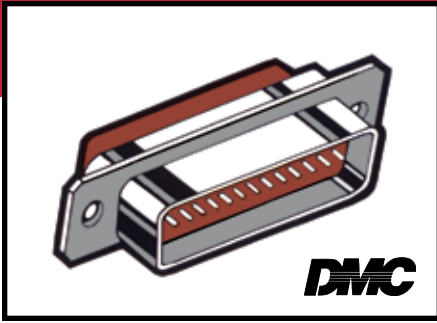

MINIATURE RECTANGULAR RACK AND PANEL REAR RELEASE CONTACTS

CONNECTOR P/N	DESCRIPTION	QPL SOURCES
M24308/2	POLARIZED SHELL SOCKET CONTACTS	ADI ELECTRONICS, AMPHENOL CORP. CW INDUSTRIES, CINCH CONNECTOR CRISTEK INTERCONNECTS, BURNDY GENERAL CONNECTOR, GLASSEAL PRODUCTS, ITT CANNON, POSITRONIC INDUSTRIES, TYCO ELECTRONICS
M24308/4	POLARIZED SHELL PIN CONTACTS	
M24308/6	POLARIZED SHELL SOCKET CONTACTS NON-MAGNETIC	
M24308/8	POLARIZED SHELL PIN CONTACTS NON-MAGNETIC	

CONTACTS	SIZE (AWG)		PIN/SOC.	PART NUMBER* (CURRENT)	PART NUMBER (SUPERSEDED)	WIRE RANGE
	MATING END	WIRE BARREL				
<p>TYPICAL CONTACT CONFIGURATION</p>	20	20	P	M39029/64-369	M24308/11-1 M24308/10-1	20-24
	20	20	S	M39029/63-368		20-24
	20	20	P	M39029/64-657		20-24
	20	20	S	M39029/63-656		20-24
	22	22D	P	M39029/58-360	M24308/13-1	22-28
	22	22D	S	M39029/57-354	M24308/12-1	22-28

TOOL SELECTION		CRIMP TOOL AND ACCESSORY					ASSEMBLY TOOLS	
BIN*	COLOR	AF8	AFM8	MH860	WA23 (POS)	WA23 (DIE)	INSTALLING	REMOVAL
369	ORANGE-BLUE-WHITE	TP585	K13-1	86-30-1			DAK145	DRK145
368	ORANGE-BLUE-GRAY	TP585	K13-1	86-30-1			or M81969/1-02	or M81969/1-02
357	BLUE-GREEN-VIOLET	TP385	K13-1	86-30-1			DAK145	DRK145
356	BLUE-GREEN-BLUE	TP385	K13-1	86-30-1			or M81969/1-02	or M81969/1-02
360	ORANGE-BLUE-BLACK		K42	86-6			DAK95-22MB	DRK95-22MB
354	ORANGE-GREEN-YELLOW		K41	86-5			or M81969/1-04	or M81969/1-04
							DAK95-22MB	DRK95-22MB
							or M81969/1-04	or M81969/1-04

*The three number suffix on M39029 series contacts is referred to as a "BIN" code. See page 22 for color stripe association.

Contact M39029/59-366 (Shielded Socket) #8 cavity, see page 79.

Contact M39029/60-367 (Shielded Pin) #8 cavity, see page 79.

Contact M39029/87 is a Thermocouple.

Contact M39029/89 is a Thermocouple.

DMC does NOT provide connectors, contacts, or wiring components. Parts are shown here for reference only.

MIL-DTL-26482 SERIES 1

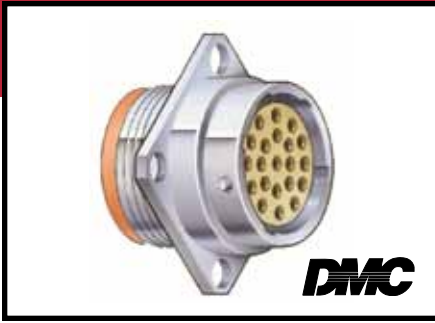

CIRCULAR BAYONET COUPLING FRONT RELEASE CONTACTS

For Backshell Torquing Tools, see page 65.

CONNECTOR P/N	DESCRIPTION	QPL SOURCES
MS3120	WALL MOUNT FLANGE RECEPTACLE	AMPHENOL, ARRAY CONNECTORS, BURNDY, ITT CANNON – ITT CANNON, MEXICO
MS3121	CABLE CONNECTING PLUG	
MS3122	BOX MOUNT FLANGE RECEPTACLE	
MS3124	JAM NUT REAR MOUNT RECEPTACLE	
MS3126	STRAIGHT PLUG	
MS3127	BOX MOUNT FLANGE RECEPTACLE	
MS3128	WALL MOUNT FLANGE RECEPTACLE	

CONTACTS	SIZE (AWG)		PIN/SOC.	PART NUMBER* (CURRENT)	PART NUMBER (SUPERSEDED)	WIRE RANGE
	MATING END	WIRE BARREL				
	12	12	P	M39029/31-234	MS3192-12-12A	12-14
	12	12	S	M39029/32-253	MS3193-12-12A	12-14
	16	16	P	M39029/31-228	MS3192-16-16A	16-20
	16	16	S	M39029/32-247	MS3193-16-16A	16-20
TYPICAL CONTACT CONFIGURATION	20	20	P	M39029/31-240	MS3192-20A-20A	20-24
	20	20	S	M39029/32-259	MS3193-20A-20A	20-24

TOOL SELECTION		CRIMP TOOL AND ACCESSORY					ASSEMBLY TOOLS	
BIN*	COLOR	AF8	AFM8	MH860	WA23 (POS)	WA23 (DIE)	INSTALLING	REMOVAL
234	RED-ORANGE-YELLOW	TH1A					DAK12B	DRK12B
253	RED-GREEN-ORANGE	TH1A					DAK12B	DRK12B
228	RED-RED-GRAY	TH1A		86-2			DAK16B	DRK16B
247	RED-YELLOW-VIOLET	TH1A		86-2			DAK16B	DRK16B
240	RED-YELLOW-BLACK	TH1A	K1S	86-1S			DAK20B**	DRK20B
259	RED-GREEN-WHITE	TH1A	K1S	86-1S			DAK20B**	DRK20B

*The three number suffix on M39029 series contacts is referred to as a "BIN" code. See page 22 for color stripe association.**

** For #20 VG26482 Contacts use DAK490 Installing Tool.

Contact M39029/23-194 to 198 (Shielded Pin) #8 cavity, Inactive.

Contact M39029/24-199 to 203 (Shielded Socket) #8 cavity, Inactive.

Contact M39029/25-204 to 206 (Shielded Pin) #12 cavity, see page 79.

Contact M39029/26-207 to 209 (Shielded Socket) #12 cavity, see page 79.

DMC does NOT provide connectors, contacts, or wiring components. Parts are shown here for reference only.

MIL-DTL-26482 SERIES 2

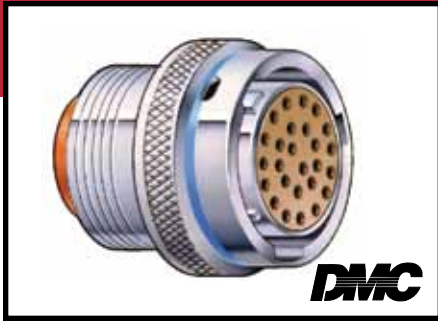

CIRCULAR BAYONET COUPLING REAR RELEASE CONTACTS

For Backshell Torquing Tools, see page 65.

CONNECTOR P/N	DESCRIPTION	QPL SOURCES
MS3470	WALL MOUNT FLANGE RECEPTACLE	AERO ELECTRIC, AMPHENOL, DEUTSCH BURNDY, ITT CANNON, HERMETIC SEAL CORPORATION
MS3471	CABLE CONNECTING PLUG	
MS3472	WIDE FLANGE WALL MOUNT RECEPTACLE	
MS3474	JAM NUT REAR MOUNT RECEPTACLE	
MS3475	PLUG RFI	
MS3476	STRAIGHT PLUG	

CONTACTS	SIZE (AWG)		PIN/SOC.	PART NUMBER* (CURRENT)	PART NUMBER (SUPERSEDED)	WIRE RANGE
	MATING END	WIRE BARREL				
<p>TYPICAL CONTACT CONFIGURATION</p>	12	12	P	M39029/4-113	M39029/4-12-12	12-14
	12	12	S	M39029/5-118	M39029/5-12-12	12-14
	12	16	P	M39029/4-114	M39029/4-12-16	16-20
	12	16	S	M39029/5-119	M39029/5-12-16	16-20
	16	16	P	M39029/4-111	M39029/4-16-16	16-20
	16	16	S	M39029/5-116	M39029/5-16-16	16-20
	16	20	P	M39029/4-112	M39029/4-16-20	20-24
	16	20	S	M39029/5-117	M39029/5-16-20	20-24
	20	20	P	M39029/4-110	M39029/4-20-20	20-24
	20	20	S	M39029/5-115	M39029/5-20-20	20-24

TOOL SELECTION		CRIMP TOOL AND ACCESSORY					ASSEMBLY TOOLS	
BIN*	COLOR	AF8	AFM8	MH860	WA23 (POS)	WA23 (DIE)	INSTALLING	REMOVAL
113	BROWN-BROWN-ORANGE	TH1A					DAK83-12B	DRK83-12B
118	BROWN-BROWN-GRAY	TH1A					DAK83-12B	DRK83-12B
114	BROWN-BROWN-YELLOW	TH1A		86-2			DAK83-12B	DRK83-12B
119	BROWN-BROWN-WHITE	TH1A		86-2			DAK83-12B	DRK83-12B
111	BROWN-BROWN-BROWN	TH1A		86-2			DAK83-16B	DRK83-16B
116	BROWN-BROWN-BLUE	TH1A		86-2			DAK83-16B	DRK83-16B
112	BROWN-BROWN-RED	TH1A		86-2			DAK83-16B	DRK83-16B
117	BROWN-BROWN-VIOLET	TH1A		86-2			DAK83-16B	DRK83-16B
110	BROWN-BROWN-BLACK	TH1A	K1S	86-1S			DAK83-20B	DRK83-20B
115	BROWN-BROWN-GREEN	TH1A	K1S	86-1S			DAK83-20B	DRK83-20B

*The three number suffix on M39029 series contacts is referred to as a "BIN" code. See page 22 for color stripe association.

Contact M39029/7-126 to 128 (Shielded Pin) #12 cavity, see page 78.

Contact M39029/8-129 to 131 (Shielded Socket) #12 cavity, see page 78.

DMC does NOT provide connectors, contacts, or wiring components. Parts are shown here for reference only.



MIL-DTL-26500

CIRCULAR THREADED OR BAYONET COUPLING FRONT RELEASE CONTACTS

For Backshell Torquing Tools, see page 65.

CONNECTOR P/N	DESCRIPTION	QPL SOURCES
MS24264	FLANGE MOUNT RECEPTACLE	PYLE-NATIONAL, AERO ELECTRIC, RMS COMPANY, CINCH CONNECTOR DIVISION AMPHENOL, HERMETIC SEAL CORPORATION, AMERICAN MICRO PRODUCTS
MS24265	SINGLE HOLE MOUNT RECEPTACLE	
MS24266	STRAIGHT PLUG	
MS27613	WALL MOUNT RECEPTACLE	
MS27614	JAM NUT	
MS27615	PLUG	

CONTACTS	SIZE (AWG)		PIN/SOC.	PART NUMBER* (CURRENT)	PART NUMBER (SUPERSEDED)	WIRE RANGE
	MATING END	WIRE BARREL				
	12	12	P	M39029/31-235	MS24254-12P	12-14
	12	12	S	M39029/32-254	MS24255-12S	12-14
	16	16	P	M39029/31-229	MS24254-16P	16-20
	16	16	S	M39029/32-248	MS24255-16S	16-20
TYPICAL CONTACT CONFIGURATION	20	20	P	M39029/31-241	MS24254-20P	20-24
	20	20	S	M39029/32-260	MS24255-20S	20-24

TOOL SELECTION		CRIMP TOOL AND ACCESSORY					ASSEMBLY TOOLS	
BIN*	COLOR	AF8	AFM8	MH860	WA23 (POS)	WA23 (DIE)	INSTALLING	REMOVAL
235	RED-ORANGE-GREEN	TH1A					DAK12B	DRK12B
254	RED-GREEN-YELLOW	TH1A					DAK12B	DRK12B
229	RED-RED-WHITE	TH1A		86-2			DAK16B	DRK16B
248	RED-YELLOW-GRAY	TH1A		86-2			DAK16B	DRK16B
241	RED-YELLOW-BROWN	TH1A	K1S	86-2			DAK20B	DRK20B
260	RED-BLUE-BLACK	TH1A	K1S	86-2			DAK20B	DRK20B

*The three number suffix on M39029 series contacts is referred to as a "BIN" code. See page 22 for color stripe association.

Contact M39029/54-342 (Shielded Pin) #12 cavity, see page 79.

Contact M39029/54-343 (Shielded Pin) #8 cavity, see page 79.

Contact M39029/55-344 (Shielded Socket) #12 cavity, see page 79.

Contact M39029/55-345 (Shielded Socket) #8 cavity, see page 79.

DMC does NOT provide connectors, contacts, or wiring components. Parts are shown here for reference only.

MIL-DTL-26518 CLASS R

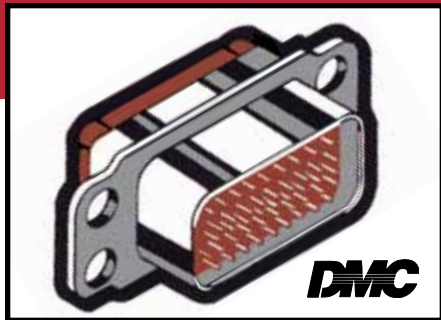

MINIATURE RECTANGULAR RACK AND PANEL FRONT RELEASE CONTACTS

CONNECTOR P/N	DESCRIPTION	QPL SOURCES
M24285	RECEPTACLE	AMPHENOL
M24286	PLUG	

CONTACTS	SIZE (AWG)		PIN/SOC.	PART NUMBER* (CURRENT)	PART NUMBER (SUPERSEDED)	WIRE RANGE
	MATING END	WIRE BARREL				
	12	12	P	M39029/31-235	MS24254-12P	12-14
	12	12	S	M39029/32-254	MS24255-12S	12-14
	16	16	P	M39029/31-229	MS24254-16P	16-20
	16	16	S	M39029/32-248	MS24255-16S	16-20
TYPICAL CONTACT CONFIGURATION	20	20	P	M39029/31-241	MS24254-20P	20-24
	20	20	S	M39029/32-260	MS24255-20S	20-24

TOOL SELECTION		CRIMP TOOL AND ACCESSORY					ASSEMBLY TOOLS	
BIN*	COLOR	AF8	AFM8	MH860	WA23 (POS)	WA23 (DIE)	INSTALLING	REMOVAL
235 254	RED-ORANGE-GREEN RED-GREEN-YELLOW	TH1A TH1A					DAK12B DAK12B	DRK12B DRK12B
229 248	RED-RED-WHITE RED-YELLOW-GRAY	TH1A TH1A		86-2 86-2			DAK16B DAK16B	DRK16B DRK16B
241 260	RED-YELLOW-BROWN RED-BLUE-BLACK	TH1A TH1A	K1S K1S	86-1S 86-1S			DAK20B DAK20B	DRK20B DRK20B

TOOL SELECTION		CRIMP TOOL AND ACCESSORY					ASSEMBLY TOOLS	
BIN*	COLOR	AF8	AFM8	MH860	WA23 (POS)	WA23 (DIE)	INSTALLING	REMOVAL
235 254	RED-ORANGE-GREEN RED-GREEN-YELLOW	TH1A TH1A					DAK12B DAK12B	DRK12B DRK12B
229 248	RED-RED-WHITE RED-YELLOW-GRAY	TH1A TH1A		86-2 86-2			DAK16B DAK16B	DRK16B DRK16B
241 260	RED-YELLOW-BROWN RED-BLUE-BLACK	TH1A TH1A	K1S K1S	86-1S 86-1S			DAK20B DAK20B	DRK20B DRK20B

*The three number suffix on M39029 series contacts is referred to as a "BIN" code. See page 22 for color stripe association.

DMC does NOT provide connectors, contacts, or wiring components. Parts are shown here for reference only.

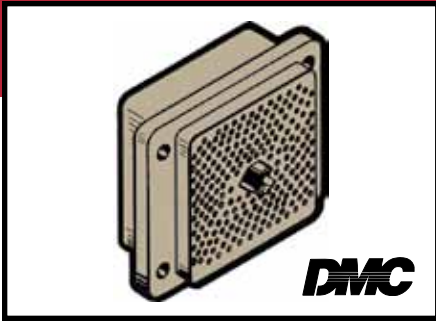

MIL-DTL-28748

RECTANGULAR RACK AND PANEL

CONNECTOR P/N	DESCRIPTION	QPL SOURCES
M28748/3	PIN CONTACTS SIZE 16 & 20	CONTINENTAL CONNECTOR CO., POSITRONIC INDUSTRIES, WINCHESTER ELECTRONICS, DELPHI CONNECTION SYSTEMS, J-TECH, INC.
M28748/4	SKT CONTACTS SIZE 16 & 20	
M28748/9	PIN CONTACTS 16 POLARIZED CENTER SCREW LOCK	
M28748/10	SKT CONTACTS 16 POLARIZED CENTER SCREW LOCK	
M28748/13	PIN CONTACTS 22	
M28748/14	SKT CONTACTS 22	

CONTACTS	SIZE (AWG)		PIN/SOC.	PART NUMBER* (CURRENT)	PART NUMBER (SUPERSEDED)	WIRE RANGE
	MATING END	WIRE BARREL				
	16	16	P	M39029/36-278	MS17807-16-16	16-20
	16	16	S	M39029/37-280	MS17808-16-16	16-20
	16	20	P	M39029/36-277	MS17807-16-20	20-24
	16	20	S	M39029/37-279	MS17808-16-20	20-24
	16	16	P	M39029/34-273	MS17803-16-16	16-20
	16	16	S	M39029/35-276	MS17804-16-16	16-20
	16	20	P	M39029/34-272	MS17803-16-20	20-24
	16	20	S	M39029/35-275	MS17804-16-20	20-24
TYPICAL CONTACT CONFIGURATION	20	20	P	M39029/34-271	MS17803-20-20	20-24
	20	20	S	M39029/35-274	MS17804-20-20	20-24
	22	22	P	M39029/34-440	M39029/34-22-22	22-26
	22	22	S	M39029/35-441	M39029/35-22-22	22-26

TOOL SELECTION		CRIMP TOOL AND ACCESSORY					ASSEMBLY TOOLS	
BIN*	COLOR	AF8	AFM8	MH860	WA23 (POS)	WA23 (DIE)	INSTALLING	REMOVAL
278	RED-VIOLET-GRAY	TH4					DAK123A	DRK124A
280	RED-GRAY-BLACK	TH4					DAK123A	DRK124A
277	RED-VIOLET-VIOLET	TH4					DAK123A	DRK124A
279	RED-VIOLET-WHITE	TH4					DAK123A	DRK124A
273	RED-VIOLET-ORANGE	TH4		86-146			DAK123A	DRK124A
276	RED-VIOLET-BLUE	TH4		86-146			DAK123A	DRK124A
272	RED-VIOLET-RED	TH4		86-146			DAK123A	DRK124A
275	RED-VIOLET-GREEN	TH4		86-146			DAK123A	DRK124A
271	RED-VIOLET-BROWN	TH4		86-146			DAK123A	DRK124A
274	RED-VIOLET-YELLOW	TH4		86-146			DAK123A	DRK124A
440	YELLOW-YELLOW-BLACK		K280				DAK123-22A	DRK124-22A
441	YELLOW-YELLOW-BROWN		K280				DAK123-22A	DRK124-22A

*The three number suffix on M39029 series contacts is referred to as a "BIN" code. See page 22 for color stripe association.

DMC does NOT provide connectors, contacts, or wiring components. Parts are shown here for reference only.



MIL-DTL-28804

RECTANGULAR POLARIZED CENTER JACKSCREW HIGH DENSITY REAR RELEASE CONTACT

CONNECTOR P/N	DESCRIPTION	QPL SOURCES
M28804/1	NON-ENVIRONMENTAL RECEPTACLE (SOCKETS)	DELPHI CONNECTION SYSTEMS
M28804/2	NON-ENVIRONMENTAL PLUG (PINS)	
M28804/3	ENVIRONMENTAL RECEPTACLE (SOCKETS)	
M28804/4	ENVIRONMENTAL PLUG (PINS)	
M28804/5	ENVIRONMENTAL RECEPTACLE (SOCKETS) (POTTING TYPE)	
M28804/6	ENVIRONMENTAL PLUG (PINS) (POTTING TYPE)	

CONTACTS	SIZE (AWG)		PIN/SOC.	PART NUMBER* (CURRENT)	PART NUMBER (SUPERSEDED)	WIRE RANGE
	MATING END	WIRE BARREL				
 <p>TYPICAL CONTACT CONFIGURATION</p>	22	22D	P	M28804/9-1		22-28
	22	22D	S	M28804/10-1		22-28

TOOL SELECTION		CRIMP TOOL AND ACCESSORY					ASSEMBLY TOOLS	
BIN*	COLOR	AF8	AFM8	MH860	WA23 (POS)	WA23 (DIE)	INSTALLING	REMOVAL
--	NONE		K473	86-193			M81969/1-04	M81969/1-04
--	NONE		K473	86-193			M81969/1-04	M81969/1-04

*The three number suffix on M39029 series contacts is referred to as a "BIN" code. See page _____ for color stripe association.

DMC does NOT provide connectors, contacts, or wiring components. Parts are shown here for reference only.

MIL-DTL-28840

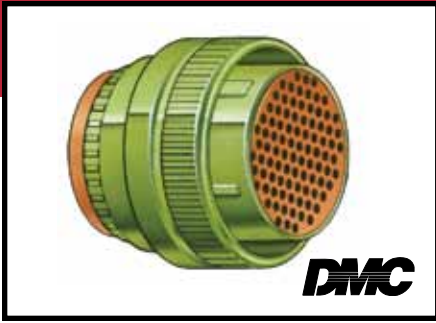

CIRCULAR – THREADED COUPLING FRONT RELEASE CONTACTS HIGH DENSITY – HIGH SHOCK

For Backshell Torquing Tools, see page 65.

CONNECTOR P/N	DESCRIPTION	QPL SOURCES
M28840/10	WALL MOUNT RECEPTACLE	GLENAIR, ITT CANNON, DELPHI CONNECTION SYSTEMS
M28840/11	CABLE CONNECTING RECEPTACLE	
M28840/12	BOX MOUNT RECEPTACLE	
M28840/14	JAM NUT MOUNT RECEPTACLE	
M28840/16	STRAIGHT PLUG	
M28840/17	PLUG OPEN WIRE ASSEMBLY	
M28840/18	PLUG OPEN WIRE ASSEMBLY 90° ELBOW	
M28840/19	PLUG OPEN WIRE ASSEMBLY 45° ELBOW	
M28840/20	WALL MOUNT ASSEMBLY STRAIGHT	
M28840/21	CABLE CONVERTING ASSEMBLY STRAIGHT	
M28840/26	PLUG ASSEMBLY STRAIGHT	
M28840/28	PLUG ASSEMBLY 90° ELBOW	
M28840/29	PLUG ASSEMBLY 45° ELBOW	

CONTACTS	SIZE (AWG)		PIN/SOC.	PART NUMBER* (CURRENT)	PART NUMBER (SUPERSEDED)	WIRE RANGE
	MATING END	WIRE BARREL				
	20	20	P	M39029/83-508	M39029/83-20-20	20-24
	20	20	S	M39029/84-509	M39029/84-20-20	20-24
	20	22	P	M39029/83-450	M39029/83-20-22	22-26
	20	22	S	M39029/84-452	M39029/84-20-22	22-26
TYPICAL CONTACT CONFIGURATION	20	28	P	M39029/83-451	M39029/83-20-28	28-32
	20	28	S	M39029/84-453	M39029/84-20-28	28-32

TOOL SELECTION		CRIMP TOOL AND ACCESSORY**				ASSEMBLY TOOLS**	
BIN*	COLOR	AF8	AFM8	MH860	39-000	INSTALLING	REMOVAL
508 509	GREEN-BLACK-GRAY GREEN-BLACK-WHITE		K534 K534		39-102 39-102	DAK55-22SA (STRAIGHT) or DAK55-22JA (OFFSET)	DRK56-22A DRK56-22A
450 452	YELLOW-GREEN-BLACK YELLOW-GREEN-RED		K534 K534		39-102 39-102	DAK55-22SA (STRAIGHT) or DAK55-22JA (OFFSET)	DRK56-22A DRK56-22A
451 453	YELLOW-GREEN-BROWN YELLOW-GREEN-ORANGE		K534 K534		39-102 39-102	DAK55-22SA (STRAIGHT) or DAK55-22JA (OFFSET)	DRK56-22A DRK56-22A

*The three number suffix on M39029 series contacts is referred to as a "BIN" code. See page 22 for color stripe association.

** See page 9 for more information on MIL-DTL-28840 Tooling.

Contact M39029/104 (Concentric Twinax pin) size 8

Contact M39029/105 (Concentric Twinax pin) size 8

DMC does NOT provide connectors, contacts, or wiring components. Parts are shown here for reference only.

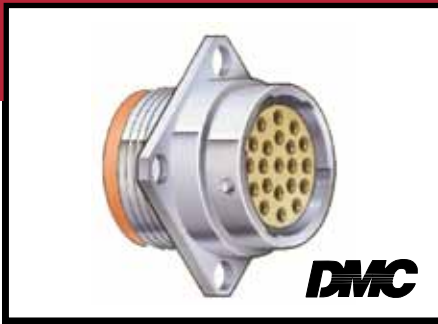

MIL-C-38300

CIRCULAR THREADED OR BAYONET COUPLING FRONT RELEASE CONTACTS

For Backshell Torquing Tools, see page 65.

CONNECTOR P/N	DESCRIPTION	QPL SOURCES
MS24264	FLANGE MOUNT RECEPTACLE	NO QPL SOURCES
MS24265	SINGLE HOLE MOUNT RECEPTACLE	
MS24266	STRAIGHT PLUG	

CONTACTS	SIZE (AWG)		PIN/SOC.	PART NUMBER* (CURRENT)	PART NUMBER (SUPERSEDED)	WIRE RANGE
	MATING END	WIRE BARREL				
 TYPICAL CONTACT CONFIGURATION	16	16	P	M39029/31-229 M39029/32-248	MS24254-16P MS24255-16S	16-20 16-20
	16	16	S			
	20	20	P	M39029/31-241 M39029/32-260	MS24254-20P MS24255-20S	20-24 20-24
	20	20	S			

TOOL SELECTION		CRIMP TOOL AND ACCESSORY					ASSEMBLY TOOLS	
BIN*	COLOR	AF8	AFM8	MH860	WA23 (POS)	WA23 (DIE)	INSTALLING	REMOVAL
229 248	RED-RED-WHITE RED-YELLOW-GRAY	TH1A TH1A		86-2 86-2			DAK16B DAK16B	DHK16B DHK16B
241 260	RED-YELLOW-BROWN RED-BLUE-BLACK	TH1A TH1A	K1S K1S	86-1S 86-1S			DAK20B DAK20B	DHK20B DHK20B

*The three number suffix on M39029 series contacts is referred to as a "BIN" code. See page 22 for color stripe association.

DMC does NOT provide connectors, contacts, or wiring components. Parts are shown here for reference only.

MIL-PRF-38999 SERIES 1

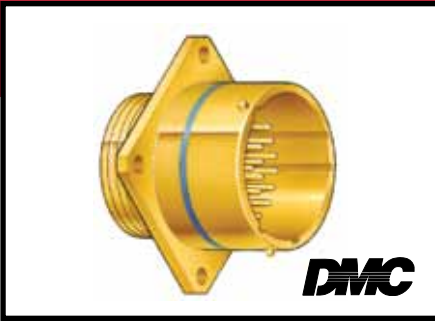

SCOOP PROOF – CIRCULAR BAYONET COUPLING REAR RELEASE CONTACTS

For Backshell Torquing Tools, see page 65.

CONNECTOR P/N	DESCRIPTION	QPL SOURCES
MS27466	WALL MOUNT FLANGE RECEPTACLE	AERO ELECTRIC, PYLE-NATIONAL, SOCAPEX, SOURIAU, DEUTSCH, BURNDY, ITT CANNON, VEAM, AMERICAN MICRO PRODUCTS, GLENAIR, HERMETIC SEAL CORPORATION, HI REL CONNECTORS, SEALTRON
MS27467	STRAIGHT PLUG	
MS27468	JAM NUT MOUNT RECEPTACLE	
MS27496	RECEPTACLE	
MS27505	BOX MOUNT FLANGE RECEPTACLE	
MS27656	BACK PANEL WALL MOUNT RECEPTACLE	

CONTACTS	SIZE (AWG)		PIN/SOC.	PART NUMBER* (CURRENT)	PART NUMBER (SUPERSEDED)	WIRE RANGE
	MATING END	WIRE BARREL				
	12	12	P	M39029/58-365	MS27493-12	12-14
	12	12	S	M39029/56-353	MS27490-12	12-14
	16	16	P	M39029/58-364	MS27493-16	16-20
	16	16	S	M39029/56-352	MS27490-16	16-20
	20	20	P	M39029/58-363	MS27493-20	20-24
	20	20	S	M39029/56-351	MS27490-20	20-24
	22	22	P	M39029/58-362	MS27493-22	22-26
	22	22	S	M39029/56-350	MS27490-22	22-26
TYPICAL CONTACT CONFIGURATION	22	22M	P	M39029/58-361	MS27493-22M	24-28
	22	22M	S	M39029/56-349	MS27490-22M	24-28
	22	22D	P	M39029/58-360	MS27493-22D	22-28
	22	22D	S	M39029/56-348	MS27490-22D	22-28
	10	10	P	M39029/58-528	—	10
	10	10	S	M39029/56-527	—	10

TOOL SELECTION		CRIMP TOOL AND ACCESSORY					ASSEMBLY TOOLS	
BIN*	COLOR	AF8	AFM8	MH860	WA23 (POS)	WA23 (DIE)	INSTALLING	REMOVAL
365	ORANGE-BLUE-GREEN	TH163					DAK95-12B	DRK95-12B
353	ORANGE-GREEN-ORANGE	TH163					DAK95-12B	DRK95-12B
364	ORANGE-BLUE-YELLOW	TH163		86-3			DAK95-16B	DRK95-16B
352	ORANGE-GREEN-RED	TH163		86-3			DAK95-16B	DRK95-16B
363	ORANGE-BLUE-ORANGE	TH163	K43	86-7			DAK95-20B	DRK95-20B
351	ORANGE-GREEN-BROWN	TH163	K43	86-7			DAK95-20B	DRK95-20B
362	ORANGE-BLUE-RED		K42	86-6			DAK95-22B	DRK95-22B
350	ORANGE-GREEN-BLACK		K40	86-4			DAK95-22B	DRK95-22B
361	ORANGE-BLUE-BROWN		K42	86-6			DAK95-22MB	DRK95-22MB
349	ORANGE-YELLOW-WHITE		K40	86-4			DAK95-22MB	DRK95-22MB
360	ORANGE-BLUE-BLACK		K42	86-6			DAK95-22MB	DRK95-22MB
348	ORANGE-YELLOW-GRAY		K40	86-4			DAK95-22MB	DRK95-22MB
528	GREEN-RED-GRAY	1716P-1 (Complete Tool)					DAK95-10B	DRK95-10B
527	GREEN-RED-VIOLET	1716P-1 (Complete Tool)					DAK95-10B	DRK95-10B

*The three number suffix on M39029 series contacts is referred to as a "BIN" code. See page 22 for color stripe association.

Contact M39029/74-423 (Shielded Socket) #12 cavity, solder.
 Contact M39029/75-416 to 422 (Shielded Socket) #12 cavity, see page 79.
 Contact M39029/76-424 to 427 (Shielded Pin) #16 cavity, see page 79.
 Contact M39029/77-428 to 432 (Shielded Socket) #16 cavity, see page 79.
 Contact M39029/78-433 to 425 (Shielded Socket) #16 cavity, see page 79.

Contact M39029/87 is a Thermocouple.
 Contact M39029/88 is a Thermocouple.
 Contact M39029/102 (Coaxial Pin) Size 12.
 Contact M39029/103 (Coaxial Socket) Size 12.

DMC does NOT provide connectors, contacts, or wiring components. Parts are shown here for reference only.

MIL-PRF-38999 SERIES 2



LOW SILHOUETTE – CIRCULAR BAYONET COUPLING REAR RELEASE CONTACTS

For Backshell Torquing Tools, see page 65.

CONNECTOR P/N	DESCRIPTION	QPL SOURCES
MS27472	WALL MOUNT FLANGE RECEPTACLE	AERO ELECTRIC, AMPHENOL, HI REL, ITT CANNON, BURNDY, AMERICAN MICRO PRODUCTS, GLENAIR, HERMETIC SEAL CORPORATION, SEALTRON, SOURIAU, VEAM
MS27473	STRAIGHT PLUG	
MS27474	JAM NUT MOUNT RECEPTACLE	
MS27499	BOX MOUNT RECEPTACLE	
MS27508	BOX MOUNT FLANGE RECEPTACLE	
MS27497	BACK PANEL WALL MOUNT RECEPTACLE	
MS27484	RFI PLUG	

CONTACTS	SIZE (AWG)		PIN/SOC.	PART NUMBER* (CURRENT)	PART NUMBER (SUPERSEDED)	WIRE RANGE
	MATING END	WIRE BARREL				
<p>TYPICAL CONTACT CONFIGURATION</p>	12	12	P	M39029/58-365	MS27493-12	12-14
	12	12	S	M39029/57-359	MS27491-12	12-14
	16	16	P	M39029/58-364	MS27493-16	16-20
	16	16	S	M39029/57-358	MS27491-16	16-20
	20	20	P	M39029/58-363	MS27493-10	20-24
	20	20	S	M39029/57-357	MS27491-20	20-24
	22	22	P	M39029/58-362	MS27493-22	22-26
	22	22	S	M39029/57-356	MS27491-22	22-26
	22	22M	P	M39029/58-361	MS27493-22M	24-28
	22	22M	S	M39029/57-355	MS27491-22M	24-28
	22	22D	P	M39029/58-360	MS27493-22D	22-28
	22	22D	S	M39029/57-354	MS27491-22D	22-28

TOOL SELECTION		CRIMP TOOL AND ACCESSORY					ASSEMBLY TOOLS	
BIN*	COLOR	AF8	AFM8	MH860	WA23 (POS)	WA23 (DIE)	INSTALLING	REMOVAL
365 359	ORANGE-BLUE-GREEN ORANGE-GREEN-WHITE	TH163 TH163					DAK95-12B DAK95-12B	DRK95-12B DRK95-12B
364 358	ORANGE-BLUE-YELLOW ORANGE-GREEN-GRAY	TH163 TH163		86-3 86-3			DAK95-16B DAK95-16B	DRK95-16B DRK95-16B
363 357	ORANGE-BLUE-ORANGE ORANGE-GREEN-VIOLET	TH163 TH163	K43 K43	86-7 86-7			DAK95-20B DAK95-20B	DRK95-20B DRK95-20B
362 356	ORANGE-BLUE-RED ORANGE-GREEN-BLUE		K42 K41	86-6 86-5			DAK95-22B DAK95-22B	DRK95-22B DRK95-22B
361 355	ORANGE-BLUE-BROWN ORANGE-GREEN-GREEN		K42 K41	86-6 86-5			DAK95-22MB DAK95-22MB	DRK95-22MB DRK95-22MB
360 354	ORANGE-BLUE-BLACK ORANGE-GREEN-YELLOW		K42 K41	86-6 86-5			DAK95-22MB DAK95-22MB	DRK95-22MB DRK95-22MB

*The three number suffix on M39029 series contacts is referred to as a "BIN" code. See page 22 for color stripe association.

Contact M39029/27-210 (Shielded Socket) #12 cavity, Inactive.
 Contact M39029/28-271 (Shielded Pin) #12 cavity, Inactive.
 Contact M39029/89 is a Thermocouple.
 Contact M39029/102 (Coaxial Pin) Size 12.

DMC does NOT provide connectors, contacts, or wiring components. Parts are shown here for reference only.

MIL-PRF-38999 SERIES 3

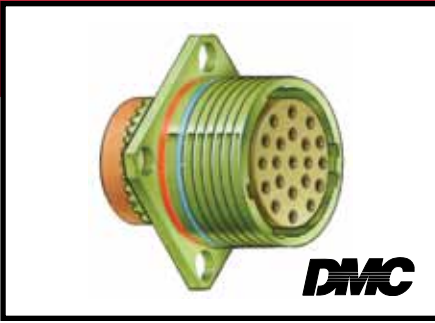

TRI-START COUPLING CIRCULAR REAR RELEASE CONTACTS

For Backshell Torquing Tools, see page 65.

CONNECTOR P/N	DESCRIPTION	QPL SOURCES
D38999/20	WALL MOUNT FLANGE RECEPTACLE	AERO ELECTRIC, AMPHENOL , PYLE-NATIONAL, DEUTSCH, BURNDY, HI REL. ITT CANNON, VEAM, G&H TECHNOLOGY, AMERICAN MICRO PRODUCTS, HERMETIC SEAL CORPORATION, SEALTRON, GLENAIR, SOURIAU, SOCAPEX, AB CONNECTORS
D38999/24 & /34	JAM NUT MOUNT RECEPTACLE	
D38999/26	STRAIGHT PLUG	
D38999/29 & /31	LAYNARD RELEASE PLUG	
D38999/35	WALL MOUNT RECEPTACLE	
D38999/36	LAYNARD RELEASE PLUG	

CONTACTS	SIZE (AWG)		PIN/SOC.	PART NUMBER* (CURRENT)	PART NUMBER (SUPERSEDED)	WIRE RANGE
	MATING END	WIRE BARREL				
<p>TYPICAL CONTACT CONFIGURATION</p>	12	12	P	M39029/58-365	MS27493-12	12-14
	12	12	S	M39029/56-353	MS27490-12	12-14
	16	16	P	M39029/58-364	MS27493-16	16-20
	16	16	S	M39029/56-352	MS27490-16	16-20
	20	20	P	M39029/58-363	MS27493-20	20-24
	20	20	S	M39029/56-351	MS27490-20	20-24
	22	22	P	M39029/58-362	MS27493-22	22-26
	22	22	S	M39029/56-350	MS27490-22	22-26
	22	22M	P	M39029/58-361	MS27493-22M	24-28
	22	22M	S	M39029/56-349	MS27490-22M	24-28
	22	22D	P	M39029/58-360	MS27493-22D	22-28
	22	22D	S	M39029/56-348	MS27490-22D	22-28
	10	10	P	M39029/58-528	—	10
	10	10	S	M39029/56-527	—	10

TOOL SELECTION		CRIMP TOOL AND ACCESSORY					ASSEMBLY TOOLS		
BIN*	COLOR	AF8	AFM8	MH860	WA23 (POS)	WA23 (DIE)	INSTALLING	REMOVAL	
365	ORANGE-BLUE-GREEN	TH163					DAK95-12B	DRK95-12B	
353	ORANGE-GREEN-ORANGE	TH163					DAK95-12B	DRK95-12B	
364	ORANGE-BLUE-YELLOW	TH163		86-3			DAK95-16B	DRK95-16B	
352	ORANGE-GREEN-RED	TH163		86-3			DAK95-16B	DRK95-16B	
363	ORANGE-BLUE-ORANGE	TH163	K43	86-7			DAK95-20B	DRK95-20B	
351	ORANGE-GREEN-BROWN	TH163	K43	86-7			DAK95-20B	DRK95-20B	
362	ORANGE-BLUE-RED		K42	86-6			DAK95-22B	DRK95-22B	
350	ORANGE-GREEN-BLACK		K40	86-4			DAK95-22B	DRK95-22B	
361	ORANGE-BLUE-BROWN		K42	86-6			DAK95-22MB	DRK95-22MB	
349	ORANGE-YELLOW-WHITE		K40	86-4			DAK95-22MB	DRK95-22MB	
360	ORANGE-BLUE-BLACK		K42	86-6			DAK95-22MB	DRK95-22MB	
348	ORANGE-YELLOW-GRAY		K40	86-4			DAK95-22MB	DRK95-22MB	
528	GREEN-RED-GRAY	1716P-1 (Complete Tool)						DAK95-10B	DRK95-10B
527	GREEN-RED-VIOLET	1716P-1 (Complete Tool)						DAK95-10B	DRK95-10B

* The three number suffix on M39029 series contacts is referred to as a "BIN" code. See page 22 for color stripe association.

Contact M39029/74-423 (Shielded Socket) #12 cavity, solder.

Contact M39029/75-416 to 422 (Shielded Socket) #12 cavity, see page 79.

Contact M39029/76-424 to 427 (Shielded Pin) #16 cavity, see page 79.

Contact M39029/77-428 to 432 (Shielded Socket) #16 cavity, see page 79.

Contact M39029/78-433 to 425 (Shielded Socket) #16 cavity, see page 79.

Contact M39029/87 is a Thermocouple.

Contact M39029/88 is a Thermocouple.

Contact M39029/90, 91, 113 and 114, see MIL-STD-1760 on page 37.

Contact M39029/102 (Coaxial Pin) Size 12.

Contact M39029/103 (Coaxial Socket) Size 12.

Contact M39029/118 and 119 High Heat/Vibration Engine Applications.

DMC does NOT provide connectors, contacts, or wiring components. Parts are shown here for reference only.



MIL-STD-1760

(MIL-PRF-38999 SERIES III VARIATION)

MIL-STD 1760 provides a common, cross platform, mechanical, electrical, and digital interface between weapons/external equipment stores and aircraft. The standard MIL-STD-1760 connector is used to transfer guidance information to weapons. The standard Connector for MIL-STD-1760 is D38999 Series III (Reference MIL-DTL-83538) Insert Arrangement #25-20. Lanyard Release Plug (/31), and Jam Nut or Flange Mount Receptacles (Also Rail Launch Configuration is available).

For Backshell Torquing Tools, see page 65.

POWER CONTACTS						
CONTACT PART NUMBER	TYPE	SIZE	CRIMP TOOL	POSITIONER	INSERTION TOOL*	REMOVAL TOOL*
M39029/58-363	Pin	20	AFM8	K43	DAK264-20	DRK264-20
M39029/56-351	Soc	20	AFM8	K43	DAK264-20	DRK264-20
M39029/58-364	Pin	16	AF8	TH163	DAK264-16	DRK264-16
M39029/56-352	Soc	16	AF8	TH163	DAK264-16	DRK264-16
M39029/58-365	Pin	12	AF8	TH163	DAK264-12	DRK264-12
M39029/56-353	Soc	12	AF8	TH163	DAK264-12	DRK264-12
M39029/58-528	Pin	10	1716P-1	N/A (Included)	DAK264-10	DRK264-10
M39029/56-527	Soc	10	1716P-1	N/A (Included)	DAK264-10	DRK264-10

COAXIAL CONTACTS								
CONTACT PART NUMBER	TYPE	SIZE	INNER CRIMP TOOL & POSITIONER		OUTER CRIMP TOOL & POSITIONER		INSERTION TOOL*	REMOVAL TOOL*
M39029/28-211	PIN	12	AFM8	K323	GS200-1	G2P330	DAK264-12	DRK264-12
M39029/75-416	Soc	12	AFM8	K323	GS200-1	G2P330	DAK264-12	DRK264-12
M39029/28-409	Pin	12	AFM8	K323	GS200-1	G2P330	DAK264-12	DRK264-12
M39029/75-417	Soc	12	AFM8	K323	GS200-1	G2P330	DAK264-12	DRK264-12

* Insertion and Removal of Contacts in MIL-STD-1760 Applications require straight tools due to the restricted access of Lanyard Release Connectors. DAK264-XX Tweezer Type Tools have the same Tip configuration as the corresponding M81969/8-XXX Tools assigned to normal Contact Insertion and Removal operations in D38999, Series III Connectors.

DATA BUS (CONCENTRIC TWINAX) CONTACTS							
CONTACT PART NUMBER	TYPE	SIZE	INNER CRIMP TOOL & POSITIONER		INTERMEDIATE AND OUTER CRIMP TOOL & DIE		
M39029/113-625**	Pin	8	AFM8	K709	HX4	Y631 Cir/Indent	Y631 Hex Cavity
M39029/114-628***	Soc	8	AFM8	K709	HX4	Y631 Cir/Indent	Y631 Hex Cavity
All Size 8 Data Bus Contacts can be inserted with the DAK264-8 and Removed with DRK264-8 Straight Metal Tools (Tweezer Type)							
Supersedes M39029/90-529, *Supersedes M39029/91-530							

DATA BUS (CONCENTRIC TWINAX) CONTACTS - ALTERNATE DESIGN MIL-STD-1760E							
CONTACT PART NUMBER	TYPE	SIZE	INNER CRIMP TOOL & POSITIONER		INTERMEDIATE AND OUTER CRIMP TOOL & DIE		
M39029/113-626	Pin	8	AFM8	K330-4	HX4	Y1064	
M39029/114-629	Soc	8	AFM8	K330-4	HX4	Y1064	
All Size 8 Data Bus Contacts can be inserted with the DAK264-8 and Removed with DRK264-8 Straight Metal Tools (Tweezer Type)							

Tool Kits are available for complete MIL-STD 1760 Wiring Support. Contact DMC for Details

Lanyard Repair Tools and Components are available from DMC. Contact Customer Service for details.

DMC does NOT provide connectors, contacts, or wiring components. Parts are shown here for reference only.

MIL-PRF-38999 SERIES 4

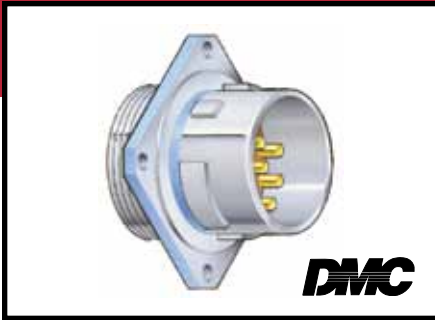

BREECH LOCK COUPLING CIRCULAR REAR RELEASE CONTACTS

For Backshell Torquing Tools, see page 65.

CONNECTOR P/N	DESCRIPTION	QPL SOURCES
D38999/40	WALL MOUNT FLANGE RECEPTACLE	DEUTSCH G&H TECHNOLOGY
D38999/42	BOX MOUNT FLANGE RECEPTACLE	
D38999/44	JAM NUT MOUNT RECEPTACLE	
D38999/46	STRAIGHT PLUG	
D38999/47	STRAIGHT PLUG	
D38999/47	CABLE MOUNT RECEPTACLE	

CONTACTS	SIZE (AWG)		PIN/SOC.	PART NUMBER* (CURRENT)	PART NUMBER (SUPERSEDED)	WIRE RANGE
	MATING END	WIRE BARREL				
	12	12	P	M39029/58-365	MS27493-12	12-14
	12	12	S	M39029/56-353	MS27490-12	12-14
	16	16	P	M39029/58-364	MS27493-16	16-20
	16	16	S	M39029/56-352	MS27490-16	16-20
	20	20	P	M39029/58-363	MS27493-20	20-24
	20	20	S	M39029/56-351	MS27490-20	20-24
	22	22	P	M39029/58-362	MS27493-22	22-26
	22	22	S	M39029/56-350	MS27490-22	22-26
	22	22M	P	M39029/58-361	MS27493-22M	24-28
	22	22M	S	M39029/56-349	MS27490-22M	24-28
	22	22D	P	M39029/58-360	MS27493-22D	22-28
	22	22D	S	M39029/56-348	MS27490-22D	22-28

TOOL SELECTION		CRIMP TOOL AND ACCESSORY					ASSEMBLY TOOLS	
BIN*	COLOR	AF8	AFM8	MH860	WA23 (POS)	WA23 (DIE)	INSTALLING	REMOVAL
365 353	ORANGE-BLUE-GREEN ORANGE-GREEN-ORANGE	TH163 TH163					DAK95-12B DAK95-12B	DRK95-12B DRK95-12B
364 352	ORANGE-BLUE-YELLOW ORANGE-GREEN-RED	TH163 TH163		86-3 86-3			DAK95-16B DAK95-16B	DRK95-16B DRK95-16B
363 351	ORANGE-BLUE-ORANGE ORANGE-GREEN-BROWN	TH163 TH163	K43 K43	86-7 86-7			DAK95-20B DAK95-20B	DRK95-20B DRK95-20B
362 350	ORANGE-BLUE-RED ORANGE-GREEN-BLACK		K42 K40	86-6 86-4			DAK95-22B DAK95-22B	DRK95-22B DRK95-22B
361 349	ORANGE-BLUE-BROWN ORANGE-YELLOW-WHITE		K42 K40	86-6 86-4			DAK95-22MB DAK95-22MB	DRK95-22MB DRK95-22MB
360 348	ORANGE-BLUE-BLACK ORANGE-YELLOW-GRAY		K42 K40	86-6 86-4			DAK95-22MB DAK95-22MB	DRK95-22MB DRK95-22MB

*The three number suffix on M39029 series contacts is referred to as a "BIN" code. See page 22 for color stripe association.

Contact M39029/74-423 (Shielded Socket) #12 cavity, solder.
 Contact M39029/75-416 to 422 (Shielded Socket) #12 cavity, see page 79.
 Contact M39029/76-424 to 427 (Shielded Pin) #16 cavity, see page 79.
 Contact M39029/77-428 to 432 (Shielded Socket) #16 cavity, see page 79.
 Contact M39029/78-433 to 425 (Shielded Socket) #16 cavity, see page 79.

Contact M39029/87 is a Thermocouple.
 Contact M39029/88 is a Thermocouple.
 Contact M39029/102 (Coaxial Pin) Size 12.
 Contact M39029/103 (Coaxial Socket) Size 12.

DMC does NOT provide connectors, contacts, or wiring components. Parts are shown here for reference only.

AS50151 (FORMERLY MIL-C-5015) SERIES 3400

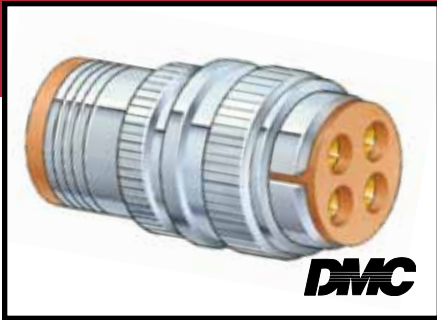

CIRCULAR THREADED COUPLING FRONT RELEASE CONTACTS

For Backshell Torquing Tools, see page 65.

CONNECTOR P/N	DESCRIPTION	QPL SOURCES
MS3400	WALL MOUNT RECEPTACLE	AERO-ELECTRIC CONNECTORS J-TECH, INC. ELECSYS, INC.
MS3401	CABLE CONNECTING RECEPTACLE	
MS3402	BOX MOUNT RECEPTACLE	
MS3404	JAM NUT MOUNT RECEPTACLE	
MS3406	STRAIGHT PLUG	
MS3408	PLUG 90°	
MS3409	PLUG 45°	
MS3412	WALL MOUNT RECEPTACLE (AN TYPE)	

CONTACTS	SIZE (AWG)		PIN/SOC.	PART NUMBER* (CURRENT)	PART NUMBER (SUPERSEDED)	WIRE RANGE	
	MATING END	WIRE BARREL					
	0	0	P	M39029/44-293	MS90453-0-0	0-2****	
	0	0	S	M39029/45-300	MS90454-0-0	0-2****	
	4	4	P	M39029/44-292	MS90453-4-0	4-6****	
	4	4	S	M39029/45-299	MS90454-4-0	4-6****	
	8	8	P	M39029/44-291	MS90453-8-0	8-10****	
	8	8	S	M39029/45-298	MS90454-8-0	8-10****	
	12	12	P	M39029/44-290	MS90453-12-12	12-14	
	12	12	S	M39029/45-297	MS90454-12-12	12-14	
	12	16	P	M39029/44-289	MS90453-12-16	16-20	
	12	16	S	M39029/45-296	MS90454-12-16	16-20	
	TYPICAL CONTACT CONFIGURATION	16	16	P	M39029/44-288	MS90453-16-16	16-20
		16	16	S	M39029/45-295	MS90454-16-16	16-20
		16	22	P	M39029/44-287	MS90453-16-22	22-26
		16	22	S	M39029/45-294	MS90454-16-22	22-26

****When using the smaller wire range, a contact bushing (also called a "crimp barrel adaptor sleeve") is required (reference AS39029/112).

TOOL SELECTION		CRIMP TOOL AND ACCESSORY					ASSEMBLY TOOLS	
BIN*	COLOR	AF8	AFM8	MH860	WA23 (POS)	WA23 (DIE)	INSTALLING	REMOVAL
293	RED-WHITE-ORANGE				WA23-13	WA23-5	DAK55-0B	DRK56-0B
300	ORANGE-BLACK-BLACK				WA23-13	WA23-5	DAK55-0B	DRK56-0B
292	RED-WHITE-RED				WA23-11	WA23-4	DAK55-4B	DRK56-4B
299	RED-WHITE-WHITE				WA23-11	WA23-4	DAK55-4B	DRK56-4B
291	RED-WHITE-BROWN				WA23-9	WA23-2	DAK55-8B	DRK56-8B
298	RED-WHITE-GRAY				WA23-9	WA23-2	DAK55-8B	DRK56-8B
290	RED-WHITE-BLACK	TH1A**					DAK55-12A**	DRK56-12A**
297	RED-WHITE-VIOLET	TH1A**					DAK55-12A**	DRK56-12A**
289	RED-GRAY-WHITE	TH1A**					DAK55-12A**	DRK56-12A**
296	RED-WHITE-BLUE	TH1A**					DAK55-12A**	DRK56-12A**
288	RED-GRAY-GRAY	TH1A***		86-2			DAK55-16A***	DRK56-16A***
295	RED-WHITE-GREEN	TH1A***		86-2			DAK55-16A***	DRK56-16A***
287	RED-GRAY-VIOLET	TH1A***		86-2			DAK55-16A***	DRK56-16A***
294	RED-WHITE-YELLOW	TH1A***		86-2			DAK55-16A***	DRK56-16A***

*The three number suffix on M39029 series contacts is referred to as a "BIN" code. See page 22 for color stripe association.

** For #12 VG95234 Contacts use the AF8 Hand Tool with the TH452 Accessory for crimping, the DAK31 Installing Tool, and the DRK152 Removal Tool.

*** For #16 VG95234 Contacts use the AF8 Hand Tool with the TH452 Accessory for crimping, the DAK32 Installing Tool, and the DRK32 Removal Tool.

DMC does NOT provide connectors, contacts, or wiring components. Parts are shown here for reference only.

AS50151 (FORMERLY MIL-C-5015) SERIES 3450

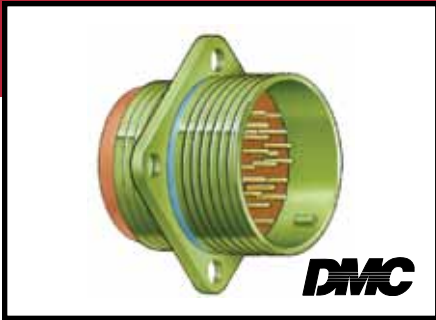

CIRCULAR THREADED COUPLING REAR RELEASE CONTACTS

For Backshell Torquing Tools, see page 65.

CONNECTOR P/N	DESCRIPTION	QPL SOURCES
MS3450	WALL MOUNT RECEPTACLE	AERO-ELECTRIC CONNECTORS ITT CANNON J-TECH, INC. AMPHENOL CONNECTORS ELECSYS, INC.
MS3451	CABLE CONNECTING RECEPTACLE	
MS3452	BOX MOUNT RECEPTACLE	
MS3454	JAM NUT MOUNT RECEPTACLE	
MS3456	STRAIGHT PLUG	
MS3459	SELF-LOCK COUPLING PLUG	

CONTACTS	SIZE (AWG)		PIN/SOC.	PART NUMBER* (CURRENT)	PART NUMBER (SUPERSEDED)	WIRE RANGE
	MATING END	WIRE BARREL				
	12	12	P	M39029/29-213 —	M39029/29-12-12 or MS3162-12-12	12-14
	12	12	S	M39029/30-219 —	M39029/30-12-12 or MS3163-12-12	12-14
	16	16	P	M39029/29-212 —	M39029/29-16-16 or MS3162-16-16	16-20
	16	16	S	M39029/30-218 —	M39029/30-16-16 or MS3163-16-16	16-20
TYPICAL CONTACT CONFIGURATION	8	8	P	M39029/29-214	M39029/29-8-8	8
	8	8	S	M39029/30-220	M39029/30-8-8	8
	4	4	P	M39029/29-215	M39029/29-4-4	4
	4	4	S	M39029/30-221	M39029/30-4-4	4
	0	0	P	M39029/29-216	M39029/29-0-0	0
	0	0	S	M39029/30-222	M39029/30-0-0	0

TOOL SELECTION		CRIMP TOOL AND ACCESSORY					ASSEMBLY TOOLS	
BIN*	COLOR	AF8	AFM8	MH860	WA23 (POS)	WA23 (DIE)	INSTALLING	REMOVAL
213	RED-BROWN-ORANGE	TH1A					DAK83-12B	DRK83-12B
219	RED-BROWN-WHITE	TH1A					DAK83-12B	DRK83-12B
212 —	RED-BROWN-RED	TH1A		86-2			DAK83-16B	DRK83-16B
218 —	RED-BROWN-GRAY	TH1A		86-2			DAK83-16B	DRK83-16B
214 220	RED-BROWN-YELLOW RED-RED-BLACK				WA23-9 WA23-9	WA23-2 WA23-2	BY HAND BY HAND	DRK250-8 OR M81969/14-06 DRK250-8 OR M81969/14-06
215 221	RED-BROWN-GREEN RED-RED-BROWN				WA23-11 WA23-11	WA23-4 WA23-4	BY HAND BY HAND	DRK250-4 OR M81969/14-07 DRK250-4 OR M81969/14-07
216 222	RED-BROWN-BLUE RED-RED-RED				WA23-13 WA23-13	WA23-5 WA23-5	BY HAND BY HAND	DRK250-0 OR M81969/14-08 DRK250-0 OR M81969/14-08

*The three number suffix on M39029 series contacts is referred to as a "BIN" code. See page 22 for color stripe association.

Contact M39029/86 is a Thermocouple.

DMC does NOT provide connectors, contacts, or wiring components. Parts are shown here for reference only.

MIL-C-81511 SERIES 1



SCOOP PROOF – CIRCULAR BAYONET COUPLING FRONT RELEASE CONTACTS

For Backshell Torquing Tools, see page 65.

CONNECTOR P/N	DESCRIPTION	QPL SOURCES
M81511/21 & /35	FLANGE MOUNT RECEPTACLE	AMPHENOL
M81511/23 & /36	JAM NUT RECEPTACLE	
M81511/25 & /37	CABLE CONNECTING RECEPTACLE	
M81511/26 & /38	STRAIGHT PLUG	

CONTACTS	SIZE (AWG)		PIN/SOC.	PART NUMBER* (CURRENT)	PART NUMBER (SUPERSEDED)	WIRE RANGE
	MATING END	WIRE BARREL				
	12	12	P	M39029/47-338	MS90461A12-12	12-14
	12	12	P	M39029/47-339	or MS90461B12-12	12-14
	12	12	S	M39029/33-269	MS3343A12-12	12-14
	12	12	S	M39029/33-270	or MS3343B12-12	12-14
	16	16	P	M39029/47-336	MS90461A16-16	16-20
	16	16	P	M39029/47-337	or MS90461B16-16	16-20
	16	16	S	M39029/33-267	MS3343A16-16	16-20
	16	16	S	M39029/33-268	or MS3343B16-16	16-20
	20	20	P	M39029/47-315	MS90461A20-20	20-24
	20	20	P	M39029/47-316	or MS90461B20-20	20-24
	20	20	S	M39029/33-265	MS3343A20-20	20-24
	20	20	S	M39029/33-266	or MS3343B20-20	20-24
	23	22	P	M39029/47-313	MS90461A23-22	22-26
	23	22	P	M39029/47-314	or MS90461B23-22	22-26
TYPICAL CONTACT CONFIGURATION	23	22	S	M39029/33-263	MS3343A23-22	22-26
	23	22	S	M39029/33-264	or MS3343B23-22	22-26
	23	28	P	M39029/47-311	MS90461A23-28	28-32
	23	28	P	M39029/47-312	or MS90461B23-28	28-32
	23	28	S	M39029/33-261	MS3343A23-28	28-32
	23	28	S	M39029/33-262	or MS3343B23-28	28-32

TOOL SELECTION		CRIMP TOOL AND ACCESSORY				ASSEMBLY TOOLS		
BIN*	COLOR	AF8	AFM8	MH860	WA23 (POS)	WA23 (DIE)	INSTALLING	REMOVAL
338	ORANGE-ORANGE-GRAY	TH199S					DAK126-12A	DRK125-12A
339	ORANGE-ORANGE-WHITE	TH199S					DAK126-12A	DRK125-12A
269	RED-BLUE-WHITE	TH199S					DAK126-12A	DRK125-12A
270	RED-VIOLET-BLACK	TH199S					DAK126-12A	DRK125-12A
336	ORANGE-ORANGE-BLUE	TH199S		86-12S			DAK126-16A	DRK125-16A
337	ORANGE-ORANGE-VIOLET	TH199S		86-12S			DAK126-16A	DRK125-16A
267	RED-BLUE-VIOLET	TH199S		86-12S			DAK126-16A	DRK125-16A
268	RED-BLUE-GRAY	TH199S		86-12S			DAK126-16A	DRK125-16A
315	ORANGE-BROWN-GREEN	TH199S		86-11S			DAK126-20A	DRK125-20A
316	ORANGE-BROWN-BLUE	TH199S		86-11S			DAK126-20A	DRK125-20A
265	RED-BLUE-GREEN	TH199S		86-11S			DAK126-20A	DRK125-20A
266	RED-BLUE-BLUE	TH199S		86-11S			DAK126-20A	DRK125-20A
313	ORANGE-BROWN-ORANGE		K60S				DAK126-23A	DRK125-23A
314	ORANGE-BROWN-YELLOW		K60S				DAK126-23A	DRK125-23A
263	RED-BLUE-ORANGE		K60S				DAK126-23A	DRK125-23A
264	RED-BLUE-YELLOW		K60S				DAK126-23A	DRK125-23A
311	ORANGE-BROWN-BROWN		K60S				DAK126-23A	DRK125-23A
312	ORANGE-BROWN-RED		K60S				DAK126-23A	DRK125-23A
261	RED-BLUE-BROWN		K60S				DAK126-23A	DRK125-23A
262	RED-BLUE-RED		K60S				DAK126-23A	DRK125-23A

Contact M39029/6-125 (Shielded Pin) #12 cavity, see page 78.
 Contact M39029/13-152 (Shielded Socket) #16 cavity, see page 78.
 Contact M39029/13-153 to 157 (Shielded Socket) #12 cavity, see page 78.
 Contact M39029/14-159 (Shielded Socket) #16 cavity, see page 78.
 Contact M39029/14-160 to 163 (Shielded Socket) #12 cavity, see page 78.

DMC does NOT provide connectors, contacts, or wiring components. Parts are shown here for reference only.

MIL-C-81511 SERIES 2



50% SCOOP PROOF – CIRCULAR BAYONET COUPLING FRONT RELEASE CONTACTS

For Backshell Torquing Tools, see page 65.

CONNECTOR P/N	DESCRIPTION	QPL SOURCES
M81511/1 & /31	FLANGE MOUNT RECEPTACLE	AMPHENOL
M81511/3 & /32	JAM NUT MOUNT RECEPTACLE	
M81511/5 & /33	CABLE CONNECTING RECEPTACLE	
M81511/6 & /34	STRAIGHT PLUG	

CONTACTS	SIZE (AWG)		PIN/SOC.	PART NUMBER* (CURRENT)	PART NUMBER (SUPERSEDED)	WIRE RANGE
	MATING END	WIRE BARREL				
 TYPICAL CONTACT CONFIGURATION	12	12	P	M39029/47-338	MS90461A12-12	12-14
	12	12	P	M39029/47-339	or MS90461A12-12	12-14
	12	12	S	M39029/46-309	MS90460A12-12	12-14
	12	12	S	M39029/46-310	or MS90460B12-12	12-14
	16	16	P	M39029/47-336	MS90461A16-16	16-20
	16	16	P	M39029/47-337	or MS90461B16-16	16-20
	16	16	S	M39029/46-307	MS90460A16-16	16-20
	16	16	S	M39029/46-308	or MS90460B16-16	16-20
	20	20	P	M39029/47-315	MS90461A20-20	20-24
	20	20	P	M39029/47-316	or MS90461B20-20	20-24
	20	20	S	M39029/46-305	MS90460A20-20	20-24
	20	20	S	M39029/46-306	or MS90460B20-20	20-24
	23	22	P	M39029/47-313	MS90461A23-22	22-26
	23	22	P	M39029/47-314	or MS90461B23-22	22-26
	23	22	S	M39029/46-303	MS90460A23-22	22-26
	23	22	S	M39029/46-304	or MS90460B23-22	22-26
	23	28	P	M39029/47-311	MS90461A23-28	28-32
	23	28	P	M39029/47-312	or MS90461B23-28	28-32
23	28	S	M39029/46-301	MS90460A23-28	28-32	
23	28	S	M39029/46-302	or MS90460B23-28	28-32	

TOOL SELECTION		CRIMP TOOL AND ACCESSORY					ASSEMBLY TOOLS	
BIN*	COLOR	AF8	AFM8	MH860	WA23 (POS)	WA23 (DIE)	INSTALLING	REMOVAL
338	ORANGE-ORANGE-GRAY	TH199S					DAK126-12A	DRK125-12A
339	ORANGE-ORANGE-WHITE	TH199S					DAK126-12A	DRK125-12A
309	ORANGE-BLACK-WHITE	TH199S					DAK126-12A	DRK129-12A
310	ORANGE-BROWN-BLACK	TH199S					DAK126-12A	DRK129-12A
336	ORANGE-ORANGE-BLUE	TH199S		86-12S			DAK126-16A	DRK125-16A
337	ORANGE-ORANGE-VIOLET	TH199S		86-12S			DAK126-16A	DRK125-16A
307	ORANGE-BLACK-VIOLET	TH199S		86-12S			DAK126-16A	DRK129-16A
308	ORANGE-BLACK-GRAY	TH199S		86-12S			DAK126-16A	DRK129-16A
315	ORANGE-BROWN-GREEN	TH199S		86-11S			DAK126-20A	DRK125-20A
316	ORANGE-BROWN-BLUE	TH199S		86-11S			DAK126-20A	DRK125-20A
305	ORANGE-BLACK-GREEN	TH199S		86-11S			DAK126-20A	DRK129-20A
306	ORANGE-BLACK-BLUE	TH199S		86-11S			DAK126-20A	DRK129-20A
313	ORANGE-BROWN-ORANGE		K60S				DAK126-23A	DRK125-23A
314	ORANGE-BROWN-YELLOW		K60S				DAK126-23A	DRK125-23A
302	ORANGE-BLACK-RED		K60S				DAK126-23A	DRK129-23A
304	ORANGE-BLACK-YELLOW		K60S				DAK126-23A	DRK129-23A
311	ORANGE-BROWN-BROWN		K60S				DAK126-23A	DRK125-23A
312	ORANGE-BROWN-RED		K60S				DAK126-23A	DRK125-23A
301	ORANGE-BLACK-BROWN		K60S				DAK126-23A	DRK129-23A
302	ORANGE-BLACK-RED		K60S				DAK126-23A	DRK129-23A

Contact M39029/6-125 (Shielded Pin) #12 cavity, see page 78.

DMC does NOT provide connectors, contacts, or wiring components. Parts are shown here for reference only.

MIL-C-81511 SERIES 3



SCOOP PROOF – CIRCULAR BAYONET COUPLING REAR RELEASE CONTACTS

For Backshell Torquing Tools, see page 65.

CONNECTOR P/N	DESCRIPTION	QPL SOURCES
M81511/41	FLANGE MOUNT RECEPTACLE	DEUTSCH
M81511/45	CABLE CONNECTING RECEPTACLE	
M81511/46	STRAIGHT PLUG	
M81511/49	JAM NUT MOUNT RECEPTACLE	

CONTACTS	SIZE (AWG)		PIN/SOC.	PART NUMBER* (CURRENT)	PART NUMBER (SUPERSEDED)	WIRE RANGE
	MATING END	WIRE BARREL				
	12	12	P	M39029/18-180	M39029/18-12-12	12-14
	12	12	S	M39029/17-175	M39029/17-12-12	12-14
	16	16	P	M39029/18-179	M39029/18-16-16	16-20
	16	16	S	M39029/17-174	M39029/17-16-16	16-20
	16	16	S	M39029/22-193	M39029/22-16-16	16-20
	20	20	P	M39029/18-178	M39029/18-20-20	16-20
	20	20	S	M39029/17-173	M39029/17-20-20	20-24
	20	20	S	M39029/22-192	M39029/22-20-20	20-24
	22	22	S	M39029/22-191	M39029/22-22-22	22-28
	22	28	S	M39029/22-190	M39029/22-22-28	28-32
TYPICAL CONTACT CONFIGURATION	23	22	P	M39029/18-177	M39029/18-23-22	22-28
	23	22	S	M39029/17-172	M39029/17-23-22	22-28
	23	28	P	M39029/18-176	M39029/18-23-28	28-32
	23	28	S	M39029/17-171	M39029/17-23-28	28-32

TOOL SELECTION		CRIMP TOOL AND ACCESSORY					ASSEMBLY TOOLS	
BIN*	COLOR	AF8	AFM8	MH860	WA23 (POS)	WA23 (DIE)	INSTALLING	REMOVAL
180	BROWN-GRAY-BLACK	TP360					M81969/16-03	M81969/16-03
175	BROWN-VIOLET-GREEN	TP365					M81969/16-03	M81969/16-03
179	BROWN-VIOLET-WHITE		K341	86-2			M81969/16-02	M81969/16-02
174	BROWN-VIOLET-YELLOW		K343	86-2			M81969/16-02	M81969/16-02
193	BROWN-WHITE-ORANGE	TH343		86-21			M81969/16-02	M81969/16-02
178	BROWN-VIOLET-GRAY		K340	86-1S			M81969/16-01	M81969/16-01
173	BROWN-VIOLET-ORANGE	TH343	K342	86-1S			M81969/16-01	M81969/16-01
192	BROWN-WHITE-RED		K503	86-20			M81969/16-01	M81969/16-01
191	BROWN-WHITE-BROWN		K330-3	86-19			M81969/16-04	M81969/16-04
190	BROWN-WHITE-BLACK		K330-3	86-19			M81969/16-04	M81969/16-04
177	BROWN-VIOLET-VIOLET		K338				M81969/16-04	M81969/16-04
172	BROWN-VIOLET-RED		K339				M81969/16-04	M81969/16-04
176	BROWN-VIOLET-BLUE		K338				M81969/16-04	M81969/16-04
171	BROWN-VIOLET-BROWN		K339				M81969/16-04	M81969/16-04

*The three number suffix on M39029 series contacts is referred to as a "BIN" code. See page 22 for color stripe association.

Contact M39029/19-181 (Shielded Pin) #16 cavity, see page 78.
 Contact M39029/19-182 to 183 (Shielded Pin) #12 cavity, see page 78.
 Contact M39029/20-184 (Shielded Socket) #16 cavity, see page 78.
 Contact M39029/20-185 to 186 (Shielded Socket) #12 cavity, see page 78.

DMC does NOT provide connectors, contacts, or wiring components. Parts are shown here for reference only.

MIL-C-81511 SERIES 4



50% SCOOP PROOF CIRCULAR REAR RELEASE CONTACTS

For Backshell Torquing Tools, see page 65.

CONNECTOR P/N	DESCRIPTION	QPL SOURCES
M81511/51	FLANGE MOUNT RECEPTACLE	DEUTSCH
M81511/53	JAM NUT MOUNT RECEPTACLE	
M81511/55	CABLE CONNECTING RECEPTACLE	
M81511/56	STRAIGHT PLUG	

CONTACTS	SIZE (AWG)		PIN/SOC.	PART NUMBER* (CURRENT)	PART NUMBER (SUPERSEDED)	WIRE RANGE
	MATING END	WIRE BARREL				
<p>TYPICAL CONTACT CONFIGURATION</p>	12	12	P	M39029/18-180	M39029/18-12-12	12-14
	12	12	S	M39029/16-170	M39029/16-12-12	12-14
	16	16	P	M39029/18-179	M39029/18-16-16	16-20
	16	16	S	M39029/16-169	M39029/16-16-16	16-20
	16	16	S	M39029/22-193	M39029/22-16-16	16-20
	20	20	P	M39029/18-178	M39029/18-20-20	20-24
	20	20	S	M39029/16-168	M39029/16-20-20	20-24
	20	20	S	M39029/22-192	M39029/22-20-20	20-24
	22	22	S	M39029/22-191	M39029/22-22-22	22-28
	22	28	S	M39029/22-190	M39029/22-22-28	28-32
	23	22	P	M39029/18-177	M39029/18-23-22	22-28
	23	22	S	M39029/16-167	M39029/16-23-22	22-28
	23	28	P	M39029/18-176	M39029/18-23-28	28-32
	23	28	S	M39029/16-166	M39029/16-23-28	28-32

TOOL SELECTION		CRIMP TOOL AND ACCESSORY					ASSEMBLY TOOLS	
BIN*	COLOR	AF8	AFM8	MH860	WA23 (POS)	WA23 (DIE)	INSTALLING	REMOVAL
180 170	BROWN-GRAY-BLACK BROWN-VIOLET-BLACK	TP360 TP360					M81969/16-03 M81969/16-03	M81969/16-03 M81969/16-03
179 169	BROWN-VIOLET-WHITE BROWN-BLUE-WHITE		K341 K341	86-2 86-2			M81969/16-02 M81969/16-02	M81969/16-02 M81969/16-02
193 178	BROWN-WHITE-ORANGE BROWN-VIOLET-GRAY	TH343	K340	86-21			M81969/16-02 M81969/16-01	M81969/16-02 M81969/16-01
168 192	BROWN-BLUE-GRAY BROWN-WHITE-RED	TH343	K340	86-20			M81969/16-01 M81969/16-01	M81969/16-01 M81969/16-01
191 190	BROWN-WHITE-BROWN BROWN-WHITE-BLACK		K330-3 K330-3	86-19 86-19			M81969/16-04 M81969/16-04	M81969/16-04 M81969/16-04
177 167	BROWN-VIOLET-VIOLET BROWN-BLUE-VIOLET		K338 K338				M81969/16-04 M81969/16-04	M81969/16-04 M81969/16-04
176 166	BROWN-VIOLET-BLUE BROWN-BLUE-BLUE		K338 K338				M81969/16-04 M81969/16-04	M81969/16-04 M81969/16-04

*The three number suffix on M39029 series contacts is referred to as a "BIN" code. See page 22 for color stripe association.

Contact M39029/21-187 (Shielded Socket) #16 cavity, see page 78.

Contact M39029/21-188 to 189 (Shielded Socket) #12 cavity, see page 78.

DMC does NOT provide connectors, contacts, or wiring components. Parts are shown here for reference only.

MIL-DTL-81659 SERIES 1

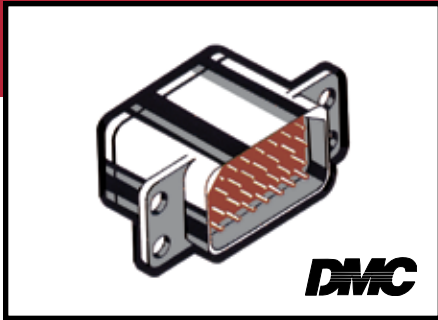

RECTANGULAR FRONT RELEASE CONTACTS

CONNECTOR P/N	DESCRIPTION	QPL SOURCES
M81659/1 THRU M81659/27	RECEPTACLE OR PLUG, TYPE 1 AND 2 CLASS 1 AND 2 SHELL DESIGNATOR A OR B	NO QPL SOURCES

CONTACTS	SIZE (AWG)		PIN/SOC.	PART NUMBER* (CURRENT)	PART NUMBER (SUPERSEDED)	WIRE RANGE
	MATING END	WIRE BARREL				
	16	16	P	M39029/2-106	M39029/2-16-16	16-20
	16	16	S	M39029/3-109	M39029/3-16-16	16-20
	20	20	P	M39029/2-105	M39029/2-20-20	20-24
	20	20	S	M39029/3-108	M39029/3-20-20	20-24
TYPICAL CONTACT CONFIGURATION	22	22	P	M39029/2-104	M39029/2-22-22	22-26
	22	22	S	M39029/3-107	M39029/3-22-22	22-26

TOOL SELECTION		CRIMP TOOL AND ACCESSORY					ASSEMBLY TOOLS	
BIN*	COLOR	AF8	AFM8	MH860	WA23 (POS)	WA23 (DIE)	INSTALLING	REMOVAL
106	BROWN-BLACK-BLUE	TH1A		86-2			DAK55-16A	DRK56-16A
109	BROWN-BLACK-WHITE	TH1A		86-2			DAK55-16A	DRK56-16A
105	BROWN-BLACK-GREEN	TH1A	K287				Consult Factory	Consult Factory
108	BROWN-BLACK-GRAY	TH1A	K287				Consult Factory	Consult Factory
104	BROWN-BLACK-YELLOW		K287				Consult Factory	Consult Factory
107	BROWN-BLACK-VIOLET		K287				Consult Factory	Consult Factory

*The three number suffix on M39029 series contacts is referred to as a "BIN" code. See page 22 for color stripe association.

DMC does NOT provide connectors, contacts, or wiring components. Parts are shown here for reference only.

MIL-DTL-81659

SERIES 2 (ARINC 404)

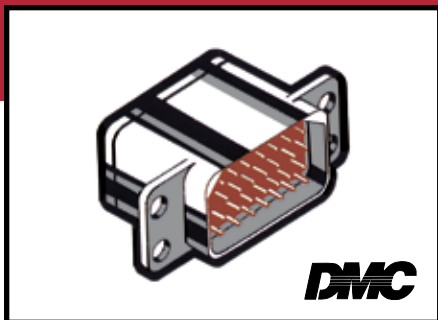

RECTANGULAR REAR RELEASE CONTACTS

CONNECTOR P/N	DESCRIPTION	QPL SOURCES
M81659/29 THRU M81659/72	RECEPTACLE OR PLUG, TYPE 2, 3 AND 4 CLASS 1 AND 2 SHELL DESIGNATOR A OR B	TYCO ELECTRONICS ITT CANNON RADIALL, S.A.

CONTACTS	SIZE (AWG)		PIN/SOC.	PART NUMBER* (CURRENT)	PART NUMBER (SUPERSEDED)	WIRE RANGE
	MATING END	WIRE BARREL				
	12	12	P	M39029/11-147	M39029/11-12-12	12-14
	12	12	S	M39029/12-151	M39029/12-12-12	12-14
	16	16	P	M39029/11-146	M39029/11-16-16	16-20
	16	16	S	M39029/12-150	M39029/12-16-16	16-20
	20	20	P	M39029/11-145	M39029/11-20-20	20-24
	20	20	S	M39029/12-149	M39029/12-20-20	20-24
TYPICAL CONTACT CONFIGURATION	22	22	P	M39029/11-144	M39029/11-22-22	22-26
	22	22	S	M39029/12-148	M39029/12-22-22	22-26

TOOL SELECTION		CRIMP TOOL AND ACCESSORY					ASSEMBLY TOOLS	
BIN*	COLOR	AF8	AFM8	MH860	WA23 (POS)	WA23 (DIE)	INSTALLING	REMOVAL
147 151	BROWN-YELLOW-VIOLET BROWN-GREEN-BROWN	TP465 TP465					BY HAND BY HAND	DRK337 DRK337
146 150	BROWN-YELLOW-BLUE BROWN-GREEN-BLACK	TH1A TH1A		86-2 86-2			M81969/1-03 M81969/1-03	M81969/1-03 M81969/1-03
145 149	BROWN-YELLOW-GREEN BROWN-YELLOW-WHITE		K13-1 K13-1	86-30-1 86-30-1			M81969/1-02 M81969/1-02	M81969/1-02 M81969/1-02
144 148	BROWN-YELLOW-YELLOW BROWN-YELLOW-GRAY		K267-1 K267-1	86-137 86-137			M81969/1-01 M81969/1-01	M81969/1-01 M81969/1-01

*The three number suffix on M39029 series contacts is referred to as a "BIN" code. See page 22 for color stripe association.

DMC does NOT provide connectors, contacts, or wiring components. Parts are shown here for reference only.

MIL-C-81703 SERIES 2

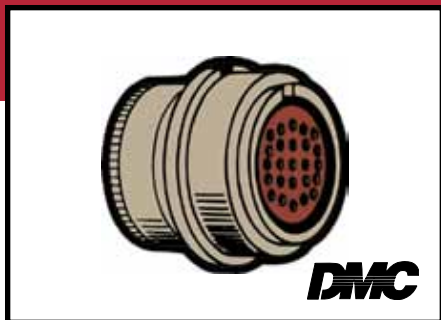

CIRCULAR RACK & PANEL OR PUSH PULL COUPLING FRONT RELEASE CONTACTS

For Backshell Torquing Tools, see page 65.

CONNECTOR P/N	DESCRIPTION	QPL SOURCES
MS3140	WALL MOUNT FLANGE RECEPTACLE	DEUTSCH
MS3144	JAM NUT MOUNT RECEPTACLE	
MS3147	STRAIGHT PLUG	
MS3148	PLUG LANYARD COUPLING	

CONTACTS	SIZE (AWG)		PIN/SOC.	PART NUMBER* (CURRENT)	PART NUMBER (SUPERSEDED)	WIRE RANGE
	MATING END	WIRE BARREL				
	12 12	12 12	P S	M39029/31-234 M39029/32-253	MS3192-12-12A MS3193-12-12A	12-14 12-14
	16 16	16 16	P S	M39029/31-228 M39029/32-247	MS3192-16-16A MS3193-16-16A	16-20 16-20
TYPICAL CONTACT CONFIGURATION	20 20	20 20	P S	M39029/31-223 M39029/32-242	MS3192-20-20A MS3193-20-20A	20-24 20-24

TOOL SELECTION		CRIMP TOOL AND ACCESSORY					ASSEMBLY TOOLS	
BIN*	COLOR	AF8	AFM8	MH860	WA23 (POS)	WA23 (DIE)	INSTALLING	REMOVAL
234 253	RED-ORANGE-YELLOW RED-GREEN-ORANGE	TH1A TH1A					DAK12B DAK12B	DRK12B DRK12B
228 247	RED-RED-GRAY RED-YELLOW-VIOLET	TH1A TH1A		86-2 86-2			DAK16B DAK16B	DRK16B DRK16B
223 242	RED-RED-ORANGE RED-YELLOW-RED	TH1A TH1A	K1S K1S	86-1S 86-1S			DAK20B DAK20B	DRK20B DRK20B

*The three number suffix on M39029 series contacts is referred to as a "BIN" code. See page 22 for color stripe association.

Contact M39029/7-126 (Shielded Pin) #12 cavity, see page 78.

DMC does NOT provide connectors, contacts, or wiring components. Parts are shown here for reference only.

MIL-C-81703 SERIES 3

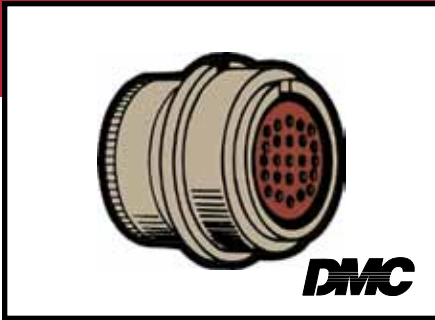

CIRCULAR RACK & PANEL OR PUSH PULL COUPLING REAR RELEASE CONTACTS

For Backshell Torquing Tools, see page 65.

CONNECTOR P/N	DESCRIPTION	QPL SOURCES
MS3445	PLUG RACK & PANEL	DEUTSCH
MS3424	WALL MOUNT FLANGE RECEPTACLE	
MS3446	PLUG RACK & PANEL	
MS3464	JAM NUT MOUNT RECEPTACLE	
MS3467	STRAIGHT PLUG	
MS3468	PLUG LANYARD COUPLING	

CONTACTS	SIZE (AWG)		PIN/SOC.	PART NUMBER* (CURRENT)	PART NUMBER (SUPERSEDED)	WIRE RANGE
	MATING END	WIRE BARREL				
	12	12	P	M39029/4-113	M39029/4-12-12	12-14
	12	12	S	M39029/5-118	M39029/5-12-12	12-14
	12	16	P	M39029/4-114	M39029/4-12-16	16-20
	12	16	S	M39029/5-119	M39029/5-12-16	16-20
	16	16	P	M39029/4-111	M39029/4-16-16	16-20
	16	16	S	M39029/5-116	M39029/5-16-16	16-20
TYPICAL CONTACT CONFIGURATION	16	20	P	M39029/4-112	M39029/4-16-20	20-24
	16	20	S	M39029/5-117	M39029/5-16-20	20-24
	20	20	P	M39029/4-110	M39029/4-20-20	20-24
	20	20	S	M39029/5-115	M39029/5-20-20	20-24

TOOL SELECTION		CRIMP TOOL AND ACCESSORY					ASSEMBLY TOOLS	
BIN*	COLOR	AF8	AFM8	MH860	WA23 (POS)	WA23 (DIE)	INSTALLING	REMOVAL
113	BROWN-BROWN-ORANGE	TH1A					DAK83-12B	DRK83-12B
118	BROWN-BROWN-GRAY	TH1A					DAK83-12B	DRK83-12B
114	BROWN-BROWN-YELLOW	TH1A					DAK83-12B	DRK83-12B
119	BROWN-BROWN-WHITE	TH1A					DAK83-12B	DRK83-12B
111	BROWN-BROWN-BROWN	TH1A		86-2			DAK83-16B	DRK83-16B
116	BROWN-BROWN-BLUE	TH1A		86-2			DAK83-16B	DRK83-16B
112	BROWN-BROWN-RED	TH1A	K1S	86-2			DAK83-16B	DRK83-16B
117	BROWN-BROWN-VIOLET	TH1A	K1S	86-2			DAK83-16B	DRK83-16B
110	BROWN-BROWN-BLACK	TH1A	K1S	86-1S			DAK83-20B	DRK83-20B
115	BROWN-BROWN-GREEN	TH1A	K1S	86-1S			DAK83-20B	DRK83-20B

*The three number suffix on M39029 series contacts is referred to as a "BIN" code. See page 22 for color stripe association.

DMC does NOT provide connectors, contacts, or wiring components. Parts are shown here for reference only.

MIL-DTL-83527 (ARINC 600)

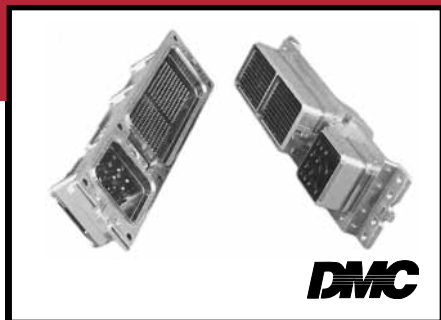

RECTANGULAR RACK AND PANEL REAR RELEASE CONTACTS

CONNECTOR P/N	DESCRIPTION	QPL SOURCES
M83527/1 THRU M83527/6	Receptacle or Plug Shell Size 2, 3, 4	Tyco Electronics (AMP) Souriau ITT Cannon

CONTACTS	SIZE (AWG)		PIN/SOC.	PART NUMBER* (CURRENT)	PART NUMBER (SUPERSEDED)	WIRE RANGE
	MATING END	WIRE BARREL				
TYPICAL CONTACT CONFIGURATION	22	22	P	M39029/93-597		22-26
	22	22	S	M39029/94-601		22-26
	20	20	P	M39029/93-598		20-24
	20	20	S	M39029/94-602		20-24
	16	16	P	M39029/93-539		16-20
	16	16	S	M39029/94-603		16-20
	12	12	P	M39029/93-540		12-14
	12	12	S	M39029/94-604		12-14

TOOL SELECTION		CRIMP TOOL AND ACCESSORY					ASSEMBLY TOOLS	
BIN*	COLOR	AF8	AFM8	MH860	WA23 (POS)	WA23 (DIE)	INSTALLING	REMOVAL
597	GREEN-WHITE-VIOLET		K267-1	86-137			M81969/1-01	M81969/1-01
601	BLUE-BLACK-BROWN		K267-1	86-137			M81969/1-01	M81969/1-01
598	GREEN-WHITE-GRAY	TP585	K13-1	86-30-1			M81969/1-02	M81969/1-02
602	BLUE-BLACK-RED	TP585	K13-1	86-30-1			M81969/1-02	M81969/1-02
539	GREEN-ORANGE-WHITE	TH1A		86-2			M81969/1-03	M81969/1-03
603	BLUE-BLACK-ORANGE	TH1A		86-2			M81969/1-03	M81969/1-03
540	GREEN-YELLOW-BLACK	TP465						DRK337
604	BLUE-BLACK-YELLOW	TP465						DRK337

*The three number suffix on M39029 series contacts is referred to as a "BIN" code. See page 22 for color stripe association.

Contact M39029/95-545 (Shielded Socket) #8 Cavity, contact DMC.
 Contact M39029/96-546 (Shielded Pin) #8 Cavity, contact DMC.
 Contact M39029/97-547 (Shielded Pin) #1 Cavity, contact DMC.
 Contact M39029/98-548 (Shielded Socket) #1 Cavity, contact DMC.
 Contact M39029/99-549 (Shielded Socket) #5 Cavity, contact DMC.
 Contact M39029/100-550 (Shielded Socket) #5 Cavity, contact DMC.

DMC does NOT provide connectors, contacts, or wiring components. Parts are shown here for reference only.

MIL-DTL-83723 SERIES 2

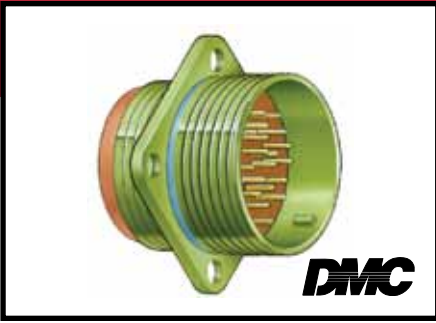

CIRCULAR THREADED COUPLING REAR RELEASE CONTACTS

For Backshell Torquing Tools, see page 65.

CONNECTOR P/N	DESCRIPTION	QPL SOURCES
M83723/17	CABLE CONNECTING RECEPTACLE SKT CONTACTS	AERO-ELECTRIC CONNECTORS ITT CANNON J-TECH, INC. AMPHENOL CONNECTORS ELECSYS, INC.
M83723/18	CABLE CONNECTING RECEPTACLE PIN CONTACTS	
M83723/19	WALL MOUNT RECEPTACLE SKT CONTACTS	
M83723/20	WALL MOUNT RECEPTACLE PIN CONTACTS	
M83723/21	BOX MOUNT RECEPTACLE SKT CONTACTS	
M83723/22	BOX MOUNT RECEPTACLE PIN CONTACTS	
M83723/23	PLUG SKT CONTACTS	
M83723/24	PLUG PIN CONTACTS	

CONTACTS	SIZE (AWG)		PIN/SOC.	PART NUMBER* (CURRENT)	PART NUMBER (SUPERSEDED)	WIRE RANGE
	MATING END	WIRE BARREL				
	12	12	P	M39029/29-213	M39029/29-12-12	12-14
	12	12	S	M39029/30-219	M39029/30-12-12	12-14
TYPICAL CONTACT CONFIGURATION	16	16	P	M39029/29-212	M39029/29-16-16	16-20
	16	16	S	M39029/30-218	M39029/30-16-16	16-20

TOOL SELECTION		CRIMP TOOL AND ACCESSORY					ASSEMBLY TOOLS	
BIN*	COLOR	AF8	AFM8	MH860	WA23 (POS)	WA23 (DIE)	INSTALLING	REMOVAL
213	RED-BROWN-ORANGE	TH1A					DAK83-12B	DRK83-12B
219	RED-BROWN-WHITE	TH1A					DAK83-12B	DRK83-12B
212	RED-BROWN-RED	TH1A		86-2			DAK83-16B	DRK83-16B
218	RED-BROWN-GRAY	TH1A		86-2			DAK83-16B	DRK83-16B

*The three number suffix on M39029 series contacts is referred to as a "BIN" code. See page 22 for color stripe association.

Contact M39029/86 is a Thermocouple.

DMC does NOT provide connectors, contacts, or wiring components. Parts are shown here for reference only.

MIL-DTL-83723 SERIES 3

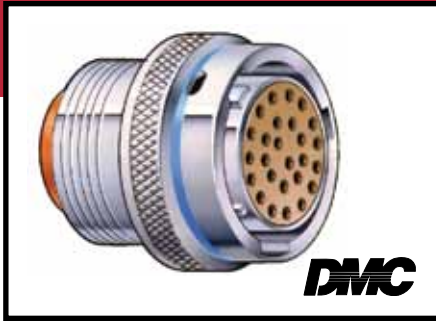

CIRCULAR BAYONET AND THREADED COUPLING REAR RELEASE CONTACTS

For Backshell Torquing Tools, see page 65.

CONNECTOR P/N	DESCRIPTION	QPL SOURCES
M83723/71, /72, /82, /83,	FLANGE MOUNT RECEPTACLE	AERO ELECTRIC, AMPHENOL, PYLE NATIONAL, DEUTSCH, J-TECH, HI-REL CONNECTORS, ITT CANNON, JOURIAU
M83723/74, 73, /85, /84	JAM NUT RECEPTACLE	
M83723/76, /75, /77	STRAIGHT PLUG, BAYONET	
M83723/87, /86, /78, /91, /95, /92, /96		

CONTACTS	SIZE (AWG)		PIN/SOC.	PART NUMBER* (CURRENT)	PART NUMBER (SUPERSEDED)	WIRE RANGE
	MATING END	WIRE BARREL				
	12	12	P	M39029/4-113	M39029/4-12-12 or M83723-33B12	12-14
	12	12	S	M39029/5-118	M39029/5-12-12 or M83723-34B12	12-14
	12 12	16 16	P S	M39029/4-114 M39029/5-119	M39029/4-12-16 or M39029/5-12-16	16-20 16-20
	16	16	P	M39029/4-111	M39029/4-16-16 or M83723-33B16	16-20
	16 16	16 16	S S	M39029/5-116 M39029/5-117	M39029/5-16-16 or M83723-34B16	16-20 16-20
	16 16	20 20	P S	M39029/4-112 M39029/5-117	M39029/4-16-20 or M39029/5-16-20	20-24 20-24
	20	20	P	M39029/4-110	M39029/4-20-20 or M83723-33B20	20-24
	TYPICAL CONTACT CONFIGURATION	20	20	S	M39029/5-115	M39029/5-20-20 or M83723-34B20

TOOL SELECTION		CRIMP TOOL AND ACCESSORY					ASSEMBLY TOOLS	
BIN*	COLOR	AF8	AFM8	MH860	WA23 (POS)	WA23 (DIE)	INSTALLING	REMOVAL
113	BROWN-BROWN-ORANGE	TH1A					DAK83-12B	DRK83-12B
118	BROWN-BROWN-GRAY	TH1A					DAK83-12B	DRK83-12B
114	BROWN-BROWN-YELLOW	TH1A		86-2			DAK83-16B	DRK83-16B
119	BROWN-BROWN-WHITE	TH1A		86-2			DAK83-16B	DRK83-16B
111	BROWN-BROWN-BROWN	TH1A		86-2			DAK83-16B	DRK83-16B
116	BROWN-BROWN-BLUE	TH1A		86-2			DAK83-16B	DRK83-16B
112	BROWN-BROWN-RED	TH1A		86-2			DAK83-16B	DRK83-16B
117	BROWN-BROWN-VIOLET	TH1A		86-2			DAK83-16B	DRK83-16B
110	BROWN-BROWN-BLACK	TH1A	K1S	86-1S			DAK83-20B	DRK83-20B
115	BROWN-BROWN-GREEN	TH1A	K1S	86-1S			DAK83-20B	DRK83-20B

Contact M39029/27-402 to 408 (Shielded Socket) #12 cavity, see page 79.
 Contact M39029/28-409 to 415 (Shielded Pin) #12 cavity, see page 79.
 Contact M39029/73-396 to 398 (Shielded Socket) #12 cavity, solder termination.
 Contact M39029/74-399 to 401 (Shielded Pin) #12 cavity, solder termination..

DMC does NOT provide connectors, contacts, or wiring components. Parts are shown here for reference only.

MIL-DTL-83733



RECTANGULAR MINIATURE RACK AND PANEL REAR RELEASE CONTACTS

CONNECTOR P/N	DESCRIPTION	QPL SOURCES
M83733/1	STANDARD HOLE MOUNT	DELPHI CONNECTION SYSTEMS
M83733/2	GUIDE PINS AND SPRING MOUNT	
M83733/3	GUIDE SOCKETS	
M83733/4	CAPTIVE SPRINGS	
M83733/5	BUSHING MOUNT	
M83733/6	CLINCH NUT MOUNT	
M83733/7	GUIDE SKTS AND SPRING MOUNT	
M83733/8	GUIDE PINS	
M83733/9	STAGGERED STANDARD HOLE MOUNT	
M83733/10	STAGGERED BUSHING MOUNT	
M83733/11	STAGGERED CLINCH NUT MOUNT	
M83733/12	STAGGERED SPRING MOUNT	

CONTACTS	SIZE (AWG)		PIN/SOC.	PART NUMBER* (CURRENT)	PART NUMBER (SUPERSEDED)	WIRE RANGE
	MATING END	WIRE BARREL				
	12	12	P	M39029/4-113	M39029/4-12-12	12-14
	12	12	S	M39029/5-118	M39029/5-12-12	12-14
	16	16	P	M39029/4-111	M39029/4-16-16	16-20
	16	16	S	M39029/5-116	M39029/5-16-16	16-20
TYPICAL CONTACT CONFIGURATION	20	20	P	M39029/4-110	M39029/4-20-20	20-24
	20	20	S	M39029/5-115	M39029/5-20-20	20-24
	22	22D	P	M39029/58-360	MS27494-22D	22-28
	22	22D	S	M39029/57-354	MS27492-22D	22-28

TOOL SELECTION		CRIMP TOOL AND ACCESSORY					ASSEMBLY TOOLS	
BIN*	COLOR	AF8	AFM8	MH860	WA23 (POS)	WA23 (DIE)	INSTALLING	REMOVAL
113	BROWN-BROWN-ORANGE	TH1A					M81969/14-04	M81969/14-04
118	BROWN-BROWN-GRAY	TH1A					M81969/14-04	M81969/14-04
111	BROWN-BROWN-BROWN	TH1A		86-2			M81969/14-03	M81969/14-03
116	BROWN-BROWN-BLUE	TH1A		86-2			M81969/14-03	M81969/14-03
110	BROWN-BROWN-BLACK	TH1A	K1S	86-1S			M81969/14-02	M81969/14-02
115	BROWN-BROWN-GREEN	TH1A	K1S	86-1S			M81969/14-02	M81969/14-02
360	ORANGE-BLUE-BLACK		K42	86-6			M81969/14-01	M81969/14-01
354	ORANGE-GREEN-YELLOW		K41	86-5			M81969/14-01	M81969/14-01

*The three number suffix on M39029 series contacts is referred to as a "BIN" code. See page 22 for color stripe association.

Contact M39029/50-340 (Shielded Pin) #12 cavity, see page 79.
 Contact M39029/51-341 (Shielded Socket) #12 cavity, see page 79.
 Contact M39029/87 is a Thermocouple.
 Contact M39029/89 is a Thermocouple.

DMC does NOT provide connectors, contacts, or wiring components. Parts are shown here for reference only.

MIL-C-85028 SERIES AS

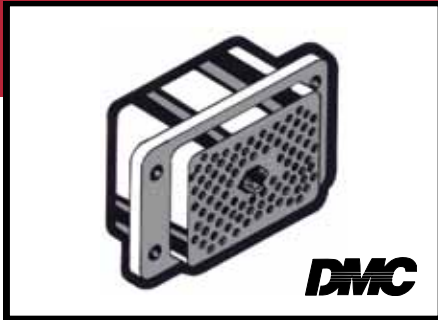

**RECTANGULAR – INDIVIDUAL CONTACT SEALING
POLARIZED CENTER JACK SCREW
PULL THRU INSERTION CONTACTS****

CONNECTOR P/N	DESCRIPTION	QPL SOURCES
M85028/1	CRIMP REMOVABLE PIN CONTACTS	DELPHI CONNECTION SYSTEMS
M85028/2	CRIMP REMOVABLE SKT CONTACTS	

CONTACTS	SIZE (AWG)		PIN/SOC.	PART NUMBER* (CURRENT)	PART NUMBER (SUPERSEDED)	WIRE RANGE	
	MATING END	WIRE BARREL					
	16	16	P	M39029/70-389	M39029/70-3	16-20	
	16	16	S	M39029/69-386	M39029/69-3	16-20	
	16	20	P	M39029/70-388	M39029/70-2	20-24	
	16	20	S	M39029/69-385	M39029/69-2	20-24	
	16	24	P	M39029/70-387	M39029/70-1	24-28	
	16	24	S	M39029/69-384	M39029/69-1	24-28	
	TYPICAL CONTACT CONFIGURATION						

TOOL SELECTION		CRIMP TOOL AND ACCESSORY					ASSEMBLY TOOLS	
BIN*	COLOR	AF8	AFM8	MH860	WA23 (POS)	WA23 (DIE)	INSTALLING**	REMOVAL
389	ORANGE-GRAY-WHITE	TP651					DAK1-16P	DRK222
386	ORANGE-GRAY-BLUE	TP651					DAK1-16S	DRK222
388	ORANGE-GRAY-GRAY	TP651					DAK1-16P	DRK222
385	ORANGE-GRAY-GREEN	TP651					DAK1-16S	DRK222
387	ORANGE-GRAY-VIOLET	TP651					DAK1-16P	DRK222
384	ORANGE-GRAY-YELLOW	TP651					DAK1-16S	DRK222

*The three number suffix on M39029 series contacts is referred to as a "BIN" code. See page 22 for color stripe association.

** Due to the sealing grommet on the contact wire barrel, it requires a special tool which is inserted through the connector, attached to the mating end of the contact, and then "pulled" into the connector. A release on the tool is actuated and the tool can be removed from the contact.

DMC does NOT provide connectors, contacts, or wiring components. Parts are shown here for reference only.

AS81714

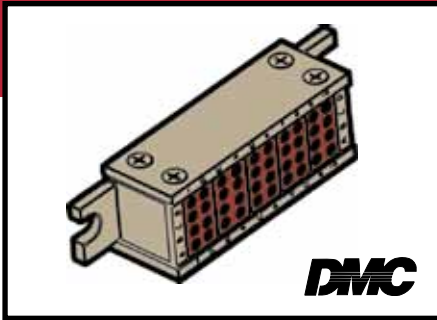

TERMINAL JUNCTIONS

CONNECTOR P/N	DESCRIPTION	QPL SOURCES
M81714/1	FEEDBACK TYPE SIZE 22	AMPHENOL-PCD, AMP TYCO DME ELECTRONICS DEUTSCH
M81714/2	FEEDBACK TYPE SIZE 20	
M81714/3	FEEDBACK TYPE SIZE 16	
M81714/4	FEEDBACK TYPE SIZE 12	
M81714/6	FEEDBACK TYPE SIZE 22	
M81714/7	FEEDBACK TYPE SIZE 20	
M81714/8	FEEDBACK TYPE SIZE 16	
M81714/9	FEEDBACK TYPE SIZE 12	
M81714/11	SPLICES	
M81714/12	DOUBLE SPLICES	
M81714/15	TERMINAL GROUNDING	

CONTACTS	SIZE (AWG)		PIN/SOC.	PART NUMBER* (CURRENT)	PART NUMBER (SUPERSEDED)	WIRE RANGE	
	MATING END	WIRE BARREL					
	12	12	P	M39029/1-103	M39029/1-12-12	12-14	
	14	16	P	M39029/1-102	M39029/1-14-16	16-20	
	16	20	P	M39029/1-101	M39029/1-16-20	20-24	
	16	22	P	M39029/1-100	M39029/1-16-22	22-26	
	20	22D	P	M39029/1-507	M39029/1-20-22D	22-28	
	TYPICAL CONTACT CONFIGURATION						

TOOL SELECTION		CRIMP TOOL AND ACCESSORY					ASSEMBLY TOOLS	
BIN*	COLOR	AF8	AFM8	MH860	WA23 (POS)	WA23 (DIE)	INSTALLING	REMOVAL
103	BROWN-BLACK-ORANGE	TH1A					DAK83-12B	DRK83-12B
102	BROWN-BLACK-RED	TH1A					DAK83-16B	DRK83-16B
101	BROWN-BLACK-BROWN	TH1A	K287				DAK83-20B	DRK83-20B
100	BROWN-BLACK-BLACK		K287				M81969/14-11	M81969/14-11
507	GREEN-BLACK-VIOLET		K496-1				M81969/14-01	M81969/14-01

*The three number suffix on M39029 series contacts is referred to as a "BIN" code. See page 22 for color stripe association.

DMC does NOT provide connectors, contacts, or wiring components. Parts are shown here for reference only.

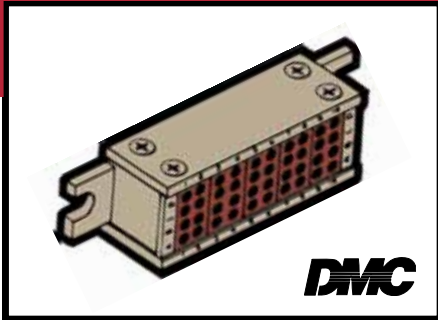

MIL-STD-1549

COMMON TERMINAL SYSTEM

CONNECTOR P/N	DESCRIPTION	QPL SOURCES
		NO QPL SOURCES

CONTACTS	SIZE (AWG)		PIN/SOC.	PART NUMBER* (CURRENT)	PART NUMBER (SUPERSEDED)	WIRE RANGE
	MATING END	WIRE BARREL				
	12	12	S	M39029/22-605	—	12-14
	16	16	S	M39029/22-193	M39029/22-16-16	16-20
	20	20	S	M39029/22-192	M39029/22-20-20	20-24
	22	22	S	M39029/22-191	M39029/22-22-22	28-32
	22	28	S	M39029/22-190	M39029/22-22-28	28-32
TYPICAL CONTACT CONFIGURATION						

TOOL SELECTION		CRIMP TOOL AND ACCESSORY					ASSEMBLY TOOLS	
BIN*	COLOR	AF8	AFM8	MH860	WA23 (POS)	WA23 (DIE)	INSTALLING	REMOVAL
605 193	BLUE-BLACK-GREEN BROWN-WHITE-ORANGE	TH343 TH343		86-21			DAK83-12B DAK83-16B	DRK83-12B DRK83-16B
192 191	BROWN-WHITE-RED BROWN-WHITE-BROWN	TH343	K503 K330-3	86-20 86-19			DAK83-20B M81969/14-01	DRK83-20B M81969/14-01
190	BROWN-WHITE-BLACK		K330-3	86-19			M81969/14-01	M81969/14-01

*The three number suffix on M39029 series contacts is referred to as a "BIN" code. See page 22 for color stripe association.

DMC does NOT provide connectors, contacts, or wiring components. Parts are shown here for reference only.

Installing and Removal Tools

DMC is dedicated to serving the connector tooling needs of the electronics industry. We, therefore, continue our connector product package with a wide variety of installing and removal tools.

Although we supply both plastic and metal tools, we recommend the use of the metal tools because of their durability.

When used properly they are more cost effective in that they withstand thousands of contact insertion and removal cycles. The trend to all metal tools is being actively encouraged by most departments of the government.

DMC installing and removal tools are of proven high quality and reliability. In addition to the tools listed in the reference table, we have many more for other connector applications.

Consult factory for details.

Illustrated on page 57 are typical rear and front release retention methods found in today's connectors.

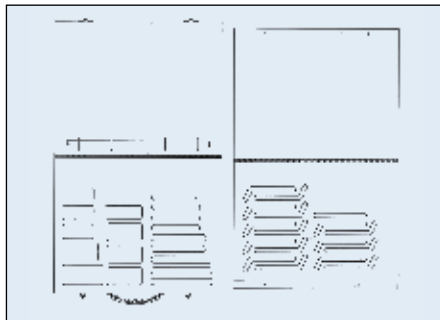

DMC1155 GENERAL PURPOSE INSERTION AND REMOVAL TOOL KIT

DMC's General Purpose Insertion and Removal Tool Kit contains metal insertion and removal tools for common Mil-Spec Circular Connectors, D-Subminiature Connector, ARINC Connectors and AS81714 terminal junctions. Consult DMC for further details.



M81969/# REFERENCE CHART

MIL+ 81969/#	SUPERCEDED MILITARY #	MIL+ 81969/#	SUPERCEDED MILITARY #	MIL+ 81969/#	SUPERCEDED MILITARY #
1-01	MS3156-22	11-01	M28731/22-01	19-09	MS24256R12
1-02	MS3156-20	13-01	M28731/21-01	19-10	MS24256RH20
	M24308/18-2	14-01	MS27534-22D	19-11	MS24256RH16
1-03	MS3156-16	14-02	MS27534-20	20-01	MS17806
	M24308/18-3		MS3447-20	27-01	MS90562-1
1-04	M24308/18-1		M83723/31-20	27-02	MS90562-2
2-01	MS3323-22	14-03	MS27534-16	27-03	MS90562-3
2-02	MS3323-20		MS3447-16	27-04	MS90562-4
2-03	MS3323-16		M83723/31-16	27-05	MS90562-5
2-04	MS3323-12	14-04	MS27534-12	27-06	MS90562-6
3-01	MS3344-23		MS3447-12	28-01	MS3178-001
3-02	MS3344-20		M83723/31-12	28-02	MS3178-002
3-03	MS3344-16	15-01	MS3483-1	29-01	MS3165-16
3-04	MS3344-12	15-02	MS3483-2	29-02	MS3165-8
3-05	MS3342-23	15-03	MS3483-3		M83723/32-08
3-06	MS3342-20	16-01	MS3160-20	29-03	MS3165-4
3-07	MS3342-16	16-02	MS3160-16		M83723/32-04
3-08	MS3342-12	16-03	MS3160-12	29-04	MS3165-0
4-01	M55301/106-01	16-04	MS3160-22		M83723/32-00
5-01	M55302/105-01	17-01	MS90455-16	30-01	MS3159-22
6-01	M21097/18-01	17-02	MS90455-12	30-02	MS3159-20
7-01	M21097/12-01	17-03	MS24256A20	30-03	MS3159-16
8-01	M55302/79-01	17-04	MS24256A16	30-04	MS3159-12
	MS27495A22M	17-05	MS24256A12	30-05	MS3448-001A
8-02	M55302/79-02	17-06	MS90455-8	30-06	MS3448-001B
	MS27495R22M	17-07	MS90455-4	30-07	MS3448-001C
8-03	MS27495A22	17-08	MS90455-0	31-01	MS18137-20-1
8-04	MS27495R22	18-01	MS17805	31-02	MS18137-20-2
8-05	MS27495A20	19-01	MS90456-16	31-03	MS18137-20-3
8-06	MS27495R20	19-02	MS90456-12	31-04	MS18137-20-4
8-07	MS27495A16	19-03	MS90456-8	31-05	MS14035-02
8-08	MS27495R16	19-04	MS90456-4	31-06	MS14035-03
8-09	MS27495A12	19-05	MS90456-0	31-07	MS14035-01
8-10	MS27495R12	19-06	MS24256R20	31-08	MS14036-01
9-01	M55302/18-01	19-07	MS24256R20	31-09	MS14036-02
10-01	M55302/86-01	19-08	MS24256R16	31-10	MS14036-03

Installing and Removal Tool Illustrations

INSTALLING TOOLS

Straight (ILL. 1) and joggled tools (ILL. 2) hold contact and wire in line with center or side of the tool handle. Tool sizes are "0" to "24" gage. Handles are color coded aluminum. Tools range from 4 1/2" to 6" long with replaceable tips.

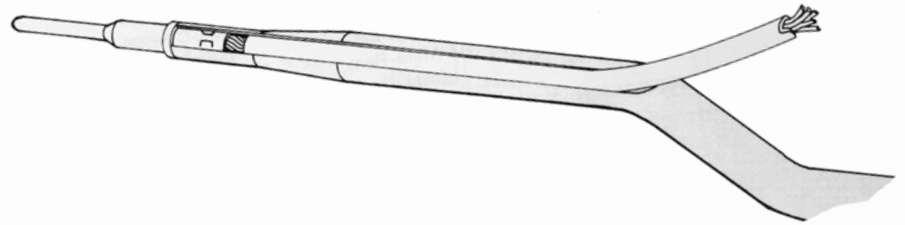
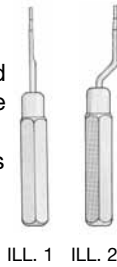

FRONT REMOVAL, REAR INSTALLING TOOLS

Both front removal (ILL. 3) and rear installing (ILL. 4) Military Standard tools offer a convenient and practical approach to servicing the MIL-C-81511, Series 1 & 2 connectors. Tools are color coded for contact size with half-inch hex metal handles.

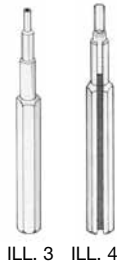

REAR REMOVAL AND INSTALLING TWEEZERS

Tools are for sizes 8 to 24 contacts. Used in NAS 1599, MIL-PRF-38999 and other rear release connectors.



REAR RELEASE PLIERS

This tool unlocks MIL-C-005015 contacts and sizes are 0, 4 and 8 gage.



FRONT RELEASE

Front release connectors are easily serviced with these military spec removal tools. Handles are color coded for contact size. Replaceable tips are available.

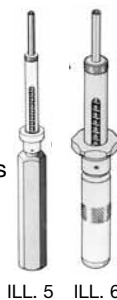

REF: MIL-C-005015, MIL-DTL-26482, MIL-C-26500, and MIL-C-26636 Connectors.

UNWIRED CONTACT TOOLS

Tool removes unwired contacts from connectors and is available in two styles. The metal style employs a locking wedge and removes contacts from terminal block as well as from the connectors.

The Military Standard tools use plastic probes which are interchangeable and available in sizes 12, 16, 20 (MS3448-001 kit) and 12 through 22 (MS3159), series NAS 1599 and MIL-C-81511, Series 3 and 4.

LONG-SLOT TOOLS

This long-slot tool illustrates the standard for MIL-C-005015 installing tools. Modified versions are available on request.

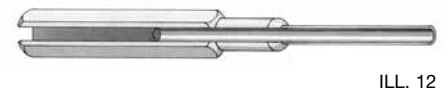

FRONT REMOVAL SPRING-LOADED PROBE CONTACT TOOLS (ILL. 7)

Employing the floating tip concept, these tools offer quality, as well as ease in operation. Body and handle are anodized aluminum alloy and color coded. Replaceable tips are available and require no special installing tools.

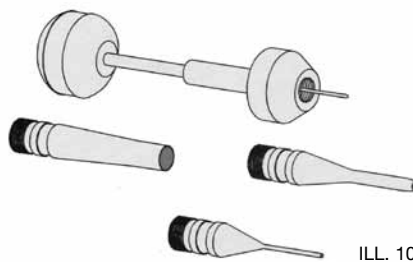

MIL-I-81969 Tool Part Number Guide

MILITARY P/N	DMC P/N	INSTALLATION OR REMOVAL	SIZE	COLOR CODE
M81969/1-01	M81969/1-01	I/R	22	GRN/WHT
M81969/1-02	M81969/1-02	I/R	20	RED/WHT
M81969/1-03	M81969/1-03	I/R	16	BLU/WHT
M81969/1-04	M81969/1-04	I/R	22D	GRN/WHT
M81969/2-01	DAK126-23A	I	22	YEL
M81969/2-02	DAK126-20A	I	20	RED
M81969/2-03	DAK126-16A	I	16	BLU
M81969/2-04	DAK126-12A	I	12	YEL
M81969/3-01	DRK129-23A	R	23	YEL
M81969/3-02	DRK129-20A	R	20	RED
M81969/3-03	DRK129-16A	R	16	BLU
M81969/3-04	DRK129-12A	R	12	YEL
M81969/3-05	DRK125-23A	R	23	YEL/BLK
M81969/3-06	DRK125-20A	R	20	RED/BLK
M81969/3-07	DRK125-16A	R	16	BLU/BLK
M81969/3-08	DRK125-12A	R	12	YEL/BLK
M81969/4-01	WRAP POST			
M81969/4-02	WRAP POST			
M81969/5-01	WRAP POST			
M81969/7-01	DAK52	I	N/A	CLEAR
M81969/8-01	DAK95-22MB	I	22D	GRN
M81969/8-02	DRK95-22MB	R	22M	GRN/WHT
M81969/8-03	DAK95-22B	I	22	BRN
M81969/8-04	DRK95-22B	R	22	BRN/WHT
M81969/8-05	DAK95-20B	I	20	RED
M81969/8-06	DRK95-20B	R	20	RED/WHT
M81969/8-07	DAK95-16B	I	16	BLU
M81969/8-08	DRK95-16B	R	16	BLU/WHT
M81969/8-09	DAK95-12B	I	12	YEL
M81969/8-10	DRK95-12B	R	12	YEL/WHT
M81969/8-11	DAK95-10B	I	10	GRN
M81969/8-12	DRK95-10B	R	10	GRN
M81969/8-13	DAK95-8B	I	8	RED
M81969/8-14	DRK95-8B	R	8	RED
M81969/8-205B	DAK83-20B	I	20	RED/BLK
M81969/8-206B	DRK83-20B	R	20	RED/WHT/ BLK
M81969/8-207	DAK83-16B	I	16	BLU/BLK
M81969/8-208	DRK83-16B	R	16	BLU/WHT/ BLK
M81969/8-209	DAK83-12B	I	12	YEL/BLK
M81969/8-210	DRK83-12B	R	12	YEL/WHT/ BLK
M81969/12-01	DRK248A	I/R	N/A	STRAIGHT
M81969/12-02	DRK246A	I/R	N/A	ANGLED
M81969/14-01	M81969/14-01	I/R	22D	GRN/WHT
M81969/14-02	M81969/14-02	I/R	20	RED/WHT
M81969/14-03	M81969/14-03	I/R	16	BLU/WHT
M81969/14-04	M81969/14-04	I/R	12	YEL/WHT
M81969/14-05	M81969/14-05	I/R	10	GRA/WHT

MILITARY P/N	DMC P/N	INSTALLATION OR REMOVAL	SIZE	COLOR CODE
M81969/14-10	M81969/14-10	I/R	20	RED/ORA
M81969/14-11	M81969/14-11	I/R	20	RED/WHT
M81969/15-01	DRK250-8	R	8	NONE
M81969/15-02	DRK250-4	R	4	NONE
M81969/15-03	DRK250-0	R	1/0	NONE
M81969/16-01	81515-20	I/R	20	RED/WHT
M81969/16-02	81515-16	I/R	16	BLU/WHT
M81969/16-03	81515-12	I/R	12	YEL/WHT
M81969/16-04	81515-23	I/R	23	GRN/WHT
M81969/17-01	DAK55-16A	I	16	BLU
M81969/17-02	DAK55-12A	I	12	YEL
M81969/17-03	DAK20B	I	20	RED
M81969/17-04	DAK16B	I	16	BLU
M81969/17-05	DAK12B	I	12	YEL
M81969/17-06	DAK55-8B	I	8	RED
M81969/17-07	DAK55-4B	I	4	BLU
M81969/17-08	DAK55-0B	I	0	YEL
M81969/17-09	DAK83S-20	I	20	RED
M81969/18-01	DAK123A	I	16/20	GRN
M81969/18-02	DAK123-22A	I	22	GOLD
M81969/19-01	DRK16B	R	16	BLU
M81969/19-02	DRK12B	R	12	YEL
M81969/19-03	DRK56-8B	R	8	RED
M81969/19-04	DRK56-4B	R	4	BLU
M81969/19-05	DRK56-0B	R	0	YEL
M81969/19-06	DRK20B	R	20	RED
M81969/19-07	DRK20A	R	20	RED
M81969/19-08	DRK16A	R	16	BLU
M81969/19-09	DRK12A	R	12	YEL
M81969/19-10	DHK20A	R	20	RED
M81969/19-11	DHK16A	R	16	BLU
M81969/20-01	DRK124A	R	16	GRN
M81969/20-02	DRK124-22A	R	22	N/A
M81969/21-01	DHK368	I/R	16	N/A
M81969/22-01	DRK222	R	16	N/A
M81969/23-01	DAK1-16P-S	I	16	N/A
M81969/23-02	DAK1-16S-S	I	16	N/A
M81969/27-01	DRK178-1A	R	4/0	N/A
M81969/27-02	DRK178-2A	R	2/0	N/A
M81969/27-03	DRK178-3A	R	1/0	N/A
M81969/27-04	DRK178-4A	R	2	N/A
M81969/27-05	DRK178-5A	R	4	N/A
M81969/27-06	DRK178-6A	R	6	N/A
M81969/28-01	DRK310	R	COAX	N/A
M81969/28-02	DRK337	R	12	N/A
M81969/28-03	DRK656	R	8	N/A
M81969/29-01	CIET16-9	R	16	BLU
M81969/28-02	DRK337	R	12	N/A

MIL-I-81969 Tool Part Number Guide

MILITARY P/N	DMC P/N	INSTALLATION OR REMOVAL	SIZE	COLOR CODE
M81969/28-03	DRK656	R	8	N/A
M81969/29-01	CIET16-9	R	16	BLU
M81969/29-02	M81969/14-06	R	8	RED
M81969/29-03	M81969/14-07	R	4	BLU
M81969/29-04	M81969/14-08	R	0	YEL
M81969/30A-01	DRK130-22A	R	22	YEL
M81969/30A-02	DRK130-20A	R	20	RED
M81969/30A-03	DRK130-16A	R	16	BLU
M81969/30A-04	DRK130-12A	R	12	YEL
M81969/30A-05	DRK110-20	R	20	RED
M81969/30A-06	DRK110-16	R	16	BLU
M81969/30A-07	DRK110-12	R	12	YEL
M81969/30B-01	DRK501B	R	22	BLK/YEL
M81969/30B-02	DRK502B	R	20	BLK/RED
M81969/30B-03	DRK503B	R	16	BLK/BLU
M81969/30B-04	DRK504B	R	12	BLK/YEL
M81969/30B-05	DRK505B	R	20	SIL/RED
M81969/30B-06	DRK506B	R	16	SIL/BLU
M81969/30B-07	DRK507B	R	12	SIL/YEL
M81969/30B-08	DRK508B	R	22D	BRN/BRN
M81969/30B-09	DRK509B	R	22M	BRN/YEL
M81969/30B-10	DRK510B	R	22	BRN/GRN
M81969/30B-11	DRK511B	R	20	BRN/RED
M81969/30B-12	DRK512B	R	16	BRN/BLU
M81969/30B-13	DRK513B	R	12	BRN/YEL

MILITARY P/N	DMC P/N	INSTALLATION OR REMOVAL	SIZE	COLOR CODE
M81969/30B-19	DRK519B	R	UNWIRED TOOL SET	
M81969/30B-20	DRK520B	R	HANDLE	
M81969/30B-21	DRK521B	R	22	YEL
M81969/30B-22	DRK522B	R	20	RED
M81969/30B-23	DRK523B	R	16	BLU
M81969/30B-24	DRK524B	R	12	YEL
M81969/30B-25	DRK525B	R	20	RED
M81969/30B-26	DRK526B	R	16	BLU
M81969/30B-27	DRK527B	R	12	YEL
M81969/30B-28	DRK528B	R	22D	BRN
M81969/30B-29	DRK529B	R	22M	YEL
M81969/30B-30	DRK530B	R	22	GRN
M81969/30B-31	DRK531B	R	20	RED
M81969/30B-32	DRK532B	R	16	BLU
M81969/30B-33	DRK533B	R	12	YEL
M81969/30B-34	DRK534B	UNWIRED REMOVAL TOOL SET		
M81969/30B-35	DRK535B	UNWIRED REMOVAL TOOL SET		
M81969/30B-36	DRK536B	UNWIRED REMOVAL TOOL SET		
M81969/33-01	DAK55-22SA	I	22	RED
M81969/33-02	DAK55-22JA	I	22	RED
M81969/34-01	DRK56-22A	R	22	RED
M81969/39-01	M81969/39-01	I/R	20	GRN/WHT

ABBREVIATIONS

I – Installation Tool
R – Removal Tool

I/R – Installation and Removal Tool
N/A – Not Available

TYPICAL FRONT RELEASE CONTACT

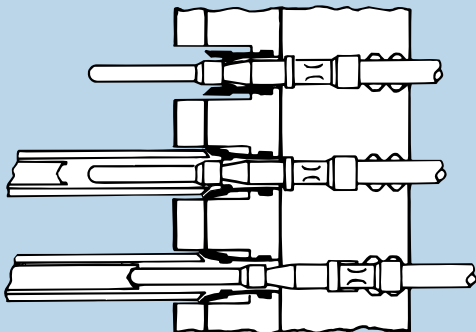

TYPICAL REAR RELEASE CONTACT

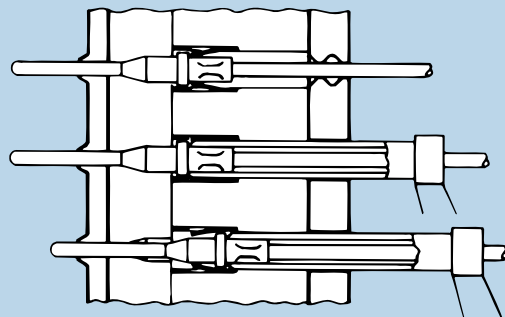

Plastic Installing and Removal Tool Part Number Guide

PLASTIC INSTALLATION & REMOVAL TOOLS			SIZE	APPLICATION	EQUIVALENT METAL TOOL	
MILITARY P/N	MANUFACTURERS P/N	COLOR CODE				
MIL-DTL-83723 All Plastic Tools	83723/31-12	Yellow - Ins.		83723	DAK83-12B	
		White - Rem.		83723	DRK83-12B	
	83723/31-16	Blue - Ins.		83723	DAK83-16B	
		White - Rem.		83723	DRK83-16B	
	83723/31-20	Red - Ins.		83723	DAK83-20B	
		White - Rem.		83723	DRK83-20B	
	83723/31-22	Brown - Ins.		83723	DAK95-22S	
		White - Rem.		83723	DRK95-22S	
	83723/31-22D	Black - Ins.		83723	DAK95-22MS	
		White - Rem.		83723	DRK95-22MS	
	MIL-I-81969 * Plastic body with metal tips	M81969/1-01*	Green - Ins.	22	MIL-DTL-24308	DAK2666J
			White - Rem.		MIL-DTL-81659 Series II	DRK2666J
M81969/1-02*		Red - Ins.	20	MIL-DTL-24308	DAK145	
		White - Rem.		MIL-DTL-81659 Series II	DRK145	
M81969/1-03*		Blue - Ins.	16	MIL-DTL-81659 Series II	DAK83-16B	
		White - Rem.			DRK83-16B	
M81969/1-04*	Green - Ins.	22D	MIL-DTL-24308	DAK95-22MB		
White - Rem.			DRK95-22MB			
MIL-I-81969 All Plastic Tools	M81969/14-01	Green - Ins. White - Rem.	22D	MIL-PRF-38999	DAK95-22MB	
				MIL-DTL-24308	DRK95-22MB	
				MIL-DTL-83733		
				MIL-T-81714		
				MIL-C-55302/68/69		
	M81969/14-02	Red - Ins. White - Rem.	20	MIL-PRF-38999	DAK95-20B	
					DRK95-20B	
				MIL-DTL-26482 Series II	DAK83-20B	
				MIL-C-81703 Series III	DRK83-20B	
				MIL-DTL-83723 Series I & III		

PLASTIC INSTALLATION & REMOVAL TOOLS			SIZE	APPLICATION	EQUIVALENT METAL TOOL
MILITARY P/N	MANUFACTURERS P/N	COLOR CODE			
MIL-I-81969 All Plastic Tools	M81969/14-02	Red - Ins.	20	MIL-DTL-83733	
		White - Rem.		MIL-T-81714 (Size 20 & 22)	
	M81969/14-03	Blue - Ins. White - Rem.	16	MIL-PRF-38999	DAK95-16B
					DRK95-16B
				AS50151 (MS3450 Series)	DAK83-16B
				MIL-DTL-26482 Series II	DRK83-16B
				MIL-C-81703 Series III	
				MIL-DTL-83723	
				MIL-T-81714	
				MIL-DTL-83733	
				MIL-DTL-81659	
	M81969/14-04	Yellow - Ins. White - Rem.	12	MIL-PRF-38999	DAK95-12B
					DRK95-12B
				AS50151 (MS3450 Series)	DAK83-12B
				MIL-C-81703 Series III	DRK83-12B
				MIL-T-81714 Series III	
				MIL-DTL-83723	
				MIL-DTL-83723	
				MIL-DTL-26482 Series II	
MIL-DTL-81659					
M81969/14-05	Gray - Ins. White - Rem.	10	MIL-PRF-38999	DAK95-10B	
				DRK95-10B	
M81969/14-06	Red - Rem.	8	AS50151	DRK250-8	
M81969/14-07	Blue - Rem.	4	AS50151	DRK250-4	
M81969/14-08	Yellow - Rem.	0	AS50151		
M81969/14-09	Brown - Ins. White - Rem.	22	MIL-C-55302/169, /171 only	DAK95-22S	
				DRK95-22S	
M81969/14-10	Red - Ins. Orange - Rem.	20	MIL-PRF-38999	DAK95-20B	
				DRK95-20B	

Verify QPL status (if required) at time of purchase.

PLASTIC INSTALLATION & REMOVAL TOOLS			SIZE	APPLICATION	EQUIVALENT METAL TOOL
MILITARY P/N	MANUFACTURERS P/N	COLOR CODE			
MIL-I-81969 All Plastic Tools	M81969/14-11	Red - Ins. White - Rem.	20	MIL-DTL-26482 Series II	DAK83-20B
				MIL-C-81703 Series III	DRK83-20B
				MIL-DTL-83723 Series I & III	
				MIL-DTL-83733	
				MIL-T-81714 (Size 20 & 22)	
	M81969/14-12	Green - Rem.	8	MIL-PRF-38999	DRK264-8
	M81969/29-01	Blue - Rem.	16	AS50151	DRK83-16B
	M81969/29-02	Red - Rem.	8	AS50151	DRK250-8
	M81969/29-03	Blue - Rem.	4	AS50151	DRK250-4
	M81969/29-04	Yellow - Rem.	0	AS50151	DRK250-0
M81969/39	Green - Ins. White - Rem.		MIL-DTL-24308 (Size 20)	DAK145	
				DRK145	
M81969/29 All Plastic Tools	MS3165-0			AS50151	DRK250-0
	MS3165-4			AS50151	DRK250-4
	MS3165-8			AS50151	DRK250-8
M81969/14 All Plastic Tools	MS27534-12	White - Rem.		MIL-PRF-38999	DRK95-12B
		Yellow - Ins.		MIL-PRF-38999	DAK95-12B
	MS27534-16	White - Rem.		MIL-PRF-38999	DRK95-16B
		Blue - Ins.		MIL-PRF-38999	DAK95-16B
	MS27534-20	White - Rem.		MIL-PRF-38999	DRK95-20B
		Red - Ins.		MIL-PRF-38999	DAK95-20B
	MS27534-22	White - Rem.		MIL-PRF-38999	DRK95-22B
		Brown - Ins.		MIL-PRF-38999	DAK95-22B
	MS27534-22D	White - Rem.		MIL-PRF-38999	DRK95-22MB
		Black - Ins.		MIL-PRF-38999	DAK95-22MB
	MS27534-22M	White - Rem.			DRK95-22MB
		Black - Ins.		MIL-PRF-38999	DAK95-22MB
	NAS 1664-12	Yellow - Ins.		NAS 1599 Connector	DAK83-12B
		White - Rem.		NAS 1599 Connector	DRK83-12B
	NAS 1664-16	Blue - Ins.		NAS 1599 Connector	DAK83-16B
White - Rem.			NAS 1599 Connector	DRK83-16B	
NAS 1664-20	Red - Ins.		NAS 1599 Connector	DAK83-20B	
	White - Rem.		NAS 1599 Connector	DRK83-20B	

PLASTIC TOOLS VS. DMC METAL TOOLS

Plastic tools are used throughout the industry. DMC's policy is to give our customers the greatest savings for the best quality tools we manufacture metal tools, although initially more costly, offer a quality product and a lower tooling cost in servicing electrical connectors. Please refer to our cross-reference lists for any plastic to metal replacement equivalents you may need.

The tools are available in two basic lengths with a metal or plastic insertion foot.

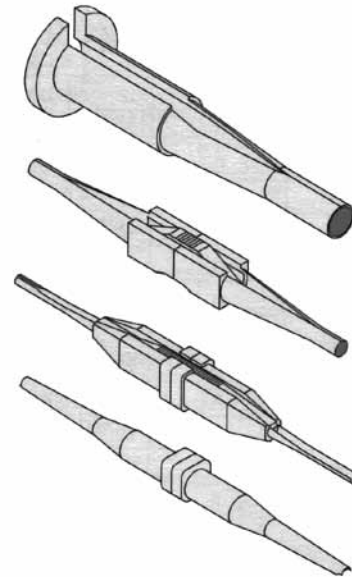

Contact Retention Test Tools for Power Contacts



Typical application showing tool testing pin contacts.

The quality assurance test most often overlooked is contact retention (proper seating of power contacts). This important test can now be performed simply and in a matter of seconds with the DMC retention testing tools for power contacts.

These tools are for checking the retention of pins and sockets in electrical connectors. The tester pin and socket tips are aluminum. All tips are replaceable. A nylon hand protector is provided with each tool. The tools can be preset at the factory to your request.

Insert tester into or over a contact so that the tester and contact are in a straight line. Hold in this position throughout the test. Use pin end with a socket contact and the socket end with a pin contact.

Apply pressure to tester until the indicator band is covered by the slide. If contact is still firmly retained, the retention is satisfactory.

TOOL PART NUMBER	RANGE POUNDS
HT250-1	1.5 THRU 3.0
HT250-2	3.2 THRU 5.5
HT250-3	4.0 THRU 8.0
HT250-4	7.0 THRU 18.0
HT250-5	17.0 THRU 25.0
HT250-6	24.0 THRU 40.0

Notice: The above part numbers apply to retention tools only (less tips). All tips must be purchased under separate part number.

CONTACT SIZE	COLOR CODE	SOCKET TESTER	PIN TESTER
8	Red	67-008-01	68-008-01
12	Yellow	67-012-01	68-012-01
16	Blue	67-016-01	68-016-01
20	Red	67-020-01	68-020-01
22, 22M, 22D	Brown	67-022-01	68-022-01
23	Black	67-023-01	68-023-01
24	Gold	67-024-01	68-024-01
26	Green	67-026-01	68-026-01

Notice: Not for use with coax or triax contacts.

CONTACT RETENTION TEST TOOL CALIBRATION EQUIPMENT

The RTCG-75 Retention Tester Calibration Gage is supplied to support in-house calibration of DMC HT250 Series Retention Testers. It incorporates the latest Alphasatron® digital test technology, and is self-contained and portable.

The tester is supplied in a protective case with calibration certificate to NIST (accuracy 0.5% full scale to 75 pounds force).



CONTACT GAGES

Contact Gages are used to determine the size of a contact's mating end (sizes 12-22) which then aids in selecting the proper installation and/or removal tooling.

Gage size of a contact is determined by matching a contact gage with the contact mating end and noting the size of the best fitting gage. To gage pins, start with the smallest gage and work your way up the scale; the first gage that fits over the pin is the size of that pin. To gage sockets, start with the largest gage and work your way down the scale; the first gage that fits inside the socket is the size of that socket.

The gage sizes are stamped on the tool and all contact gages are color coded for correct size identification. The gage end used for measuring socket contacts is marked with an "S". And the gage end used for measuring pin contacts is marked with a "P".

CAUTION: These tools are not to be used as a pin straightener.



P/N	SIZE	COLOR
CG12	12	YELLOW
CG16	16	BLUE
CG20	20	RED
CG22	22	BRONZE

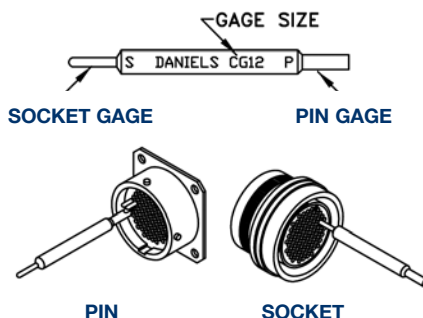

Connectors may contain several different size contacts.

Unwired Contact Removal Tools (M81969/30)

PLASTIC-PROBE UNWIRED CONTACT REMOVAL TOOLS

Removing unwired contacts can be difficult. It is very important not to damage the interfacial seal and/or connector insert when removing an unwired contact.

M81969/30 Series Plastic Probe Tools are ideal for removing unwired contacts from connectors. As the plastic probe slides into the connector, it disengages the contact locking mechanism and stretches over the contact, gripping it securely in the plastic probe.

Different colored tool probes and probe bands are used to distinguish between series and contact sizes.



PLASTIC-PROBE UNWIRED CONTACT REMOVAL TOOLS					
TOOL PART NUMBER	CONNECTOR SERIES	PROBE PART NUMBER	PROBE SIZE	PROBE COLOR	PROBE BAND COLOR
DRK50	AS50151 Series MS3450	DRK50-16-2	16	Blue	Green
		DRK50-12-2	12	Yellow	Green
DRK105	MIL-PRF-38999 Series 1 - 4 MIL-DTL-24308 MIL-DTL-55302/68 MIL-DTL-55302/71 MIL-DTL-55302/75 MIL-DTL-83733 (size 22D only)	DRK105-22M-2	22D/22M	Yellow	Brown
		DRK105-22-2	22	Green	Brown
		DRK105-20-2	20	Red	Brown
		DRK105-16-2	16	Blue	Brown
		DRK105-12-2	12	Yellow	Brown
DRK110	MIL-DTL-83733 (except size 22D) MIL-DTL-83723 Series 3 MIL-DTL-26482 Series 2 MIL-C-81511 (class "L" only)	DRK110-20-2	20	Red	Silver
		DRK110-16-2	16	Blue	Silver
		DRK110-12-2	12	Yellow	Silver
DRK130	MIL-C-81511 Series 3 & 4 (except class "L")	DRK130-22-2	22	Yellow	Black
		DRK130-20-2	20	Red	Black
		DRK130-16-2	16	Blue	Black
		DRK130-12-2	12	Yellow	Black

METAL-PROBE UNWIRED CONTACT AND BROKEN WIRE REMOVAL TOOLS

When a wire breaks inside the connector the remaining wire strands can damage the plastic tips of DMC's standard unwired contact removal tools. To solve this problem, DMC engineered the DRK276 series of metal tip removal tools for removing broken wire contacts.

Instead of different colored probes and bands, the DRK276 series removal tools have different colored tool bodies to help distinguish between tip sizes.



METAL-PROBE UNWIRED CONTACT REMOVAL TOOLS			
CONNECTOR SERIES	TOOL PART NUMBER	PROBE SIZE	BODY COLOR
MIL-PRF-38999 Series 1 - 4	DRK276-12	12	Yellow
	DRK276-16	16	Blue
	DRK276-20	20	Red
	DRK276-22	22	Brown
	DRK276-22M	22M	Green
	DRK276-22D	22D	Black

BETA Backshell Accessory Torque Tools



DMC offers a complete line of Adapter Tools and Torque Tools for holding and torquing circular connectors during the installation and removal of accessories (backshell, strain relief, or EMI/RFI shielding hardware).

The evolution of circular connectors has produced many mechanical configurations which have more precise dimensional tolerances and electrical characteristics than any other mechanical

component used in modern electrical systems. The associated tooling must meet the same level of precision to apply the connector to its intended purpose. Until now, very little attention has been focused on the tooling which is used to mount strain-relief backshells and other accessories to wired connector assemblies. This is why the BETA Connector Mate® system was developed.

This unique concept is based upon adaptor tools which are configured to mate with a specific connector series and shell size regardless of keying arrangement. They may be used simply as hand holding devices for easy tightening, or, for more exact requirements, DMC offers a wide variety of circular wrenches, strap wrenches, torque meters, and vises which can be used in a variety of combinations.

Visit our web site at www.DMCTools.com/Catalog/BETA.htm or ask for our BETA catalog.





THE PNEUMATIC BAND APPLICATION TOOL...

is a cost effective system that speeds production and improves ergonomic conditions which are present when manual tools are used. Band tension is precisely applied by a dependable pneumatic system which is consistent and repeatable.

The tension system of the pneumatic band tool is adjustable, and can be checked by use of the verification devices available from DMC. (See pages 68-69.)

The cutter blade and other components of the DMC Pneumatic Band tools are interchangeable with the same series hand tools. The rugged design and field replaceable blades make the PBT/PMBT series the best choice for production applications where EMI/RFI bands are used to terminate wire harness shielding.

The termination of EMI/RFI shielding materials is a specialized science in today's aerospace wiring systems. Application tooling is a critical factor in the overall performance of the wiring system components.

DMC has worked closely with the world's leading connector accessory manufacturers to develop the necessary tooling and accessories to meet the stringent demands of aerospace and defense system contractors. The resulting products afford the user many benefits which include:

COMPATIBILITY with all currently available termination bands and systems.

RELIABILITY through the use of commercially proven components and tool design practice.

QUALITY and REPEATABILITY which are assured by a tension system.

SERVICE AND CALIBRATION – All tools produced by DMC are adjustable, and may be easily checked and set by the user. Also, expendable components such as cut-off blades are available for simple replacement by the user.

LONG SERVICE LIFE – Properly maintained band application tools will produce thousands of reliable terminations.

AFFORDABILITY – DMC tools continue to be the most cost effective method to produce reliable wiring system shield terminations.

Models are available for .250 in. (6.350 mm) and .125 in. (3.175 mm) wide bands from all current suppliers to M85049/128.

THE HAND OPERATED BAND APPLICATION TOOL (REFERENCE AS81306/2)

is an excellent choice for many production and maintenance operations. Like the power driven models, they too can be calibrated by the user to provide reliable terminations throughout the service life.

The lightweight construction and small "nose" profile enable the user to apply termination bands in even the tightest of working areas.

ONE-STEP BANDING TOOL SYSTEM

DMC's One-Step Banding Tools are compatible with M85049/128-03, M85049/128-04, M85049/128-07 and M85049/128-08 bands. These tools tension, fold, and cut the band.

Contact DMC for One-Step Tool information and part numbers.



One-Step tool application

TWO-STEP BANDING TOOL SYSTEM

DMC's Two-Step Banding Tools are compatible with all currently available bands. These tools tension and cut the band and leave an extended cut off tab. The second step provides an extra level of security by utilizing a roll-over tool to bend the cut off tab over a full 180 degrees.

The hand tools meet the requirements of AS81306/2-01 and AS81306/2-02.



Two-Step tool application

Two-Step Banding Tool System



DBS-1100 & DBS-1200 (M81306/2-01 & M81306/2-02) HAND OPERATED BAND APPLICATION TOOLS

The DBS series Hand Actuate Tools (AS81306/2) are designed to apply all currently available AS85049/128 bands. These tools are constructed to survive the demands of production and maintenance use, and remain precisely adjusted to provide a quality band termination.

The tension-lock system gives the operator a positive indication when the precise tension has been reached.

DBS-1100 .250 Wide Band Application Tool:

- Size and Weight: 5.5" x 7.5", .36 lbs.
- Tension Range: 140–160 lbs.
- Cut-off blade: replaceable with DBS-1100-7

DBS-1200 .125 Wide Mini-Band Application Tool:

- Size and Weight: 5.5" x 7.5", .52 lbs.
- Tension Range: 80–100 lbs.
- Cut-off blade: replaceable with DBS-1100-7

PMBT1200 PNEUMATIC BAND APPLICATION TOOLS

The PBT1100 & PMBT1200 series Pneumatic Band Application Tools are lightweight, dependable, and easy to operate. Many of the components are interchangeable with the corresponding hand tool.

DMC's Pneumatic Two-Step Banding Tools are compatible with all currently available bands to M85049/128.

PBT1100 .250 Wide Band Application Tool

- Size and Weight: 8.75" L, 1.52 lbs.
- Calibration Range: 140–160 lbs.
- Hose Length: 10 foot
- Cut-off blade: replaceable with DBS-1100-7

PMBT1200 .125 Wide Mini-Band Application Tool

- Size and Weight: 8.75" L x 1.52 lbs.
- Calibration Range: 80–100 lbs.
- Hose Length: 10 foot
- Cut-off blade: replaceable with DBS-1100-7

DBS-RO3 ROLL-OVER FOR .250 WIDE BANDS APPLICATION TOOL

The DMC Roll-Over Tool (Part No. DBS-RO3) is used to fold the extended band tab securely over the buckle. Experts agree that the "folded tab" method assures maximum strength and reliability. Like other DMC Band Application Tools, the Roll-Over Tool is compatible with all currently available bands.

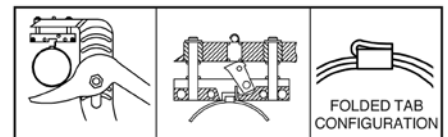

DMC also provides the DBS-RO5 Roll-Over Tool for use with .125 wide Mini-Bands. This tool is similar to the DBS-RO3 in overall size and shape.

DBS-1100 &

VERIFICATION OF TWO-STEP EMI/RFI BAND TOOLS

All the DMC Hand and Pneumatic Band Application Tools may be calibrated to insure correct band tension. The DBS-CG1 Laboratory Calibration Instrument will allow the operator to measure the exact tension produced by the tool.

A short piece of unused band material is fed into the tool far enough to fully engage the gripping mechanism. The other end is then inserted and latched into the DBS-CG1. Full tension is exerted by the tool and read directly on the precision dial indicator portion of the DBS-CG1. Simple adjustments can be made to the tool as needed. A quick release mechanism is provided to allow the operator to easily remove the tool from the DBS-CG1. A free

standing holding fixture is available (DBS-CG1-F) to aid the calibration process by securing the DBS-CG1 and banding tool in place.

Field Verification Fixtures and Go/No-Go Gages were developed to allow the user a quick means of tool tension in the field. A band is placed into the calibration fixture. The band is drawn through the tool until the nose of the banding tool is firmly against the field verification fixture. Once the full banding pressure has been applied, insert the "GO" side of the Gage into the verification slot of the field verification fixture. If it does not insert freely, the tool is exerting excessive force. Likewise, if the NO-GO probe freely enters the verification slot, the tool requires adjustment.



Band Application System Part Numbers

TWO-STEP APPLICATION TOOLS, ACCESSORIES AND COMPONENTS

.250 STANDARD WIDTH BAND TOOLS

DBS-1100	AS81306/2-XX Hand Operated Band Tool
DBS-1101	Hand Operated Band Application Tool Set (includes DBS-1100, DBS-R03)
DBS-1102	Hand Operated Band Application Tool Set (includes DBS-1100, DBS-R03, DBS-CG2 & G691)
DBS-1100-32	Tension Adjustment Key
DBS-1100-7	AS81306/2-XX Replacement Blade for .250 Band Tools
DBS-R03	Roll-Over Tool for .250 Band Tab

.125 WIDTH MINI-BAND TOOLS

DBS-1200	AS81306/2-XX Hand Operated Mini Band Tool
DBS-1201	Hand Operated Mini Band Application Tool Set (includes DBS-1200, DBS-R05)
DBS-1202	Hand Operated Mini Band Application Tool Set (includes DBS-1200, DBS-R05, DBS-CG3 & G752)
DBS-1100-7	AS81306/2-XX Replacement Blade for .125 Band Tools
DBS-R05	Roll-Over Tool for .125 Band Tab

PNEUMATIC BAND TOOLS FOR .250 WIDTH BANDS

PBT1100	Pneumatic Band Application Tool
---------	---------------------------------

PNEUMATIC BAND TOOLS FOR .125 WIDTH BANDS

PMBT1200	Pneumatic Band Application Tool
----------	---------------------------------

TOOL VERIFICATION INSTRUMENTATION

DBS-CG1	Laboratory Verification Instrument for 1100 & 1200 series band tools
DBS-CG1-F	DBS-CG1 Holding Fixture (Banding tool & DBS-CG1 not included)
DBS-CG2	Field Verification Fixture for DBS-1100
G691	Go/No-Go Gage for DBS-CG2 Fixture
DBS-CG2A	AS81306/2-XX Verification Set which includes DBS-CG2 & G691
DBS-CG3	Field Verification Fixture for DBS-1200
G752	Go/No-Go Gage for DBS-CG3 Fixture
DBS-CG3A	AS81306/2-XX Verification Set which includes DBS-CG3 & G752

BANDING APPLICATION KIT

DMC1379	AS81306/2-XX .250 Banding Tool Kit
DMC60A	Complete EMI/RFI Shielding Maintenance/Repair System (AS81306/2-XX .250 bands and tools)

* Band can also be supplied curled (contact factory)

**The DMC Two Step Band Tools are recommended for Military systems use where multi-source band procurement limits the use of the One Step Tools. Consult DMC for details.

AS85049/128 BAND IDENTIFICATION CHART

BAND P/N	CONFIGURATION	WIDTH	TERMINATE WITH
M85049/128-01	Folded Buckle, Flat	.250	2 Step Only
M85049/128-02	Folder Buckle, Curled	.250	2 Step Only
M85049/128-03	Stamped Buckle, Flat	.250	1 or 2 Step Tools
M85049/128-04	Stamped Buckle, Curled	.250	1 or 2 Step Tools
M85049/128-05	Folded Buckle, Flat	.125	2 Step Only
M85049/128-06	Folded Buckle, Curled	.125	2 Step Only
M85049/128-07	Stamped Buckle, Flat	.125	1 or 2 Step Tools
M85049/128-08	Stamped Buckle, Curled	.125	1 or 2 Step Tools

AS85049/128 TOOL IDENTIFICATION CHART

TOOL P/N	DESCRIPTION	WIDTH	DMC P/N**
AS81306/1-01	1 Step Band Tool	.250	Consult DMC
AS81306/1-02	1 Step Band Tool	.125	Consult DMC
AS81306/1-01A	Verification Inspection Gage	.250	Consult DMC
AS81306/1-02B	Verification Inspection Gage	.125	Consult DMC
AS81306/2-01	2 Step Band Tool	.250	DBS-1100**
AS81306/2-02	2 Step Band Tool	.125	DBS-1200**
AS81306/2-03	Roll Over Tool	.250	DBS-R03
AS81306/2-04	Roll Over Tool	.125	DBS-R05
AS81306/2-01A	Set: Verification Gage & Compression Fixture	.250	DBS-CG1
AS81306/2-02B	Set: Verification Gage & Compression Fixture	.125	DBS-CG2

BANDS & RINGS

4-1380	M85049/128-1 .250 wide x 14.25" long EMI/RFI Band (Flat)*
4-1553	M85049/128-2 .125 wide x 14.25" long EMI/RFI Band (Precoiled)*
4-1376	.500 Dia. Split Ring Set
4-1377	.750 Dia. Split Ring Set
4-1378	1.00 Dia. Split Ring Set
4-1379	1.50 Dia. Split Ring Set



The **DBS-CG1-F** holding fixture secures the laboratory calibration instrument and banding tool in place during calibration. This fixture only works with the DBS-CG1 Calibration Instrument. (Banding tools and DBS-CG1 are sold separately.)

MODELS: MH801, MH802, MH803, MH804, GS100-1 & GS200-1



When special conditions call for a new tool design, we make every effort to utilize the components of existing tools which have been proven reliable both in field use and controlled test programs.

Such is the case with this tool series. The design of certain shielded contacts requires two additional crimping operations. One for the shield crimp sleeve, the other for the outer body. All of the tools give a concentric circular crimp configuration required by certain shielded contacts to insure compatibility with connector inserts and installing or removal tools in rear release applications, and/or maintain consistent electric impedance. Thus an indenter pattern which conforms to the appropriate military drawing (see chart for specific part numbers) was adapted to our familiar standard and miniature tool frames. (Note: On the MH801 MH802, MH803, and MH804 tools, in addition to the four opposing indenters these tools also have four retainers which encompass the contact prior to the initiation of the crimping operation thus assuring concentricity.)

A full complement of positioners, inspection gages, and other accessories are available for these tool frames. The GS100-1 & GS200-1 tools are approximately 9 3/4" x 2 1/2" x 1 1/4" and weigh 15 oz each. The MH801, MH802, MH803, & MH804 tools are 6 3/4" in length and weigh approximately 10 oz each.

The technical section on pages 78 to 79 list the part numbers of standard M39029 contacts which require these tools; however, the concept may be adapted to other applications. Consult factory for specific details.

Pneumatic versions of these tools are also available. See page 12 or our Web site for details.

MILITARY P/N	DMC P/N	DESCRIPTION	NSN	PURPOSE
M22520/4-01	GS100-1	TOOL FRAME	5120-01-335-8576	
M22520/4-02	GP295	POSITIONER	5120-01-335-8640	MIL-C-39029/76 Pin, /77 Skt, /78 Skt
	GS100	TOOL FRAME & POSITIONER		
M22520/3-2	G120	GAGE	5220-00-116-1911	
	WA27T	PNEUMATIC TOOL FRAME		
M22520/31-01	GS200-1	TOOL FRAME	5120-01-335-8577	
M22520/31-02	G2P330	POSITIONER	5120-01-416-4799	MIL-C-39029/27 Skt, /28 Pin, /75 Skt
	GS200	TOOL FRAME & POSITIONER	5120-00-117-4709	
M22520/3-15	G443	GAGE	5220-01-518-3433	
	WA27R	PNEUMATIC TOOL FRAME		
M22520/19-01	MH801	TOOL FRAME	5120-00-124-3490	
M22520/19-02	D16P-1M	POSITIONER	5120-00-124-3351	MIL-C-39029/19 Pin,
M22520/19-03	D16S-1M	POSITIONER	5120-00-124-3341	MIL-C-39029/21 Skt
M22520/19-04	D16LS-1M	POSITIONER	5120-01-335-8644	MIL-C-39029/20 Skt
M22520/3-4	G256	GAGE (INDENTERS)	--	
M22520/3-5	G257	GAGE (RETAINERS)	--	
M22520/20-01	MH802	TOOL FRAME	5120-00-124-3469	
M22520/20-02	D16/1-1M	POSITIONER	5120-00-124-3147	MIL-C-39029/19 Pin, 21 SKT
M22520/20-03	D16/2-1M	POSITIONER	5120-00-124-3142	MIL-C-39029/20 Skt, 21 Skt
M22520/3-6	G258	GAGE (RETAINERS)	--	
M22520/21-01	MH803	TOOL FRAME	5120-00-124-3484	
M22520/21-02	D12P-1M	POSITIONER	5120-00-124-3381	MIL-C-39029/19 Pin
M22520/21-03	D12S-1M	POSITIONER	5120-00-124-3384	MIL-C-39029/21 Skt
M22520/21-04	D12LS-1M	POSITIONER	5120-00-124-3422	MIL-C-39029/20 Skt
M22520/3-7	G259	GAGE (RETAINERS)	--	
M22520/22-01	MH804	TOOL FRAME	5120-00-124-3487	
M22520/22-02	D12/1-1M	POSITIONER	5120-01-335-8650	MIL-C-39029/19 Pin, /21 Skt
M22520/22-03	D12/2-1M	POSITIONER	5120-00-124-3458	MIL-C-39029/20 Skt
M22520/3-8	G260	GAGE (RETAINERS)		

Open Frame Crimp Tools

M22520/5-01 (HX4) M22520/10-01 (HX3)

The DMC HX4 and HX3 series crimp tools feature a system of interchangeable dies which eliminate the need for separate fixed die crimp tools for each and every different application. Many maintenance and production organizations have standardized on one of these models, thus eliminating the cost associated with maintaining and calibrating bulky inventories of single purpose, dedicated tools.

TYPICAL DIE SET

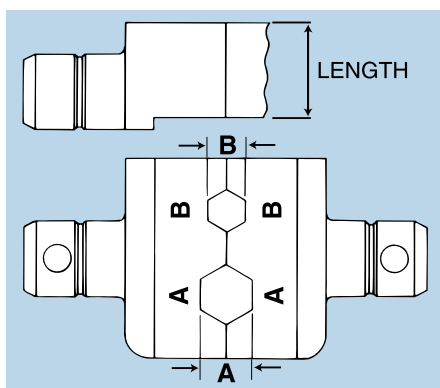

Tremendous flexibility and cost advantages exist with this crimping system due to the wide variety of military and proprietary interchangeable dies available for these tool frames. As new requirements evolve, a new set of dies is all that's required to meet the demand.

Crimping dies are snapped into the tool frame and retained in place by internal spring clips. They may be permanently secured, if desired, by pressing a roll pin into the holes provided.

The tool frames are equipped with a positive ratchet assembly which controls complete handle movement in both directions.

Hexagonal crimp dies are available in a variety of combinations having single, double, and even triple cavity design. These dies accommodate most coaxial and triaxial connectors and contacts conforming to MIL-DTL-39012, AS39029, and numerous proprietary configurations. Other designs are available for coaxial connections requiring different termination techniques.

Dies in various crimp patterns are also available for insulated and uninsulated terminal lugs, wire splices and end caps relating to M7928, MS17143, MS25036, MS25181, MS27429, MS25274, MS20659, M81824, MS21003 through MS21015, and commercial part numbers. Several power contacts too large for conventional hand tools are also covered by interchangeable dies for the standard tool frame (HX4).

If your application requirement is not already covered by one of our standard dies our engineering department will be pleased to discuss a design to suit your needs.

The HX4 is 11" in length and weighs approximately 21 oz. The HX3 is 9" in length and weighs 11 oz.

DMC169A (M83521/7-01) & DMC169 (M83507/9-01) TOOL KITS

The DMC169A and DMC169 tool kits consist of an HX4, Blade Micrometer, and 27 die sets. Each tool kit covers Mil-Spec shielding ferrules (MS21980/MS21981) and Mil-Spec coaxial contacts (M39029/6/13/14, M39029/7/8, M83733/13/14 and 0N089558).



Open Frame Crimp Tool Part Numbers

DIE P/N			DIE CLOSURE DIMENSIONS			
DMC P/N *	MILITARY P/N	NATIONAL STOCK NO. N.S.N.	A HEX.	LENGTH	B HEX.	LENGTH
HX4	M22520/5-01	5120-01-335-8575	Standard Crimp Tool Frame			
Y200P	M22520/5-02	5120-01-335-8244	.091	.090	.068	.270
Y196	M22520/5-03	5120-01-335-8245	.128	.325	.105	.325
Y152	M22520/5-04	5120-01-335-8246	.138	.090	.118	.270
Y197	M22520/5-05	5120-01-335-8247	.213	.325	.178	.325
Y203	M22520/5-06	5120-01-335-8248	.128	.094		
Y195	M22520/5-07	5120-01-335-8249	.255	.325		
Y215	M22520/5-08	5120-01-335-8250	.128	.375		
Y204P	M22520/5-09	5120-01-335-8251	.178	.400	.068	.093
Y189	M22520/5-10	5120-01-335-8252	.160	.400		
Y205P	M22520/5-11	5120-01-335-8253	.213	.400	.068	.093
Y206P	M22520/5-13	5120-00-133-0585	.255	.400	.068	.093
Y207P	M22520/5-15	5120-01-335-8255	.263	.400	.068	.093
Y193	M22520/5-17	5120-00-133-0597	.118	.375		
Y142	M22520/5-19	5120-01-335-8257	.255	.400	.213	.400
Y149	M22520/5-21	5120-01-335-8258	.475	.400		
Y145	M22520/5-23	5120-01-335-8259	.384	.400		
Y110P	M22520/5-25	5120-01-335-8260	.429	.400	.100	.120
Y151	M22520/5-27	5120-01-335-8261	.532	.400		
Y109P	M22520/5-29	5120-01-335-8262	.324	.400	.100	.120
Y150	M22520/5-31	5120-01-335-8263	.501	.400		
Y136	M22520/5-33	5120-01-335-8264	.343	.400	.105	.400
Y137	M22520/5-35	5120-01-335-8265	.324	.400	.128	.400
Y138	M22520/5-37	5120-01-335-8266	.314	.400	.151	.400
Y139	M22520/5-39	5120-01-335-8267	.309	.400	.160	.400
Y140	M22520/5-41	5120-01-335-8268	.290	.400	.178	.400
Y141	M22520/5-43	5120-01-335-8269	.268	.400	.197	.400
Y143	M22520/5-45	5120-01-335-8270	.231	.400	.218	.400
Y144	M22520/5-47	5120-01-335-8271	.359	.400		
Y146	M22520/5-49	5120-00-133-0644	.401	.400		
Y147	M22520/5-51	5120-00-116-3040	.431	.400		
Y148	M22520/5-53	5120-01-335-8294	.454	.400		
Y102	M22520/5-55	5120-01-335-8295	.324	.400		

DIE P/N			DIE CLOSURE DIMENSIONS			
DMC P/N *	MILITARY P/N	NATIONAL STOCK NO. N.S.N.	A HEX.	LENGTH	B HEX.	LENGTH
Y209P	M22520/5-57	5120-01-335-8296	.213	.400	.100	.120
Y208P	M22520/5-59	5120-01-335-8297	.255	.400	.100	.120
Y178	M22520/5-61	5120-01-335-8298	.429	.400		
Y314P	M22520/5-63	5120-01-335-8299	.263	.400	.091	.090
Y501	M22520/5-100	5120-00-126-0860	Pre-Insulated Terminal Crimp 26-10 AWG			
Y527	M22520/5-101	5120-01-335-8301	Pre-Insulated Splice Crimp 26-20 AWG			
Y539	M22520/5-102	5120-01-335-8302	Splice Crimp 12-1 6 AWG			
Y540	M22520/5-103	5120-01-335-8303	Splice Crimp 16-26 AWG			
Y631	M22520/5-105	5120-01-361-9554	.218	.307		
			Miniature Crimp Tool Frame			
HX3	M22520/10-01	5120-00-117-4830				
X115S	M22520/10-02	5120-01-335-8304	.091	.090	.068	.270
X103	M22520/10-03	5120-01-335-8305	.255	.325		
X123	M22520/10-04	5120-01-335-8277	.138	.090	.118	.270
X101	M22520/10-05	5120-01-335-8278	.128	.325	.105	.325
X125	M22520/10-06	5120-01-335-8279	.160	.400		
X102	M22520/10-07	5120-01-335-8280	.213	.325	.178	.325
X140	M22520/10-08	5120-01-335-8281	.128	.093		
X129	M22520/10-09	5120-01-335-8282	.118	.327		
X136	M22520/10-10	5120-01-335-8283	.128	.375		
X225	M22520/10-11	5120-01-335-8284	.105	.400		
X118	M22520/10-13	5120-01-335-8285	.128	.400		
X226	M22520/10-15	5120-01-335-8286	.151	.400		
X149	M22520/10-17	5120-01-335-8287	.178	.400		
X147	M22520/10-19	5120-01-335-8288	.197	.400		
X144	M22520/10-21	5120-01-335-8289	.213	.400		
X155	M22520/10-23	5120-01-335-8290	.218	.400		
X156	M22520/10-25		.231	.400		
X187	M22520/10-27	5120-01-335-8291	.255	.400		
X515	M22520/10-100	5120-00-116-3286	Terminal/Splice Crimp 12-10 AWG			
X511	M22520/10-101	5120-00-116-2992	Terminal/Splice Crimp 26-14 AWG			
X525	M22520/10-102	5120-01-335-8274	Terminal/Splice Crimp 26-20 AWG			
X527	M22520/10-103	5120-00-124-3734	Splice Crimp 16-12 AWG			
X528	M22520/10-104	5120-01-335-8276	Splice Crimp 26-16 AWG			

* Die part numbers ending in "P" indicate that the die set has an alignment guide pin.

Battery Powered Hydraulic Open Frame Crimp Tools

GET THE PORTABILITY OF A HAND TOOL WITH THE STAMINA OF A POWER TOOL!

DMC is pleased to present our battery powered hydraulic tools to crimp copper and aluminum cable #26 to #8 AWG with DMC "Y" Dies (M22520/5-XX and others). These tools are comparable to DMC's HX4 hand tool and use the same Y-dies.

Working on today's electrical systems calls for increased mobility and repeatable, consistent crimping force. To satisfy this need, DMC offers a battery powered hydraulic crimp tool designed to integrate your current tooling systems. The ergonomic tool body helps reduce workplace injuries and eases operator fatigue keeping costs low and production high.

DMC battery powered tools have been engineered to work with our existing Y-die series and compliment our established crimp tools. And, as always, if we don't have a die to meet your needs, we'll engineer and manufacture it for you.

ADJUSTABLE DIES FOR INSULATED TERMINALS & SPLICES

COLOR	SIZE	P/N
Yellow	12-10	Y670
Blue	16-14	Y671
Red	22-18	Y672
Yellow	26-24	Y678
Red/Blue	22-14	Y1060

Adjustable Crimping Dies accept terminations which conform to AS7928, AS25036 (class 1 and 2) and other military or commercial specifications.

HXE4B

The HXE4B Battery Powered Hydraulic Open Frame Crimp Tool is a hand held, self-contained crimp tool. The crimp head, battery, and pump unit are contained in one ergonomic tool body and weighs about 4 pounds. It is comparable to DMC's HX4 hand tool and uses the same Y-dies. (See page 71 & 77)

HXE4AB

This tool is available with an optional spring loaded push rod to hold the product in the crimping position (dies normally closed). (P/N HXE4AB)

HXE4B



FEATURES

- Ergonomic design allows one-handed operation
- Die automatically opens when crimp is complete
- Indicating complete crimp pressure cycle has been achieved
- Head rotates 350 degrees
- Red LED to display the charge status of the battery

CRIMP CAPACITIES

- #26 to #8 AWG (copper terminations)
- Max. Crimp Force: 1.5 Tons (13.3 kN)
- Avg. Crimp Time: 2 seconds
- Avg. Crimps per Charge: 200
- Charge Time: 15 mins (Avg.)

SPECIFICATIONS

- Length: 14.5" (368 mm)
- Width: 2.87" (72.9 mm)
- Depth: 4.5" (114.3 mm)
- Weight (with battery): 3.18 lb (1.4 kg)
- Sound Level: 75 db(A) at 1 meter
- Vibration: <8.2 ft/s² (2.5 m/s²)
- Hydraulic Oil: Shell Tellus® T-15

TOOL INCLUDES: Carrying Case, Gage, Die Removal Tool, Two 18v Batteries (p/n HDE-LI-B), One Battery Charger (p/n HDE-LI-120C).

Dies must be ordered separately.



HXE4-R

The HXE4-R Remote Head Battery Powered Hydraulic Open Frame Crimp Tool is a portable, self-contained crimp tool. The lightweight crimp head is connected to the battery and pump unit by a hydraulic umbilical cable. This reduces the held weight to 2 pounds, about the same as the manual tool. The battery and pump unit can be worn by the operator on a tool belt, stored in a carrying case, or mounted to a bench top. It is comparable to DMC's HX4 hand tool and uses the same Y-dies. (See page 71 & 77).

ADJUSTABLE DIES FOR INSULATED TERMINALS & SPLICES		
COLOR	SIZE	P/N
Yellow	12-10	Y670
Blue	16-14	Y671
Red	22-18	Y672
Yellow	26-24	Y678
Red/Blue	22-14	Y1060

Adjustable Crimping Dies accept terminations which conform to AS7928, AS25036 (class 1 and 2) and other military or commercial specifications.



FEATURES

- Ergonomic design allows one-handed operation
- Die automatically opens when crimp is complete
- Die can be pre-closed under spring pressure (thumb actuated release standard)
- Connection point for tool balancing systems

CRIMP CAPACITIES

- #26 to #8 AWG (copper terminations)
- Max Crimp Force: 3500lb/15.6kN Max
- Oil Pressure: 4000psi/276 bar Max
- Crimp Time: Approx. 3.5 seconds
- Crimps per Charge: Approx. 250

CRIMP TOOL

- Length: 9.5"/241mm
- Width: 2.5"/63.5mm
- Depth: 2.5"/63.5mm
- Weight: 1.64lb/.74kg
- Hose Length: 4.5ft (permanently attached)

POWER UNIT WITH BATTERY INSTALLED

- Length: 9.8"/248mm
- Width: 3.1"/80mm
- Depth: 5.6"/142mm
- Weight: 4.3lb/2.0kg
- Sound Level: 72dBA
- Hydraulic Oil: 1.7oz/48g Shell Tellus T-15
- Charging Voltage: 10.8 VDC Lithium Ion Type Battery
- Charging Time: Approx. 40 minutes (Avg.)

TOOL INCLUDES: Case, Gage, Die Removal Tool, Two Batteries (p/n HD-BATTERY-R), One Battery Charger (p/n HD-110CHARGER-R). Tool Belt, AC Adapter, and Bench Mount sold separately.

Dies must be ordered separately.



The battery and pump unit can be worn on a tool belt... (p/n 2063863-1)



used with an AC adapter... (p/n HD-110AC)



or mounted to a bench top. (p/n BM-7)

Pneumatic Open Frame Tool

HX23 BENCH CRIMP PRODUCTION PRESS

COMPATIBILITY WITH EXISTING CRIMP DIES

The HX23 accommodates most M22520/5-XX military and Daniels "Y" series crimp dies.

This affords utilization of existing dies and interchangeability with M22520/5-01 (Daniels HX4) hand tool frames.

FULL CYCLE CONTROL

Full die closure is assured on every crimp. The internal cycle control network will not allow the tool to open until complete closure is attained. A simple procedure is available to open the tool in cases where a complete cycle cannot be effected.

A secure method is provided to prevent unauthorized personnel from defeating the cycle control system.

HANDS FREE OPERATION

There are no awkward levers or mechanisms used to open or close the crimp dies. These operations waste time and distract the operator's attention.

When the tool is in the normal condition, the crimp dies are fully open where contact assemblies can easily be inserted. A touch of the foot valve releases the dies to a gripping position (spring pressure only). When the operator is satisfied that the contact assembly is positioned correctly and hands are in a safe position, another actuation of the same foot valve completes the crimp and quickly returns the die to the open position for removal of the crimped assembly and loading of the next parts.

MOUNTING

The HX23 is supplied with a stable bench mount with can remain unattached for portability. Or, can be mounted to a workstation by installing fasteners through the holes provided.

The HX23 Production Crimp Press can be used in horizontal or vertical positions.

SAFETY FEATURES:

- 2 Step Crimping Process
- Emergency Stop Switch



OPERATOR SAFETY FEATURES

The HX23 is equipped with a transparent guard which affords the protection, but does not restrict vision.

The Hands Free Operation system allows the operator to position the contact assembly while the die is under spring pressure only.

The operator is then free to let the tool hold the contact assembly during the crimp cycle while the operator's hands and fingers are a safe distance from the crimping die.

The HX23 foot valve assembly is constructed with a protective shroud to prevent accidental actuation. For operation the operator places their foot under the shroud to depress the pedal.

FULL PNEUMATIC OPERATION

Standard clean, dry shop air at the recommended pressure is all that is required to operate the HX23 tool. There are no electrical or hydraulic requirements.

ADJUSTABLE DIES FOR INSULATED TERMINALS & SPLICES

COLOR	SIZE	P/N
Blue	16-14	Y671
Red	22-18	Y672
Yellow	26-24	Y678
Red/Blue	22-14	Y1060

Adjustable Crimping Dies accept terminations which conform to AS7928, AS25036 (class 1 and 2) and other military or commercial specifications.

HX23 SPECIFICATIONS

COMPONENTS	SIZE	WEIGHT
TOOL FRAME	4 x 6 x 16 (in)	11 LBS
(LESS BENCH MOUNT)	11.4 x 15.2 x 40.6 (cm)	5.2 KG
FOOT VALVE	4 x 5 x 13 (in)	6 LBS
	10.2 x 12.7 x 34.3 (cm)	2.7 KG
HOSE ASSM. (BETWEEN FOOT PRESS AND CRIMP TOOL)	9 Feet – 2.7 Meters	N/A
AIR REQUIREMENTS		
80-95 PSI (5.4-6.4 BAR)		

X-Die Pneumatic Tool Bench Press Style Crimp Tool

PHX3 PNEUMATIC TOOL

COMPATIBILITY WITH EXISTING CRIMP DIES

The PHX3 accommodates all M22520/10-XX military and Daniels "X" series crimp dies. This affords total utilization of existing dies and total interchangeability with M22520/10-01 (Daniels HX3) hand tool frames.

FULL CYCLE CONTROL

Full die closure is assured on every crimp. The internal cycle control network will not allow the tool to open until complete closure is attained.

OPERATOR SAFETY FEATURES

The PHX3 is equipped with a crimp cavity guard to remind users to keep fingers clear of the crimp dies.

FULL PNEUMATIC OPERATION

Standard clean, dry shop air at the recommended pressure (100 - 120 psi) is all that is required to operate the PHX3 tool. There are no electrical or hydraulic requirements.



Safety Guard not shown.

A Bench Mount is Available (P/N BM-2A)

BENCH PRESS STYLE OPEN FRAME CRIMP TOOLS UDT4 & UDT3

The UDT4 & UDT3 tools have the die frame opening on the opposite side of the tool frame from the HX4 & HX3 so the tool can be used as a portable bench top press or as a hand tool. The tool frames are equipped with the same positive ratchet assembly and accept the same "Y" and "X" series dies. When used as a bench top press, the operator gains a greater mechanical advantage, thereby reducing operator fatigue.

Electric/Hydraulic Open Frame Crimp Tool

A TOTALLY SELF-CONTAINED PORTABLE CRIMP SYSTEM

The EHCY is a fast cycling bench-top crimp tool designed to be light-weight and rugged. The versatile features of the EHCY make this a good choice where production and quality cannot be compromised.

This unit is small in overall size (10.0" H x 7.1" W x 19.1" L) and weighs approximately 27 pounds, but has ample die force power to do most jobs. The crimp cycle time is only two seconds.

COMPATIBILITY WITH EXISTING CRIMP DIES

The EHCY accommodates all M22520/5-XX military and Daniels "Y" series crimp dies. This affords total utilization of existing dies and total interchangeability with M22520/5-01 (Daniels HX4) hand tool frames.

FULL CYCLE CONTROL

Full crimp pressure is assured on every crimp. The internal cycle control network will not allow the tool to open until complete pressure is attained. The cycle is disabled when the Emergency Stop button is actuated.

OPERATOR SAFETY FEATURES

The EHCY is equipped with a crimp cavity guard to remind users to keep fingers clear of the crimp dies.

An Emergency Stop button is located on top of the tool. Depressing this button releases the hydraulic pressure and retracts the crimp dies to re-open.

A Foot Pedal is Available (P/N EHCFP) When plugged to the crimp press, it disables the front panel actuator.



UNINSULATED TERMINALS MS20659				
AWG SIZE	DIE P/N	CRIMP HEIGHT	INDENT	GAGE
#8-RED	Y844HN	0.135"	SGL	G744
#8-RED	Y845HN	0.135"	DBL	G744
#6-BLUE	Y846HN	0.176"	SGL	G745
#6-BLUE	Y847HN	0.176"	DBL	G745

INSULATED TERMINALS MS25036			
AWG SIZE	DIE P/N	CRIMP HEIGHT	GAGE
#8-RED	Y673H	0.17"	G682
#6-BLUE	Y674H	0.202"	G683

HEX DIES			
AWG SIZE	DIE P/N	CRIMP HEIGHT	GAGE
0.202" Hex Crimp	Y870H	0.202"	G724

ADJUSTABLE DIES FOR INSULATED TERMINALS & SPLICES		
COLOR	SIZE	P/N
Yellow	12-10	Y670
Blue	16-14	Y671
Red	22-18	Y672
Yellow	26-24	Y678
Red/Blue	22-14	Y1060

Adjustable Crimping Dies accept terminations which conform to AS7928, AS25036 (class 1 and 2) and other military or commercial specifications.

- Standard model (P/N EHCY) operates on 110 VAC power (power cord included).
- Models available for other power and power cord requirements. Inquire with DMC for details.

DMC constantly adds new crimp die designs that are comparable to connector and terminal supplier dies or tools. A few of the popular “Y” die applications are featured in the following chart. For more options, consult factory.

TYPICAL DIE CONFIGURATIONS

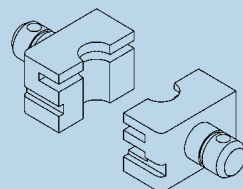
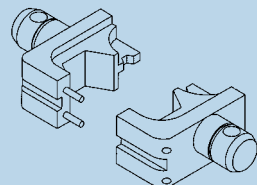
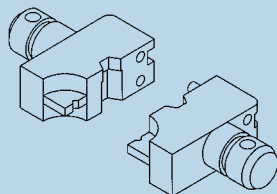
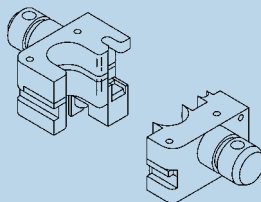
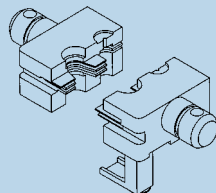
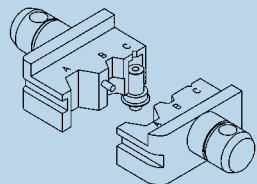

MFR. TOOL	DMC	MFR. TOOL	DMC	MFR. TOOL	DMC	MFR. TOOL	DMC
AMP 220009-1-B	Y827	AMPHENOL 227-1228	Y240S	CANNON APK 15 & 25	Y831	MS25312-2	Y509
AMP 220015-1	Y587	AMPHENOL 227-1242	Y323S	CANNON BUCH. 612992	Y331	MS25312-3	Y508
AMP 220045-2	Y588	AMPHENOL 227-125	Y129	CANNON CCT-406M	Y321	MS25312-4	Y507
AMP 220066-1	Y586	AMPHENOL 227-1350	Y324S	CANNON CCT-C1	Y316	MS27143	Y627
AMP 227-1400	Y800P	AMPHENOL 227-1351-1	Y325	CANNON CCT-C10	Y320	MS27144	Y627
AMP 277-980-3	Y773P	AMPHENOL 227-1351-2	Y344	CANNON CCT-C2	Y555	MS27148	Y627
AMP 45158-2	Y717	AMPHENOL 227-1351-3	Y326	CANNON CCT-C3	Y317	RADIALL R282 235 901	Y915
AMP 45238-2	Y721	AMPHENOL 227-1351-4	Y346	CANNON CCT-C5	Y318	RADIALL R282230	Y342
AMP 45239-2	Y720	AMPHENOL 227-1351-5	Y347	CANNON CCT-C6	Y319	RAYCHEM AD1377	Y516
AMP 45240-2	Y719	AMPHENOL 227-1351-6	Y348	CANNON CCT-C7A	Y557	T&B WT232	Y173
AMP 45241-2	Y718	AMPHENOL 227-1354	Y355S	CANNON CCT-C8	Y558	T&B RA18-188	Y580
AMP 46673	Y751	AMPHENOL 227-1355	Y356S	CANNON CCT-C9	Y559	T&B WT157N	Y689
AMP 46988	Y752	AMPHENOL 227-1358	Y357	CANNON CCT-CKM1	Y560	T&B WT200	Y119
AMP 49935	Y788	AMPHENOL 227-1392-03	Y488S	CANNON CCT-CX2	Y556	T&B WT200-06-08	Y360
AMP 501295-1	Y923	AMPHENOL 227-1395	Y654	CANNON CCT-DM	Y322	T&B WT200-06-11	Y443
AMP 52561	Y934A	AMPHENOL 227-1402	Y677	DEUTSCH 20055	Y380	T&B WT201-03-10	Y410
AMP 58237-1	Y902	AMPHENOL 227-1403	Y493	KINGS 683-514/0-3	Y397	T&B WT202-06-08	Y409
AMP 58237-2	Y897	AMPHENOL 227-1409	Y688PS	KINGS 683-51559	Y467	T&B WT202-06-08	Y411
AMP 58238-2-A	Y896	AMPHENOL 227-1414	Y780	KINGS KTH1002	Y464	T&B WT203	Y198
AMP 58249-1	Y692	AMPHENOL 227-200	Y133	KINGS KTH1061	Y575	T&B WT209, 409	Y211
AMP 583424	Y906	AMPHENOL 227-350	Y132	KINGS KTH1077	Y828P	T&B WT210, 410	Y212
AMP 583424-1,-2	Y904	AMPHENOL 227-375	Y131	KINGS KTH1078	Y609	T&B WT215	Y139
AMP 583424-5	Y903	AMPHENOL 227-400	Y130P	KINGS KTH1079	Y630P	T&B WT216	Y138
AMP 583424-6	Y905	AMPHENOL 227-425	Y134	KINGS KTH2002	Y269	T&B WT218	Y145
AMP 58423-1	Y810P	AMPHENOL 227-600	Y225	KINGS KTH2012	Y277	T&B WT226	Y169
AMP 58423-2	Y811P	AMPHENOL 227-911	Y442	KINGS KTH2021	Y339	T&B WT227	Y170
AMP 59215	Y619	AMPHENOL 227-911	Y623	KINGS KTH2024	Y423	T&B WT229	Y178P
AMP 59250	Y1060	AMPHENOL 227-980-1	Y685	KINGS KTH2042	Y209P	T&B WT230	Y179
AMP 59255	Y753	AMPHENOL 227-980-2	Y686	KINGS KTH2061	Y572	T&B WT231	Y180
AMP 59459	Y745	AMPHENOL 227-980-5	Y787P	KINGS KTH2062	K575	T&B WT233	Y242
AMP 59461	Y794	AMPHENOL 294-1832	Y200P	KINGS KTH2062	Y762P	T&B WT234	Y293
AMP 59493-1	Y843	AMPHENOL 294-532	Y200P	KINGS KTH2063	Y617	T&B WT235	Y246
AMP 59508	Y748	AMPHENOL 294GB-5031	Y731	KINGS KTH2064	Y574	T&B WT238	Y245
AMP 59962-1	Y1997	AMPHENOL 48-326	Y477	KINGS KTH2067	Y573	T&B WT311	Y243
AMP 69149-1	Y732	AMPHENOL 611X1151	Y336	KINGS KTH2067	Y760P	T&B WT400	Y203
AMP 69223-1	Y733	AMPHENOL 611X1275-1	Y564	KINGS KTH2081	Y613	T&B WT400	Y215
AMP 69224-1	Y734	AMPHENOL 790-5185	Y255S	KINGS KTH2082	Y600	T&B WT400-02-08	Y219
AMP 69266-1	Y735	AMPHENOL 790-5284	Y257	KINGS KTH2101	Y633	T&B WT401	Y201
AMP 69339	Y589	AMPHENOL 790-5285	Y254	KINGS KTH2103	Y680	T&B WT401, 406, 411	Y292
AMP 69352	Y749	AMPHENOL 790-5431	Y250	KINGS KTH2105	Y634	T&B WT402	Y214
AMP 69355	Y750	ASTRO. 613876	Y328	KINGS KTH2127	Y635	T&B WT406	Y216
AMP 69363	Y590	ASTRO. 615550	Y330	KINGS KTH2128	Y636	T&B WT406M	Y321
AMP 69365-3	Y950	BENDIX 21-33145-1	Y690	KINGS KTH2140	Y837P	T&B WT411	Y190
AMP 69408	Y736	BURNDY MR8PV-2	Y530	KINGS KTH2162	Y679	T&B WT414	Y191
AMP 69422	Y737	BURNDY MR8-PVS	Y524	KINGS KTH2168	Y932	T&B WT419	Y192
AMP 69423	Y738	BURNDY N14HET-25	Y881	KINGS KTH2175	Y940	TROMPETER CD5-10	Y776
AMP 69424	Y739	BURNDY N14RT-10	Y818	KINGS KTH2177	Y825	TROMPETER CD5-11	Y777
AMP 69425	Y740	BURNDY N22RVMT-10	Y512	KINGS KTH2180	Y829P	TROMPETER CD5-8	Y778
AMP 69429	Y741	BURNDY N22RVMT-15	Y817	KINGS KTH2207	Y888	TROMPETER CD5-12	Y789F
AMP 69471	Y742	BURNDY YAV9C-L36	Y948	KINGS KTH2211	Y889	TROMPETER CD5-13	Y803
AMP 69477-4	Y938	CANNON 249-1400-000	Y249P	KINGS KTH2212	Y890	TROMPETER CD5-4	Y631
AMP 69493	Y743	CANNON 304-0445-000	Y894	KINGS KTH2213	Y910	TROMPETER CD5-7	Y775
AMP 69493-1	Y744	CANNON 317-1795-000	Y694	KINGS KTH2214	Y892	TROMPETER CD5-9	Y687
AMP 69646	Y746	CANNON 317-2071-000	Y824	KINGS KTH2216	Y893	TYCO 59250	Y1060
AMP 69646	Y537	CANNON 317-7178-000	Y830	KINGS KTH2229	Y911	TYCO 59275	Y1061
AMP 69726	Y1998	CANNON 990-001-391/392	Y358	M22520/5-104	Y692	TYCO AD1377	Y516
AMP 69811	Y747	CANNON 995-0001-761	Y704	MAC PANEL 452303	Y430-MP	WALTER KIDDE M616229	Y412
AMP 85-35181-SK11	Y692	CANNON 995-0002-113	Y702	MOLEX 8657-5001/2	Y922		
AMP 9036402A	Y929	CANNON 995-0002-143	Y708	MOLEX 86760-5003	Y926		
AMPHENOL 227-1221-6001	Y951	CANNON 995-0002-228	Y793	MS25312-1	Y510		

Others Available. Consult DMC.

Coaxial/Shielded Contact Tool Selection Guide

SHIELDED CONTACTS AND CONNECTOR SERIES	BIN CODE	CONTACT CAVITY SIZE	INNER CONTACT		SHIELD CRIMP SLEEVE		OUTER CONTACT		INSTALLING TOOL	REMOVAL TOOL
			CRIMPING TOOL	POSITIONER	CRIMPING TOOL	POSITIONER OR DIE	CRIMPING TOOL	POSITIONER OR DIE		
M39029/6-PIN CONTACT MIL-C-81511 SERIES 1 AND 2	120	16	AFM8	K262-1	HX4	Y200	HX4	Y200	DAK126-16A	DRK125-16A
	121	12	AFM8	K261-1	HX4	Y152	HX4 HX3	Y152 X123	DAK126-12A	DRK125-12A
	122	12	AFM8	K261-1	HX4	Y152	HX4 HX3	Y152 X123	DAK126-12A	DRK125-12A
	123	12	AFM8	K261-1	HX4 HX3	Y152 X123	HX4 HX3	Y152 X123	DAK126-12A	DRK125-12A
	124	12	AFM8	K261-1	HX4 HX3	Y152 X123	HX4 HX3	Y152 X123	DAK126-12A	DRK125-12A
	125	12	AFM8	K261-1	HX4	Y152	HX4 HX3	Y152 X123	DAK126-12A	DRK125-12A
	M39029/7-PIN CONTACT MIL-DTL-26482 SERIES 2 MIL-DTL-81703 SERIES 3	126	12	AFM8	K269-1	HX4	Y203			DAK83-12B
127		12	AFM8	K269-1	HX4	Y203			DAK83-12B	DRK83-12B
128		12	AFM8	K269-1	HX4	Y203			DAK83-12B	DRK83-12B
M39029/8-SKT CONTACT MIL-DTL-26482 SERIES 2 MIL-DTL-81703 SERIES 3	129	12	AFM8	K269-1	HX4	Y203			DAK83-12B	DRK83-12B
	130	12	AFM8	K269-1	HX4	Y203			DAK83-12B	DRK83-12B
	131	12	AFM8	K269-1	HX4	Y203			DAK83-12B	DRK83-12B
M39029/13-SKT CONTACT MIL-C-81511 SERIES 1	152	16	AFM8	K262-1	HX4	Y200	HX4 HX4	Y200 Y152	DAK126-16A	DRK129-16A
	153	12	AFM8	K261-1	HX4	Y152	HX3 HX4	X123 Y152	DAK126-12A	DRK129-12A
	154	12	AFM8	K261-1	HX4	Y152	HX3 HX4	X123 Y152	DAK126-12A	DRK129-12A
	155	12	AFM8	K261-1	HX4 HX3	Y152 X123	HX4 HX3	Y152 X123	DAK126-12A	DRK129-12A
	156	12	AFM8	K261-1	HX4 HX3	Y152 X123	HX4 HX3	Y152 X123	DAK126-12A	DRK129-12A
	157	12	AFM8	K261-1	HX4	Y152	HX4 HX3	Y152 X123	DAK126-12A	DRK129-12A
M39029/14-SKT CONTACT MIL-C-81511 SERIES 2	158	16	AFM8	K262-1	HX4	Y200	HX4	Y200	DAK126-16A	DRK129-16A
	159	12	AFM8	K261-1	HX4	Y152	HX4 HX3	Y152 X123	DAK126-12A	DRK129-12A
	160	12	AFM8	K261-1	HX4	Y152	HX4 HX3	Y152 X123	DAK126-12A	DRK129-12A
	161	12	AFM8	K261-1	HX4 HX3	Y152 X123	HX4 HX3	Y152 X123	DAK126-12A	DRK129-12A
	162	12	AFM8	K261-1	HX4 HX3	Y152 X123	HX4 HX3	Y152 X123	DAK126-12A	DRK129-12A
	163	12	AFM8	K261-1	HX4	Y152	HX4 HX3	Y152 X123	DAK126-12A	DRK129-12A
M39029/19-PIN CONTACT MIL-C-81511 SERIES 3 AND 4	181	16	AFM8	K373-1	MH802	D16/1-1M	MH801	D16P-1M	MS3160-16	MS3160-16
			AFM8	K373-1	MH802	D16/1-1M	MH801	D16P-1M		
	182	12	AFM8	K372-1	MH804	D12/1-1M	MH803	D12P-1M	MS3160-12	MS3160-12
			AFM8	K372-1	MH804	D12/1-1M	MH803	D12P-1M		
	183	12	AFM8	K372-1	MH804	D12/1-1M	MH803	D12P-1M	MS3160-12	MS3160-12
			AFM8	K372-1	MH804	D12/1-1M	MH803	D12P-1M		
M39029/20-SKT CONTACT MIL-C-81511 SERIES 3	184	16	AFM8	K373-1	MH802	D16/2-1M	MH801	D16LS-1M	MS3160-16	MS3160-16
			AFM8	K373-1	MH802	D16/2-1M	MH801	D16LS-1M		
	185	12	AFM8	K372-1	MH804	D12/2-1M	MH803	D12LS-1M	MS3160-12	MS3160-12
			AFM8	K372-1	MH804	D12/2-1M	MH803	D12LS-1M		
	186	12	AFM8	K372-1	MH804	D12/2-1M	MH803	D12LS-1M	MS3160-12	MS3160-12
			AFM8	K372-1	MH804	D12/2-1M	MH803	D12LS-1M		
M39029/21-SKT CONTACT MIL-C-81511 SERIES 4	187	16	AFM8	K373-1	MH802	D16/2-1M	MH801	D16S-1M	MS3160-16	MS3160-16
			AFM8	K373-1	MH802	D16/2-1M	MH801	D16S-1M		
	188	12	AFM8	K372-1	MH804	D12/1-1M	MH803	D12S-1M	MS3160-12	MS3160-12
			AFM8	K372-1	MH804	D12/1-1M	MH803	D12S-1M		
	189	12	AFM8	K372-1	MH804	D12/1-1M	MH803	D12S-1M	MS3160-12	MS3160-12
			AFM8	K372-1	MH804	D12/1-1M	MH803	D12S-1M		
			AFM8	K372-1	MH804	D12/1-1M	MH803	D12S-1M		

Coaxial/Shielded Contact Tool Selection Guide

SHIELDED CONTACTS AND CONNECTOR SERIES	BIN CODE	CONTACT CAVITY SIZE	INNER CONTACT		SHIELD CRIMP SLEEVE		OUTER CONTACT		INSTALLING TOOL	REMOVAL TOOL
			CRIMPING TOOL	POSITIONER	CRIMPING TOOL	POSITIONER OR DIE (CAVITY)	CRIMPING TOOL	POSITIONER OR DIE (CAVITY)		
M39029/25-PIN CONTACT MIL-DTL-26482 SERIES 1	204	12	AFM8	K496	HX4	Y189			DAK12B	DRK12B
	205	12	AFM8	K496						
	206	12	AFM8	K496	HX4	Y189				
M39029/26-SKT CONTACT MIL-DTL-26482 SERIES 1	207	12	AFM8	K496	HX4	Y189			DAK12B	DRK12B
	208	12	AFM8	K496						
	209	12	AFM8	K496	HX4	Y189				
M39029/27-SKT CONTACT MIL-PRF-38999 SERIES 2	210	12	AFM8	K323			GS200-1	G2P330	DAK95-12B	DRK95-12B
	402									
	403									
	404									
	405									
	406									
	407									
408										
M39029/28-PIN CONTACT MIL-PRF-38999 SERIES 1, 2, 3 & 4	211	12	AFM8	K323			GS200-1	G2P330	DAK95-12B	DRK95-12B
	409									
	410									
	411									
	412									
	413									
	414									
415										
M39029/50-PIN CONTACT MIL-DTL-83733	340	12	AFM8	K404			HX4	Y215	DAK83-12B	DRK83-12B
							HX3	X101		
M39029/51-SKT CONTACT MIL-DTL-83733	341	12	AFM8	K404			HX4	Y215	DAK83-12B	DRK83-12B
							HX3	X101		
M39029/54-PIN CONTACT MIL-DTL-26500	342	12	AFM8	K74S			HX4	Y215	DAK12B	DRK12B
							HX3	X101		
	343	8	AFM8	K75S-1			HX4	Y215	DAK55-8B	DRK56-8B
M39029/55-SKT CONTACT MIL-DTL-26500	344	12	AFM8	K74S			HX4	Y215	DAK12B	DRK12B
							HX3	X101		
	345	8	AFM8	K75S-1			HX4	X215	DAK55-8B	DRK56-8B
M39029/59-SKT CONTACT MIL-PRF-38999 SERIES 1, 3 & 4	366	8	AFM8	K406			HX4	Y197	BY HAND	DRK95-8B
							HX3	H102		
M39029/60-PIN CONTACT MIL-PRF-38999 SERIES 1, 3 & 4	367	8	AFM8	KY06			HX4	X197	BY HAND	DRK95-8B
							HX3	X102		
M39029/75-SKT CONTACT MIL-PRF-38999 SERIES 1, 3 & 4	416	12	AFM8	K323			GS200-1	G2P330	DAK95-12B	DRK95-12B
	417									
	418									
	419									
	420									
	421									
	422									
423										
M39029/76-PIN CONTACT MIL-PRF-38999 SERIES 1, 2, 3 & 4	424	16	AFM8	K532-1			GS100-1	GP295	DAK95-16B	DRK95-16B
	425									
	426									
	427									
M39029/77-SKT CONTACT MIL-PRF-38999 SERIES 1, 3 & 4	428	16	AFM8	K532-1			GS100-1	GP295	DAK95-16B	DRK95-16B
	429									
	430									
	431									
M39029/78-SKT CONTACT MIL-PRF-38999 SERIES 2 MIL-DTL-24308	432	16	AFM8	K532-1			GS100-1	GP295	DAK95-16B	DRK95-16B
	433									
	434									
	435									

R.F. Connectors Tool Selection Guide

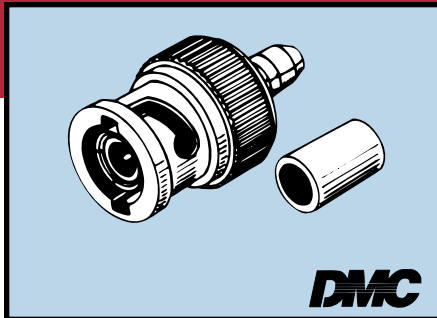

MIL-PRF-39012/16 SERIES BNC

CONNECTOR TYPE	CONNECTOR MILITARY PART NO.
PLUG PIN CONTACT	M39012/16-0501
	M39012/16-0502
	M39012/16-0503
	M39012/16-0504

CONTACT GUIDE				APPLICABLE CABLE RG-/U	CRIMP TOOL		POSITIONER OR DIE	
CONTACT MILITARY PART NO.*	PIN OR SKT	COLORBAND						
		□	○					
I.C. M39012/16-12	P	ORA	YEL	122	AF8		TH270	
O.F. M39012/16-50	—	—	—		HX4	HX3	Y197	X102
I.C. M39012/16-11	P	BLU	YEL	180	AF8		TH270	
O.F. M39012/16-50	—	—	—		HX4	HX3	Y197	X102
I.C. M39012/16-10	P	RED	YEL	142	AF8		TH270	
O.F. M39012/16-51	—	—	—		HX4	HX3	Y197	X102
I.C. M39012/16-10	P	RED	YEL	58	AF8		TH270	
O.F. M39012/16-52	—	—	—		HX4	HX3	Y197	X102

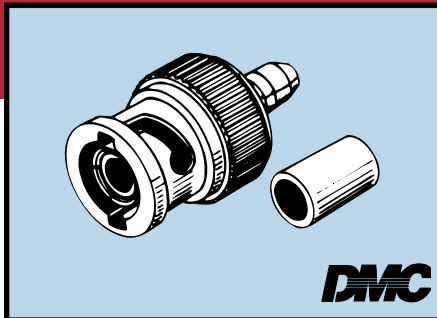

MIL-PRF-39012/17 SERIES BNC

CONNECTOR TYPE	CONNECTOR MILITARY PART NO.
PLUG SOCKET CONTACT	M39012/17-0501
	M39012/17-0502
	M39012/17-0503
	M39012/17-0504

CONTACT GUIDE				APPLICABLE CABLE RG-/U	CRIMP TOOL		POSITIONER OR DIE	
CONTACT MILITARY PART NO.*	PIN OR SKT	COLORBAND						
		□	○					
I.C. M39012/17-12	S	ORA	GRE	122	AF8		TH270	
O.F. M39012/17-50	—	—	—		HX4	HX3	Y197	X102
I.C. M39012/17-11	S	BLU	GRE	180	AF8		TH270	
O.F. M39012/17-50	—	—	—		HX4	HX3	Y197	X102
I.C. M39012/17-10	S	RED	GRE	142	AF8		TH270	
O.F. M39012/17-51	—	—	—		HX4	HX3	Y197	X102
I.C. M39012/17-10	S	RED	GRE	58	AF8		TH270	
O.F. M39012/17-52	—	—	—		HX4	HX3	Y197	X102

* I.C. - Inner Contact, O.F. - Outer Ferrule

R.F. Connectors Tool Selection Guide

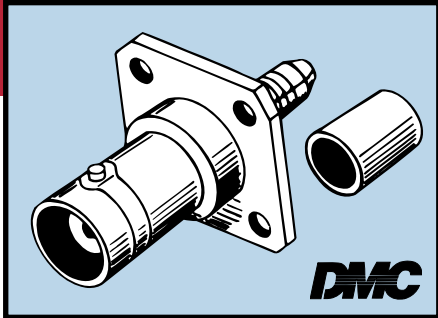

MIL-PRF-39012/18 SERIES BNC

CONNECTOR TYPE	CONNECTOR MILITARY PART NO.
RECEPTACLE, FLANGE MOUNTED	M39012/18-0501
	M39012/18-0502
	M39012/18-0503
	M39012/18-0504

CONTACT GUIDE				APPLICABLE CABLE RG-/U	CRIMP TOOL		POSITIONER OR DIE	
CONTACT MILITARY PART NO.*	PIN OR SKT	COLORBAND						
		□	○					
I.C. M39012/18-12 O.F. M39012/18-50	S —	ORA —	GRE —	122	AF8		TH270	
					HX4	HX3	Y197	X102
I.C. M39012/18-11 O.F. M39012/18-50	S —	BLU —	GRE —	180	AF8		TH270	
					HX4	HX3	Y197	X102
I.C. M39012/18-10 O.F. M39012/18-51	S —	RED —	GRE —	142 400	AF8		TH270	
					HX4	HX3	Y197	X102
I.C. M39012/18-10 O.F. M39012/18-52	S —	RED —	GRE —	58	AF8		TH270	
					HX4	HX3	Y197	X102

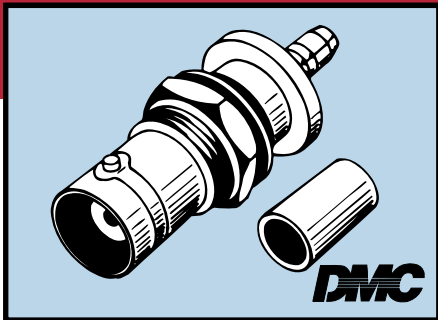

MIL-PRF-39012/19 SERIES BNC

CONNECTOR TYPE	CONNECTOR MILITARY PART NO.
JAM NUT MOUNT	M39012/19-0501
	M39012/19-0502
	M39012/19-0503
	M39012/19-0504

CONTACT GUIDE				APPLICABLE CABLE RG-/U	CRIMP TOOL		POSITIONER OR DIE	
CONTACT MILITARY PART NO.*	PIN OR SKT	COLORBAND						
		□	○					
I.C. M39012/19-12 O.F. M39012/19-50	S —	ORA —	BLU —	122	AF8		TH270	
					HX4	HX3	Y197	X102
I.C. M39012/19-11 O.F. M39012/19-50	S —	BLU —	BLU —	180	AF8		TH270	
					HX4	HX3	Y197	X102
I.C. M39012/19-10 O.F. M39012/19-51	S —	RED —	BLU —	142 400	AF8		TH270	
					HX4	HX3	Y197	X102
I.C. M39012/19-10 O.F. M39012/19-52	S —	RED —	BLU —	58	AF8		TH270	
					HX4	HX3	Y197	X102

* I.C. - Inner Contact, O.F. - Outer Ferrule

R.F. Connectors Tool Selection Guide

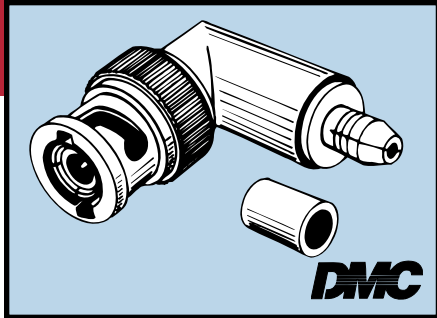

MIL-PRF-39012/20 SERIES BNC

CONNECTOR TYPE	CONNECTOR MILITARY PART NO.
PLUG RIGHT ANGLE	M39012/20-0501
	M39012/20-0502
	M39012/20-0503
	M39012/20-0504

CONTACT GUIDE				APPLICABLE CABLE RG-/U	CRIMP TOOL		POSITIONER OR DIE	
CONTACT MILITARY PART NO.*	PIN OR SKT	COLORBAND						
		□	○					
I.C. M39012/20-12 O.F. M39012/20-50	P —	ORA —	VIO —	122	AF8		TH270	
					HX4	HX3	Y197	X102
I.C. M39012/20-11 O.F. M39012/20-50	P —	BLU —	VIO —	180	AF8		TH270	
					HX4	HX3	Y197	X102
I.C. M39012/20-10 O.F. M39012/20-51	P —	RED —	VIO —	142 400	AF8		TH270	
					HX4	HX3	Y197	X102
I.C. M39012/20-10 O.F. M39012/20-52	P —	RED —	VIO —	58	AF8		TH270	
					HX4	HX3	Y197	X102

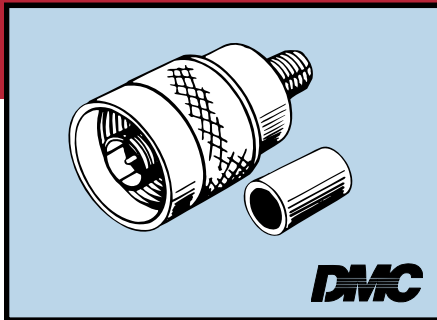

MIL-PRF-39012/1 SERIES N

CONNECTOR TYPE	CONNECTOR MILITARY PART NO.
PLUG	M39012/01-0501
	M39012/01-0502
	M39012/01-0503

CONTACT GUIDE				APPLICABLE CABLE RG-/U	CRIMP TOOL		POSITIONER OR DIE	
CONTACT MILITARY PART NO.*	PIN OR SKT	COLORBAND						
		□	○					
I.C. M39012/1-10 O.F. M39012/1-50	P —	RED —	BLA —	214 225 393	AF8		TH285	
					HX4		Y178	
I.C. M39012/1-10 O.F. M39012/1-51	P —	RED —	BLA —		213	AF8		TH285
				HX4			Y178	
I.C. M39012/1-11 O.F. M39012/1-52	P —	BLU —	BLA —	142 400	AF8		TH285	
					HX4	HX3	Y142	X144

* I.C. - Inner Contact, O.F. - Outer Ferrule

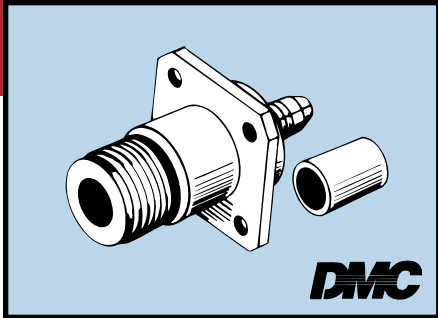

MIL-PRF-39012/2 SERIES N

CONNECTOR TYPE	CONNECTOR MILITARY PART NO.
PLUG AND RECEPTACLE FLANGE MOUNTED	M39012/02-0501
	M39012/02-0511
	M39012/02-0502
	M39012/02-0512
	M39012/02-0503
	M39012/02-0513

CONTACT GUIDE				APPLICABLE CABLE RG-/U	CRIMP TOOL		POSITIONER OR DIE	
CONTACT MILITARY PART NO.*	PIN OR SKT	COLORBAND						
		□	○					
I.C. M39012/2-10 O.F. M39012/2-50	S	RED	BRO	214	AF8		TH285	
	—	—	—	225	HX4	Y178		
	—	—	—	393				
I.C. M39012/2-10 O.F. M39012/2-51	S	RED	BRO	213	AF8		TH285	
	—	—	—		HX4	Y178		
I.C. M39012/2-11 O.F. M39012/2-52	S	BLU	BRO	142	AF8		TH285	
	—	—	—	400	HX4	HX3	Y142	X144

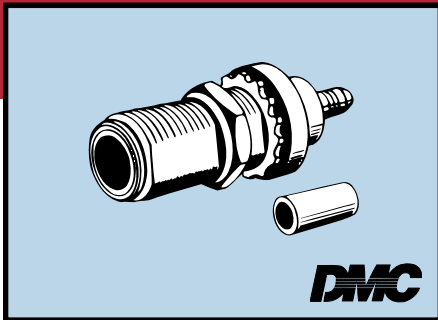

MIL-PRF-39012/3 SERIES N

CONNECTOR TYPE	CONNECTOR MILITARY PART NO.
JAM NUT MOUNTED	M39012/03-0501
	M39012/03-0502
	M39012/03-0503

CONTACT GUIDE				APPLICABLE CABLE RG-/U	CRIMP TOOL		POSITIONER OR DIE	
CONTACT MILITARY PART NO.*	PIN OR SKT	COLORBAND						
		□	○					
I.C. M39012/3-10 O.F. M39012/3-50	S	RED	RED	214	AF8		TH286	
	—	—	—	225	HX4	Y178		
	—	—	—	393				
I.C. M39012/3-10 O.F. M39012/3-51	S	RED	RED	213	AF8		TH286	
	—	—	—		HX4	Y178		
I.C. M39012/3-11 O.F. M39012/3-52	S	BLU	RED	142	AF8		TH286	
	—	—	—	400	HX4	HX3	Y142	X144

* I.C. - Inner Contact, O.F. - Outer Ferrule

R.F. Connectors Tool Selection Guide

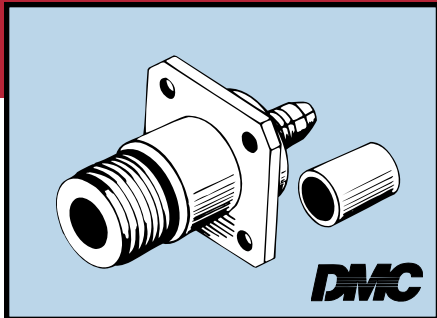

MIL-PRF-39012/5 SERIES N

CONNECTOR TYPE	CONNECTOR MILITARY PART NO.
PLUG RIGHT ANGLE	M39012/05-0501
	M39012/05-0502
	M39012/05-0503

CONTACT MILITARY PART NO.*	PIN OR SKT	COLORBAND		APPLICABLE CABLE RG-/U	CRIMP TOOL		POSITIONER OR DIE	
		□	○					
I.C. M39012/5-10 O.F. M39012/5-50	P —	RED —	ORA —	214 225 393	AF8 HX4		TH285 Y178	
I.C. M39012/5-10 O.F. M39012/5-51	P —	RED —	ORA —	213	AF8 HX4		TH285 Y178	
I.C. M39012/5-11 O.F. M39012/5-52	P —	BLU —	ORA —	142 400	AF8 HX4 HX3		TH285 Y142 X144	

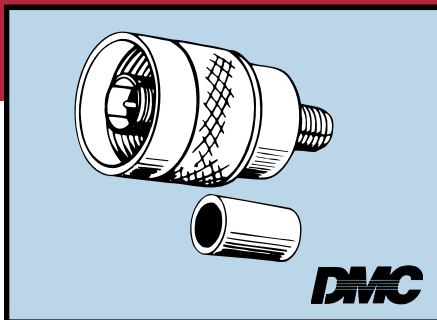

MIL-PRF-39012/26 SERIES TNC

CONNECTOR TYPE	CONNECTOR MILITARY PART NO.
PLUG PIN CONTACT	M39012/26-0501
	M39012/26-0502
	M39012/26-0503
	M39012/26-0504

CONTACT MILITARY PART NO.*	PIN OR SKT	COLORBAND		APPLICABLE CABLE RG-/U	CRIMP TOOL		POSITIONER OR DIE	
		□	○					
I.C. M39012/20-12 O.F. M39012/26-50	P —	ORA —	YEL —	122	AF8 HX4 HX3		TH270 Y197 X102	
I.C. M39012/26-11 O.F. M39012/26-50	P —	BLU —	YEL —	180	AF8 HX4 HX3		TH270 Y197 X102	
I.C. M39012/26-10 O.F. M39012/26-51	P —	RED —	YEL —	142 400	AF8 HX4 HX3		TH270 Y197 X102	
I.C. M39012/26-10 O.F. M39012/26-52	P —	RED —	YEL —	58	AF8 HX4 HX3		TH270 Y197 X102	

* I.C. - Inner Contact, O.F. - Outer Ferrule

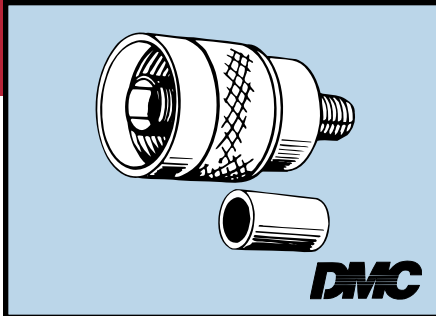

MIL-PRF-39012/27 SERIES TNC

CONNECTOR TYPE	CONNECTOR MILITARY PART NO.
PLUG SOCKET CONTACT	M39012/27-0501
	M39012/27-0502
	M39012/27-0503
	M39012/27-0504

CONTACT GUIDE				APPLICABLE CABLE RG-/U	CRIMP TOOL		POSITIONER OR DIE	
CONTACT MILITARY PART NO.*	PIN OR SKT	COLORBAND						
		□	○					
I.C. M39012/27-12 O.F. M39012/27-50	S —	ORA —	GRE —	122	AF8		TH270	
					HX4	HX3	Y197	X102
I.C. M39012/27-11 O.F. M39012/27-50	S —	BLU —	GRE —	180	AF8		TH270	
					HX4	HX3	Y197	X102
I.C. M39012/27-10 O.F. M39012/27-51	S —	RED —	GRE —	142 400	AF8		TH270	
					HX4	HX3	Y197	X102
I.C. M39012/27-10 O.F. M39012/27-52	S —	RED —	GRE —	58	AF8		TH270	
					HX4	HX3	Y197	X102

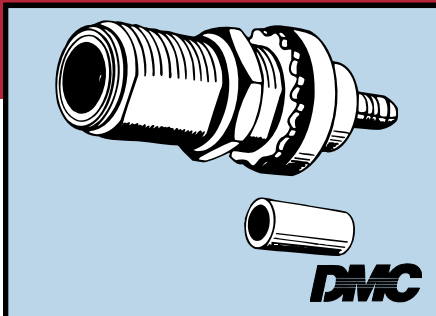

MIL-PRF-39012/28 SERIES TNC

CONNECTOR TYPE	CONNECTOR MILITARY PART NO.
JAM NUT MOUNT	M39012/28-0501
	M39012/28-0502
	M39012/28-0503
	M39012/28-0504

CONTACT GUIDE				APPLICABLE CABLE RG-/U	CRIMP TOOL		POSITIONER OR DIE	
CONTACT MILITARY PART NO.*	PIN OR SKT	COLORBAND						
		□	○					
I.C. M39012/28-12 O.F. M39012/28-50	S —	ORA —	BLU —	122	AF8		TH270	
					HX4	HX3	Y197	X102
I.C. M39012/28-11 O.F. M39012/28-50	S —	BLU —	BLU —	180	AF8		TH270	
					HX4	HX3	Y197	X102
I.C. M39012/28-10 O.F. M39012/28-51	S —	RED —	BLU —	142 400	AF8		TH270	
					HX4	HX3	Y197	X102
I.C. M39012/28-10 O.F. M39012/28-52	S —	RED —	BLU —	58	AF8		TH270	
					HX4	HX3	Y197	X102

* I.C. - Inner Contact, O.F. - Outer Ferrule

R.F. Connectors Tool Selection Guide

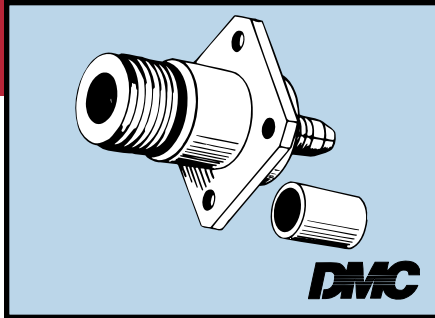

MIL-PRF-39012/29 SERIES TNC

CONNECTOR TYPE	CONNECTOR MILITARY PART NO.
RECEPTACLE FLANGE MOUNTING	M39012/29-0501
	M39012/29-0502
	M39012/29-0503
	M39012/29-0504

CONTACT GUIDE				APPLICABLE CABLE RG-/U	CRIMP TOOL		POSITIONER OR DIE	
CONTACT MILITARY PART NO.*	PIN OR SKT	COLORBAND						
		□	○					
I.C. M39012/29-12 O.F. M39012/29-50	S —	ORA —	GRE —	122	AF8		TH270	
					HX4	HX3	Y197	X102
I.C. M39012/29-11 O.F. M39012/29-50	S —	BLU —	GRE —	180	AF8		TH270	
					HX4	HX3	Y197	X102
I.C. M39012/29-10 O.F. M39012/29-51	S —	RED —	GRE —	142 400	AF8		TH270	
					HX4	HX3	Y197	X102
I.C. M39012/29-10 O.F. M39012/29-52	S —	RED —	GRE —	58	AF8		TH270	
					HX4	HX3	Y197	X102

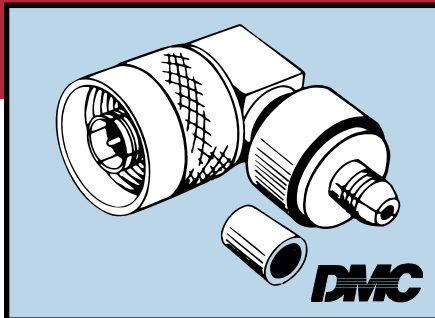

MIL-PRF-39012/30 SERIES TNC

CONNECTOR TYPE	CONNECTOR MILITARY PART NO.
PLUG RIGHT ANGLE	M39012/30-0501
	M39012/30-0502
	M39012/30-0503
	M39012/30-0504

CONTACT GUIDE				APPLICABLE CABLE RG-/U	CRIMP TOOL		POSITIONER OR DIE	
CONTACT MILITARY PART NO.*	PIN OR SKT	COLORBAND						
		□	○					
I.C. M39012/30-12 O.F. M39012/30-50	P —	ORA —	VIO —	122	AF8		TH270	
					HX4	HX3	Y197	X102
I.C. M39012/30-11 O.F. M39012/30-50	P —	BLU —	VIO —	180	AF8		TH270	
					HX4	HX3	Y197	X102
I.C. M39012/30-10 O.F. M39012/30-51	P —	RED —	VIO —	142 400	AF8		TH270	
					HX4	HX3	Y197	X102
I.C. M39012/30-10 O.F. M39012/30-52	P —	RED —	VIO —	58	AF8		TH270	
					HX4	HX3	Y197	X102

* I.C. - Inner Contact, O.F. - Outer Ferrule

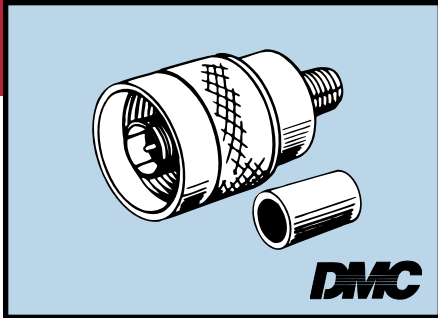

MIL-PRF-39012/35 SERIES SC

CONNECTOR TYPE	CONNECTOR MILITARY PART NO.
PLUG PIN CONTACT	M39012/35-0501
	M39012/35-0502
	M39012/35-0503

CONTACT GUIDE				APPLICABLE CABLE RG-/U	CRIMP TOOL		POSITIONER OR DIE	
CONTACT MILITARY PART NO.*	PIN OR SKT	COLORBAND						
		□	○					
I.C. M39012/35-10 O.F. M39012/35-50	P —	RED —	GRA —	214 225 393	AF8 HX4		TH286 Y178	
I.C. M39012/35-10 O.F. M39012/35-51	P —	RED —	GRA —	213	AF8 HX4		TH286 Y178	
I.C. M39012/35-11 O.F. M39012/35-52	P —	BLU —	GRA —	142 400	AF8 HX4 HX3		TH286 Y142 X144	

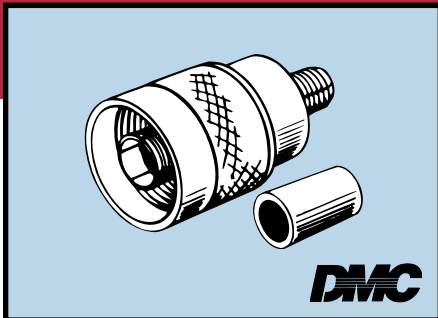

MIL-PRF-39012/36 SERIES SC

CONNECTOR TYPE	CONNECTOR MILITARY PART NO.
PLUG SOCKET CONTACT	M39012/36-0501
	M39012/36-0502
	M39012/36-0503

CONTACT GUIDE				APPLICABLE CABLE RG-/U	CRIMP TOOL		POSITIONER OR DIE	
CONTACT MILITARY PART NO.*	PIN OR SKT	COLORBAND						
		□	○					
I.C. M39012/36-10 O.F. M39012/36-50	S —	RED —	WHI —	214 225 393	AF8 HX4		TH286 Y178	
I.C. M39012/36-10 O.F. M39012/36-51	S —	RED —	WHI —	213	AF8 HX4		TH286 Y178	
I.C. M39012/36-11 O.F. M39012/36-52	S —	BLU —	WHI —	142 400	AF8 HX4 HX3		TH286 Y142 X144	

* I.C. - Inner Contact, O.F. - Outer Ferrule

R.F. Connectors Tool Selection Guide

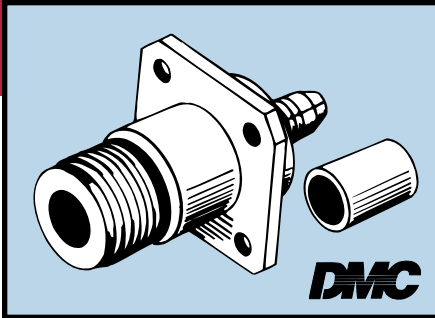

MIL-PRF-39012/38 SERIES SC

CONNECTOR TYPE	CONNECTOR MILITARY PART NO.
RECEPTACLE FLANGE MOUNTED	M39012/38-0501
	M39012/38-0502
	M39012/38-0503

CONTACT GUIDE				APPLICABLE CABLE RG-/U	CRIMP TOOL		POSITIONER OR DIE	
CONTACT MILITARY PART NO.*	PIN OR SKT	COLORBAND						
		□	○					
I.C. M39012/38-10 O.F. M39012/38-50	S —	RED —	WHI —	214 225 393	AF8 HX4		TH286 Y178	
I.C. M39012/38-10 O.F. M39012/38-51	S —	RED —	WHI —	213	AF8 HX4		TH286 Y178	
I.C. M39012/38-11 O.F. M39012/38-52	S —	BLU —	WHI —	142 400	AF8 HX4 HX3		TH286 Y142 X144	

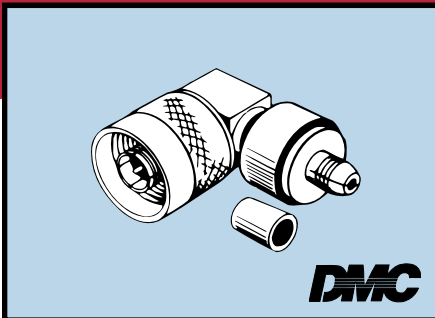

MIL-PRF-39012/39 SERIES SC

CONNECTOR TYPE	CONNECTOR MILITARY PART NO.
PLUG RIGHT ANGLE	M39012/39-0501
	M39012/39-0502
	M39012/39-0503

CONTACT GUIDE				APPLICABLE CABLE RG-/U	CRIMP TOOL		POSITIONER OR DIE	
CONTACT MILITARY PART NO.*	PIN OR SKT	COLORBAND						
		□	○					
I.C. M39012/39-10 O.F. M39012/39-50	S —	RED —	ORA —	214 225 393	AF8 HX4		TH285 Y178	
I.C. M39012/39-10 O.F. M39012/39-51	S —	RED —	ORA —	213	AF8 HX4		TH285 Y178	
I.C. M39012/39-11 O.F. M39012/39-52	S —	BLU —	ORA —	142 400	AF8 HX4 HX3		TH285 Y142 X144	

* I.C. - Inner Contact, O.F. - Outer Ferrule

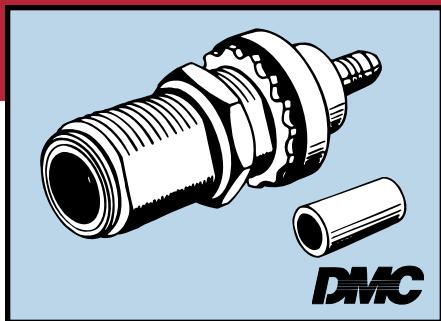

MIL-PRF-39012/40 SERIES SC

CONNECTOR TYPE	CONNECTOR MILITARY PART NO.
JAM NUT MOUNT	M39012/40-0501
	M39012/40-0502
	M30912/40-0503

CONTACT GUIDE				APPLICABLE ABLE RG-/U	CRIMP TOOL		POSITIONER OR DIE	
CONTACT MILITARY PART NO.*	PIN OR SKT	COLORBAND						
		□	○					
I.C. M39012/40-10	S	RED	GOL	214	AF8		TH286	
O.F. M39012/40-50	—	—	—	225	HX4			Y178
				393				
I.C. M39012/40-10	S	RED	GOL	213	AF8		TH286	
O.F. M39012/40-51	—	—	—		HX4			Y178
I.C. M39012/40-11	S	BLU	GOL	142	AF8		TH286	
O.F. M39012/40-52	—	—	—	400	HX4	HX3	Y142	X144

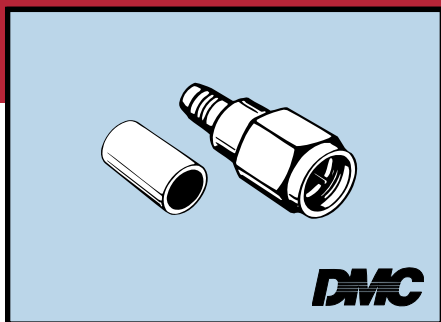

MIL-PRF-39012/55 SERIES SMA

CONNECTOR TYPE	CONNECTOR MILITARY PART NO.
PLUG PIN CONTACT	M39012/55-3502
	M39012/55-4502

CONTACT GUIDE				APPLICABLE CABLE RG-/U	CRIMP TOOL		POSITIONER OR DIE	
CONTACT MILITARY PART NO.*	PIN OR SKT	COLORBAND						
		□	○					
I.C. M39012/55-10	P	RED	SIL	142	AF8		TP485	
O.F. M39012/55-50	—	—	—		HX4	HX3	Y142	X144
I.C. M39012/55-10	P	RED	SIL	400	AF8		TP485	
O.F. M39012/55-50	—	—	—		HX4	HX3	Y142	X144

* I.C. - Inner Contact, O.F. - Outer Ferrule

R.F. Connectors Tool Selection Guide

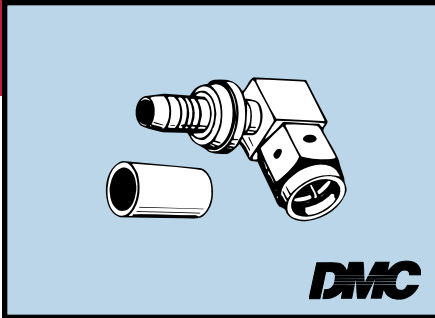

MIL-PRF-39012/56 SERIES SMA

CONNECTOR TYPE	CONNECTOR MILITARY PART NO.
PLUG RIGHT ANGLE	M39012/56-3502
	M39012/56-4502

CONTACT GUIDE				APPLICABLE CABLE RG-/U	CRIMP TOOL		POSITIONER OR DIE	
CONTACT MILITARY PART NO.*	PIN OR SKT	COLORBAND						
		□	○					
I.C. M39012/56-10 O.F. M39012/56-50	P	RED	MAR	142	AF8		TP485	
	—	—	—		HX4	HX3	Y142	X144
I.C. M39012/56-10 O.F. M39012/56-50	P	RED	MAR	400	AF8		TP485	
	—	—	—		HX4	HX3	Y142	X144

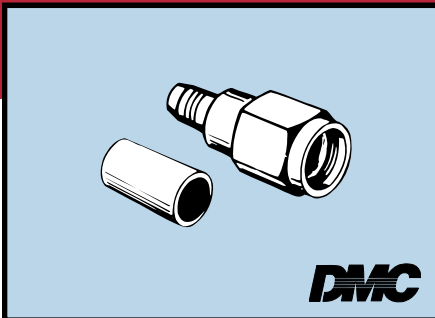

MIL-PRF-39012/57 SERIES SMA

CONNECTOR TYPE	CONNECTOR MILITARY PART NO.
PLUG SOCKET CONTACT	M39012/57-3502
	M39012/57-4502

CONTACT GUIDE				APPLICABLE CABLE RG-/U	CRIMP TOOL		POSITIONER OR DIE	
CONTACT MILITARY PART NO.*	PIN OR SKT	COLORBAND						
		□	○					
I.C. M39012/57-10 O.F. M39012/57-50	S	RED	MAR	142	AF8		TP485	
	—	—	—		HX4	HX3	Y142	X144
I.C. M39012/57-50 O.F. M39012/57-50	S	RED	MAR	400	AF8		TP485	
	—	—	—		HX4	HX3	Y142	X144

* I.C. - Inner Contact, O.F. - Outer Ferrule

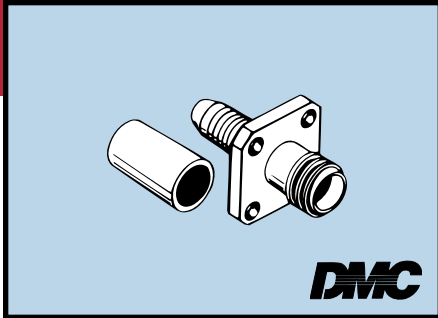

MIL-PRF-39012/58 SERIES SMA

CONNECTOR TYPE	CONNECTOR MILITARY PART NO.
RECEPTACLE FLANGE MOUNTED	M39012/58-3502
	M39012/58-4502

CONTACT GUIDE				APPLICABLE CABLE RG-/U	CRIMP TOOL		POSITIONER OR DIE	
CONTACT MILITARY PART NO.*	PIN OR SKT	COLORBAND						
		□	○					
I.C. M39012/58-10 O.F. M39012/58-50	S	RED	MAR	142	AF8		TP485	
	—	—	—		HX4	HX3	Y142	X144
I.C. M39012/58-10 O.F. M39012/58-50	S	RED	MAR	400	AF8		TP485	
	—	—	—		HX4	HX3	Y142	X144

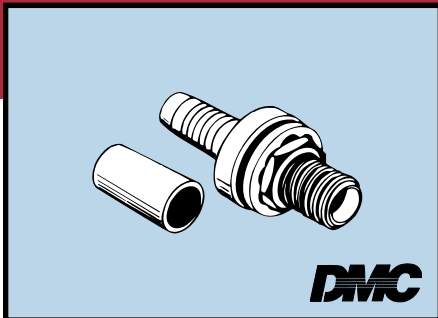

MIL-PRF-39012/59 SERIES SMA

CONNECTOR TYPE	CONNECTOR MILITARY PART NO.
JAM NUT MOUNTED	M39012/59-3502
	M39012/59-4502

CONTACT GUIDE				APPLICABLE CABLE RG-/U	CRIMP TOOL		POSITIONER OR DIE	
CONTACT MILITARY PART NO.*	PIN OR SKT	COLORBAND						
		□	○					
I.C. M39012/59-10 O.F. M39012/59-50	S	RED	MAR	142	AF8		TP485	
	—	—	—		HX4	HX3	Y142	X144
I.C. M39012/59-10 O.F. M39012/59-50	S	RED	MAR	400	AF8		TP485	
	—	—	—		HX4	HX3	Y142	X144

* I.C. - Inner Contact, O.F. - Outer Ferrule

Mid-Current Range Adjustable Indent Crimp Tools



For power supply and power management applications, DMC offers our Industrial Mid-Current Range Adjustable Crimp Tools which have virtually limitless applications within the specified **wire range of 6 through 18 AWG**. The tools are used widely in the marine, rail, power generation, solar, and heavy transportation industries.

The Mid-Current Range Adjustable Crimp Tools are similar to our Standard Adjustable Indent Crimp Tool but have an enlarged crimp cavity to accommodate mid-current power contacts. Turret heads and positioners are available to adapt the tool frames to your specific contact/wire combination. The 8 impression crimp assures absolute maximum tensile strength with almost every closed barrel contact. Special indent configurations are available upon request.

For proper operation, the tool must be mated with a multi-position turret head (or a single-position positioner. These are attached by orienting the positioner in the keyed position and by tightening the hex socket screws provided as part of the positioner.

A permanent dataplate is affixed to all turret heads and positioners. This plate lists specific contact part numbers, the corresponding position color code (for 3 position turret heads), and suggested selector depth settings for the wire size being used.

On most models, crimp depth is con-

trolled by a position selector knob located on the tool frame. The operator simply dials the desired step for the wire being used. This setting can be secured by use of a locking pin or safety wire.

As with our Military Standard crimp tools, the cycle controlled ratchet assures a complete crimp every time. The carefully engineered design achieves the absolute maximum mechanical advantage.

Periodic gaging is recommended to insure accurate calibration. This can be done easily by setting the tool selector knob to the designated position and checking indenter closure with the "GO/NO-GO" gage designated for each tool.

These tools measure 9¾" x 2½" x 1¼" approximately and weighs less than a pound.

NOTE: Crimping wires and contacts in this range requires increased hand force in comparison with other common hand crimpers, therefore use of this hand tool should be limited to short run production and maintenance applications.

Powered versions of these tools are available for production and repetitive use (see page 13).



The **M320** is designed for Siemens Industrial Automation contacts, 6FX2003 Series. The M320 crimps both the conductor and the insulation. This tool is not available in a pneumatic version.

M320 APPLICATIONS	
POSITIONER P/N	CONTACT MFG. & PART NUMBER
TH579-1	Siemens Industrial Automation 6FX2003-5AA00 (Conductor) Siemens Industrial Automation 6FX2003-5AB00 (Insulation)
TH580-1	Siemens Industrial Automation 6FX2003-5AC00 (12 & 16 Conductor, Insulation)
TH581-1	Siemens Industrial Automation 6FX2003-5AD00 (Conductor, Insulation)



The M300BT is designed for pin and socket contracts, **AWG sizes 6-14**. This tool is available in a pneumatic version, P/N WA27-300BT-EP.

M300BT APPLICATIONS	
POSITIONER P/N	CONTACT MFG. & PART NUMBER
SP587	BURNDY RC14P1EOPI-RC12P1EOPI & RC10P1EOPI
SP593	SOCAPEX CONTACTS-SOURIAU 8400 TOOL
SP604	DEUTSCH 047 1325 08 & 047 1326 08
SP708	DEUTSCH 1841-5-5608 & 18-007-08-9056
SP858	TYCO # 213552-2 2, 211161-1
TP1018	ROSEMONT SST SLEEVE
TP1029	(MAC MISSILE SYSTEMS) U.S. NAVY
TP1031	CROUSE HINDS 314263-110 PIN
TP1032	CROUSE HINDS 314262-110 SKT.
TP1033	BG SERVICE 22344-ASS'Y
TP1054	CROUSE HINDS A600568 MINI-CHANGE STYLE III, 600565
TP1055	CROUSE HINDS A600568 STYLE MINI-LINE, 600566 GRN PIN
TP1059	HARTING 09030006214, 09030006215
TP1060	CROUSE HINDS P1315209-270, -260, -250, -240, -230
TP1062	CROUSE HINDS P314262-150, -140, -130, -120
TP1064	CROUSE HINDS P1315366-130, -120, -110
TP1077	DELTA TECH SLEEVE STOP / COIL ASS'Y
TP1097	MULTI-CONTACT FRANCE 4FL 4 295 00
TP1111	AMPHENOL SOCAPEX 17DM53745-201, 17DM53744-201
TP1114	HYPERTRONICS YSK035-058GT
TP1151	TYCO 212007, 212008, 211159 & 211161
TP1159	RADIALL 616366
TP1169	BURNDY 82911679N

M300BT APPLICATIONS	
POSITIONER P/N	CONTACT MFG. & PART NUMBER
TP1188	AMPHENOL SOCAPEX 900198-91
TP1193	CKB S24923-000A3
TP1194	CKB S24924-000 A3
TP1222	WIELAND Z2 124 9521 0
TP1240	REF. FISCHER WIRE & PLASTIC
TP1286	MULTI-CONTACT 7-1261-01e & 7-2102-08
TP1318	FRAMATOME 8902-210 & 8902-225
TP1378	CORY CMP004-103 & FCT FMP004-13
TP1401	GAUTHIER G7500-P10-A0
TP1404	BURNDY 360J2224B7
TP714	SOURIAU 8476-28, 57888, 62622
TP799	8476-206
TP800	8476-207
TP823	RADIALL 282 551
TP826	ITT CANNON CDR897-0003, -0006
TP827	ITT CANNON CDR897-0004, -0007
TP852	CONTACT # E. F. JOHNSON P/N 12-2989-0528-7
TP870	ITT CANNON #031-0909-000, 031-0908-000
TP887	MULTI-CONTACT USA 05,0004
TP894	INTERCONNEXION CB-148-8-P, CD132-8-S
TP905	JUPITER M-8-MS, K-8-MS OCETA
TP907	AECMA EN3155-044, EN3155-045
TP908	FRB CONNECTRON 0350-24
TP910	FRB CONNECTRON 80-0200, 0200-47

M300BT APPLICATIONS	
POSITIONER P/N	CONTACT MFG. & PART NUMBER
TP916	SOURIAU 8819-118, 8819-119
TP924	SN 2377K100
TP927	LIVINGSTON 51469-1 (OCETA)
TP929	ELCON 702-31-01107
TP936	SOURIAU 8819-176 & -177
TP967	ITT CANNON 020436Y0000, 020437Y0000 SIZE 12
TP968	ITT CANNON 020434Y0000, 020435Y0000 SIZE 8 & 12
TP978	C.K.B. 0371-0004AS0, 0371-0003AS0
TP982	AMPHENOL 17-766-02
TP986	AIR LB P/N 001104-620 & 001104-630
TH558	BURNDY 3401040
TH579	Siemens Industrial Automation 6FX2003-5AA00 (Conductor) Siemens Industrial Automation 6FX2003-5AB00 (Insulation)
TH580	Siemens Industrial Automation 6FX2003-5AC00 (16 & 12 Conductor, Insulation)
TH581	Siemens Industrial Automation 6FX2003-5AD00 (Conductor, Insulation)
TH632	Siemens Industrial Automation 6FX2003-5AC00 (10 & 8 Conductor, Insulation)
TH640	Siemens Industrial Automation 6FX2003-4AB00 (Conductor, Insulation)
TH641	Siemens Industrial Automation 6FX2003-4AC00 (16 & 12 Conductor, Insulation)

Mid-Current Range Adjustable Indent Crimp Tools



The **M309** is designed for pin and socket contracts, **AWG sizes 8-18**. This tool is available in pneumatic versions, P/Ns WA27-309-2C, WA27-309, WA27-309-EP.

M309 APPLICATIONS	
POSITIONER P/N	CONTACT MFG. & PART NUMBER
TP1014	REF EWC
TP1058	HARTING 0903006213
TP1061	CROUSE HINDS P1315209-210
TP1063	CROUSE HINDS P314262-110
TP1067	CROUSE HINDS 1463105-110, -120, 1463106-110, -120
TP1071	FCT FMP002P-, 002P-A, ETC.
TP1072	FMP002 & -, 002S-A, ETC.
TP1073	FCT FMP01-, FMP043S
TP1074	FCT FMP018S -, FMP043S
TP1075	FMP018P -, 043P
TP1087	CROUSE HINDS 600221
TP1094	TYCO 193796-1, 193797-1, 193841-1, 19382-1
TP1116	POSITRONIC *C4008D, *C4012D, *C4016D
TP1122	M50130A
TP1123	T & B 222-14-148 OR HARTING 0903006215
TP1124	TYCO 2-194035-2, -4, -5, -7, -8, & 3-19035-1, -0, -3
TP1125	TYCO 194032-5, -7
TP1132	SOURIAU 8291-1682, 8-1683N
TP1138	CONMED 20063

M309 APPLICATIONS	
POSITIONER P/N	CONTACT MFG. & PART NUMBER
TP1141	NABSON 062095
TP1150	MULTI-CONTACT 32-0100 & 32-0500
TP1152	ODU 345 24 2315 401
TP1156	BOSTON SCIENTIFIC CORP. BURNDY CONNECTOR
TP1164	SODERBER DS0009B
TP1179	HYPERTRONICS YPN025-002G, YSK025-003AH, YPN025-003G, YSK025-004AH
TP1214	TYCO 212007-1 / 212008-1
TP1221	TYCO 194245
TP1224	TYCO 212013-1 & 212014-1
TP1235	TYCO 194189
TP1244	GM POWERTRAIN SOCKET CONTACT
TP1247	TYCO 193846-1
TP1264	CONEC 610FET1A
TP1265	CONEC 610FET2A
TP1266	BURNDY JVSP00080B & JVSS00080B
TP1284	HYPERTRONICS YSK025-031 & YPN025-024
TP1296	WIELAND Z2 124 9521 0
TP1317	GEOSERVICES 4805-136
TP1320	RETCONN 22-1013 & 22-1036



The **M300-25A** is designed for Pyle National Starline pin and socket contacts, **AWG sizes 10-18**. This tool is available in a pneumatic version, P/N WA27CL-25A.

M300-25A APPLICATIONS	
POSITIONER P/N	CONTACT MFG. & PART NUMBER
TP682-1	PYLE NAT. # 16 & #18
TP683-1	PYLE NAT. #12 PINS
TP684-1	PYLE NAT. #10 P&S, & #12 SOCKETS



The **M310** is designed for pin and socket contacts, **AWG sizes 8-16** and has an enlarged crimp cavity to accommodate oversized contacts.

M310 APPLICATIONS	
POSITIONER P/N	CONTACT MFG. & PART NUMBER
TP1008	US AIR F18008-08-9056
TP1013	TYCO 193796-1, 193797-1, 193841-1, 193842-1
TP1019	TYCO 193837-1
TP1020	TYCO 193837-2, -3
TP1021	TYCO 193673-1
TP1022	TYCO 193673-2, -3
TP1030	3M CD353
TP1040	ARRAY 806-0598-000 & 857-0590-130
TP1041	ARRAY 806-0599-00A, -00B & 857-0591-130/A, -130/B
TP1042	ARRAY 806-0599-000 & 857-0591-130
TP1068	TYCO 193990 & 193991 TYPE XII ("S" REMOVED PER AMP)
TP1088	TYCO 193991-1 & -3 ("S" REMOVED PER AMP)
TP1154	REF. AC & E INDUSTRIES
TP1162	HYPERTRONICS YPN006-124H
TP1216	POSITRONIC INDUS.
TP1232	HYPERTRONICS YPN035-005, -006, -007, YSK035-009, -010, -011
TP792	HYPERTRONICS YPN015-031, YSK015-041

M310 APPLICATIONS	
POSITIONER P/N	CONTACT MFG. & PART NUMBER
TP793	HYPERTRONICS YSK025-011 + -02, YPN025-009 + -010
TP802	FOR FRB CONTACTS 34-0300, 0300-12, 0300-17
TP806	FRB CONTACTS 0200-03, 0200-29, 0200-36 SOC.
TP807	FRB CONTACTS 31-0200, 58-0200, 64-0200 PIN
TP813	JUPITER CONTACTS BM-2611-5038ST-BF-201-150ST
TP814	FOR FRB CONTACT 29-0300
TP880	SMIT SLIKKERVEER #F-187306, #F-187307
TP890	FRB 0250-B-17G, -20G, 18-0250G, 20-0250G
TP891	FRB 13-0350G, 0350-B13G, 0350G, 0350-B-12G
TP902	HYPERTAC HST154 PIN, HST153 SKT
TP935	HYPERTRONICS YSK035-02G, ETC.
TP942	HYPERTRONICS YSK035-048
TP944	TYCO M310 USE TP944-1 WITH WA27-309-EP
TP965	FRB CONNECTRON 0300-20, 0300-24
TP974	POSITRONICS
TP999	CONNEI 16600,16601



The **M321** is designed for the rail transportation industry.

M321 APPLICATIONS	
POSITIONER P/N	CONTACT MFG. & PART NUMBER
TP1002	CKB CC1000C0M006, CC1000C0F006
TP1023	CKB SE0801-109 & SE0801-108
TP1024	CKB S24296-000B3 & S24263-000B3
TP1035	CKB S24265-000A3
TP1036	CKB S24298-000A3
TP1044	SOURIAU 8819-176, -177 (SIMILAR TP936 EXCEPT FOR M317)
TP1045	SOURIAU 8819-118, 8819-119
TP1052	BURNDY J383S1K-0006A01, J383P1K-0006A01
TP1065	CKB SE1239-007 (P), SE0692-130 (S)
TP1080	CKB 669-65 & 669-67
TP1131	AMPHENOL SOCAPEX 17DM53744-201, -206, -207, 17DM53745-201, -207, -208
TP1161	F.C.F. 10A-8638PPC100X, 10A-8638PSC100X, 20A-8638PPC200X, 20A-8638PSC200X, 40A-8638PPC400X, 40A-8638PSC400X
TP1163	FRB CONNECTRON 0200-47/80-0200
TP1338	CKB SOCKET CONTACT
TP1339	CKB PIN CONTACT
TP805	FRB CONTACTS 0350B11, -B12, -B13, 11-0350, 12-0350, 13-0350
TP909	FRB CONNECTRON 0200-42, 73-0200
TP911	FRB CONNECTRON 0300-21, 0300-17, 34-0300, 0300-23, 39-0300
TP912	FRB CONNECTRON 38 0300
TP957	HARTING 0932 000 6107, 6207, 6108, 6208
TP971	C.K.B. 0572-1016A4A

OTHER MID-RANGE TOOLS

The **M316** is designed for crimping Sundstrand Aviation contacts #5905143 onto 16 AWG solid wire.

The **M322** is designed for Therm-X Terminal Assembly (pin and socket) contacts.

The **M327** is designed for Greene Tweed 5672-1998 (pin and socket) contacts.



Circular Indent Crimp Tools

CIRCULAR CRIMP TOOLS

DMC makes a range of Circular Indent Crimp Tools used primarily for outer shield terminations in contacts. These tools are capable of crimping a circle as small as 0.040" and as large as 0.262". Due to the nature of crimping a complete circle, with four equal segments each tool is specified for a certain diameter. See the charts on this page for diameter sizes and part numbers.

CIRCULAR CRIMP TOOLS BY CRIMP DIMENSION		
CIRCULAR CRIMP DIMENSION	TOOL P/N	GAGE
0.042-0.046"	GS210	G925
0.061-0.065"	GS205	G450
0.065-0.099"	GS8-3	G941
0.080-0.084"	GS212	G732
0.086-0.090"	GS225	G919
0.093-0.097"	GS221	G881
0.096-0.100"	GS222	G120
0.124-0.128"	GS223	G917
0.140-0.144"	GS226	G1056
0.142-0.146"	GS218	G443
0.154-0.158"	GS201	G446
0.156-0.160"	GS101	G445
0.167-0.171"	GS227	G1057
0.190-0.194"	GS219	G848
0.197-0.201"	GS208	G533
0.234-0.238"	GS213	G926
0.258-0.262"	GS206	G426

CIRCULAR CRIMP TOOLS BY PART NUMBER		
TOOL P/N	CIRCULAR CRIMP DIMENSION	GAGE
GS101	0.156-0.160"	G445
GS201	0.154-0.158"	G446
GS205	0.061-0.065"	G450
GS206	0.258-0.262"	G426
GS208	0.197-0.201"	G533
GS210	0.042-0.046"	G925
GS212	0.080-0.084"	G732
GS213	0.234-0.238"	G926
GS218	0.142-0.146"	G443
GS219	0.190-0.194"	G848
GS221	0.093-0.097"	G881
GS222	0.096-0.100"	G120
GS223	0.124-0.128"	G917
GS225	0.086-0.090"	G919
GS226	0.140-0.144"	G1056
GS227	0.167-0.171"	G1057
GS8-3	0.065-0.099"	G941



DEDICATED APPLICATION CIRCULAR CRIMP TOOLS

Some of our Circular Crimp Tools already have turrets & positioners custom designed to accommodate common contacts.

DEDICATED APPLICATION CIRCULAR CRIMP TOOLS				
TOOL P/N	APPLICATION	CRIMP DIMENSION	GAGE	POSITIONERS AVAILABLE
GS100-1	Tyco, Amphenol, & Radiall Contacts (See Chart)	0.096-0.100"	G120	6
GS200-1	Amphenol/Bendix, Radiall, & Tri-Star Contacts (See Chart Below)	0.142-0.146"	G443	5
GS209	Amphenol Intermediate Contacts 21-33197-10, 21-33198-10	0.154-0.158"	G446	1
GS212	Amphenol & Sabritec Contacts (See Chart Below)	0.080-0.084"	G732	10
GS218	Amphenol Contacts 10-589514-126, NZGC-X50-12PB-5, NZGC-X50-12SB-5, NZGC-X75-12PB-6, NZGC-X75-12SB-6	0.142-0.146"	G443	1
GS222	Positronic MC11NS, FC112N2S, FC112N2S-1565.0	0.096-0.100"	G120	1
GS223	Positronic FC610N2S, MC610NS, SK4195, SK4196	0.124-0.128"	G917	2
GS225	Amphenol 21-33908-29, 21-33909-29	0.086-0.090"	G919	1
GS227	Deutsch Contact 59155-000-Socket, 59155-000-Pin	0.167- 0.171"	G1057	1
GS2XE	Unstripped Wire End Caps Pneumatic Version: WA27XE-EP	0.123-0.129 0.134-0.140	G719	1
GS8-3	8 Step Tool	0.065-0.099"	G941	1

POSITIONER LIST FOR GS100-1	
POSITIONER	CONTACT MFG. & P/N
GP1256	AMPHENOL 21-33655-5
GP295	SINGLE POSITIONER MIL-C-24308 OUTER PIN & SOC.
GP385	AMP P71-2979-3,4,5,6 , P71-2980-1,2
GP425	AMP P71-2979-3, 4, 5, 6 & P71-2980-1, 2
GP475	AMP P71-2979 , P71-2980
GP926	RADIALL EPX 617130, 617131, 617132, 617030, 617031, 617032

POSITIONER LIST FOR GS200-1	
POSITIONER	CONTACT MFG. & P/N
GP1596	TRI-STAR 317-16CX-091
GP1256	AMPHENOL 21-33655-5
GP781	INTERMEDIATE BRAID #10 TRIAXIAL CONTACT
GP926	RADIALL EPX 617130, 617131, 617132, 617030, 617031, 617032
G2P330	#12 BENDIX COAX GS200

POSITIONER LIST FOR GS209	
POSITIONER	CONTACT MFG. & P/N
TH551	Amphenol 21-33197-10, 21-33198-10 Intermediate Contact

POSITIONER LIST FOR GS212	
POSITIONER	CONTACT MFG. & P/N
GP1015	DEUTSCH 533 433-4
GP1120	AMPHENOL 21-33908-3 ASS'Y
GP1121	AMPHENOL 21-33909-3 ASS'Y
GP1243	AMPHENOL 21-33754-2
GP1613	AMPHENOL 21-33908-25 & 21-33909-25
TH553	Amphenol Intermediate Contacts L-38151-897, L-38151-907
TP1359	SABRITEC SL-10
TP1360	SABRITEC SL-12
TP1361	SABRITEC SL-14
TP1369	SABRITEC SL-16

POSITIONER LIST FOR GS223	
POSITIONER	CONTACT MFG. & P/N
TP1386	POSITRONIC FC610N2S & MC610NS
TP1458	POSITRONIC SK4195 & SK4196

POSITIONER LIST FOR GS222	
POSITIONER	CONTACT MFG. & P/N
TP1366	POSITRONIC MC112NS; FC112N2S; FC112N2S-1565.0

POSITIONER LIST FOR GS225	
POSITIONER	CONTACT MFG. & P/N
GP1611	AMPHENOL 21-33908-29 & 21-33909-29

Special Application Indent Crimp Tooling

To keep pace with the most recent developments in technology, DMC is often called upon to custom engineer tooling for the medical, telecommunication, electronics, aerospace, and alternative energy industries. Some of these applications require unique indent configurations, special materials, and multi-stage crimps. Some of the special application tools we've developed in the past are listed on the following pages.

DMC is ready and capable to help satisfy your tooling needs with custom engineered tools and dies. Contact us with your requirements.

FINE TIPPED INDENTER TOOLS (MODELS MH835 & MH992)

The **MH835 & MH992** Fine Tipped Indenter tools are similar to the AFM8 miniature adjustable indent crimp tool, but have sharper indenter tips measuring .07 inches. The **MH835** tool produces a 4-indent crimp while the **MH992** tool produces an 8-indent crimp.

The **MH835** has eight crimp settings from 0.0070" to 0.0325" and is gaged with the G619 Go/No-Go gage. The pneumatic power version of this tool is the **WA22BH**.

The **MH992** has eight crimp settings from 0.0070" to 0.0330" and is gaged with the G822 Go/No-Go gage. The tool is 6¾" in length and weighs approximately 10 oz. The pneumatic power version of this tool is the **WA22AE**.

MH835 POSITIONERS		
P/N	DESCRIPTION	PURPOSE
K1618	POSITIONER	2999803003 Cinch
K1643	POSITIONER	B882D05 ATI
K1688S	POSITIONER	92286 NDC Nitinol
K1705	POSITIONER	D4601-L3 Signal Integrity
K1706	POSITIONER	E5656-H8 Signal Integrity
K1735S	POSITIONER	100.005.955 Kistler
K1754SP	POSITIONER	8300-0165 Ulti-Mate
K1761SP	POSITIONER	30/30/00/000 Glenair
K1762	POSITIONER	31/30/00/000 Glenair
G619	GAGE	Go-No Go Test for MH835
Other Positioners Available		

MH992 POSITIONERS		
P/N	DESCRIPTION	PURPOSE
K1072	POSITIONER	Tri-Tech
K1183S	POSITIONER	D1003, Eli Connectors
K1303	POSITIONER	M39029/102-559 SKT
K1304	POSITIONER	M39029/103-559 PIN
K1360	POSITIONER	21-33664-7M, 21-3365-7M Amphenol
K1409	POSITIONER	Rosenberger
K1597	POSITIONER	Packets D-G Cook Inc
K1605	POSITIONER	6362-223-1231 Deutsch
K1624	POSITIONER	2999804004 Cinch
K1631	POSITIONER	6362-226-1231, 6362-227-1231 Deutsch
K1632	POSITIONER	Medical Implant Cochler
K1702S	POSITIONER	.028x.100LG Ferrule Accellent
K1704S	POSITIONER	#12 Quadrax Pin/Socket W. L. Gore & Assoc
K1709S	POSITIONER	3362-204-1231 Deutsch
K1721	POSITIONER	859-006 Glenair
K1730S	POSITIONER	857-000-280 Ultra Precision
K1733S	POSITIONER	3061-0-19-xx-21-xx10-0 MIII-Max
K1734S	POSITIONER	ETH4-0011A-D ETH4-0012A-D Souriau
K1739S	POSITIONER	1996972-2 Tyco
K1744	POSITIONER	610870 Deutsch
K1751S	POSITIONER	TEM Samtec
K1752S	POSITIONER	C-295-XX-X Samtec
K1755	POSITIONER	1996972-2 Tyco
K1756	POSITIONER	1996972-4 Tyco
K1764	POSITIONER	BNC7T-P-C-M-ST-CA6-PIN Samtec
G822	GAGE	Go-No Go Test for MH992
Other Positioners Available		



Special Application Indent Crimp Tooling

ULTRA PRECISION CRIMP TOOL (MODEL MH800)

All DMC tools are designed and built to the highest standards of precision and quality, but some applications call for more. One such case is contacts which have extremely thin wire barrel dimensions. The answer to this demand is the model **MH800** Ultra Precision Crimp Tool which utilizes the same basic components as the Model AFM8 (M22520/2-01) Crimp Tool with tighter gaging tolerances and a special indenter tip configuration that assures a uniform flow of metal during the crimping operation.

The model **MH800** accommodates wire sizes 20 thru 32 AWG (the miniature to sub-miniature range). It accommodates the K series or M22520/2-XX positioners and is easily identified by a distinctive orange handle grip. It is 6¾" in length and weighs approximately 10 oz. Gaging is accomplished with the G100 "GO/NO-GO" gage. The pneumatic power version of this tool is the WA22H.



MH800 POSITIONERS		
P/N	DESCRIPTION	PURPOSE
K4	POSITIONER	2202-16-0101 PIN, 2203-8-0101 PIN STK Deutsch
K5	POSITIONER	2202-17-0101 SOC, 2203-9-0101 SOC STK Deutsch
K30C	POSITIONER	Deutsch Coax
K127	POSITIONER	2841-5-++00 RSM 2803-4-++00 RSM 100060-++TJ 2841-13-++00 RSM 2803-10-++00 RSM Deutsch
G100	GAGE	Go-No Go Test for MH800
Other Positioners Available		

STEEL INDENTER CRIMP TOOL (MODEL MH820 & MH820P)

The **MH820** Steel Indenter Crimp Tool is similar to the AFM8 miniature adjustable indent crimp tool, but has indenters made from steel to crimp harder materials and extend the indenter life.

The **MH820** has eight crimp settings from 0.011" to 0.038" and is gaged with the G212 Go/No-Go gage. The tool is 6¾" in length and weighs approximately 10 oz. The pneumatic power version of this tool is the WA22M.



MH820 POSITIONERS		
P/N	DESCRIPTION	PURPOSE
AC702	POSITIONER	Meditech Wire Brush
K166	POSITIONER	294-1514 Mini-Tac Pin Amphenol
K277	POSITIONER	221-759P, 357- 301-03 Amphenol
K278	POSITIONER	221-760S, 357- 301-04 Amphenol
K1572SP	POSITIONER	582-110-2828 (Socket) Amphenol
K1573	POSITIONER	582-110-28283 Amphenol
K1740S	POSITIONER	ACB4P, ACB4S Center Contact Axon
G212	GAGE	Go-No Go Test for MH820
Other Positioners Available		

Special Application Indent Crimp Tooling

BIASED CRIMP TOOLS (MODELS SC8 & MH993)

Our Biased Crimp tools have a 4 indent pattern with the flat-tipped indenters that are offset at an angle of 45 degrees to produce a radial or spiral pattern around the application, typically a seamed or formed barrel contacts. This indent pattern is also useful for holding springs (or spring like devices) to a tube or solid rod. We offer two Biased Crimp tools, the SC8 for sizes 12 thru 26 AWG and the MH993 for 20 thru 32 AWG.

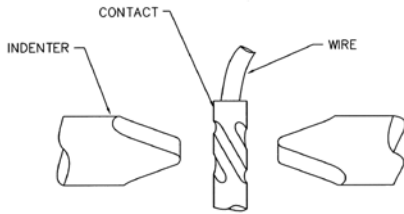

The model **SC8** has single flat-tipped indenters and accommodates wire sizes 12 thru 26 AWG. It accommodates the TP series positioners. It is 9¾" in length and weighs approximately 15 oz. Gaging is accomplished with the G125 "GO/NO-GO" gage.

The pneumatic power version of this tool is the WA27AJ.

The model **MH993** has double tipped indenters and accommodates wire sizes 20 thru 32 AWG (the miniature to sub-



miniature range). It accommodates the K series positioners. It is 6¾" in length and weighs approximately 10 oz. Gaging is accomplished with the G125 "GO/NO-GO" gage.

The pneumatic power version of this tool is the WA22BC.



SC8 BIASED CRIMP TOOL		
DMC P/N	DESCRIPTION	PURPOSE
TP1189	POSITIONER	CONXALL 680-SG (SC8)
TP1190	POSITIONER	CONXALL 586-SG (SC8)
TP1191	POSITIONER	CONXALL 5053-20 GS (SC8)
TP1621	POSITIONER	CONXALL 587-PGN5 & 586-SUN
G125	GAGE	Go-No Go Test for SC8



MH993 BIASED CRIMP TOOL		
DMC P/N	DESCRIPTION	PURPOSE
K484	POSITIONER	65-275-1 (26-30), 65-275-2 (20-24)
K1287S	POSITIONER	610-110-101 Virginia Panel
K1732	POSITIONER	587-PGN5 Conxall
K1749	POSITIONER	587-PGN Conxall
G125	GAGE	Go-No Go Test for MH993

Dedicated Application Indent Crimp Tooling

TWO-LEVEL INDENT CRIMP TOOL FOR BURNDY YHMM SERIES CONTACTS (MODEL LH8)

The **LH8** tool produces both conductor and insulation crimps simultaneously on Burndy YHMM series contacts used in many aircraft wiring systems (Boeing contact designations BACC47DE4 & BACC47DE5). It is functionally comparable to the Burndy M10S-1 crimp tool with S1 Die & SL-53 Stop Bushing (Combination).

The tool comes with a dedicated turret head positioner, LH281. It is gaged with gages G687 for the conductor & G743 for the insulation. The tool is approximately 9¾" x 2½" x 1¼" and weighs 15 oz. The pneumatic power version of this tool is the **WA27LH**.



MIL-C-22442/32-1 CLAMPING RING CRIMP TOOL

The **GS217** is designed to crimp clamping and retaining rings onto cable or wire in accordance with MIL-C-22442/32-1. The tool has 3 selector settings which crimp from 0.150 to 0.195". The tool is approximately 9¾" x 2½" x 1¼" and weighs 15 oz.

The pneumatic power version of this tool is the **WA27AD**.

The assigned Turret Head is the **SH556** which accepts cable diameters from 0.110" to 0.195". Positioner **TP975** is also available to crimp Astrocom Electronics' Clamping Ring P/N 20822.



Other special indent tools are available, please consult DMC.

GMT Series Precision Crimp Tools

DMC provides custom and standard crimp tools manufactured to OEM connector supplier or user requirements. Often these tools are specified as comparable in function to the OEM connector supplier tool. Numerous applications such as open barrel (stamped and formed) contacts, insulated and non-insulated terminals, splices, end caps, coaxial connectors, and wire fittings of all types are covered by these tools. The rugged construction of this tool assures repeatability and long life cycle. You can rely on DMC experience for quality and cost effective performance.

GMT General Purpose Tools: Many standard OEM applications are covered by the GMT general purpose tool series. The jaws are fixed, and the locator (where used) is configured to hold the contacts precisely in the correct location for optimum crimping.



Pneumatic & Battery tools are available to cover the GMT tool series. See page 103 for part numbers.

GMT1090 (M22520/44-01) TOOL FOR M81824/12-XX COLD APPLIED SPLICES

The **GMT1090 (M22520/44-01)** Hand Crimp Tool crimps Tyco's Cold Applied Environmental Splices (M81824/12-xx) sizes 26-20, 20-16, 16-12 AWG. This precise tool has a locator which is configured to hold the splice in the correct location while either wire is being terminated. No heat, or heat gun, required. Pneumatic Equv **PMT1090**



GMT232 (M22520/37-01) TOOL FOR M81824/1-XX ENVIRONMENTAL SPLICES

The **GMT232 (M22520/37-01)** Hand Crimp Tool crimps low profile environmental splices (M81824/1-xx). The GMT232 is the most popular tool to cover the range of 12 (yellow), 16 (blue), and 20 (red) splices for low profile environmental splice applications. The GMT232 has a locator which is configured to hold the splice in the correct location while either wire is being terminated. This tool is comparable to the popular Tyco AD1377. Pneumatic Equv **PMT232**



GMT1005 TOOL FOR UNINSULATED TERMINALS

The **GMT1005** Hand Crimp Tool terminates uninsulated terminals sizes 10 to 22 AWG. This tool is comparable to Tyco Electronics' 49935 hand tool. Pneumatic Equv **PMT1005**



GMT TOOL SERIES PART NUMBERS				
HAND TOOL P/N	BATTERY TOOL P/N	REMOTE HEAD BATTERY TOOL P/N	PNEUMATIC TOOL P/N	APPLICATION / DESCRIPTION
GMT201	GMTEB201	GMTE201-R	PMT201	Molex .093" Dia Standard Pin & Socket Terminals, Clapscon Series
GMT202	GMTEB202	GMTE202-R	PMT202	Molex .062" Dia Standard Pin & Socket Terminals, KK, Flat Blade, Pitch Crimp
GMT203	GMTEB203	GMTE203-R	PMT203	Molex .156" KK Trifurcon Series
GMT204	GMTEB204	GMTE204-R	PMT204	Molex .093" Dia Clapscon Series
GMT206	GMTEB206	GMTE206-R	PMT206	ITT Cannon Zif Connector, Series DL
GMT208	GMTEB208	GMTE208-R	PMT208	Tyco Multimate Type III+ Series
GMT209	GMTEB209	GMTE209-R	PMT209	Elco 60-8017-0313
GMT211	GMTEB211	GMTE211-R	PMT211	Tyco PCB Terminals and Disconnects, .058" Dia
GMT220	GMTEB220	GMTE220-R	PMT220	Tyco Type XI Contacts
GMT221	GMTEB221	GMTE221-R	PMT221	Rockwell Collins Thin-Line I & II
GMT225	GMTEB225	GMTE225-R	PMT225	Tyco AMPMODU Series Type MOD IV Contacts
GMT226	GMTEB226	GMTE226-R	PMT226	Tyco Amplimate Series, Size 20DF
GMT230	GMTEB230	GMTE230-R	PMT230	Tyco AMPMODU Series Type IV, IV1/2 & V Contacts
GMT232	GMTEB232	GMTE232-R	PMT232	M22520/37-01 tool for M81824/1-X Splices Tyco (Raychem) "Mini-Seal" Environmental Splices (26-20, 20-16, 16-12)
GMT241	GMTEB241	GMTE241-R	PMT241	Tyco CPC Series, Size 20DF Contacts
GMT245	GMTEB245	GMTE245-R	PMT245	Tyco Mate-N-Lok Series 60620-() and 60619-()
GMT247	GMTEB247	GMTE247-R	PMT247	ITT Cannon D-Sub Economy Standard Size 20
GMT248	GMTEB248	GMTE248-R	PMT248	Comparable to Pyle-National TP-201389 (w/ Cutter)
GMT260	GMTEB260	GMTE260-R	PMT260	ITT Cannon DL Series ZIF Contacts, CCT-DL-3
GMT262	GMTEB262	GMTE262-R	PMT262	Tyco Amp-TAB Series 66168, 66143, 66169, 66144
GMT263	GMTEB263	GMTE263-R	PMT263	Teradyne 600-0026-000 I/O Series Contacts
GMT277	GMTEB277	GMTE277-R	- -	M22520/38-01 for MS20659 Uninsulated Ring terminals size 22 through 10 and MS25486 external power plug socket contact size 12 (Supersedes M22520/24-01)
GMT286	GMTEB286	GMTE286-R	PMT286	Tyco Contact 925576
GMT295	GMTEB295	GMTE295-R	PMT295	Tyco Locking Clip Contact 87165
GMT302	GMTEB302	GMTE302-R	PMT302	ITT Cannon CCT-UBC
GMT309	GMTEB309	GMTE309-R	PMT309	Amp Tyco tool 144969-2
GMT1005	GMTEB1005	GMTE1005-R	- -	Uninsulated Terminals (Tyco Tool 49935)
GMT1090	GMTEB1090	GMTE1090-R	- -	Tyco Cold Applied Environmental Splice (26-20, 20-16, 16-12)

Battery Powered Hydraulic GMT Series Crimp Tools

DMC is pleased to present our GMT Series battery powered hydraulic tools to crimp open barrel (stamped and formed) contacts, insulated and non-insulated terminals, splices, and end caps, coaxial connectors, and wire fittings of all types are covered by these tools. Just like with the hand tools, locators are included for applications where they are needed to hold contacts in the correct location for optimum crimping.

GMTEBxxx

The **GMTEBxxx** Series Battery Powered Hydraulic Commercial Standard Crimp Tools are hand held, self-contained crimp tools. The crimp head, battery, and pump unit are contained in one ergonomic tool body and weigh about 4 pound each. They are comparable to DMC's GMT Series hand tools.

TOOL INCLUDES: Carrying Case, Two 18v Batteries (p/n HDE-LI-B), One Battery Charger (p/n HDE-LI-120C).



GMTEB232 FOR M81824/1-XX ENVIRONMENTAL SPLICES

GMTEB232 Tool is the battery powered version of our GMT232 (M22520/37-1) hand tool for low profile environmental splices (M81824/1-XX). The **GMTEB232** is the most popular GMT Series tool to cover the range of 12 (yellow), 16 (blue), and 20 (red) splices for low profile environmental splice applications. This precise tool has a locator which is configured to hold the splice in the correct location while either wire is being terminated.

FEATURES

- Ergonomic design allows one-handed operation
- Jaws remain closed under spring pressure (pinch sides to open/load)
- Head rotates 350 degrees
- Red LED to display the charge status of the battery

CRIMP CAPACITIES

- Max. Crimp Force: 4 Tons (35.6 kN)
- Avg. Crimp Time: 3 seconds
- Avg. Crimps per Charge: 100
- Avg. Charge time: 15 minutes

SPECIFICATIONS

- Length: 13" (330 mm)
- Width: 2.87" (72.9 mm)
- Depth: 4.5" (114.3 mm)
- Weight (with battery): 2.8 lb (1.3 kg)
- Hydraulic Oil: Shell Tellus® T-15 (or equivalent)



GMTExxx-R REMOTE HEAD BATTERY POWERED HYDRAULIC CRIMP TOOLS

The GMTExxx-R Remote Head Battery Powered Hydraulic Crimp Tools are hand held, self-contained crimp tools. The crimp head is separate from the battery and pump unit by a hydraulic umbilical cord. This reduces the held weight to 2 pounds, about the same as the hand tool.

These tools are equivalent to DMC's GMT Series hand tools.

The battery and pump unit can be worn by the operator on a tool belt, stored in a carrying case, or mounted to a bench top.

TOOL INCLUDES: Two Batteries (p/n HD-BATTERY-R), One Battery Charger (p/n HD-110CHARGER-R).

Tool Belt, AC Adapter, and Bench Mount sold separately.

FEATURES

- Ergonomic design allows one-handed operation
- Jaws remain closed under spring pressure
- Connection point for tool balancing systems

CRIMP CAPACITIES

- Max Crimp Force: 3500lb/15.6kN Max
- Oil Pressure: 4000psi/276 bar Max
- Crimp Time: Approx. 3.5 seconds
- Crimps per Charge: Approx. 250 (May vary with crimp force requirements & battery life.)



The battery and pump unit can be worn on a tool belt (p/n 2063863-1) ...

TOOL SPECIFICATIONS

CRIMP TOOL

- Length: 9.25"/235mm
- Width: 2.5"/63.5mm
- Depth: 2.5"/63.5mm
- Mass/Weight: 2.02lb/.916kg
- Sound Level: 72db
- Hose Length: 4.5ft

POWER UNIT (With Battery Installed)

- Length: 9.8"/248mm
- Width: 3.1"/80mm
- Depth: 5.6"/142mm
- Weight: 4.3 lb/2.0 kg
- Sound Level: 72 dBA
- Hydraulic Oil: 1.7 oz./ 48g Shell Tellus* T15
- Charging Voltage: 10.8 VDC Lithium Ion Battery
- Charging Time: 40 Minutes (Approximately)

GMTE232-R FOR M81824/1-XX ENVIRONMENTAL SPLICES

GMTE232-R Tool is the battery powered version of our GMT232 (M22520/37-1) hand tool for low profile environmental splices (M81824/1-XX). The GMTE232-R is the most popular GMT Series tool to cover the range of 12 (yellow), 16 (blue), and 20 (red) splices for low profile environmental splice applications (Tyco Mini-Seal). This precise tool has a locator which is configured to hold the splice in the correct location while either wire is being terminated.



used with an AC Adapter (p/n HD-110AC)...



or mounted to a bench top (p/n BM-7).

DCT Series Crimp Tools

DMC provides custom and standard crimp tools that are manufactured to connector OEM or user requirements. Often these tools are specified as comparable in function to the OEM connector supplier tool.

The DCT series of crimp tools and dies accommodate most (insulated and uninsulated terminals and splices conforming to AS7928 insulated and uninsulated as well as numerous proprietary configurations. Dies in various crimp patterns are also available for D-Subminiature, circular connectors, Red/Blue/Yellow "Heat-N-Seal" terminals, "MiniSeal" terminals, and low profile environmental splices (M81824/1-XX).

Dies are configured with single, double, triple and even quadruple crimp cavities.

Several models and types of tools comprise the DCT tool series. Some tools have removable (interchangeable) dies, and others have fixed cavities that are not removable.

If your application requirement is not already covered by one of our standard die sets, our engineering department will be pleased to discuss a design to suit your needs, consult DMC for details.



DCT4-XXX SERIES HAND CRIMP TOOLS

The sturdy construction of the DCT hand tools is superior to any tool made today. The handle will not flex or bend in any direction, therefore the maximum force and repeatability are achieved. The precision ratchet controls cycling of the tool and assures the same accurate crimp every time. The handle grips and the leverage system are designed for maximum ergonomic benefit.

The DCT tools are approximately 9¼" x 3½" x 1¼" and weigh 1.38 lbs.



DCTE4B-XXX SERIES BATTERY POWERED HYDRAULIC CRIMP TOOL

The DCTE4B Battery Powered Crimp Tools offer the portability of a hand tool with the stamina of a power tool! They are hand held, self-contained hydraulic crimp tools intended for use with DMC's "DCT4" Dies.

The DCTE4B battery tools are approximately 13.25" long, 2.87" wide, and 4.5" deep, weigh 2.8 lb with the battery installed.

TOOL INCLUDES: Carrying Case, Two 18v Batteries (p/n HDE-LI-B), One Battery Charger (p/n HDE-LI-120C).

FEATURES

- Ergonomic design allows one-handed operation
- Die automatically opens when crimp is complete
- Head rotates 350°
- Red LED to display the current status of the unit
- Accepts dies from other sources (consult DMC)
- Positive Cycle Control Pressure Sensing Design



DCT4 TOOL SERIES DIES	
DIE P/N	DESCRIPTION
DCT4-101D	Insulated Spare Wire Caps Comparable to AMP 58573-1
DCT4-102D	R/B/Y Insulated Terminals & Splices #22-18 AWG, 16-14 AWG, 12-10 AWG
DCT4-104D	R/B/Y ROSTRA HEAT-N-SEAL
DCT4-105D	Uninsulated Terminals
DCT4-106D	RF Connectors .178/ .128 hexes
DCT4-107D	RF Connectors .068/.178/.324 hexes
DCT4-108D	.068/.213/.255 hexes
DCT4-109D	.213/.128/.105 hexes
DCT4-110D	TROMPETER CD3-2 with .324/.255/.068/.042 hexes
DCT4-111D	COAXIAL AND FIRE BOTTLE CAP INDICATOR .128 hex
DCT4-117D	.255/.213/.178/.128 hexes
DCT4-118D	.213/.178 hexes
DCT4-119D	Insulated Terminals & Splices # 24-20 AWG, # 22-18 AWG, AND # 16-14 AWG w/ Locator
DCT4-120D	RG58/U, RG59/U, RG62/U .359/.255 hexes
DCT4-121D	.039 square/ .195 hexes
DCT4-122D	Insulated Terminals & Splices # 24-20 AWG, #22-18 AWG AND #16-14 AWG
DCT4-124D	.068 / .128 / .178 hexes Comparable to Amphenol CTL-9
DCT4-128D	.211/.128/.105 hexes CANNON CCT-DM Comparable to DieY322
DCT4-129D	Same configuration as M22520/37-1 for M81824/1-X Splices Tyco (Raychem) "Mini-Seal" Environmental Splices (26-20, 20-16, 16-12)
DCT4-130D	SUB-D CONTACTS 20-24/24-28
DCT4-138D	Coaxial Crimp Tool .264/.161 hexes
DCT4-139D	.264/.220 hexes
DCT4-140D	.433/.402 hexes
DCT4-141D	B-CRIMP COND. & INS. 16-22 AWG, 14-16 AWG, 10-12 AWG
DCT4-142D	with .142/.112/.079 hexes
DCT4-144D	Coaxial Crimp Tool .359/.290 hexes
DCT4-145D	Coaxial Crimp Tool .454 hex
DCT4-147D	.429/.100/.068 hexes
DCT4-148D	.268/.178 hexes, .057 dia.

DCT4 TOOL SERIES DIES	
DIE P/N	DESCRIPTION
DCT4-149D	COAXIAL CABLE ST212, ST214, BT2002, BT3002 .268/.213/.178/.150 hexes
DCT4-151D	D-SUBMINIATURE 20-30 AWG
DCT4-154D	.028 / .047 SQ, .128 / .178 Hexes
DCT4-155D	.028 / .047 SQ, .15 / .268 Hexes
DCT4-157D	.211 / .252 / .068 hexes
DCT4-158D	.212 / .252 / .066 hexes
DCT4-160D	.041 gage for "B" crimp
DCT4-161D	.041 gage for "B" crimp
DCT4-162D	.042 gage for "B" crimp
DCT4-163D	.290 DIA cavity
DCT4-166D	.187 / .178 hexes, .042 SQ Comparable to Amphenol CTL-15
DCT4-167D	.324 / .319 / .255 hexes, .042 SQ Comparable to Amphenol CTL-14
DCT4-169D	.324 / .255 / .068 hexes, .052 SQ Comparable to Amphenol CTL-8
DCT4-170D	.290 / .128 / .105 hexes
DCT4-173D	Rosenberger 88K20K-0S-3H3
DCT4-175D	AMP Multimate III & VI
DCT4-176D	Comparable to DIE Y498
DCT4-178D	"B" Crimp
DCT4-179D	"B" Crimp
DCT4-180D	Tyco AMPMODU Series Type IV, IV1/2 & V Contacts Comparable to AMP 90340
DCT4-181D	Molex 734154550 (1 of 2)
DCT4-182D	Molex 734154550 (2 of 2)
DCT4-183D	.339 Hex
DCT4-185D	White and Yellow Terminals
DCT4-187D	.215 / .225 / .235 Hexes
DCT4-188D	.110 Hex
DCT4-189D	Comparable to MRP0478
DCT4-191D	Comparable to BURNDY MR8-9Q
DCT4-192D	Comparable to AMP 68064

Hydrac™ Hydraulic 3.5 Ton Crimping Tool for Y-Dies

HD37 Hydraulic Crimpers are a combination of lightweight design and the precise application of 3.5 tons force to crimp power contacts too large for conventional hand tools. These tools are designed to accept the entire family of M22520/5-XX dies (Y-dies) for crimping terminals, lugs or any other special applications. (DMC "Y" series dies featured on pages 71 and 77.

If your application requirement is not already covered by one of our standard dies, our engineering department will be pleased to discuss a design to suit your needs, consult DMC for details.

WIRE RANGE: #26 to #2 AWG in many power applications, and .500 (12.7mm) in coaxial hexagonal crimping.

HDE37B BATTERY POWERED HYDRAULIC CRIMP TOOL

The HDE37B Battery Powered Crimp Tool offers the portability of a hand tool with the stamina of a power tool! It is a hand held, self-contained hydraulic crimp tool that is actuated with a single squeeze of the trigger.

The HDE37B offers a solution where the volume of work exceeds the physical limits of a worker with hand tools, and hoses and cables are unwelcome or unsafe for the environment where the work is being performed.

The HDE37B battery tool is approximately 13.25" long, 2.87" wide, and 4.5" deep, weighs 2.8 lb with the battery installed.

TOOL INCLUDES: Carrying Case, Two 18v Batteries (p/n HDE-LI-B), One Battery Charger (p/n HDE-LI-120C).



FEATURES

- Ergonomic design allows one-handed operation
- Interchangeable die sets.
- Die automatically opens when crimp is complete
- Die can be retracted in mid-cycle to adjust connector
- Head rotates 350 degrees
- Red LED to display the current status of the unit



HD37 MANUAL TOOL

For the hand tool, the 3.5 ton crimp force is achieved through multiple actuations of the tool handle. The automatic relief valve "clicks" audibly when the proper crimp force has been applied to prevent over-compression. The tool head also rotates to any position for easy accessibility in confined working areas. The hand tool is 8.5 inches long, weighs only 3.3 lbs, and is operated with one hand.



- 3.5 tons of die force.
- Interchangeable die sets.
- Automatic relief valve to prevent over-compression
- Release lever for relaxing crimp pressure and opening dies mid-cycle
- 180° rotating head for ease in confined work areas.
- Each tool supplied in a fitted carrying case

LARGE GAGE INSULATED TERMINALS-MS25036

AWG SIZE	P/N	PART DIE P/N	CRIMP HEIGHT	GAGE
#8-RED	HD37 or HDE37B or EHCY	Y673H	0.17"	G682
#6-BLUE	HD37 or HDE37B or EHCY	Y674H	0.202"	G683

LARGE GAGE UNINSULATED TERMINALS-MS20659

AWG SIZE	P/N	PART DIE P/N	CRIMP HEIGHT	INDENT	GAGE
#8-RED	HD37 or HDE37B or EHCY	Y844HN	0.135"	SGL	G744
#8-RED	HD37 or HDE37B or EHCY	Y845HN	0.135"	DBL	G744
#6-BLUE	HD37 or HDE37B or EHCY	Y846HN	0.176"	SGL	G745
#6-BLUE	HD37 or HDE37B or EHCY	Y847HN	0.176"	DBL	G745

OTHER DIES

AWG SIZE	P/N	PART P/N	CRIMP HEIGHT	GAGE
0.202" Hex Crimp	HD37 or HDE37B or EHCY	Y870H	0.202"	G724



Hydrac™ Hydraulic 3.5 Ton Crimping Tool for HD36 Dies

HD36 MANUAL HYDRAULIC TOOL

HD36 Hydraulic Crimper is a combination of a lightweight design and the precise application of 3.5 tons force to crimp power contacts too large for conventional hand tools. This tool is designed to accept the entire family of D36 dies for crimping terminals, lugs or any other special applications.

The 3.5 ton crimp force is achieved through multiple actuations of the tool handle. The automatic relief valve “clicks” audibly when the proper crimp force has been applied to prevent over-compression. The tool head also rotates 360 degrees for easy accessibility in confined working areas. The hand tool is 8.5 inches long, weighs only 3.3 lbs, and is operated with one hand.

If your application requirement is not already covered by one of our standard dies, our engineering department will be pleased to discuss a design to suit your needs, consult DMC for details.

- 3.5 tons of die force.
- Interchangeable die sets.
- Automatic relief valve to prevent over-compression
- Release lever for relaxing crimp pressure and opening dies mid-cycle
- 180° rotating head for ease in confined work areas.
- Each tool supplied in a fitted carrying case



HD36 TOOL SERIES DIES

DIE SET P/N	“A” CRIMP HEIGHT	“A” LENGTH	“B” CRIMP HEIGHT	“B” LENGTH	TYPE/APPLICATION
HD36-101	.552-DIA.	0.180			Single Cavity Circular Corresponds To HUSKIE HD-58
HD36-102	.420-RAD.	0.180			Single Cavity Circular Corresponds To HUSKIE HD-34
HD36-103	0.530	0.365			Single Cavity Hex
HD36-104	.750-GAGE	0.225			Single Cavity Hex, Corresponds To HOMAC 840
HD36-105N	0.198	0.185			Single Cavity Hex
HD36-106N	0.222	0.185			Single Cavity Hex
HD36-107N	0.280	0.155			Single Cavity Hex
HD36-109	.520-GAGE	0.340			Single Cavity Hex, Corresponds To HOMAC 5/8
HD36-110N	0.530	0.344			Corresponds To T&B 683-53701-1
HD36-111N	.135-GAGE	0.312			#8 Non-Insulated Single Indent
HD36-112N	.176-GAGE	0.312			#6 Non-Insulated Single Indent
HD36-113N	.206-GAGE	0.344			#4 Non-Insulated Single Indent
HD36-114N	.265-GAGE	0.344			#2 Non-Insulated Single Indent
HD36-115N	0.226	0.110	0.169	0.110	Double Cavity Hex Corresponds To PEN-011-2, & PEN-011-3
HD36-116N	0.284	0.110	0.114	0.110	Double Cavity Hex Corresponds To PEN-011-1, & PEN-011-4
HD36-124	0.390	0.344			Single Cavity Hex
HD36-125	0.600	0.344			Single Cavity Hex
HD36-126	0.217	0.344			Single Cavity Hex
HD36-128	0.160	0.344			Single Cavity Hex
HD36-130	.130-GAGE	0.344			Single Indent for Flag Terminals
HD36-131	0.446	0.344			1/0 Non-Insulated Terminal Lug
HD36-132	0.487	0.344			2/0 Non-Insulated Terminal Lug
HD36-135	0.110	0.100			HDE36 GAGING DIE
HD36-136	.240 GAGE	0.375			#6 INSULATED (BLUE), Corresponds To AMP 1490598-1
HD36-137	.272 GAGE	0.375			#4 Insulated (YELLOW), Corresponds To AMP 1490599-1
HD36-138	.176 GAGE	0.202	0.111	0.202	Non-Insulated Single Indent
HD36-139	.204 GAGE	0.250			#8 Insulated (RED), Corresponds To AMP 1490597-1
HD36-142	.184 DIA.	0.344			Single Cavity Circular

Battery Powered Hydraulic 4 Ton Crimp Tool for HD36 Dies

HDE36B BATTERY POWERED HYDRAULIC CRIMP TOOL FOR HD36 DIES

The HDE36B Battery Powered Crimp Tool offers the portability of a hand tool with the stamina of a power tool! It is a hand held, self-contained, 4 ton hydraulic crimp tool that is actuated with a single squeeze of the trigger.

This tool is designed to accept the entire family of D36 dies for crimping terminals, lugs or any other special applications. WIRE RANGE: #8 to #0 AWG* in many power applications, and .750 (19.05mm) in coaxial hexagonal crimping.

The HDE36B offers a solution where the volume of work exceeds the physical limits of a worker with hand tools, and hoses and cables are unwelcome or unsafe for the environment where the work is being performed.

The HDE36B battery tool is approximately 13.25" long, 2.87" wide, and 4.5" deep, weighs 2.8 lb with the battery installed.

TOOL INCLUDES: Carrying Case, Two 18v Batteries (p/n HDE-LI-B), One Battery Charger (p/n HDE-LI-120C).

DIE SELECTION: The HD36 crimper will accommodate all crimp dies listed on page 109. Other applications may be covered by this tool. Consult DMC for details.

*Wire range will vary depending on wire and terminal/contact.



FEATURES

- Ergonomic design allows one-handed operation
- Die automatically opens when crimp is complete
- Die can be retracted in mid-cycle to adjust connector
- Head rotates 350 degrees
- Red LED to display the current status of the unit

CRIMP CAPACITIES

- Max. Crimp Force: 4 Tons (35.6 kN)
- Avg. Crimp Time: 3 seconds
- Avg. Crimps per Charge: 100

SPECIFICATIONS

- Length: 13.25" (356 mm)
- Width: 2.87" (72.9 mm)
- Depth: 4.5" (114.3 mm)
- Weight (with battery): 2.8 lb (1.3 kg)
- Sound Level: 75 db(A) at 1 meter
- Vibration: <8.2 ft/s² (2.5 m/s²)
- Hydraulic Oil: Shell Tellus® T-15

Electric Hydraulic 3.5 Ton Crimp Tool for HD36 Dies

A TOTALLY SELF-CONTAINED PORTABLE CRIMP SYSTEM FOR PRODUCTION

The EHCD36 is a fast cycling bench-top crimp tool designed to be lightweight and rugged. The versatile features of the EHCD36 make this a good choice where production and quality cannot be compromised.

This unit is small in overall size (10.0" H x 7.1" W x 19.1" L) and weighs approximately 27 pounds, but has ample die force power to do most jobs. The crimp cycle time is only two seconds.

Powered by 110VAC with standard power cord. Other power & cord setups available.

COMPATIBILITY WITH EXISTING CRIMP DIES

The EHCD36 is designed to accept the entire family of D36 dies for crimping terminals, lugs or any other special applications. WIRE RANGE: #8 to #0 AWG* in many power applications, and .750 (19.05mm) in coaxial hexagonal crimping. This affords total utilization of existing dies and total interchangeability with HD36 hand tool frame and HDE36B battery powered hydraulic crimp tool.

FULL CYCLE CONTROL

Full die closure is assured on every crimp. The internal cycle control network will not allow the tool to open until complete closure is attained. The cycle control can be overridden with the Emergency Stop button.

OPERATOR SAFETY FEATURES

An Emergency Stop button is located on top of the tool. Depressing this button releases the hydraulic pressure and allows the crimp dies to re-open.

A Foot Pedal is Available (P/N EHCFF)

When the foot pedal is plugged to the unit, it disables the front panel actuator.

DIE SELECTION: The HD36 crimper will accommodate all crimp dies listed on page 109. Other applications may be covered by this tool. Consult DMC for details.

*Wire range will vary depending on wire and terminal/contact.



Hydrac™ Hydraulic 5.5 Ton Crimping Tool for HD51 Dies

HD51 Medium Duty Hydraulic Crimper is the most popular hand operated hydraulic crimper. The HD51 is still lightweight at 4.6 pounds, but the 5.5 tons of die force and the larger die configuration extends the range of crimping capabilities to 2/0 AWG* conductors in many applications. The HD51 Hydraulic Crimper utilizes rugged construction, lightweight materials, and comfortable handle grips for the best ergonomic advantage. The number of handle closures required to complete the crimp is reduced by the larger and more efficient hydraulic pump system. Other features are the following:

- Length: 14 inches (356 mm)
- Weight 4.6 pounds (2.08kg)
- Crimp force: 5.5 tons (48.93kN)
- Automatic relief valve to prevent over-compression
- Release lever for relaxing crimp pressure and opening dies
- 180° rotating head for ease in confined work areas.
- WIRE RANGE: (#12 to #2/0 AWG in many power applications, and .700 (17.78mm) in coaxial hexagonal crimping.

XHD51 Remote Hydraulic Crimp Head is a preferred solution for high yield applications on production lines and maintenance rework centers. A pumping system provides the hydraulic power to the remote crimping head, and the crimp head can be mounted in a stationary position, or used as a hand-held tool. The recommended hydraulic pump is the versatile HPU11M air powered pump that is featured on page 116 of this catalog. Other specifications that apply to the XHD51 are the following:

- Length: 7.1 inches (180.3mm)
- Weight 3.85 pounds (1.74kg)
- Crimp force: 5.5 tons (48.93kN)

DMC1383 Tool Kit contains the HD51 hand tool and all the dies for crimping insulated and uninsulated terminals and splices size 8 through 2/0. This tool kit is contained in a metal case with foam inserts that have contoured tool cavities, laminated instruction sheets permanently attached on a ring binder, and contents charts identifying the location of each tool.

EHCD51 Contact DMC about Electric Hydraulic tooling for HD51 Dies.

WIRE RANGE: #12 to #2/0 AWG in many power applications, and .700 (17.78mm) in coaxial hexagonal crimping.



*Wire range will vary depending on wire and terminal/contact.

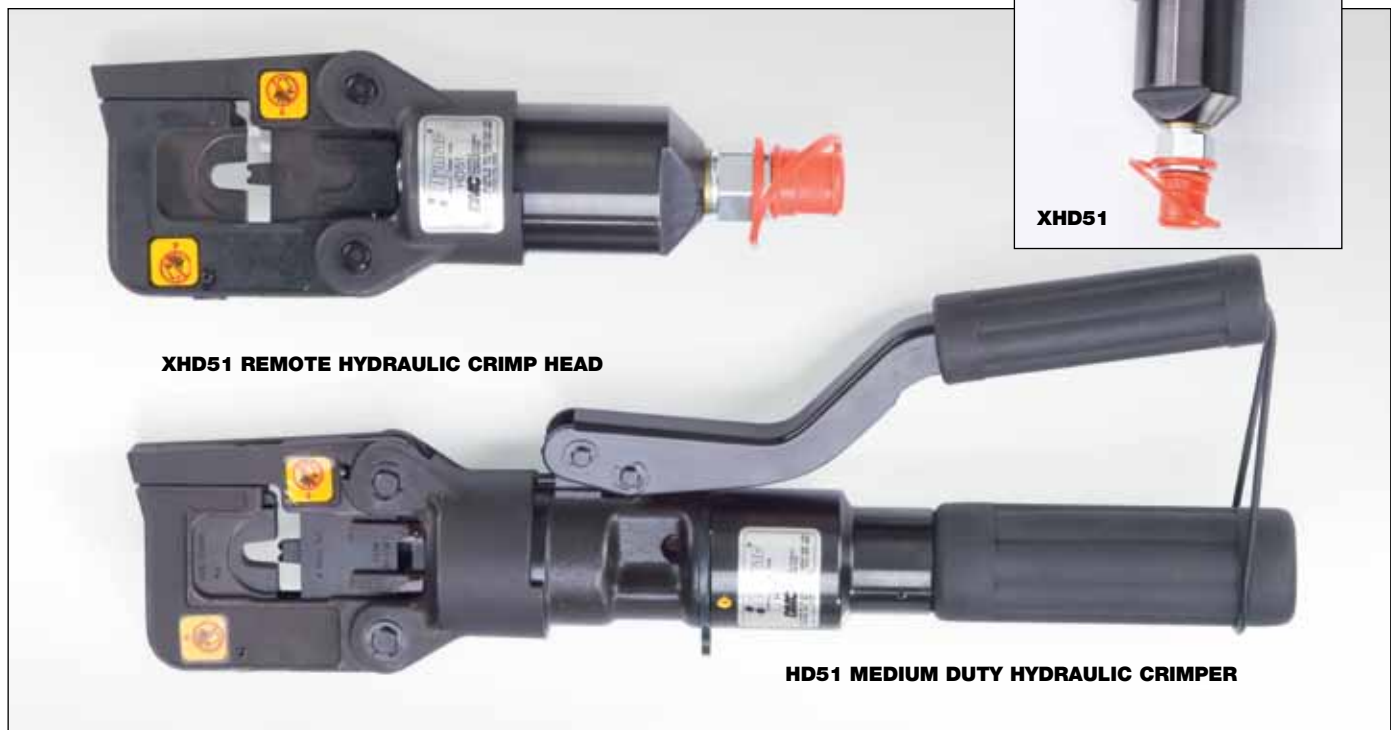

Hydrac™ HD51 Dies

HD51 TOOL SERIES DIES							
P/N	"A" CAVITY	"A" LENGTH	"B" CAVITY	"B" LENGTH	APPLICATION	INDENTS	GAGE
HD51-101	.325 HEX	.125	.216 HEX	.187	.325 / .216 Hexes		
HD51-105	.170 GAGE	.250			#8 Insulated Terminals		G682
HD51-106	.202 GAGE	.312			#6 Insulated Terminals		G683
HD51-107	.254 GAGE	.375			#4 Insulated Terminals		G684
HD51-110	.530 HEX	.365			.530 Hex		
HD51-112	.440 HEX	.358	.538 HEX	.358	.440 / .538 Hexes		
HD51-113	.312 GAGE	.470			#2 Insulated Terminals		G801
HD51-114N	.135 GAGE	.312			#8 Uninsulated Terminals	Single	G744
HD51-115N	.176 GAGE	.312			#6 Uninsulated Terminals	Single	G745
HD51-116N	.206 GAGE	.312			#4 Uninsulated Terminals	Single	G746
HD51-117N	.265 GAGE	.312			#2 Uninsulated Terminals	Single	G747
HD51-118N	.135 GAGE	.312			#8 Uninsulated Terminals	Double	G744
HD51-119N	.176 GAGE	.312			#6 Uninsulated Terminals	Double	G745
HD51-120N	.206 GAGE	.312			#4 Uninsulated Terminals	Double	G746
HD51-121N	.265 GAGE	.312			#2 Uninsulated Terminals	Double	G747
HD51-122N	.275 GAGE	.470			#1/0 Uninsulated Terminals	Single	G749
HD51-123N	.275 GAGE	.470			#1/0 Uninsulated Terminals	Double	G749
HD51-124N	.370 GAGE	.470			#2/0 Uninsulated Terminals	Double	G750
HD51-125N	.370 GAGE	.470			#2/0 Uninsulated Terminals	Single	G750
HD51-127	.445 HEX	.250	.395 HEX	.200	.445 / .395 Hexes		
HD51-128	.410 GAGE	.470			#1/0 Insulated Terminals		G854
HD51-129	.404 GAGE	.470			#2/0 Insulated Terminals		G855
HD51-130-1	R .100, H .300				#2 - #8 Uninsulated Needs HD51-131-2 or HD51-132-2	Single (MALE)	
HD51-131-2	R .275		R .145		#2 & #8 Uninsulated Needs HD51-130-1	Single (FEMALE)	G744 G747
HD51-132-2	R .219		R .188		#4 & #6 Uninsulated Needs HD51-130-1	Single (FEMALE)	G745 G746
HD51-133-2	.312 GAGE		.170 GAGE		#2 & #8 Insulated Needs HD51-113-1 for #2 & HD51-105-1 for #8	(FEMALE)	G801 (#2) G682 (#8)
HD51-134-2	.202 GAGE		.254 GAGE		#4 & #6 Insulated Needs HD51-106-1 for #6 & HD51-107-1 for #4	(FEMALE)	G683 (#6) G684 (#4)
HD51-138	.377 HEX	.435			#2 Uninsulated .377 Hex MS90485-2 Equiv.	MS90485-2 Equiv.	
HD51-139	.587 HEX	.400			.587 Hex		
HD51-140	.956 HEX		.500 HEX		.956 & .500 HEX		
HD51-144	.140 HEX	.470			.130 Hex		
HD51-148	.216 HEX				.216 Hex		
HD51-149	.660 HEX	.400			.660 Hex		
HD51-150	.352 HEX	.470			AB Twinax Pin & Socket Contacts		
HD51-152	.304 GAGE	.470			Packard Hughes .437 Ferrules		
HD51-154	.339 GAGE	.437			MS25036 #1 MS23002-1 Equiv.		G726
HD51-157					#10 Flag Terminal		
HD51-159	.312 GAGE	.470			#2 AWG Insulated	Elongated Hex	
HD51-160	.500 HEX	1.300			#2 Uninsulated For Aluminum Wire		
HD51-162	.218	.470			.218 HEX		

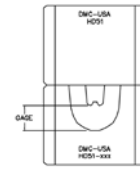
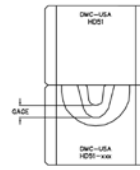
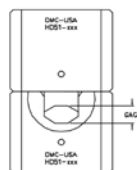
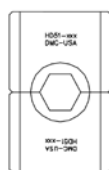

Hydrac™ Hydraulic 7 & 12 Ton Crimping Tools for HD002, HD485, and HD442 Dies (M5259)

HH80C Heavy Duty Hydraulic Crimper delivers the die force necessary to crimp large conductors, but still in a hand operated hydraulic crimper. The HH80C produces 7 tons with the two stage pump that minimizes the number of handle closures needed to complete the crimp. The utilization of the **HD002 (MS23002), HD485 (MS90485), and HD442 (MS25442) dies** extends the range of crimping capabilities to 2/0 AWG conductors in insulated military/aerospace applications and 4/0 AWG conductors in uninsulated military/aerospace applications. (Verification available upon request. Contact/terminal samples required.) **Boeing ST 2354 Series Dies are also available from DMC.** The HH80C Hydraulic Crimper is fitted with comfortable handle grips for the best ergonomic advantage.

Other features are the following:

- Crimp force: 7.0 tons (62.28kN)
- Length: 24 inches (610 mm)
- Weight 13.0 pounds (5.9kg)
- Automatic relief valve to prevent over-compression
- Release lever for relaxing crimp pressure and opening dies
- 360° rotating head for ease in confined work areas.
- Advance closing to crimp position is achieved by rotating the handle.



HH80C HEAVY DUTY HYDRAULIC CRIMPER

TBHD1M Remote Hydraulic Crimp Head (**MS25441-1**) exerts 12 tons of crimp force and extends the range of crimping capabilities to **4/0 AWG** conductors in military/aerospace applications, and 750 MCM applications on commercial systems. The **TBHD1M** accepts the **HD002 (MS23002), HD485 (MS90485), HD442 (MS25442)** and **Boeing ST 2354** Die combinations. In some cases the tool can be used as a hand-held crimper, but the tool weight (9.6 lbs) and force means mounting it in a stationary position with a bench mount (BM-2A) is the preferred mode of operation. The recommended hydraulic pump is the HPU11M air over hydraulic powered pump (see page 114) and consult DMC for other hydraulic pump options.

Other Specifications that apply to the TBHD1M are the following:

- Crimp force: 12.0 tons (107kN)
- Length: 10.0 inches (254 mm)
- Width: 6.0 inches (152.4 mm)
- Weight: 9.6 pounds (6.9 kg)



HD002 DIES



HD485 DIES



**MS25441-1 QUALIFIED TO M5259/1
(SHOWN WITHOUT SAFETY CAGE)**

MS23002* DIES & GAGES FOR MS25036 INSULATED TERMINALS

MIL DIE P/N *	DMC P/N	COMMENTS	MIL GAGE P/N *	DMC GAGE P/N
MS23002-8	HD002-8	For Insulated Size 8	MS23003-8	G723
MS23002-6	HD002-6	For Insulated Size 6	MS23003-6	G724
MS23002-4	HD002-4	For Insulated Size 4	MS23003-4	G725
MS23002-2	HD002-2	For Insulated Size 2	MS23003-2	G281
MS23002-1	HD002-1	For Insulated Size 1	MS23003-1	G726
MS23002-01	HD002-01	For Insulated Size 1/0	MS23003-01	G727
MS23002-02	HD002-02	For Insulated Size 2/0	MS23003-02	G728
MS23002-03	HD002-03	For Insulated Size 3/0	MS23003-03	G282
MS23002-04	HD002-04	For Insulated Size 4/0	MS23003-04	G729

MS90485* DIES & GAGES FOR MS20659 UNINSULATED COPPER TERMINALS

MIL DIE P/N*	DMC P/N	COMMENTS	MIL GAGE P/N *	DMC GAGE P/N
MS90485-8	HD485-8	For Uninsulated Size 8	MS90486-8	G720
MS90485-6	HD485-6	For Uninsulated Size 6	MS90486-6	G721
MS90485-4	HD485-4	For Uninsulated Size 4	MS90486-4	G722
MS90485-2	HD485-2	For Uninsulated Size 2	MS90486-2	G833
MS90485-1	HD485-1	For Uninsulated Size 1	MS90486-1	G834
MS90485-01	HD485-01	For Uninsulated Size 1/0	MS90486-01	G835
MS90485-02	HD485-02	For Uninsulated Size 2/0	MS90486-02	G836
MS90485-03	HD485-03	For Uninsulated Size 3/0	MS90486-03	G837
MS90485-04	HD485-04	For Uninsulated Size 4/0	MS90486-04	G838

MS25442* DIES & GAGES FOR AS70991 UNINSULATED ALUMINUM TERMINALS

MIL DIE P/N *	DMC P/N	COMMENTS	MIL GAGE P/N *	DMC GAGE P/N
MS25442-8A	HD442-8A	For Uninsulated Size 8	MS25472-1	G1129
MS25442-6A	HD442-6A	For Uninsulated Size 6	MS25472-2	G1130
MS25442-4A	HD442-4A	For Uninsulated Size 4	MS25472-3	G1131
MS25442-2A	HD442-2A	For Uninsulated Size 2	MS25472-4	G1132
MS25442-1A	HD442-1A	For Uninsulated Size 1	MS25472-5	G1133
MS25442-01A	HD442-01A	For Uninsulated Size 1/0	MS25472-6	G1134
MS25442-02A	HD442-02A	For Uninsulated Size 2/0	MS25472-7	G1135
MS25442-03A	HD442-03A	For Uninsulated Size 3/0	MS25472-8	G1136
MS25442-04A	HD442-04A	For Uninsulated Size 4/0	MS25472-9	G1137

DESCRIPTION	PART NO.	MIL DIE P/N *
Manual Hydraulic Tool (7 ton force)	HH80C	
Remote Crimp Head (12 ton force) (Requires Air to Hydraulic Pump)	TBHD1M *	MS25441-1 *
Air to Hydraulic Pump	HPU11M	
Hose Assembly (6 Ft. Length)	12-4040	MS25441-3*
In-Line Pressure Gauge	HPU11-PG	

***Qualified to M5259/1 Large Gage Crimp Tool Specification**

DMC1948 Tool Kit contains the TBHD1M Crimp Tool, HPU11M Pump, Hose Assembly, and all the HD002 (MS23002) and HD485 (MS90485) dies for crimping insulated and uninsulated terminals and splices size 8 through 4/0. This tool kit is contained in a molded, high-density plastic case with foam inserts that have contoured tool cavities, laminated instruction sheets permanently attached on a ring binder, and contents charts identifying the location of each tool.

DMC1966 Tool Kit contains the TBHD1M Crimp Tool, HPU11M Pump, Hose Assembly, and all the HD442 (MS25442) dies for crimping uninsulated aluminum terminals and splices size 8 through 4/0. This tool kit is contained in a molded, high-density plastic case with foam inserts that have contoured tool cavities, laminated instruction sheets permanently attached on a ring binder, and contents charts identifying the location of each tool.

HPU11-PG In-Line Hydraulic Pressure Gauge is recommended for cycle control monitoring, when using Remote Crimp Heads. It installs into either end of the hydraulic line to monitor the hydraulic pressure. The gauge will indicate to the operator when the required hydraulic pressure is achieved.

HC134 Dieless Four Indent Crimper

HPU11M AIR POWERED HYDRAULIC PUMP

HPU11M (MS25441-5) Air Powered Hydraulic Pump is the most economical and efficient way to provide controlled hydraulic pressure for XHD51 and TBHD1M remote crimp heads and similar applications. The use of light-weight materials and the latest air-over-hydraulic technology makes the **HPU11M** the best choice.

The **HPU11M** has heavy duty couplings and is intended to be used with the **12-4040** hydraulic hose assembly.



The specifications are the following:

- Maximum output pressure 10,000 PSI (Can be reduced by reducing input air pressure.)
- Depth: 11.5 inches
- Width: 13.75 inches
- Height: 6.25 Inches
- Weight: 19.4 pounds (with hose and hydraulic fluid)
- Hydraulic/air ratio is 100:1, input air pressure: 30–125 psi (2.1–8.6 bar)

HPU Series Pumps

We offer two portable manual pumps: a hand pump (p/n **HPU12M**) and a foot pump (p/n **HPU15M**). The other powered options are: an AC electric pump (p/n **HPU14M** & **HPU14M-230**) and a DC battery powered pump (p/n **HPU13M**). A heavy duty hose and couplings complete the connection between pump and crimper (p/n **12-4040**).

HPU11-PG In-Line Hydraulic Pressure Gauge is recommended for cycle control monitoring, when using Remote Crimp Heads.



HC134 DIELESS FOUR INDENT CRIMPER

HC134 Dieless Four-Indent Hydraulic Crimper is a four-indent crimper that can self adjust to the application. The tool provides a symmetrical four-sided crimp (at 90° intervals), and the crimp pressure against the resistance of the metal conductor assembly will cause the tool to crimp to a depth where there is metal to metal bottoming (gas tight crimp joint on aluminum and soft copper). Dies of a particular configuration are not needed.

The **HC134** produces 7 tons. The range of crimping capabilities starts with small conductors (around ¼ inch in diameter) to 4/0 AWG conductors on copper, and 750 MCM applications on aluminum.

Triangle indenter shape is standard. Optional indent designs are available. Consult DMC.

FEATURES

- Length: 24 inches (610 mm)
- Weight 13.0 pounds (5.9kg)
- Crimp force: 7.0 tons (62.28kN)
- Automatic relief valve to prevent over-compression
- Release lever for opening dies
- 360° rotating head for ease in confined work areas.
- Advance close by rotating handle.

DMC59 Utility Conductor Repair Kit (NSN 5180-01-220-1807)

A complete repair and service kit for aluminum and soft copper conductor maintenance. This tool kit contains the HC134 Crimper and a range of splices and high performance terminals (all two bolt type for high vibration), in a rugged metal box.



Wire Harness Tools

WIRE HARNESS SPOON

DMC's Wire Harness Spoon is used to assist in inserting new wires into existing wire harnesses. It helps thread new or repaired wires under tight cable ties, zip ties, string ties and cushion clamps.

The plastic construction of the wire harness spoon reduces damage when inserting wires because it will not damage ties or adjacent wires. There is less chance of nicks or cuts than with a metallic wire harness spoon. It can also be used to isolate cable ties for safe cutting to prevent damage to wire insulation.

The WHS-1 is Orange in color and .875" wide by 6" long.



CABLE TIE REMOVAL TOOLS

Now you can quickly remove cable ties without damaging the wire harness. The safety guards on the tip of the MG cable tie removal tools slide behind the cable tie strap to prevent the sharp blades from contacting and damaging the bundled items. The ergonomic, cushion grip handles and scissor action produce a clean cut.

Also use the MG series cable tie removal tools when repairing and retrofitting wire harnesses & hose assemblies, removing packaged items, prototyping & testing products, and many other factory and field uses.

These cable tie removal tools provide a long life when cutting plastic, thin copper wire, and aluminum wire AWG 10 & smaller. Each tool is made of heat treated alloy steel with a Rockwell hardness range of 53-58Rc.

PART NUMBER	CUTS CABLE TIE SIZES	TOOL LENGTH	TOOL WIDTH	DESCRIPTION
MG-1000	18 lb. to 250 lb.	5.80"	1.67"	Short Handle Length with Pointed Nose for Small Hands and Tight Spaces
MG-1100	18 lb. to 250 lb.	6.49"	2.35"	Standard Handle Length with Pointed Nose for Tight Spaces
MG-1200	18 lb. to 250 lb.	6.22"	2.63"	Standard Handle Length with Rounded Nose for Standard Use



Terminal and Splice Crimp Die Tooling Options 26 to 10 AWG

TOOLS AND DIES FOR CRIMPING TERMINALS AND SPLICES

DMC has several die configurations for crimping terminals and splices. AWG size is one determining factor, but each die configuration has a designated tool series. The hand tool is the basis of each tool series and suitable for the low volume of prototype or repair work. For higher volume production and

intermediate/depot maintenance, a tool series might include pneumatic tools, hydraulic tools, battery hydraulic tools, or electric hydraulic tools.

NOTE: If MIL Approval is required, QPL status should be verified. Consult DMC for current status.

26 to 10 AWG Tooling Options*

HX4 TOOL SERIES OPTIONS FOR Y-DIES



HX23
Pneumatic Tool, p. 74



HX4 or UDT4
Hand Tools, p. 70 & 75



HXE4B
Battery Hydraulic Tool, p. 72



EHCY
Electric/Hydraulic Tool, p. 76



HXE4-R
Battery Hydraulic Tool, p. 73

HX3 TOOL SERIES OPTIONS FOR X-DIES



HX3 or UDT3
Hand Tools, p. 70 & 75



PHX3
Pneumatic Tool, p. 75

GMT TOOL SERIES OPTIONS



GMTxxx
Hand Tool, p. 102



GMTExxx-R
Battery Hydraulic Tool, p. 105



GMTEBxxx
Battery Hydraulic Tool, p. 104

DCT TOOL SERIES OPTIONS



DCT4
Hand Tool, p. 106



DCTE4B
Battery Hydraulic Tool, p. 106

* Pneumatic or Hydraulic tool options preferred for 10-12 AWG Range.

Terminal and Splice Crimp Tooling Options 8 to 4/0 AWG

TOOLS AND DIES FOR CRIMPING TERMINALS AND SPLICES (CONTINUED)

8 to 4/0 AWG Tooling Options*

HX4 TOOL SERIES OPTIONS FOR Y-DIES



HD36 TOOL SERIES OPTIONS



HD51 TOOL SERIES OPTIONS**



TOOL OPTIONS FOR HD002, HD485, & HD442 DIES **



** Hydraulic pump, hose, and other accessories are shown elsewhere in the catalog.

WIRE STRIPPING FOR TERMINALS AND SPLICES

Wire strip length and configuration is important to the success of a termination. Guidelines for particular components being terminated should be followed carefully. For additional information on stripping wire for terminals and splices, contact DMC.

STANDARDIZATION

DMC has maintained a leadership role in military and commercial standards committees such as SAE, WHMA, EIA, UL/NEMA, and DoD organizations. The following tool selection charts represent the current leading standard components and tools. If questions or conflicts arise in the use of these charts, please notify DMC (407-855-6161, DMC@DMCTools.com).



Similar Terminal Shown

M7928/1-1 to -10, Sizes 26 to 24

TYPE: Class 1 Insulated Terminals, Insulation Restricting
INSULATION: Nylon, UL 94V-2
TERMINAL BODY & SLEEVE: Copper, ASTM B-152
PLATING: Nickel, QQ-N-290, or Tin, ASTM B-545
MAX TEMP RATING: 105° C

Tool Selection Guide*

TERMINAL SPECS					DMC TOOL/DIE OPTIONS					
AWG	WIRE SIZE MM	INSULATION DIAMETER IN. (MM)	SLEEVE COLOR	TERMINAL/SPLICE PART NUMBER	HX4 SERIES MIL APPROVED*	HX3 SERIES MIL APPROVED*	MIL APPROVED* TOOL	HX4 SERIES SINGLE CAVITY	HX4 SERIES MULTI CAVITY	
#26	0.15	.026-.055 (0.66-1.40)	Yellow w/ Black Stripe	M7928/1-	1	Y501 Die	X511 Die	M22520/40-01	Y672 Die	Y1060 Die
					2	Y501 Die	X511 Die	M22520/40-01	Y672 Die	Y1060 Die
					3	Y501 Die	X511 Die	M22520/40-01	Y672 Die	Y1060 Die
					4	Y501 Die	X511 Die	M22520/40-01	Y672 Die	Y1060 Die
					5	Y501 Die	X511 Die	M22520/40-01	Y672 Die	Y1060 Die
#24	0.24	.031-.055 (0.79-1.40)	Yellow w/ Blue Stripe	M7928/1-	6	Y501 Die	X511 Die	M22520/40-01	Y672 Die	Y1060 Die
					7	Y501 Die	X511 Die	M22520/40-01	Y672 Die	Y1060 Die
					8	Y501 Die	X511 Die	M22520/40-01	Y672 Die	Y1060 Die
					9	Y501 Die	X511 Die	M22520/40-01	Y672 Die	Y1060 Die
					10	Y501 Die	X511 Die	M22520/40-01	Y672 Die	Y1060 Die

* If MIL Approval is required, QPL status should be verified. Consult DMC for current status.

Terminal Manufacturers' Part Numbers

TERMINAL SPECS			TERMINAL MANUFACTURERS' TERMINAL #						
AWG	SLEEVE COLOR	TERMINAL/SPLICE PART NUMBER	BURNDY	HOLLINGSWORTH	MOLEX	PANDUIT	THOMAS&BETTS	TYCO ELEC	
#26	Yellow w/ Black Stripe	M7928/1-	1	--	--	--	--	--	53078
			2	--	--	--	--	--	53049
			3	--	--	--	--	--	53050
			4	--	--	--	--	--	53051
			5	--	--	--	--	--	53052
#24	Yellow w/ Blue Stripe	M7928/1-	6	--	--	--	--	--	53053
			7	--	--	--	--	--	53054
			8	--	--	--	--	--	53055
			9	--	--	--	--	--	53056
			10	--	--	--	--	--	53057

NOTE: Component manufactures' and OEM instructions shall take precedence over the information presented in these charts. Wire ranges are for reference only.

HX4 TOOL SERIES OPTIONS FOR Y-DIES

HX4 Hand Tools, p. 70 & 75
 HXE4B, HXE4-R Battery Tools, p. 72 & 73
 HX23 Pneumatic Tool, p. 74
 EHCY Electric Hydraulic Tool, p. 76

HX3 TOOL SERIES OPTIONS FOR X-DIES

HX3 Hand Tools, p. 70 & 75
 PHX3 Pneumatic Tool, p. 75

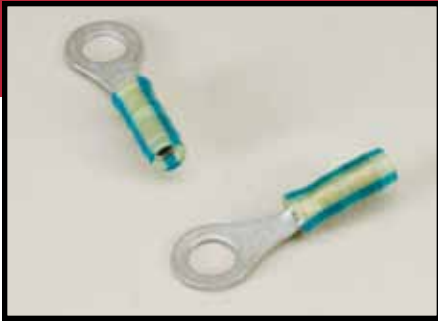

Similar Terminal Shown

M7928/1-11 to -19, Size 22

TYPE: Class 1 Insulated Terminals, Insulation Restricting
INSULATION: Nylon, UL 94V-2
TERMINAL BODY & SLEEVE: Copper, ASTM B-152
PLATING: Copper, ASTM B-152
MAX TEMP RATING: 105° C

Tool Selection Guide*

TERMINAL SPECS					DMC TOOL/DIE OPTIONS					
AWG	WIRE SIZE MM	INSULATION DIAMETER IN. (MM)	SLEEVE COLOR	TERMINAL/SPLICE PART NUMBER	HX4 SERIES MIL APPROVED*	HX3 SERIES MIL APPROVED*	MIL APPROVED* TOOL	HX4 SERIES SINGLE CAVITY	HX4 SERIES MULTI CAVITY	
#22	0.38	.038-.110 (0.97-2.79)	Red w/ Green Stripe	M7928/1-	11	Y501 Die	X511 Die	M22520/40-01	Y672 Die	Y1060 Die
					12	Y501 Die	X511 Die	M22520/40-01	Y672 Die	Y1060 Die
					13	Y501 Die	X511 Die	M22520/40-01	Y672 Die	Y1060 Die
					14	Y501 Die	X511 Die	M22520/40-01	Y672 Die	Y1060 Die
					15	Y501 Die	X511 Die	M22520/40-01	Y672 Die	Y1060 Die
					16	Y501 Die	X511 Die	M22520/40-01	Y672 Die	Y1060 Die
					17	Y501 Die	X511 Die	M22520/40-01	Y672 Die	Y1060 Die
					18	Y501 Die	X511 Die	M22520/40-01	Y672 Die	Y1060 Die
					19	Y501 Die	X511 Die	M22520/40-01	Y672 Die	Y1060 Die

* If MIL Approval is required, QPL status should be verified. Consult DMC for current status.

Terminal Manufacturers' Part Numbers

TERMINAL SPECS			TERMINAL MANUFACTURERS' TERMINAL #						
AWG	SLEEVE COLOR	TERMINAL/SPLICE PART NUMBER	BURNDY	HOLLINGSWORTH	MOLEX	PANDUIT	THOMAS&BETTS	TYCO ELEC	
#22	Red w/ Green Stripe	M7928/1-	11	--	--	--	--	--	52273
			12	--	--	--	--	--	2-36149-3
			13	--	--	--	--	--	51863-2
			14	--	--	--	--	--	1-320551-2
			15	--	--	--	--	--	2-36153-3
			16	--	--	--	--	--	2-320571-3
			17	--	--	--	--	--	2-320572-2
			18	--	--	--	--	--	2-320573-1
			19	--	--	--	--	--	2-328975-1

NOTE: Component manufactures' and OEM instructions shall take precedence over the information presented in these charts. Wire ranges are for reference only.

HX4 TOOL SERIES OPTIONS FOR Y-DIES

HX4 Hand Tools, p. 70 & 75
 HXE4B, HXE4-R Battery Tools, p. 72 & 73
 HX23 Pneumatic Tool, p. 74
 EHCY Electric Hydraulic Tool, p. 76

HX3 TOOL SERIES OPTIONS FOR X-DIES

HX3 Hand Tools, p. 70 & 75
 PHX3 Pneumatic Tool, p. 75



Similar Terminal Shown

M7928/1-20 to -28, Size 20

TYPE: Class 1 Insulated Terminals, Insulation Restricting
INSULATION: Nylon, UL 94V-2
TERMINAL BODY & SLEEVE: Copper, ASTM B-152
PLATING: Nickel, QQ-N-290, or Tin, ASTM B-545
MAX TEMP RATING: 105° C

Tool Selection Guide*

TERMINAL SPECS					DMC TOOL/DIE OPTIONS					
AWG	WIRE SIZE MM	INSULATION DIAMETER IN. (MM)	SLEEVE COLOR	TERMINAL/SPLICE PART NUMBER	HX4 SERIES MIL APPROVED*	HX3 SERIES MIL APPROVED*	MIL APPROVED* TOOL	HX4 SERIES SINGLE CAVITY	HX4 SERIES MULTI CAVITY	
#20	0.60	.046-.110 (1.17-2.79)	Red w/ Red Stripe	M7928/1-	20	Y501 Die	X511 Die	M22520/40-01	Y672 Die	Y1060 Die
					21	Y501 Die	X511 Die	M22520/40-01	Y672 Die	Y1060 Die
					22	Y501 Die	X511 Die	M22520/40-01	Y672 Die	Y1060 Die
					23	Y501 Die	X511 Die	M22520/40-01	Y672 Die	Y1060 Die
					24	Y501 Die	X511 Die	M22520/40-01	Y672 Die	Y1060 Die
					25	Y501 Die	X511 Die	M22520/40-01	Y672 Die	Y1060 Die
					26	Y501 Die	X511 Die	M22520/40-01	Y672 Die	Y1060 Die
					27	Y501 Die	X511 Die	M22520/40-01	Y672 Die	Y1060 Die
					28	Y501 Die	X511 Die	M22520/40-01	Y672 Die	Y1060 Die

* If MIL Approval is required, QPL status should be verified. Consult DMC for current status.

Terminal Manufacturers' Part Numbers

TERMINAL SPECS			TERMINAL MANUFACTURERS' TERMINAL #						
AWG	SLEEVE COLOR	TERMINAL/SPLICE PART NUMBER	BURNDY	HOLLINGSWORTH	MOLEX	PANDUIT	THOMAS&BETTS	TYCO ELEC	
#20	Red w/ Red Stripe	M7928/1-	20	--	--	--	--	--	52273-1
			21	--	--	--	--	--	2-36149-4
			22	--	--	--	--	--	51863-3
			23	--	--	--	--	--	1-320551-3
			24	--	--	--	--	--	2-36153-4
			25	--	--	--	--	--	2-320571-4
			26	--	--	--	--	--	2-320572-3
			27	--	--	--	--	--	2-320573-2
			28	--	--	--	--	--	2-328975-2

NOTE: Component manufactures' and OEM instructions shall take precedence over the information presented in these charts. Wire ranges are for reference only.

HX4 TOOL SERIES OPTIONS FOR Y-DIES

HX4 Hand Tools, p. 70 & 75
 HXE4B, HXE4-R Battery Tools, p. 72 & 73
 HX23 Pneumatic Tool, p. 74
 EHCY Electric Hydraulic Tool, p. 76

HX3 TOOL SERIES OPTIONS FOR X-DIES

HX3 Hand Tools, p. 70 & 75
 PHX3 Pneumatic Tool, p. 75



Similar Terminal Shown

M7928/1-29 to -37, Size 18

TYPE: Class 1 Insulated Terminals, Insulation Restricting
INSULATION: Nylon, UL 94V-2
TERMINAL BODY & SLEEVE: Copper, ASTM B-152
PLATING: Nickel, QQ-N-290, or Tin, ASTM B-545
MAX TEMP RATING: 105° C

Tool Selection Guide*

TERMINAL SPECS					DMC TOOL/DIE OPTIONS					
AWG	WIRE SIZE MM	INSULATION DIAMETER IN. (MM)	SLEEVE COLOR	TERMINAL/SPLICE PART NUMBER	HX4 SERIES MIL APPROVED*	HX3 SERIES MIL APPROVED*	MIL APPROVED* TOOL	HX4 SERIES SINGLE CAVITY	HX4 SERIES MULTI CAVITY	
#18	0.96	.056-.110 (1.42-2.79)	Red w/ White Stripe	M7928/1-	29	Y501 Die	X511 Die	M22520/40-01	Y672 Die	Y1060 Die
					30	Y501 Die	X511 Die	M22520/40-01	Y672 Die	Y1060 Die
					31	Y501 Die	X511 Die	M22520/40-01	Y672 Die	Y1060 Die
					32	Y501 Die	X511 Die	M22520/40-01	Y672 Die	Y1060 Die
					33	Y501 Die	X511 Die	M22520/40-01	Y672 Die	Y1060 Die
					34	Y501 Die	X511 Die	M22520/40-01	Y672 Die	Y1060 Die
					35	Y501 Die	X511 Die	M22520/40-01	Y672 Die	Y1060 Die
					36	Y501 Die	X511 Die	M22520/40-01	Y672 Die	Y1060 Die
					37	Y501 Die	X511 Die	M22520/40-01	Y672 Die	Y1060 Die

* If MIL Approval is required, QPL status should be verified. Consult DMC for current status.

Terminal Manufacturers' Part Numbers

TERMINAL SPECS				TERMINAL MANUFACTURERS' TERMINAL #					
AWG	SLEEVE COLOR	TERMINAL/SPLICE PART NUMBER		BURNDY	HOLLINGSWORTH	MOLEX	PANDUIT	THOMAS&BETTS	TYCO ELEC
#18	Red w/ White Stripe	M7928/1-	29	--	--	--	--	--	52273-2
			30	--	--	--	--	--	2-36149-5
			31	--	--	--	--	--	51863-4
			32	--	--	--	--	--	1-320551-4
			33	--	--	--	--	--	2-36153-5
			34	--	--	--	--	--	2-320571-5
			35	--	--	--	--	--	2-320572-4
			36	--	--	--	--	--	2-320573-3
			37	--	--	--	--	--	2-328975-3

NOTE: Component manufactures' and OEM instructions shall take precedence over the information presented in these charts. Wire ranges are for reference only.

HX4 TOOL SERIES OPTIONS FOR Y-DIES

HX4 Hand Tools, p. 70 & 75
 HXE4B, HXE4-R Battery Tools, p. 72 & 73
 HX23 Pneumatic Tool, p. 74
 EHCY Electric Hydraulic Tool, p. 76

HX3 TOOL SERIES OPTIONS FOR X-DIES

HX3 Hand Tools, p. 70 & 75
 PHX3 Pneumatic Tool, p. 75



Similar Terminal Shown

M7928/1-38 to -46, Size 16

TYPE: Class 1 Insulated Terminals, Insulation Restricting
INSULATION: Nylon, UL 94V-2
TERMINAL BODY & SLEEVE: Copper, ASTM B-152
PLATING: Nickel, QQ-N-290, or Tin, ASTM B-545
MAX TEMP RATING: 105° C

Tool Selection Guide*

TERMINAL SPECS				DMC TOOL/DIE OPTIONS						
AWG	WIRE SIZE MM	INSULATION DIAMETER IN. (MM)	SLEEVE COLOR	TERMINAL/SPLICE PART NUMBER	HX4 SERIES MIL APPROVED*	HX3 SERIES MIL APPROVED*	MIL APPROVED* TOOL	HX4 SERIES SINGLE CAVITY	HX4 SERIES MULTI CAVITY	
#16	1.42	.063-.130 (1.60-3.30)	Blue w/ Blue Stripe	M7928/1-	38	Y501 Die	X511 Die	M22520/40-01	Y671 Die	Y1060 Die
					39	Y501 Die	X511 Die	M22520/40-01	Y671 Die	Y1060 Die
					40	Y501 Die	X511 Die	M22520/40-01	Y671 Die	Y1060 Die
					41	Y501 Die	X511 Die	M22520/40-01	Y671 Die	Y1060 Die
					42	Y501 Die	X511 Die	M22520/40-01	Y671 Die	Y1060 Die
					43	Y501 Die	X511 Die	M22520/40-01	Y671 Die	Y1060 Die
					44	Y501 Die	X511 Die	M22520/40-01	Y671 Die	Y1060 Die
					45	Y501 Die	X511 Die	M22520/40-01	Y671 Die	Y1060 Die
					46	Y501 Die	X511 Die	M22520/40-01	Y671 Die	Y1060 Die

* If MIL Approval is required, QPL status should be verified. Consult DMC for current status.

Terminal Manufacturers' Part Numbers

TERMINAL SPECS			TERMINAL MANUFACTURERS' TERMINAL #						
AWG	SLEEVE COLOR	TERMINAL/SPLICE PART NUMBER	BURNDY	HOLLINGSWORTH	MOLEX	PANDUIT	THOMAS&BETTS	TYCO ELEC	
#16	Blue w/ Blue Stripe	M7928/1-	38	--	--	--	--	--	52274
			39	--	--	--	--	--	2-320561-3
			40	--	--	--	--	--	51864-6
			41	--	--	--	--	--	1-51864-0
			42	--	--	--	--	--	51864-7
			43	--	--	--	--	--	2-320563-3
			44	--	--	--	--	--	2-320575-2
			45	--	--	--	--	--	2-320564-1
			46	--	--	--	--	--	2-328976-1

NOTE: Component manufactures' and OEM instructions shall take precedence over the information presented in these charts. Wire ranges are for reference only.

HX4 TOOL SERIES OPTIONS FOR Y-DIES

HX4 Hand Tools, p. 70 & 75
 HXE4B, HXE4-R Battery Tools, p. 72 & 73
 HX23 Pneumatic Tool, p. 74
 EHCY Electric Hydraulic Tool, p. 76

HX3 TOOL SERIES OPTIONS FOR X-DIES

HX3 Hand Tools, p. 70 & 75
 PHX3 Pneumatic Tool, p. 75



Similar Terminal Shown

M7928/1-47 to -55, Size 14

TYPE: Class 1 Insulated Terminals, Insulation Restricting
INSULATION: Nylon, UL 94V-2
TERMINAL BODY & SLEEVE: Copper, ASTM B-152
PLATING: Nickel, QQ-N-290, or Tin, ASTM B-545
MAX TEMP RATING: 105° C

Tool Selection Guide*

TERMINAL SPECS					DMC TOOL/DIE OPTIONS					
AWG	WIRE SIZE MM	INSULATION DIAMETER IN. (MM)	SLEEVE COLOR	TERMINAL/SPLICE PART NUMBER	HX4 SERIES MIL APPROVED*	HX3 SERIES MIL APPROVED*	MIL APPROVED* TOOL	HX4 SERIES SINGLE CAVITY	HX4 SERIES MULTI CAVITY	
#14	2.15	.078-.130 (1.98-3.30)	Blue w/ Green Stripe	M7928/1-	47	Y501 Die	X511 Die	M22520/40-01	Y671 Die	Y1060 Die
					48	Y501 Die	X511 Die	M22520/40-01	Y671 Die	Y1060 Die
					49	Y501 Die	X511 Die	M22520/40-01	Y671 Die	Y1060 Die
					50	Y501 Die	X511 Die	M22520/40-01	Y671 Die	Y1060 Die
					51	Y501 Die	X511 Die	M22520/40-01	Y671 Die	Y1060 Die
					52	Y501 Die	X511 Die	M22520/40-01	Y671 Die	Y1060 Die
					53	Y501 Die	X511 Die	M22520/40-01	Y671 Die	Y1060 Die
					54	Y501 Die	X511 Die	M22520/40-01	Y671 Die	Y1060 Die
					55	Y501 Die	X511 Die	M22520/40-01	Y671 Die	Y1060 Die

* If MIL Approval is required, QPL status should be verified. Consult DMC for current status.

Terminal Manufacturers' Part Numbers

TERMINAL SPECS			TERMINAL MANUFACTURERS' TERMINAL #						
AWG	SLEEVE COLOR	TERMINAL/SPLICE PART NUMBER	BURNDY	HOLLINGSWORTH	MOLEX	PANDUIT	THOMAS&BETTS	TYCO ELEC	
#14	Blue w/ Green Stripe	M7928/1-	47	--	--	--	--	--	52274-1
			48	--	--	--	--	--	2-320561-4
			49	--	--	--	--	--	51864-8
			50	--	--	--	--	--	1-51864-1
			51	--	--	--	--	--	51864-9
			52	--	--	--	--	--	2-320563-4
			53	--	--	--	--	--	2-320575-3
			54	--	--	--	--	--	2-320564-2
			55	--	--	--	--	--	2-328976-2

NOTE: Component manufactures' and OEM instructions shall take precedence over the information presented in these charts. Wire ranges are for reference only.

HX4 TOOL SERIES OPTIONS FOR Y-DIES

HX4 Hand Tools, p. 70 & 75
 HXE4B, HXE4-R Battery Tools, p. 72 & 73
 HX23 Pneumatic Tool, p. 74
 EHCY Electric Hydraulic Tool, p. 76

HX3 TOOL SERIES OPTIONS FOR X-DIES

HX3 Hand Tools, p. 70 & 75
 PHX3 Pneumatic Tool, p. 75



Similar Terminal Shown

M7928/1-56 to -62, Size 12

TYPE: Class 1 Insulated Terminals, Insulation Restricting
INSULATION: Nylon, UL 94V-2
TERMINAL BODY & SLEEVE: Copper, ASTM B-152
PLATING: Nickel, QQ-N-290, or Tin, ASTM B-545
MAX TEMP RATING: 105° C

Tool Selection Guide*

TERMINAL SPECS					DMC TOOL/DIE OPTIONS			
AWG	WIRE SIZE MM	INSULATION DIAMETER IN. (MM)	SLEEVE COLOR	TERMINAL/SPLICE PART NUMBER	HX4 SERIES MIL APPROVED*	HX3 SERIES MIL APPROVED*	HX4 SERIES SINGLE CAVITY	
#12	3.37	.095-.200 (2.41-5.08)	Yellow w/ Yellow Stripe	M7928/1-	56	Y501 Die	X515 Die	Y670 Die
					57	Y501 Die	X515 Die	Y670 Die
					58	Y501 Die	X515 Die	Y670 Die
					59	Y501 Die	X515 Die	Y670 Die
					60	Y501 Die	X515 Die	Y670 Die
					61	Y501 Die	X515 Die	Y670 Die
					62	Y501 Die	X515 Die	Y670 Die

* If MIL Approval is required, QPL status should be verified. Consult DMC for current status.

Terminal Manufacturers' Part Numbers

TERMINAL SPECS			TERMINAL MANUFACTURERS' TERMINAL #						
AWG	SLEEVE COLOR	TERMINAL/SPLICE PART NUMBER	BURNDY	HOLLINGSWORTH	MOLEX	PANDUIT	THOMAS&BETTS	TYCO ELEC	
#12	Yellow w/ Yellow Stripe	M7928/1-	56	--	--	--	--	--	2-36161-5
			57	--	--	--	--	--	2-320568-2
			58	--	--	--	--	--	2-36161-3
			59	--	--	--	--	--	2-320569-5
			60	--	--	--	--	--	2-320576-2
			61	--	--	--	--	--	2-320577-1
			62	--	--	--	--	--	--

NOTE: Component manufactures' and OEM instructions shall take precedence over the information presented in these charts. Wire ranges are for reference only.

HX4 TOOL SERIES OPTIONS FOR Y-DIES

HX4 Hand Tools, p. 70 & 75
 HXE4B, HXE4-R Battery Tools, p. 72 & 73
 HX23 Pneumatic Tool, p. 74
 EHCY Electric Hydraulic Tool, p. 76

HX3 TOOL SERIES OPTIONS FOR X-DIES

HX3 Hand Tools, p. 70 & 75
 PHX3 Pneumatic Tool, p. 75



Similar Terminal Shown

M7928/1-63 to -69, Size 10

TYPE: Class 1 Insulated Terminals, Insulation Restricting
INSULATION: Nylon, UL 94V-2
TERMINAL BODY & SLEEVE: Copper, ASTM B-152
PLATING: Nickel, QQ-N-290, or Tin, ASTM B-545
MAX TEMP RATING: 105° C

Tool Selection Guide*

TERMINAL SPECS					DMC TOOL/DIE OPTIONS				
AWG	WIRE SIZE MM	INSULATION DIAMETER IN. (MM)	SLEEVE COLOR	TERMINAL/SPLICE PART NUMBER	HX4 SERIES MIL APPROVED*	HX3 SERIES MIL APPROVED*	HX4 SERIES SINGLE CAVITY		
#10	6.11	.119-.200 (3.02-5.08)	Yellow w/ Brown Stripe	M7928/1-	63	Y501 Die	X515 Die	Y670 Die	
					64	Y501 Die	X515 Die	Y670 Die	
					65	Y501 Die	X515 Die	Y670 Die	
					66	Y501 Die	X515 Die	Y670 Die	
					67	Y501 Die	X515 Die	Y670 Die	
					68	Y501 Die	X515 Die	Y670 Die	
					69	Y501 Die	X515 Die	Y670 Die	

* If MIL Approval is required, QPL status should be verified. Consult DMC for current status.

Terminal Manufacturers' Part Numbers

TERMINAL SPECS			TERMINAL MANUFACTURERS' TERMINAL #						
AWG	SLEEVE COLOR	TERMINAL/SPLICE PART NUMBER	BURNDY	HOLLINGSWORTH	MOLEX	PANDUIT	THOMAS&BETTS	TYCO ELEC	
#10	Yellow w/ Brown Stripe	M7928/1-	63	--	--	--	--	--	2-36161-6
			64	--	--	--	--	--	2-320568-3
			65	--	--	--	--	--	2-36161-4
			66	--	--	--	--	--	2-320569-6
			67	--	--	--	--	--	2-320576-3
			68	--	--	--	--	--	2-320577-2
			69	--	--	--	--	--	--

NOTE: Component manufactures' and OEM instructions shall take precedence over the information presented in these charts. Wire ranges are for reference only.

HX4 TOOL SERIES OPTIONS FOR Y-DIES

HX4 Hand Tools, p. 70 & 75
 HXE4B, HXE4-R Battery Tools, p. 72 & 73
 HX23 Pneumatic Tool, p. 74
 EHCY Electric Hydraulic Tool, p. 76

HX3 TOOL SERIES OPTIONS FOR X-DIES

HX3 Hand Tools, p. 70 & 75
 PHX3 Pneumatic Tool, p. 75



Similar Terminal Shown

M7928/4-101 to -110, Sizes 22 to 14

TYPE: Class 1 Insulated Terminals, Radiation Resistant
INSULATION: Polyvinylidene flouride (PVF2)
TERMINAL BODY & SLEEVE: Copper, ASTM B-152
PLATING: Tin, ASTM B-545
MAX TEMP RATING: 150° C

Tool Selection Guide*

TERMINAL SPECS					DMC TOOL/DIE OPTIONS					
AWG	WIRE SIZE MM	INSULATION DIAMETER IN. (MM)	SLEEVE COLOR	TERMINAL/SPLICE PART NUMBER	HX4 SERIES MIL APPROVED*	HX3 SERIES MIL APPROVED*	MIL APPROVED* TOOL	HX4 SERIES SINGLE CAVITY	HX4 SERIES MULTI CAVITY	
#22-18	0.26-0.96	.140 (3.56)	Red	M7928/4-	101	Y501 Die	X511 Die	M22520/40-01	Y672 Die	Y1060 Die
					102	Y501 Die	X511 Die	M22520/40-01	Y672 Die	Y1060 Die
					103	Y501 Die	X511 Die	M22520/40-01	Y672 Die	Y1060 Die
					104	Y501 Die	X511 Die	M22520/40-01	Y672 Die	Y1060 Die
					105	Y501 Die	X511 Die	M22520/40-01	Y672 Die	Y1060 Die
#16-14	1.04 - 2.62	.170 (4.32)	Blue	M7928/4-	106	Y501 Die	X511 Die	M22520/40-01	Y671 Die	Y1060 Die
					107	Y501 Die	X511 Die	M22520/40-01	Y671 Die	Y1060 Die
					108	Y501 Die	X511 Die	M22520/40-01	Y671 Die	Y1060 Die
					109	Y501 Die	X511 Die	M22520/40-01	Y671 Die	Y1060 Die
					110	Y501 Die	X511 Die	M22520/40-01	Y671 Die	Y1060 Die

* If MIL Approval is required, QPL status should be verified. Consult DMC for current status.

Terminal Manufacturers' Part Numbers

TERMINAL SPECS			TERMINAL MANUFACTURERS' TERMINAL #						
AWG	SLEEVE COLOR	TERMINAL/SPLICE PART NUMBER	BURNDY	HOLLINGSWORTH	MOLEX	PANDUIT	THOMAS&BETTS	TYCO ELEC	
#22-18	Red	M7928/4-	101	--	--	--	--	--	53406-1
			102	--	--	--	--	--	53407-1
			103	--	--	--	--	--	53409-1
			104	--	--	--	--	--	53411-1
			105	--	--	--	--	--	53412-1
#16-14	Blue	M7928/4-	106	--	--	--	--	--	53415-1
			107	--	--	--	--	--	53416-1
			108	--	--	--	--	--	53418-1
			109	--	--	--	--	--	53420-1
			110	--	--	--	--	--	53421-1

NOTE: Component manufactures' and OEM instructions shall take precedence over the information presented in these charts. Wire ranges are for reference only.

HX4 TOOL SERIES OPTIONS FOR Y-DIES

HX4 Hand Tools, p. 70 & 75
 HXE4B, HXE4-R Battery Tools, p. 72 & 73
 HX23 Pneumatic Tool, p. 74
 EHCY Electric Hydraulic Tool, p. 76

HX3 TOOL SERIES OPTIONS FOR X-DIES

HX3 Hand Tools, p. 70 & 75
 PHX3 Pneumatic Tool, p. 75

M7928/4-111 to -114, Sizes 12 to 10



Similar Terminal Shown

TYPE: Class 1 Insulated Terminals, Radiation Resistant
INSULATION: Polyvinylidene flouride (PVF2)
TERMINAL BODY & SLEEVE: Copper, ASTM B-152
PLATING: Tin, ASTM B-545
MAX TEMP RATING: 150° C

Tool Selection Guide*

TERMINAL SPECS					DMC TOOL/DIE OPTIONS				
AWG	WIRE SIZE MM	INSULATION DIAMETER IN. (MM)	SLEEVE COLOR	TERMINAL/SPLICE PART NUMBER	HX4 SERIES MIL APPROVED*	HX3 SERIES MIL APPROVED*	HX4 SERIES SINGLE CAVITY		
#12-10	2.62 - 6.64	.230 (5.84)	Yellow	M7928/4-	111	Y501 Die	X515 Die	Y670 Die	
					112	Y501 Die	X515 Die	Y670 Die	
					113	Y501 Die	X515 Die	Y670 Die	
					114	Y501 Die	X515 Die	Y670 Die	

* If MIL Approval is required, QPL status should be verified. Consult DMC for current status.

Terminal Manufacturers' Part Numbers

TERMINAL SPECS			TERMINAL MANUFACTURERS' TERMINAL #						
AWG	SLEEVE COLOR	TERMINAL/SPLICE PART NUMBER	BURNDY	HOLLINGSWORTH	MOLEX	PANDUIT	THOMAS&BETTS	TYCO ELEC	
#12-10	Yellow	M7928/4-	111	--	--	--	--	--	53423-1
			112	--	--	--	--	--	53425-1
			113	--	--	--	--	--	53427-1
			114	--	--	--	--	--	53428-1

NOTE: Component manufactures' and OEM instructions shall take precedence over the information presented in these charts. Wire ranges are for reference only.

HX4 TOOL SERIES OPTIONS FOR Y-DIES

HX4 Hand Tools, p. 70 & 75
 HXE4B, HXE4-R Battery Tools, p. 72 & 73
 HX23 Pneumatic Tool, p. 74
 EHCY Electric Hydraulic Tool, p. 76

HX3 TOOL SERIES OPTIONS FOR X-DIES

HX3 Hand Tools, p. 70 & 75
 PHX3 Pneumatic Tool, p. 75



Similar Terminal Shown

M7928/4-143 to -151, Sizes 26 to 18

TYPE: Class 1 Insulated Terminals, Radiation Resistant
INSULATION: Polyvinylidene flouride (PVF2)
TERMINAL BODY & SLEEVE: Copper, ASTM B-152
PLATING: Tin, ASTM B-545
MAX TEMP RATING: 150° C

Tool Selection Guide*

TERMINAL SPECS					DMC TOOL/DIE OPTIONS					
AWG	WIRE SIZE MM	INSULATION DIAMETER IN. (MM)	SLEEVE COLOR	TERMINAL/SPLICE PART NUMBER	HX4 SERIES MIL APPROVED*	HX3 SERIES MIL APPROVED*	MIL APPROVED* TOOL	HX4 SERIES SINGLE CAVITY	HX4 SERIES MULTI CAVITY	
#26-24	0.10 - 0.26	.082 (2.09)	Yellow	M7928/4-	143	Y501 Die	X511 Die	M22520/40-01	Y672 Die	Y1060 Die
					144	Y501 Die	X511 Die	M22520/40-01	Y672 Die	Y1060 Die
					145	Y501 Die	X511 Die	M22520/40-01	Y672 Die	Y1060 Die
					146	Y501 Die	X511 Die	M22520/40-01	Y672 Die	Y1060 Die
					147	Y501 Die	X511 Die	M22520/40-01	Y672 Die	Y1060 Die
#22-18	0.26 - 0.96	.125 (3.18)	Red	M7928/4-	148	Y501 Die	X511 Die	M22520/40-01	Y672 Die	Y1060 Die
					149	Y501 Die	X511 Die	M22520/40-01	Y672 Die	Y1060 Die
					150	Y501 Die	X511 Die	M22520/40-01	Y672 Die	Y1060 Die
					151	Y501 Die	X511 Die	M22520/40-01	Y672 Die	Y1060 Die

* If MIL Approval is required, QPL status should be verified. Consult DMC for current status.

Terminal Manufacturers' Part Numbers

TERMINAL SPECS			TERMINAL MANUFACTURERS' TERMINAL #						
AWG	SLEEVE COLOR	TERMINAL/SPLICE PART NUMBER	BURNDY	HOLLINGSWORTH	MOLEX	PANDUIT	THOMAS&BETTS	TYCO ELEC	
#26-24	Yellow	M7928/4-	143	--	--	--	--	--	53400-1
			144	--	--	--	--	--	53401-1
			145	--	--	--	--	--	53402-1
			146	--	--	--	--	--	53403-1
			147	--	--	--	--	--	53404-1
#22-18	Red	M7928/4-	148	--	--	--	--	--	53405-1
			149	--	--	--	--	--	53408-1
			150	--	--	--	--	--	53410-1
			151	--	--	--	--	--	53413-1

NOTE: Component manufactures' and OEM instructions shall take precedence over the information presented in these charts. Wire ranges are for reference only.

HX4 TOOL SERIES OPTIONS FOR Y-DIES

HX4 Hand Tools, p. 70 & 75
 HXE4B, HXE4-R Battery Tools, p. 72 & 73
 HX23 Pneumatic Tool, p. 74
 EHCY Electric Hydraulic Tool, p. 76

HX3 TOOL SERIES OPTIONS FOR X-DIES

HX3 Hand Tools, p. 70 & 75
 PHX3 Pneumatic Tool, p. 75



Similar Terminal Shown

M7928/4-152 TO -159, SIZES 16 TO 10

TYPE: Class 1 Insulated Terminals, Radiation Resistant
INSULATION: Polyvinylidene flouride (PVF2)
TERMINAL BODY & SLEEVE: Copper, ASTM B-152
PLATING: Tin, ASTM B-545
MAX TEMP RATING: 150° C

Tool Selection Guide*

TERMINAL SPECS					DMC TOOL/DIE OPTIONS					
AWG	WIRE SIZE MM	INSULATION DIAMETER IN. (MM)	SLEEVE COLOR	TERMINAL/SPLICE PART NUMBER	HX4 SERIES MIL APPROVED*	HX3 SERIES MIL APPROVED*	MIL APPROVED* TOOL	HX4 SERIES SINGLE CAVITY	HX4 SERIES MULTI CAVITY	
#16-14	1.04 - 2.62	.150 (3.81)	Blue	M7928/4-	152	Y501 Die	X511 Die	M22520/40-01	Y671 Die	Y1060 Die
					153	Y501 Die	X511 Die	M22520/40-01	Y671 Die	Y1060 Die
					154	Y501 Die	X511 Die	M22520/40-01	Y671 Die	Y1060 Die
					155	Y501 Die	X511 Die	M22520/40-01	Y671 Die	Y1060 Die
#12-10	2.62 - 6.64	.230 (5.84)	Yellow	M7928/4-	156	Y501 Die	X515 Die	--	Y670 Die	--
					157	Y501 Die	X515 Die	--	Y670 Die	--
					158	Y501 Die	X515 Die	--	Y670 Die	--
					159	Y501 Die	X515 Die	--	Y670 Die	--

* If MIL Approval is required, QPL status should be verified. Consult DMC for current status.

Terminal Manufacturers' Part Numbers

TERMINAL SPECS			TERMINAL MANUFACTURERS' TERMINAL #						
AWG	SLEEVE COLOR	TERMINAL/SPLICE PART NUMBER	BURNDY	HOLLINGSWORTH	MOLEX	PANDUIT	THOMAS&BETTS	TYCO ELEC	
#16-14	Blue	M7928/4-	152	--	--	--	--	--	53414-1
			153	--	--	--	--	--	53417-1
			154	--	--	--	--	--	53419-1
			155	--	--	--	--	--	53422-1
#12-10	Yellow	M7928/4-	156	--	--	--	--	--	53424-1
			157	--	--	--	--	--	53426-1
			158	--	--	--	--	--	--
			159	--	--	--	--	--	--

NOTE: Component manufactures' and OEM instructions shall take precedence over the information presented in these charts. Wire ranges are for reference only.

HX4 TOOL SERIES OPTIONS FOR Y-DIES

HX4 Hand Tools, p. 70 & 75
 HXE4B, HXE4-R Battery Tools, p. 72 & 73
 HX23 Pneumatic Tool, p. 74
 EHCY Electric Hydraulic Tool, p. 76

HX3 TOOL SERIES OPTIONS FOR X-DIES

HX3 Hand Tools, p. 70 & 75
 PHX3 Pneumatic Tool, p. 75



Similar Splice Shown

M7928/5-1 TO -5, SIZES 26 TO 10

TYPE: Class 1 Insulated Splices
INSULATION: Nylon, UL 94V-2
TERMINAL BODY & SLEEVE: Copper, ASTM B-152
PLATING: Nickel, QQ-N-290, or Tin, ASTM B-545
MAX TEMP RATING: 105° C

Tool Selection Guide*

SPLICE SPECS					DMC TOOL/DIE OPTIONS		
AWG	WIRE SIZE MM	INSULATION DIAMETER IN. (MM)	SLEEVE COLOR	TERMINAL/SPLICE PART NUMBER		HX4 SERIES MIL APPROVED*	MIL APPROVED* TOOL
#26-24	0.12-0.24	.082 (2.08)	Yellow	M7928/5-	1	Y527 Die	M22520/40-01
#24 -20	0.16-0.65	.100 (2.54)	Natural	M7928/5-	2	Y527 Die	M22520/40-01
#22-18	0.26-0.96	.125 (3.18)	Red	M7928/5-	3	Y501 Die	M22520/40-01
#16-14	1.04-2.62	.150 (3.81)	Blue	M7928/5-	4	Y539 Die	M22520/40-01
#12-10	2.62-6.64	.220 (5.59)	Yellow	M7928/5-	5	Y501 Die	--

* If MIL Approval is required, QPL status should be verified. Consult DMC for current status.

Splice Manufacturers' Part Numbers

SPLICE SPECS				SPLICE MANUFACTURERS' SPLICE #					
AWG	SLEEVE COLOR	TERMINAL/SPLICE PART NUMBER		BURNDY	HOLLINGSWORTH	MOLEX	PANDUIT	THOMAS&BETTS	TYCO ELEC (RAYCHEM)
#26-24	Yellow	M7928/5-	1	--	--	--	--	--	323994
#24 -20	Natural	M7928/5-	2	--	--	--	--	--	323975
#22-18	Red	M7928/5-	3	--	B18 70BN	--	WA-840	--	320559
#16-14	Blue	M7928/5-	4	--	B18 71BN	--	WB-841	--	320562
#12-10	Yellow	M7928/5-	5	--	B18 72BN	--	WC-842	--	320570

NOTE: Component manufactures' and OEM instructions shall take precedence over the information presented in these charts. Wire ranges are for reference only.

HX4 TOOL SERIES OPTIONS FOR Y-DIES

HX4 Hand Tools, p. 70 & 75
 HXE4B, HXE4-R Battery Tools, p. 72 & 73
 HX23 Pneumatic Tool, p. 74
 EHCY Electric Hydraulic Tool, p. 76



Similar Splice Shown

M7928/6-1 TO -5, SIZES 26 TO 10

TYPE: Class 1 Insulated Splices, Radiation Resistant
INSULATION: Polyninyldene flouride (PVF2) [Natural Color]
SPLICE BODY & SLEEVE: Copper, ASTM B-152
PLATING: Tin, ASTM B-545
MAX TEMP RATING: 105° C

Tool Selection Guide*

SPLICE SPECS					DMC TOOL/DIE OPTIONS		
AWG	WIRE SIZE MM	INSULATION DIAMETER IN. (MM)	SLEEVE COLOR	TERMINAL/SPLICE PART NUMBER		HX4 SERIES MIL APPROVED*	MIL APPROVED* TOOL
#26-24	0.12-0.24	.082 (2.08)	Yellow Stripe	M7928/6-	1	Y527 Die	M22520/40-01
#24 -20	0.16-0.65	.100 (2.54)	White Stripe	M7928/6-	2	Y527 Die	M22520/40-01
#22-18	0.26-0.96	.125 (3.18)	Red Stripe	M7928/6-	3	Y501 Die	M22520/40-01
#16-14	1.04-2.62	.150 (3.81)	Blue Stripe	M7928/6-	4	Y539 Die	M22520/40-01
#12-10	2.62-6.64	.220 (5.59)	Yellow Stripe	M7928/6-	5	Y501 Die	--

* If MIL Approval is required, QPL status should be verified. Consult DMC for current status.

Splice Manufacturers' Part Numbers

SPLICE SPECS				SPLICE MANUFACTURERS' SPLICE #					
AWG	SLEEVE COLOR	TERMINAL/SPLICE PART NUMBER		BURNDY	HOLLINGSWORTH	MOLEX	PANDUIT	THOMAS&BETTS	TYCO ELEC (RAYCHEM)
#26-24	Yellow Stripe	M7928/6-	1	--	--	--	--	--	53546-1
#24 -20	White Stripe	M7928/6-	2	--	--	--	--	--	53547-1
#22-18	Red Stripe	M7928/6-	3	--	--	--	--	--	53548-1
#16-14	Blue Stripe	M7928/6-	4	--	--	--	--	--	53549-1
#12-10	Yellow Stripe	M7928/6-	5	--	--	--	--	--	53550-1

NOTE: Component manufactures' and OEM instructions shall take precedence over the information presented in these charts. Wire ranges are for reference only.

HX4 TOOL SERIES OPTIONS FOR Y-DIES

HX4 Hand Tools, p. 70 & 75
 HXE4B, HXE4-R Battery Tools, p. 72 & 73
 HX23 Pneumatic Tool, p. 74
 EHCY Electric Hydraulic Tool, p. 76



Similar Terminal Shown

M7928/7-1 TO -11, SIZES 22 TO 14

TYPE: Class 1 Uninsulated Terminals, Ring Tongue
INSULATION: N/A
TERMINAL BODY & SLEEVE: Copper, ASTM B-152
PLATING: Tin, ASTM B-545
MAX TEMP RATING: 175° C

Tool Selection Guide*

TERMINAL SPECS					DMC TOOL/DIE OPTIONS					
AWG	WIRE SIZE MM	INSULATION DIAMETER IN. (MM)	SLEEVE COLOR	TERMINAL/SPLICE PART NUMBER	HX4 SERIES MULTI CAVITY (1 INDENT)	HX4 SERIES MULTI CAVITY (2 INDENTS)	GMT SERIES TOOL (1 INDENT)	GMT SERIES TOOL (2 INDENTS)	DCT4 SERIES	
#22-18	0.26-0.96	N/A	N/A	M7928/7-	1	Y554 Die	Y788 Die	GMT277	GMT1005	DCT4-105D Die
					2	Y554 Die	Y788 Die	GMT277	GMT1005	DCT4-105D Die
					3	Y554 Die	Y788 Die	GMT277	GMT1005	DCT4-105D Die
					4	Y554 Die	Y788 Die	GMT277	GMT1005	DCT4-105D Die
					5	Y554 Die	Y788 Die	GMT277	GMT1005	DCT4-105D Die
					6	Y554 Die	Y788 Die	GMT277	GMT1005	DCT4-105D Die
#16-14	1.04 - 2.62	N/A	N/A	M7928/7-	7	Y554 Die	Y788 Die	GMT277	GMT1005	DCT4-105D Die
					8	Y554 Die	Y788 Die	GMT277	GMT1005	DCT4-105D Die
					9	Y554 Die	Y788 Die	GMT277	GMT1005	DCT4-105D Die
					10	Y554 Die	Y788 Die	GMT277	GMT1005	DCT4-105D Die
					11	Y554 Die	Y788 Die	GMT277	GMT1005	DCT4-105D Die

* If MIL Approval is required, QPL status should be verified. Consult DMC for current status.

Terminal Manufacturers' Part Numbers

TERMINAL SPECS			TERMINAL MANUFACTURERS' TERMINAL #						
AWG	SLEEVE COLOR	TERMINAL/SPLICE PART NUMBER	BURNDY	HOLLINGSWORTH	MOLEX	PANDUIT	THOMAS&BETTS	TYCO ELEC	
#22-18	N/A	M7928/7-	1	--	R4103B	--	--	--	--
			2	--	R4104B	--	--	--	--
			3	--	R4262B	--	--	--	--
			4	--	R4264B	--	--	--	--
			5	--	R4114B	--	--	--	--
			6	--	R4115B	--	--	--	--
#16-14	N/A	M7928/7-	7	--	R4121B	--	--	--	--
			8	--	R4123B	--	--	--	320093
			9	--	R4125B	--	--	--	--
			10	--	R4126B	--	--	--	--
			11	--	R4119B	--	--	--	--

NOTE: Component manufactures' and OEM instructions shall take precedence over the information presented in these charts. Wire ranges are for reference only.

GMT TOOL SERIES OPTIONS

GMTxxx Hand Tool, p. 102
 GMTEBxxx Battery Tool, p. 104
 GMTExxx-R Battery Tool, p. 105

HX4 TOOL SERIES OPTIONS FOR Y-DIES

HX4 Hand Tools, p. 70 & 75
 HXE4B, HXE4-R Battery Tools, p. 72 & 73
 HX23 Pneumatic Tool, p. 74
 EHCY Electric Hydraulic Tool, p. 76

DCT TOOL SERIES OPTIONS

DCT4 Hand Tool, p. 106
 DCTE4B Battery Tool, p. 106



Similar Splice Shown

M81824/1-01 TO -03, SIZES 26 TO 12

TYPE: Class 1 Insulated Splices

INSULATION: Heat Shrinkable Transparent Polyvinylidene Flouride

SPLICE BODY & SLEEVE: Copper, WW-T-775 or ASTM B75-68
or QQ-C-502 or QQ-C-578

PLATING: Tin

SEALING MATERIAL: Modified Thermoplastic

MAX TEMP RATING: 150° C

Tool Selection Guide*

SPLICE SPECS						DMC TOOL/DIE OPTIONS			
AWG	WIRE SIZE MM	MULTIPLE CONDUCTORS CMA RANGE	SLEEVE COLOR	TERMINAL/SPLICE PART NUMBER		GMT SERIES MIL* APPROVED	HX4 SERIES MIL* APPROVED	HX3 SERIES MIL* APPROVED	HX4 SERIES DIE
#26-20	0.15-0.61	304 - 1510	Red	M81824/1-	01	GMT232	Y540 Die	X528 Die	Y516 Die
#20-16	0.39-1.34	779 - 2680	Blue	M81824/1-	02	GMT232	Y540 Die	X528 Die	Y516 Die
#16-12	0.95-3.37	1900 - 6755	Yellow	M81824/1-	03	GMT232	Y539 Die	X527 Die	Y516 Die

* If MIL Approval is required, QPL status should be verified. Consult DMC for current status.

Splice Manufacturers' Part Numbers

SPLICE SPECS				SPLICE MANUFACTURERS' SPLICE #						
AWG	SLEEVE COLOR	TERMINAL/SPLICE PART NUMBER		BURNDY	HOLLINGSWORTH	MOLEX	PANDUIT	TRI-STAR ELECTRONICS	TYCO ELEC (RAYCHEM)	SUMITOMO
#26-20	Red	M81824/1-	01	--	--	--	--	H-C2005T	D-436-36	H-CR-436-36
#20-16	Blue	M81824/1-	02	--	--	--	--	H-C1605T	D-436-37	H-CR-436-37
#16-12	Yellow	M81824/1-	03	--	--	--	--	H-C1205T	D-436-38	H-CR-436-38

NOTE: Component manufactures' and OEM instructions shall take precedence over the information presented in these charts. Wire ranges are for reference only.

GMT TOOL SERIES OPTIONS

GMTxxx Hand Tool, p. 102
GMTEBxxx Battery Tool, p. 104
GMTExxx-R Battery Tool, p. 105

HX4 TOOL SERIES OPTIONS FOR Y-DIES

HX4 Hand Tools, p. 70 & 75
HXE4B, HXE4-R Battery Tools, p. 72 & 73
HX23 Pneumatic Tool, p. 74
EHCY Electric Hydraulic Tool, p. 76

HX3 TOOL SERIES OPTIONS FOR X-DIES

HX3 Hand Tools, p. 70 & 75
PHX3 Pneumatic Tool, p. 75



Similar Splice Shown

M81824/6-01 to -03, Sizes 26 to 12

TYPE: Class 1 Insulated Splices

INSULATION: Heat Shrinkable Polyvinylidene Flouride

SPLICE BODY & SLEEVE: Copper, ASTM B-280 or B75-68 or B152

PLATING: Tin, ASTM B-545

SEALING MATERIAL: Modified Thermoplastic

MAX TEMP RATING: 150° C

Tool Selection Guide*

SPLICE SPECS						DMC TOOL/DIE OPTIONS			
AWG	WIRE SIZE MM	MULTIPLE CONDUCTORS CMA RANGE	SLEEVE COLOR	TERMINAL/SPLICE PART NUMBER		GMT SERIES MIL* APPROVED	HX4 SERIES MIL* APPROVED	HX3 SERIES MIL* APPROVED	HX4 SERIES DIE
#26-20	0.15-0.61	304 - 1510	Red	M81824/6-	01	GMT232	Y540 Die	X528 Die	Y516 Die
#20-16	0.39-1.34	779 - 2680	Blue	M81824/6-	02	GMT232	Y540 Die	X528 Die	Y516 Die
#16-12	0.95-3.37	1900 - 6755	Yellow	M81824/6-	03	GMT232	Y539 Die	X527 Die	Y516 Die

* If MIL Approval is required, QPL status should be verified. Consult DMC for current status.

Splice Manufacturers' Part Numbers

SPLICE SPECS				SPLICE MANUFACTURERS' SPLICE #						
AWG	SLEEVE COLOR	TERMINAL/SPLICE PART NUMBER		BURNDY	HOLLINGSWORTH	MOLEX	PANDUIT	THOMAS & BETTS	TYCO ELEC (RAYCHEM)	SUMITOMO
#26-20	Red	M81824/6-	01	--	--	--	--	--	D-436-82	--
#20-16	Blue	M81824/6-	02	--	--	--	--	--	D-436-83	--
#16-12	Yellow	M81824/6-	03	--	--	--	--	--	D-436-84	--

NOTE: Component manufactures' and OEM instructions shall take precedence over the information presented in these charts. Wire ranges are for reference only.

GMT TOOL SERIES OPTIONS

GMTxxx Hand Tool, p. 102
 GMTEBxxx Battery Tool, p. 104
 GMTExxx-R Battery Tool, p. 105

HX4 TOOL SERIES OPTIONS FOR Y-DIES

HX4 Hand Tools, p. 70 & 75
 HXE4B, HXE4-R Battery Tools, p. 72 & 73
 HX23 Pneumatic Tool, p. 74
 EHCY Electric Hydraulic Tool, p. 76

HX3 TOOL SERIES OPTIONS FOR X-DIES

HX3 Hand Tools, p. 70 & 75
 PHX3 Pneumatic Tool, p. 75



Similar Splice Shown

M81824/7-01 TO -03, SIZES 26 TO 12

TYPE: Class 1 Insulated Splices
INSULATION: Heat Shrinkable Polyvinylidene Flouride
SPLICE BODY & SLEEVE: Copper, ASTM B-280 or B75-68 or B152
PLATING: Tin, ASTM B-545
SEALING MATERIAL: Modified Thermoplastic
MAX TEMP RATING: 150° C

Tool Selection Guide*

SPLICE SPECS					DMC TOOL/DIE OPTIONS			
AWG	WIRE SIZE MM	MULTIPLE CONDUCTORS CMA RANGE	SLEEVE COLOR	TERMINAL/SPLICE PART NUMBER	GMT SERIES MIL* APPROVED	HX4 SERIES MIL* APPROVED	HX3 SERIES MIL* APPROVED	HX4 SERIES DIE
#26-20	0.15-0.61	304 - 1510	Red	M81824/7-01	GMT232	Y540 Die	X528 Die	Y516 Die
#20-16	0.39-1.34	779 - 2680	Blue	M81824/7-02	GMT232	Y540 Die	X528 Die	Y516 Die
#16-12	0.95-3.37	1900 - 6755	Yellow	M81824/7-03	GMT232	Y539 Die	X527 Die	Y516 Die

* If MIL Approval is required, QPL status should be verified. Consult DMC for current status.

Splice Manufacturers' Part Numbers

SPLICE SPECS				SPLICE MANUFACTURERS' SPLICE #						
AWG	SLEEVE COLOR	TERMINAL/SPLICE PART NUMBER		BURNDY	HOLLINGSWORTH	MOLEX	PANDUIT	THOMAS & BETTS	TYCO ELEC (RAYCHEM)	SUMITOMO
#26-20	Red	M81824/7-	01	--	--	--	--	--	D-436-0110	--
#20-16	Blue	M81824/7-	02	--	--	--	--	--	D-436-52	--
#16-12	Yellow	M81824/7-	03	--	--	--	--	--	D-436-53	--

NOTE: Component manufactures' and OEM instructions shall take precedence over the information presented in these charts. Wire ranges are for reference only.

GMT TOOL SERIES OPTIONS

GMTxxx Hand Tool, p. 102
 GMTEBxxx Battery Tool, p. 104
 GMTExxx-R Battery Tool, p. 105

HX4 TOOL SERIES OPTIONS FOR Y-DIES

HX4 Hand Tools, p. 70 & 75
 HXE4B, HXE4-R Battery Tools, p. 72 & 73
 HX23 Pneumatic Tool, p. 74
 EHCY Electric Hydraulic Tool, p. 76

HX3 TOOL SERIES OPTIONS FOR X-DIES

HX3 Hand Tools, p. 70 & 75
 PHX3 Pneumatic Tool, p. 75

M81824/8-01 TO -03, SIZES 26 TO 12



Similar Splice Shown

TYPE: Class 1 Insulated Splices
INSULATION: Heat Shrinkable Polyvinylidene Flouride
SPLICE BODY & SLEEVE: Copper, ASTM B-280 or B75-68 or B152
PLATING: Nickel, SAE AMS-QQ-N290
SEALING MATERIAL: Modified Thermoplastic
MAX TEMP RATING: 175° C

Tool Selection Guide*

SPLICE SPECS						DMC TOOL/DIE OPTIONS			
AWG	WIRE SIZE MM	MULTIPLE CONDUCTORS CMA RANGE	SLEEVE COLOR	TERMINAL/SPLICE PART NUMBER		GMT SERIES MIL* APPROVED	HX4 SERIES MIL* APPROVED	HX3 SERIES MIL* APPROVED	HX4 SERIES DIE
#26-20	0.15-0.61	304 - 1510	Red	M81824/8-	01	GMT232	Y540 Die	X528 Die	Y516 Die
#20-16	0.39-1.34	779 - 2680	Blue	M81824/8-	02	GMT232	Y540 Die	X528 Die	Y516 Die
#16-12	0.95-3.37	1900 - 6755	Yellow	M81824/8-	03	GMT232	Y539 Die	X527 Die	Y516 Die

* If MIL Approval is required, QPL status should be verified. Consult DMC for current status.

Splice Manufacturers' Part Numbers

SPLICE SPECS				SPLICE MANUFACTURERS' SPLICE #						
AWG	SLEEVE COLOR	TERMINAL/SPLICE PART NUMBER		BURNDY	HOLLINGSWORTH	MOLEX	PANDUIT	THOMAS & BETTS	TYCO ELEC (RAYCHEM)	SUMITOMO
#26-20	Red	M81824/8-	01	--	--	--	--	--	D-436-85	--
#20-16	Blue	M81824/8-	02	--	--	--	--	--	D-436-86	--
#16-12	Yellow	M81824/8-	03	--	--	--	--	--	D-436-87	--

NOTE: Component manufactures' and OEM instructions shall take precedence over the information presented in these charts. Wire ranges are for reference only.

GMT TOOL SERIES OPTIONS

GMTxxx Hand Tool, p. 102
 GMTEBxxx Battery Tool, p. 104
 GMTExxx-R Battery Tool, p. 105

HX4 TOOL SERIES OPTIONS FOR Y-DIES

HX4 Hand Tools, p. 70 & 75
 HXE4B, HXE4-R Battery Tools, p. 72 & 73
 HX23 Pneumatic Tool, p. 74
 EHCY Electric Hydraulic Tool, p. 76

HX3 TOOL SERIES OPTIONS FOR X-DIES

HX3 Hand Tools, p. 70 & 75
 PHX3 Pneumatic Tool, p. 75



Similar Splice Shown

M81824/9-01 TO -03, SIZES 26 TO 12

TYPE: Class 1 Insulated Splices
INSULATION: Heat Shrinkable Polyvinylidene Flouride
SPLICE BODY & SLEEVE: Copper, ASTM B-280 or B75-68 or B152
PLATING: Tin, ASTM B-545
SEALING MATERIAL: Modified Thermoplastic
MAX TEMP RATING: 150° C

Tool Selection Guide*

SPLICE SPECS						DMC TOOL/DIE OPTIONS			
AWG	WIRE SIZE MM	MULTIPLE CONDUCTORS CMA RANGE	SLEEVE COLOR	TERMINAL/SPLICE PART NUMBER		GMT SERIES MIL* APPROVED	HX4 SERIES MIL* APPROVED	HX3 SERIES MIL*APPROVED	HX4 SERIES DIE
#26-20	0.15-0.61	304 - 1510	Red	M81824/9-	01	GMT232	Y540 Die	X528 Die	Y516 Die
#20-16	0.39-1.34	779 - 2680	Blue	M81824/9-	02	GMT232	Y540 Die	X528 Die	Y516 Die
#16-12	0.95-3.37	1900 - 6755	Yellow	M81824/9-	03	GMT232	Y539 Die	X527 Die	Y516 Die

* If MIL Approval is required, QPL status should be verified. Consult DMC for current status.

Splice Manufacturers' Part Numbers

SPLICE SPECS				SPLICE MANUFACTURERS' SPLICE #						
AWG	SLEEVE COLOR	TERMINAL/SPLICE PART NUMBER		BURNDY	HOLLINGSWORTH	MOLEX	PANDUIT	THOMAS & BETTS	TYCO ELEC (RAYCHEM)	SUMITOMO
#26-20	Red	M81824/9-	01	--	--	--	--	--	D-436-0115	--
#20-16	Blue	M81824/9-	02	--	--	--	--	--	D-436-42	--
#16-12	Yellow	M81824/9-	03	--	--	--	--	--	D-436-43	--

NOTE: Component manufactures' and OEM instructions shall take precedence over the information presented in these charts. Wire ranges are for reference only.

GMT TOOL SERIES OPTIONS

GMTxxx Hand Tool, p. 102
 GMTEBxxx Battery Tool, p. 104
 GMTExxx-R Battery Tool, p. 105

HX4 TOOL SERIES OPTIONS FOR Y-DIES

HX4 Hand Tools, p. 70 & 75
 HXE4B, HXE4-R Battery Tools, p. 72 & 73
 HX23 Pneumatic Tool, p. 74
 EHCY Electric Hydraulic Tool, p. 76

HX3 TOOL SERIES OPTIONS FOR X-DIES

HX3 Hand Tools, p. 70 & 75
 PHX3 Pneumatic Tool, p. 75

M81824/10-01 TO -03, SIZES 26 TO 12



Similar Splice Shown

TYPE: Class 1 Insulated Splices
INSULATION: Heat Shrinkable Polyvinylidene Flouride
SPLICE BODY & SLEEVE: Copper, ASTM B-280 or B75-68 or B152
PLATING: Nickel, SAE AMS-QQ-N290
SEALING MATERIAL: Modified Thermoplastic
MAX TEMP RATING: 175° C

Tool Selection Guide*

SPLICE SPECS						DMC TOOL/DIE OPTIONS			
AWG	WIRE SIZE MM	MULTIPLE CONDUCTORS CMA RANGE	SLEEVE COLOR	TERMINAL/SPLICE PART NUMBER		GMT SERIES MIL* APPROVED	HX4 SERIES MIL* APPROVED	HX3 SERIES MIL* APPROVED	HX4 SERIES DIE
#26-20	0.15-0.61	304 - 1510	Red	M81824/10-	01	GMT232	Y540 Die	X528 Die	Y516 Die
#20-16	0.39-1.34	779 - 2680	Blue	M81824/10-	02	GMT232	Y540 Die	X528 Die	Y516 Die
#16-12	0.95-3.37	1900 - 6755	Yellow	M81824/10-	03	GMT232	Y539 Die	X527 Die	Y516 Die

* If MIL Approval is required, QPL status should be verified. Consult DMC for current status.

Splice Manufacturers' Part Numbers

SPLICE SPECS				SPLICE MANUFACTURERS' SPLICE #						
AWG	SLEEVE COLOR	TERMINAL/SPLICE PART NUMBER		BURNDY	HOLLINGSWORTH	MOLEX	PANDUIT	THOMAS & BETTS	TYCO ELEC (RAYCHEM)	SUMITOMO
#26-20	Red	M81824/10-	01	--	--	--	--	--	D-436-88	--
#20-16	Blue	M81824/10-	02	--	--	--	--	--	D-436-89	--
#16-12	Yellow	M81824/10-	03	--	--	--	--	--	D-436-90	--

NOTE: Component manufactures' and OEM instructions shall take precedence over the information presented in these charts. Wire ranges are for reference only.

GMT TOOL SERIES OPTIONS

GMTxxx Hand Tool, p. 102
 GMTEBxxx Battery Tool, p. 104
 GMTExxx-R Battery Tool, p. 105

HX4 TOOL SERIES OPTIONS FOR Y-DIES

HX4 Hand Tools, p. 70 & 75
 HXE4B, HXE4-R Battery Tools, p. 72 & 73
 HX23 Pneumatic Tool, p. 74
 EHCY Electric Hydraulic Tool, p. 76

HX3 TOOL SERIES OPTIONS FOR X-DIES

HX3 Hand Tools, p. 70 & 75
 PHX3 Pneumatic Tool, p. 75



Similar Splice Shown

M81824/11-01 TO -03, SIZES 26 TO 12

TYPE: Class 1 Insulated Splices

INSULATION: Heat-Shrinkable Cross-Linked Polyvinylidene Fluoride, (SAE AMS-DTL-23053/18)

SPLICE BODY & SLEEVE: Copper, ASTM B-280, B-75, or B-187

PLATING: Nickel, SAE AMS-QQ-N290

SEALING MATERIAL: Modified Thermoplastic

MAX TEMP RATING: 200° C

Tool Selection Guide*

SPLICE SPECS						DMC TOOL/DIE OPTIONS			
AWG	WIRE SIZE MM	MULTIPLE CONDUCTORS CMA RANGE	SLEEVE COLOR	TERMINAL/SPLICE PART NUMBER		GMT SERIES MIL* APPROVED	HX4 SERIES MIL* APPROVED	HX3 SERIES MIL* APPROVED	HX4 SERIES DIE
#26-20	0.15-0.61	304 - 1510	Red	M81824/11-	01	GMT232	Y540 Die	X528 Die	Y516 Die
#20-16	0.39-1.34	779 - 2680	Blue	M81824/11-	02	GMT232	Y540 Die	X528 Die	Y516 Die
#16-12	0.95-3.37	1900 - 6755	Yellow	M81824/11-	03	GMT232	Y539 Die	X527 Die	Y516 Die

* If MIL Approval is required, QPL status should be verified. Consult DMC for current status.

Splice Manufacturers' Part Numbers

SPLICE SPECS				SPLICE MANUFACTURERS' SPLICE #						
AWG	SLEEVE COLOR	TERMINAL/SPLICE PART NUMBER		BURNDY	HOLLINGSWORTH	MOLEX	PANDUIT	THOMAS & BETTS	TYCO ELEC (RAYCHEM)	SUMITOMO
#26-20	Red	M81824/11-	01	--	--	--	--	--	D-200-82	--
#20-16	Blue	M81824/11-	02	--	--	--	--	--	D-200-83	--
#16-12	Yellow	M81824/11-	03	--	--	--	--	--	D-200-84	--

NOTE: Component manufactures' and OEM instructions shall take precedence over the information presented in these charts. Wire ranges are for reference only.

GMT TOOL SERIES OPTIONS

GMTxxx Hand Tool, p. 102
 GMTEBxxx Battery Tool, p. 104
 GMTExxx-R Battery Tool, p. 105

HX4 TOOL SERIES OPTIONS FOR Y-DIES

HX4 Hand Tools, p. 70 & 75
 HXE4B, HXE4-R Battery Tools, p. 72 & 73
 HX23 Pneumatic Tool, p. 74
 EHCY Electric Hydraulic Tool, p. 76

HX3 TOOL SERIES OPTIONS FOR X-DIES

HX3 Hand Tools, p. 70 & 75
 PHX3 Pneumatic Tool, p. 75



Similar Splice Shown

M81824/12-01 TO -03, SIZES 26 TO 12

TYPE: Class 1 Splice, Environment Resistant, Heatless Sealing
INSULATION: Preformed Nylon with Colored End Cap, Gel Seal
TERMINAL BODY & SLEEVE: Copper
PLATING: Tin Coated
SEALING MATERIAL: Non-Opaque Gel
MAX TEMP RATING: 150° C

Tool Selection Guide*

SPLICE SPECS					DMC TOOL/DIE OPTIONS		
AWG	WIRE SIZE MM	MULTIPLE CONDUCTORS CMA RANGE	END CAP COLOR	TERMINAL/SPLICE PART NUMBER	GMT SERIES MIL APPROVED*	HX4 SERIES MIL APPROVED*	
#26-20	--	--	Red	M81824/12-01	GMT1090	Y1090-1	
#20-16	--	--	Blue	M81824/12-02	GMT1090	Y1090-1	
#14-12	--	--	Yellow	M81824/12-03	GMT1090	Y1090-2	

* If MIL Approval is required, QPL status should be verified. Consult DMC for current status.

Splice Manufacturers' Part Numbers

SPLICE SPECS				SPLICE MANUFACTURERS' SPLICE #						
AWG	END CAP COLOR	TERMINAL/SPLICE PART NUMBER		BURNDY	HOLLINGSWORTH	MOLEX	PANDUIT	THOMAS & BETTS	TYCO ELEC (RAYCHEM)	SUMITOMO
#26-20	Red	M81824/12-	01	--	--	--	--	--	D-436-36-COLD	--
#20-16	Blue	M81824/12-	02	--	--	--	--	--	D-436-37-COLD	--
#14-12	Yellow	M81824/12-	03	--	--	--	--	--	D-436-38-COLD	--

NOTE: Component manufactures' and OEM instructions shall take precedence over the information presented in these charts. Wire ranges are for reference only.

GMT TOOL SERIES OPTIONS

GMTxxx Hand Tool, p. 102
 GMTEBxxx Battery Tool, p. 104
 GMTExxx-R Battery Tool, p. 105

HX4 TOOL SERIES OPTIONS FOR Y-DIES

HX4 Hand Tools, p. 70 & 75
 HXE4B, HXE4-R Battery Tools, p. 72 & 73
 HX23 Pneumatic Tool, p. 74
 EHCY Electric Hydraulic Tool, p. 76



Similar Terminal Shown

MS17143-1 to -10, Sizes 22 to 10

TYPE: Class 1 Insulated Terminals, Rectangular Tongue
INSULATION: Nylon, UL 94V-2
TERMINAL BODY & SLEEVE: Copper, ASTM B-152
PLATING: Tin, ASTM B-545
MAX TEMP RATING: 105° C

Tool Selection Guide*

TERMINAL SPECS						DMC TOOL/DIE OPTIONS				
AWG	WIRE SIZE MM	INSULATION DIAMETER IN. (MM)	SLEEVE COLOR	TERMINAL/SPLICE PART NUMBER		HX4 SERIES MIL APPROVED*	HX3 SERIES MIL APPROVED*	MIL APPROVED TOOL*	HX4 SERIES SINGLE CAVITY	HX4 SERIES MULTI CAVITY
#22-18	0.26-0.96	.140 (3.56)	Red	MS 17143	1	Y501 Die	X511 Die	M22520/40-01	Y672 Die	Y1060 Die
#16-14	1.04 - 2.62	.170 (4.32)	Blue	MS 17143	2	Y501 Die	X511 Die	M22520/40-01	Y671 Die	Y1060 Die
#12-10	2.62 - 6.64	.230 (5.84)	Yellow	MS 17143	3	Y501 Die	X515 Die	--	Y670 Die	--
#22-18	0.26-0.96	.140 (3.56)	Red	MS 17143	4	Y501 Die	X511 Die	M22520/40-01	Y672 Die	Y1060 Die
#16-14	1.04 - 2.62	.170 (4.32)	Blue	MS 17143	5	Y501 Die	X511 Die	M22520/40-01	Y671 Die	Y1060 Die
#12-10	2.62 - 6.64	.230 (5.84)	Yellow	MS 17143	6	Y501 Die	X515 Die	--	Y670 Die	--
#22-18	0.26-0.96	.140 (3.56)	Red	MS 17143	7	Y501 Die	X511 Die	M22520/40-01	Y672 Die	Y1060 Die
#16-14	1.04 - 2.62	.170 (4.32)	Blue	MS 17143	8	Y501 Die	X511 Die	M22520/40-01	Y671 Die	Y1060 Die
#12-10	2.62 - 6.64	.230 (5.84)	Yellow	MS 17143	9	Y501 Die	X515 Die	--	Y670 Die	--
#22-18	0.26-0.96	.140 (3.56)	Red	MS 17143	10	Y501 Die	X511 Die	M22520/40-01	Y672 Die	Y1060 Die

* If MIL Approval is required, QPL status should be verified. Consult DMC for current status.

Terminal Manufacturers' Part Numbers

TERMINAL SPECS				TERMINAL MANUFACTURERS' TERMINAL #					
AWG	SLEEVE COLOR	TERMINAL/SPLICE PART NUMBER		FCI BURNDY	HOLLINGSWORTH	MOLEX	PANDUIT	THOMAS&BETTS	TYCO ELEC
#22-18	Red	MS 17143	1	--	--	AA-880-1	--	RA 480	327932
#16-14	Blue	MS 17143	2	--	--	BB-880-2	--	RB 480	2-327934-2
#12-10	Yellow	MS 17143	3	--	--	--	--	RC 480	327936
#22-18	Red	MS 17143	4	--	--	AA-881-1	--	RA 481	2-327938-1
#16-14	Blue	MS 17143	5	--	--	BB-881-2	--	RB 481	2-327940-4
#12-10	Yellow	MS 17143	6	--	--	--	--	RC 481	327942
#22-18	Red	MS 17143	7	--	--	AA-882-1	--	RA 482	327944
#16-14	Blue	MS 17143	8	--	--	BB-882-2	--	RB 482	2-327946-4
#12-10	Yellow	MS 17143	9	--	--	--	--	RC 482	327948
#22-18	Red	MS 17143	10	--	--	AA-883-1	--	RA 483	2-327950-1

NOTE: Component manufactures' instructions shall take precedence over the information presented in these charts. Wire ranges are for reference only.

HX4 TOOL SERIES OPTIONS FOR Y-DIES

HX4 Hand Tools, p. 70 & 75
 HXE4B, HXE4-R Battery Tools, p. 72 & 73
 HX23 Pneumatic Tool, p. 74
 EHCY Electric Hydraulic Tool, p. 76

HX3 TOOL SERIES OPTIONS FOR X-DIES

HX3 Hand Tools, p. 70 & 75
 PHX3 Pneumatic Tool, p. 75



MS17143-11 to -21, Sizes 22 to 10

TYPE: Class 1 Insulated Terminals, Rectangular Tongue
INSULATION: Nylon, UL 94V-2
TERMINAL BODY & SLEEVE: Copper, ASTM B-152
PLATING: Tin, ASTM B-545
MAX TEMP RATING: 105° C

Similar Terminal Shown

Tool Selection Guide*

TERMINAL SPECS						DMC TOOL/DIE OPTIONS				
AWG	WIRE SIZE MM	INSULATION DIAMETER IN. (MM)	SLEEVE COLOR	TERMINAL/SPLICE PART NUMBER		HX4 SERIES MIL APPROVED*	HX3 SERIES MIL APPROVED*	MIL APPROVED TOOL*	HX4 SERIES SINGLE CAVITY	HX4 SERIES MULTI CAVITY
#16-14	1.04 - 2.62	.170 (4.32)	Blue	MS 17143	11	Y501 Die	X511 Die	M22520/40-01	Y671 Die	Y1060 Die
#12-10	2.62 - 6.64	.230 (5.84)	Yellow	MS 17143	12	Y501 Die	X515 Die	--	Y670 Die	--
#22-18	0.26-0.96	.140 (3.56)	Red	MS 17143	13	Y501 Die	X511 Die	M22520/40-01	Y672 Die	Y1060 Die
#16-14	1.04 - 2.62	.170 (4.32)	Blue	MS 17143	14	Y501 Die	X511 Die	M22520/40-01	Y671 Die	Y1060 Die
#12-10	2.62 - 6.64	.230 (5.84)	Yellow	MS 17143	15	Y501 Die	X515 Die	--	Y670 Die	--
#22-18	0.26-0.96	.140 (3.56)	Red	MS 17143	16	Y501 Die	X511 Die	M22520/40-01	Y672 Die	Y1060 Die
#16-14	1.04 - 2.62	.170 (4.32)	Blue	MS 17143	17	Y501 Die	X511 Die	M22520/40-01	Y671 Die	Y1060 Die
#12-10	2.62 - 6.64	.230 (5.84)	Yellow	MS 17143	18	Y501 Die	X515 Die	--	Y670 Die	--
#22-18	0.26-0.96	.140 (3.56)	Red	MS 17143	19	Y501 Die	X511 Die	M22520/40-01	Y672 Die	Y1060 Die
#16-14	1.04 - 2.62	.170 (4.32)	Blue	MS 17143	20	Y501 Die	X511 Die	M22520/40-01	Y671 Die	Y1060 Die
#12-10	2.62 - 6.64	.230 (5.84)	Yellow	MS 17143	21	Y501 Die	X515 Die	--	Y670 Die	--

* If MIL Approval is required, QPL status should be verified. Consult DMC for current status.

Terminal Manufacturers' Part Numbers

TERMINAL SPECS				TERMINAL MANUFACTURERS' TERMINAL #					
AWG	SLEEVE COLOR	TERMINAL/SPLICE PART NUMBER		FCI BURNDY	HOLLINGSWORTH	MOLEX	PANDUIT	THOMAS&BETTS	TYCO ELEC
#16-14	Blue	MS 17143	11	--	--	BB-883-2	--	RB 483	2-327952-2
#12-10	Yellow	MS 17143	12	--	--	--	--	RC 483	327954
#22-18	Red	MS 17143	13	--	--	AA-884-1	--	RA 484	2-327956-1
#16-14	Blue	MS 17143	14	--	--	BB-884-2	--	RB 484	2-327958-4
#12-10	Yellow	MS 17143	15	--	--	--	--	RC 484	2-327960-1
#22-18	Red	MS 17143	16	--	--	AA-885-1	--	RA 485	327962
#16-14	Blue	MS 17143	17	--	--	BB-885-2	--	RB 485	2-327964-4
#12-10	Yellow	MS 17143	18	--	--	-	--	RC 485	327966
#22-18	Red	MS 17143	19	--	--	AA-886-1	--	RA 486	2-327968-1
#16-14	Blue	MS 17143	20	--	--	BB-886-2	--	RB 486	2-327970-4
#12-10	Yellow	MS 17143	21	--	--	--	--	RC 486	327972

NOTE: Component manufactures' instructions shall take precedence over the information presented in these charts. Wire ranges are for reference only.

HX4 TOOL SERIES OPTIONS FOR Y-DIES

HX4 Hand Tools, p. 70 & 75
 HXE4B, HXE4-R Battery Tools, p. 72 & 73
 HX23 Pneumatic Tool, p. 74
 EHCY Electric Hydraulic Tool, p. 76

HX3 TOOL SERIES OPTIONS FOR X-DIES

HX3 Hand Tools, p. 70 & 75
 PHX3 Pneumatic Tool, p. 75



Similar Terminal Shown

MS20659-101 TO -106, SIZES 22 TO 10

TYPE: Class 1 Uninsulated Terminals, Ring Tongue
INSULATION: None
TERMINAL BODY & SLEEVE: Copper, ASTM B-152
PLATING: Tin, ASTM B-545
MAX TEMP RATING: 175° C

Tool Selection Guide*

TERMINAL SPECS					DMC TOOL/DIE OPTIONS					
AWG	WIRE SIZE MM	INSULATION DIAMETER IN. (MM)	SLEEVE COLOR	TERMINAL/SPLICE PART NUMBER	HX4 SERIES MULTI CAVITY (1 INDENT)	HX4 SERIES MULTI CAVITY (2 INDENTS)	GMT SERIES TOOL (1 INDENT)	GMT SERIES TOOL (2 INDENTS)	DCT4 SERIES	
#22-18	0.26-0.96	N/A	N/A	MS20659-	101	Y554 Die	Y788 Die	GMT277	GMT1005	DCT4-105D Die
					102	Y554 Die	Y788 Die	GMT277	GMT1005	DCT4-105D Die
#16-14	1.04 - 2.62	N/A	N/A	MS20659-	103	Y554 Die	Y788 Die	GMT277	GMT1005	DCT4-105D Die
					104	Y554 Die	Y788 Die	GMT277	GMT1005	DCT4-105D Die
#12-10	2.62 - 6.64	N/A	N/A	MS20659-	105	Y554 Die	Y788 Die	GMT277	GMT1005	DCT4-105D Die
					106	Y554 Die	Y788 Die	GMT277	GMT1005	DCT4-105D Die

* If MIL Approval is required, QPL status should be verified. Consult DMC for current status.

Terminal Manufacturers' Part Numbers

TERMINAL SPECS			TERMINAL MANUFACTURERS' TERMINAL #						
AWG	SLEEVE COLOR	TERMINAL/SPLICE PART NUMBER	BURNDY	HOLLINGSWORTH	MOLEX	PANDUIT	THOMAS&BETTS	TYCO ELEC	
#22-18	N/A	MS20659-	101	--	--	--	--	A85G	--
			102	--	--	--	--	A87G	--
#16-14	N/A	MS20659-	103	--	--	--	--	B85G	--
			104	--	--	--	--	B87G	--
#12-10	N/A	MS20659-	105	YAV10	R3457B	C-328-10	P10-10R	C26	33457
			106	YAV10-T2	R3459B	C-330-56	P10-56R	C70	33459

NOTE: Component manufactures' and OEM instructions shall take precedence over the information presented in these charts. Wire ranges are for reference only.

GMT TOOL SERIES OPTIONS

GMTxxx Hand Tool, p. 102
 GMTEBxxx Battery Tool, p. 104
 GMTExxx-R Battery Tool, p. 105

HX4 TOOL SERIES OPTIONS FOR Y-DIES

HX4 Hand Tools, p. 70 & 75
 HXE4B, HXE4-R Battery Tools, p. 72 & 73
 HX23 Pneumatic Tool, p. 74
 EHCY Electric Hydraulic Tool, p. 76

DCT TOOL SERIES OPTIONS

DCT4 Hand Tool, p. 106
 DCTE4B Battery Tool, p. 106



Similar Terminal Shown

MS20659-107 TO -116, SIZES 8 TO 1

TYPE: Class 1 Uninsulated Terminals, Ring Tongue
INSULATION: None
TERMINAL BODY & SLEEVE: Copper, ASTM B-152
PLATING: Tin, ASTM B-545
MAX TEMP RATING: 175° C

Tool Selection Guide*

TERMINAL SPECS					DMC TOOL/DIE OPTIONS			
AWG	WIRE SIZE MM	INSULATION DIAMETER IN. (MM)	SLEEVE COLOR	TERMINAL/SPLICE PART NUMBER	HD485 DIES MIL APPROVED*	HD51 SERIES	HD36 SERIES	
#8	6.64 - 10.5	N/A	N/A	MS20659-	107	HD485-8 Die	HD51-118N Die	HD36-111N Die
					108	HD485-8 Die	HD51-118N Die	HD36-111N Die
#6	10.5 - 16.8	N/A	N/A	MS20659-	109	HD485-6 Die	HD51-119N Die	HD36-112N Die
					110	HD485-6 Die	HD51-119N Die	HD36-112N Die
#4	16.8 - 26.7	N/A	N/A	MS20659-	111	HD485-4 Die	HD51-120N Die	HD36-113N Die
					112	HD485-4 Die	HD51-120N Die	HD36-113N Die
#2	26.7 - 42.4	N/A	N/A	MS20659-	113	HD485-2 Die	HD51-121N Die	HD36-114N Die
					114	HD485-2 Die	HD51-121N Die	HD36-114N Die
#1	40.0-42.0	N/A	N/A	MS20659-	115	HD485-1 Die	--	--
					116	HD485-1 Die	--	--

* If MIL Approval is required, QPL status should be verified. Consult DMC for current status.

Terminal Manufacturers' Part Numbers

TERMINAL SPECS			TERMINAL MANUFACTURERS' TERMINAL #						
AWG	SLEEVE COLOR	TERMINAL/SPLICE PART NUMBER	BURNDY	HOLLINGSWORTH	MOLEX	PANDUIT	THOMAS&BETTS	TYCO ELEC	
#8	N/A	MS20659-	107	YAV8C-L	--	--	--	D10361	--
			108	YAV8C-L2	--	--	--	D10721	--
#6	N/A	MS20659-	109	YAV6C-L	--	--	--	E10711	--
			110	YAV6C-L2	--	--	--	E10731	--
#4	N/A	MS20659-	111	YAV4C-L	--	--	--	F10711	--
			112	YAV4C-L2	--	--	--	F10731	--
#2	N/A	MS20659-	113	YAV2C-L1	--	--	--	G971	--
			114	YAV2C-L	--	--	--	G973	--
#1	N/A	MS20659-	115	YAV1C-L1	--	--	--	H971	--
			116	YAV1C-L	--	--	--	H973	--

NOTE: Component manufactures' and OEM instructions shall take precedence over the information presented in these charts. Wire ranges are for reference only.

HD485 TOOL OPTIONS

HH80C Hand Tool, p. 114
 TBHD1M Pneumatic Tool, p. 114

HD36 TOOL SERIES OPTIONS

HD36 Hand Tool, p. 109
 HDE36B Battery Tool, p. 110
 EHCD36 Electric Hydraulic Tool, p. 111

HD51 TOOL SERIES OPTIONS

HD51 Hand Tool, p. 112
 XHD51 Pneumatic Tool, p. 112

MS20659-117 TO -124, SIZES 1/0 TO 4/0



Similar Terminal Shown

TYPE: Class 1 Uninsulated Terminals, Ring Tongue
INSULATION: None
TERMINAL BODY & SLEEVE: Copper, ASTM B-152
PLATING: Tin, ASTM B-545
MAX TEMP RATING: 175° C

Tool Selection Guide*

TERMINAL SPECS					DMC TOOL/DIE OPTIONS		
AWG	WIRE SIZE MM	INSULATION DIAMETER IN. (MM)	SLEEVE COLOR	TERMINAL/SPLICE PART NUMBER	HD485 DIES MIL APPROVED*	HD51 SERIES	
#1/0	42.4-60.6	N/A	N/A	MS20659-	117	HD485-01 Die	HD51-123N Die
					118	HD485-01 Die	HD51-123N Die
#2/0	60.6-76.3	N/A	N/A	MS20659-	119	HD485-02 Die	HD51-124N Die
					120	HD485-02 Die	HD51-124N Die
#3/0	76.3-96.3	N/A	N/A	MS20659-	121	HD485-03 Die	--
					122	HD485-03 Die	--
#4/0	96.3-117	N/A	N/A	MS20659-	123	HD485-04 Die	--
					124	HD485-04 Die	--

* If MIL Approval is required, QPL status should be verified. Consult DMC for current status.

Terminal Manufacturers' Part Numbers

TERMINAL SPECS			TERMINAL MANUFACTURERS' TERMINAL #						
AWG	SLEEVE COLOR	TERMINAL/SPLICE PART NUMBER	BURNDY	HOLLINGSWORTH	MOLEX	PANDUIT	THOMAS&BETTS	TYCO ELEC	
#1/0	N/A	MS20659-	117	YAV25-L1	--	--	J971	--	
			118	YAV25-L	--	--	J973	--	
#2/0	N/A	MS20659-	119	YAV26-L2	--	--	K972	--	
			120	YAV26-L	--	--	K973	--	
#3/0	N/A	MS20659-	121	YAV27-L	--	--	L973	--	
			122	YAV27-L1	--	--	L975	--	
#4/0	N/A	MS20659-	123	YAV28-L	--	--	M973	--	
			124	YAV28-L12	--	--	M975	--	

NOTE: Component manufactures' and OEM instructions shall take precedence over the information presented in these charts. Wire ranges are for reference only.

HD485 TOOL OPTIONS

HH80C Hand Tool, p. 114
 TBHD1M Pneumatic Tool, p. 114

HD51 TOOL SERIES OPTIONS

HD51 Hand Tool, p. 112
 XHD51 Pneumatic Tool, p. 112



Similar Terminal Shown

MS20659-125 TO -128, SIZES 22 TO 10

TYPE: Class 1 Uninsulated Terminals, Ring Tongue
INSULATION: None
TERMINAL BODY & SLEEVE: Copper, ASTM B-152
PLATING: Tin, ASTM B-545
MAX TEMP RATING: 175° C

Tool Selection Guide*

TERMINAL SPECS					DMC TOOL/DIE OPTIONS					
AWG	WIRE SIZE MM	INSULATION DIAMETER IN. (MM)	SLEEVE COLOR	TERMINAL/SPLICE PART NUMBER		HX4 SERIES MULTI CAVITY (1 INDENT)	HX4 SERIES MULTI CAVITY (2 INDENTS)	GMT SERIES TOOL (1 INDENT)	GMT SERIES TOOL (2 INDENTS)	DCT4 SERIES
#22-18	0.26 - 0.96	N/A	N/A	MS20659-	125	Y554 Die	Y788 Die	GMT277	GMT1005	DCT4-105D Die
#16-14	1.04 - 2.62	N/A	N/A	MS20659-	126	Y554 Die	Y788 Die	GMT277	GMT1005	DCT4-105D Die
					127	Y554 Die	Y788 Die	GMT277	GMT1005	DCT4-105D Die
#12-10	2.62 - 6.64	N/A	N/A	MS20659-	128	Y554 Die	Y788 Die	GMT277	GMT1005	DCT4-105D Die

* If MIL Approval is required, QPL status should be verified. Consult DMC for current status.

Terminal Manufacturers' Part Numbers

TERMINAL SPECS				TERMINAL MANUFACTURERS' TERMINAL #					
AWG	SLEEVE COLOR	TERMINAL/SPLICE PART NUMBER		BURNDY	HOLLINGSWORTH	MOLEX	PANDUIT	THOMAS&BETTS	TYCO ELEC
#22-18	N/A	MS20659-	125	--	--	--	--	--	--
#16-14	N/A	MS20659-	126	--	--	--	--	--	--
		MS20659-	127	--	--	--	--	--	--
#12-10	N/A	MS20659-	128	YAV10-T4	R3220B	C-340-38	P10-38R	C73	33220

NOTE: Component manufactures' and OEM instructions shall take precedence over the information presented in these charts. Wire ranges are for reference only.

GMT TOOL SERIES OPTIONS

GMTxxx Hand Tool, p. 102
 GMTEBxxx Battery Tool, p. 104
 GMTExxx-R Battery Tool, p. 105

HX4 TOOL SERIES OPTIONS FOR Y-DIES

HX4 Hand Tools, p. 70 & 75
 HXE4B, HXE4-R Battery Tools, p. 72 & 73
 HX23 Pneumatic Tool, p. 74
 EHCY Electric Hydraulic Tool, p. 76

DCT TOOL SERIES OPTIONS

DCT4 Hand Tool, p. 106
 DCTE4B Battery Tool, p. 106

MS20659-129 TO -134, SIZES 6 TO 1



Similar Terminal Shown

TYPE: Class 1 Uninsulated Terminals, Ring Tongue
INSULATION: None
TERMINAL BODY & SLEEVE: Copper, ASTM B-152
PLATING: Tin, ASTM B-545
MAX TEMP RATING: 175° C

Tool Selection Guide*

TERMINAL SPECS						DMC TOOL/DIE OPTIONS			
AWG	WIRE SIZE MM	INSULATION DIAMETER IN. (MM)	SLEEVE COLOR	TERMINAL/SPLICE PART NUMBER		HD485 DIES MIL APPROVED*	HD51 SERIES	HD36 SERIES	HX4 SERIES
#8	6.64 - 10.5	N/A	N/A	MS20659-	129	HD485-8 Die	HD51-118N Die	HD36-111N Die	Y845HN Die
#6	10.5 - 16.8	N/A	N/A	MS20659-	130	HD485-6 Die	HD51-119N Die	HD36-112N Die	Y847HN Die
					131	HD485-6 Die	HD51-119N Die	HD36-112N Die	Y847HN Die
#4	16.8 - 26.7	N/A	N/A	MS20659-	132	HD485-4 Die	HD51-120N Die	HD36-113N Die	--
#2	26.7 - 42.4	N/A	N/A	MS20659-	133	HD485-4 Die	HD51-120N Die	HD36-113N Die	--
#1	40.0-42.0	N/A	N/A	MS20659-	134	HD485-1 Die	--	--	--

* If MIL Approval is required, QPL status should be verified. Consult DMC for current status.

Terminal Manufacturers' Part Numbers

TERMINAL SPECS				TERMINAL MANUFACTURERS' TERMINAL #					
AWG	SLEEVE COLOR	TERMINAL/SPLICE PART NUMBER		BURNDY	HOLLINGSWORTH	MOLEX	PANDUIT	THOMAS&BETTS	TYCO ELEC
#8	N/A	MS20659-	129	YAV8C-L3	--	--	--	D10731	--
#6	N/A	MS20659-	130	YAV6C-L1	--	--	--	E10261	--
#6	N/A	MS20659-	131	YAV6C-L4	--	--	--	E10721	--
#4	N/A	MS20659-	132	YAV4C-L4	--	--	--	F10721	--
#2	N/A	MS20659-	133	YAV2C-L4	--	--	--	G975	--
#1	N/A	MS20659-	134	YAV1C-L4	--	--	--	H975	--

NOTE: Component manufactures' and OEM instructions shall take precedence over the information presented in these charts. Wire ranges are for reference only.

HD485 TOOL OPTIONS

HH80C Hand Tool, p. 114
 TBHD1M Pneumatic Tool, p. 114

HX4 TOOL SERIES OPTIONS FOR Y-DIES

HD37 Hand Tool, p. 108
 HDE37B Battery Tool, p. 108
 HX23 Pneumatic Tool, p. 74
 EHCY Electric Hydraulic Tool, p. 76

HD36 TOOL SERIES OPTIONS

HD36 Hand Tool, p. 109
 HDE36B Battery Tool, p. 110
 EHCD36 Electric Hydraulic Tool, p. 111

HD51 TOOL SERIES OPTIONS

HD51 Hand Tool, p. 112
 XHD51 Pneumatic Tool, p. 112



Similar Terminal Shown

MS20659-135 TO -137, SIZES 1/0 TO 4/0

TYPE: Class 1 Uninsulated Terminals, Ring Tongue

INSULATION: None

TERMINAL BODY & SLEEVE: Copper, ASTM B-152

PLATING: Tin, ASTM B-545

MAX TEMP RATING: 175° C

Tool Selection Guide*

TERMINAL SPECS					DMC TOOL/DIE OPTIONS		
AWG	WIRE SIZE MM	INSULATION DIAMETER IN. (MM)	SLEEVE COLOR	TERMINAL/SPLICE PART NUMBER	HD485 DIES MIL APPROVED*	HD51 SERIES	
#1/0	42.4-60.6	N/A	N/A	MS20659-135	HD485-01 Die	HD51-123N Die	
#2/0	60.6-76.3	N/A	N/A	MS20659-136	HD485-02 Die	HD51-124N Die	
#4/0	96.3-117	N/A	N/A	MS20659-137	HD485-04 Die	--	

* If MIL Approval is required, QPL status should be verified. Consult DMC for current status.

Terminal Manufacturers' Part Numbers

TERMINAL SPECS				TERMINAL MANUFACTURERS' TERMINAL #					
AWG	SLEEVE COLOR	TERMINAL/SPLICE PART NUMBER		BURNDY	HOLLINGSWORTH	MOLEX	PANDUIT	THOMAS&BETTS	TYCO ELEC
#1/0	N/A	MS20659-135		YAV25-L3	--	--	--	J975	--
#2/0	N/A	MS20659-136		YAV26-L3	--	--	--	K975	--
#4/0	N/A	MS20659-137		YAV28-L54	--	--	--	--	--

NOTE: Component manufactures' and OEM instructions shall take precedence over the information presented in these charts. Wire ranges are for reference only.

HD485 TOOL OPTIONS

HH80C Hand Tool, p. 114
TBHD1M Pneumatic Tool, p. 114

HD51 TOOL SERIES OPTIONS

HD51 Hand Tool, p. 112
XHD51 Pneumatic Tool, p. 112



Similar Terminal Shown

MS20659-140 TO -150, SIZES 8 TO 1

TYPE: Class 1 Uninsulated Terminals, Ring Tongue

INSULATION: None

TERMINAL BODY & SLEEVE: Copper, ASTM B-152

PLATING: Tin, ASTM B-545

MAX TEMP RATING: 175° C

Tool Selection Guide*

TERMINAL SPECS					DMC TOOL/DIE OPTIONS				
AWG	WIRE SIZE MM	INSULATION DIAMETER IN. (MM)	SLEEVE COLOR	TERMINAL/SPLICE PART NUMBER	HD485 DIES MIL APPROVED*	HD51 SERIES	HD36 SERIES	HX4 SERIES	
#8	6.64 - 10.5	N/A	N/A	MS20659-	140	HD485-8 Die	HD51-118N Die	HD36-111N Die	Y845HN Die
					141	HD485-8 Die	HD51-118N Die	HD36-111N Die	Y845HN Die
					142	HD485-8 Die	HD51-118N Die	HD36-111N Die	Y845HN Die
#6	10.5 - 16.8	N/A	N/A	MS20659-	143	HD485-6 Die	HD51-119N Die	HD36-112N Die	Y847HN Die
#4	16.8 - 26.7	N/A	N/A	MS20659-	144	HD485-4 Die	HD51-120N Die	HD36-113N Die	--
					145	HD485-4 Die	HD51-120N Die	HD36-113N Die	--
#2	26.7 - 42.4	N/A	N/A	MS20659-	146	HD485-2 Die	HD51-121N Die	HD36-114N Die	--
					147	HD485-2 Die	HD51-121N Die	HD36-114N Die	--
					148	HD485-2 Die	HD51-121N Die	HD36-114N Die	--
#1	40.0-42.0	N/A	N/A	MS20659-	149	HD485-1 Die	--	--	--
					150	HD485-1 Die	--	--	--

* If MIL Approval is required, QPL status should be verified. Consult DMC for current status.

Terminal Manufacturers' Part Numbers

TERMINAL SPECS			TERMINAL MANUFACTURERS' TERMINAL #						
AWG	SLEEVE COLOR	TERMINAL/SPLICE PART NUMBER	BURNDY	HOLLINGSWORTH	MOLEX	PANDUIT	THOMAS&BETTS	TYCO ELEC	
#8	N/A	MS20659-	140	YAV8C-L14	--	--	D10161	--	
			141	YAV8C-L1	--	--	D10711	--	
			142	YAV8C-L4	--	--	--	--	
#6	N/A	MS20659-	143	YAV6C-L10	--	--	--	--	
#4	N/A	MS20659-	144	YAV4C-L3	--	--	F10261	--	
			145	YAV4C-L5	--	--	--	--	
#2	N/A	MS20659-	146	YAV2C-L3	--	--	G926	--	
			147	YAV2C-L2	--	--	G972	--	
			148	YAV2C-L11	--	--	G974	--	
#1	N/A	MS20659-	149	YAV1C-L2	--	--	H972	--	
			150	YAV1C-L4	--	--	H974	--	

NOTE: Component manufactures' and OEM instructions shall take precedence over the information presented in these charts. Wire ranges are for reference only.

HD485 TOOL OPTIONS

HH80C Hand Tool, p. 114
TBHD1M Pneumatic Tool, p. 114

HX4 TOOL SERIES OPTIONS FOR Y-DIES

HD37 Hand Tool, p. 108
HDE37B Battery Tool, p. 108
HX23 Pneumatic Tool, p. 74
EHCY Electric Hydraulic Tool, p. 76

HD36 TOOL SERIES OPTIONS

HD36 Hand Tool, p. 109
HDE36B Battery Tool, p. 110
EHCD36 Electric Hydraulic Tool, p. 111

HD51 TOOL SERIES OPTIONS

HD51 Hand Tool, p. 112
XHD51 Pneumatic Tool, p. 112



Similar Terminal Shown

MS20659-151 TO -160, SIZES 1/0 TO 4/0

TYPE: Class 1 Uninsulated Terminals, Ring Tongue
INSULATION: None
TERMINAL BODY & SLEEVE: Copper, ASTM B-152
PLATING: Tin, ASTM B-545
MAX TEMP RATING: 175° C

Tool Selection Guide*

TERMINAL SPECS					DMC TOOL/DIE OPTIONS		
AWG	WIRE SIZE MM	INSULATION DIAMETER IN. (MM)	SLEEVE COLOR	TERMINAL/SPLICE PART NUMBER	HD485 DIES MIL APPROVED*	HD51 SERIES	
#1/0	42.4-60.6	N/A	N/A	MS20659-	151	HD485-01 Die	HD51-123N Die
					152	HD485-01 Die	HD51-123N Die
#2/0	60.6-76.3	N/A	N/A	MS20659-	153	HD485-02 Die	HD51-124N Die
					154	HD485-02 Die	HD51-124N Die
#3/0	76.3-96.3	N/A	N/A	MS20659-	155	HD485-03 Die	--
					156	HD485-03 Die	--
#4/0	96.3-117	N/A	N/A	MS20659-	157	HD485-04 Die	--
					158	HD485-04 Die	--
					159	HD485-04 Die	--
					160	HD485-04 Die	--

* If MIL Approval is required, QPL status should be verified. Consult DMC for current status.

Terminal Manufacturers' Part Numbers

TERMINAL SPECS			TERMINAL MANUFACTURERS' TERMINAL #						
AWG	SLEEVE COLOR	TERMINAL/SPLICE PART NUMBER	BURNDY	HOLLINGSWORTH	MOLEX	PANDUIT	THOMAS&BETTS	TYCO ELEC	
#1/0	N/A	MS20659-	151	YAV25-L2	--	--	J972	--	
			152	YAV25-L16	--	--	J974	--	
#2/0	N/A	MS20659-	153	YAV26-L1	--	--	K971	--	
			154	YAV26-L16	--	--	K974	--	
#3/0	N/A	MS20659-	155	YAV27-L20	--	--	L972	--	
			156	YAV27-L18	--	--	L974	--	
#4/0	N/A	MS20659-	157	YAV1C-L11	--	--	M972	--	
			158	YAV28-L56	--	--	M974	--	
			159	YAV28-L13	--	--	--	--	
			160	YAV28-L14	--	--	--	--	

NOTE: Component manufactures' and OEM instructions shall take precedence over the information presented in these charts. Wire ranges are for reference only.

HD485 TOOL OPTIONS

HH80C Hand Tool, p. 114
 TBHD1M Pneumatic Tool, p. 114

HD51 TOOL SERIES OPTIONS

HD51 Hand Tool, p. 112
 XHD51 Pneumatic Tool, p. 112



Similar Terminal Shown

MS20659-161 TO -166, SIZES 22 TO 10

TYPE: Class 1 Uninsulated Terminals, Ring Tongue
INSULATION: None
TERMINAL BODY & SLEEVE: Copper, ASTM B-152
PLATING: Tin, ASTM B-545
MAX TEMP RATING: 175° C

Tool Selection Guide*

TERMINAL SPECS					DMC TOOL/DIE OPTIONS					
AWG	WIRE SIZE MM	INSULATION DIAMETER IN. (MM)	SLEEVE COLOR	TERMINAL/SPLICE PART NUMBER	HX4 SERIES MULTI CAVITY (1 INDENT)	HX4 SERIES MULTI CAVITY (2 INDENTS)	GMT SERIES TOOL (1 INDENT)	GMT SERIES TOOL (2 INDENTS)	DCT4 SERIES	
#22-18	0.26 - 0.96	N/A	N/A	MS20659-	161	Y554 Die	Y788 Die	GMT277	GMT1005	DCT4-105D Die
					162	Y554 Die	Y788 Die	GMT277	GMT1005	DCT4-105D Die
#16-14	1.04 - 2.62	N/A	N/A	MS20659-	163	Y554 Die	Y788 Die	GMT277	GMT1005	DCT4-105D Die
					164	Y554 Die	Y788 Die	GMT277	GMT1005	DCT4-105D Die
#12-10	2.62 - 6.64	N/A	N/A	MS20659-	165	Y554 Die	Y788 Die	GMT277	GMT1005	DCT4-105D Die
					166	Y554 Die	Y788 Die	GMT277	GMT1005	DCT4-105D Die

* If MIL Approval is required, QPL status should be verified. Consult DMC for current status.

Terminal Manufacturers' Part Numbers

TERMINAL SPECS			TERMINAL MANUFACTURERS' TERMINAL #						
AWG	SLEEVE COLOR	TERMINAL/SPLICE PART NUMBER	BURNDY	HOLLINGSWORTH	MOLEX	PANDUIT	THOMAS&BETTS	TYCO ELEC	
#22-18	N/A	MS20659-	161	--	--	--	--	--	
			162	--	--	--	--	--	
#16-14	N/A	MS20659-	163	--	--	--	--	--	
			164	--	--	--	--	--	
#12-10	N/A	MS20659-	165	YAV10-T7	R3453B	--	P10-6R	C33	--
			166	--	R3223B	--	--	C75	--

NOTE: Component manufactures' and OEM instructions shall take precedence over the information presented in these charts. Wire ranges are for reference only.

GMT TOOL SERIES OPTIONS

GMTxxx Hand Tool, p. 102
 GMTEBxxx Battery Tool, p. 104
 GMTExxx-R Battery Tool, p. 105

HX4 TOOL SERIES OPTIONS FOR Y-DIES

HX4 Hand Tools, p. 70 & 75
 HXE4B, HXE4-R Battery Tools, p. 72 & 73
 HX23 Pneumatic Tool, p. 74
 EHCY Electric Hydraulic Tool, p. 76

DCT TOOL SERIES OPTIONS

DCT4 Hand Tool, p. 106
 DCTE4B Battery Tool, p. 106



Similar Terminal Shown

MS21004-1 TO -7, SIZES 22 TO 18

TYPE: Class 1 Uninsulated Terminals, Rectangular Tongue

INSULATION: None

TERMINAL BODY & SLEEVE: Copper, ASTM B-152

PLATING: Tin, ASTM B-545

MAX TEMP RATING: 175° C

Tool Selection Guide*

TERMINAL SPECS					DMC TOOL/DIE OPTIONS					
AWG	WIRE SIZE MM	INSULATION DIAMETER IN. (MM)	SLEEVE COLOR	TERMINAL/SPLICE PART NUMBER	HX4 SERIES MULTI CAVITY (1 INDENT)	HX4 SERIES MULTI CAVITY (2 INDENTS)	GMT SERIES TOOL (1 INDENT)	GMT SERIES TOOL (2 INDENTS)	DCT4 SERIES	
#22-18	0.26-0.96	N/A	N/A	MS21004-	1	Y554 Die	Y788 Die	GMT277	GMT1005	DCT4-105D Die
					2	Y554 Die	Y788 Die	GMT277	GMT1005	DCT4-105D Die
					3	Y554 Die	Y788 Die	GMT277	GMT1005	DCT4-105D Die
					4	Y554 Die	Y788 Die	GMT277	GMT1005	DCT4-105D Die
					5	Y554 Die	Y788 Die	GMT277	GMT1005	DCT4-105D Die
					6	Y554 Die	Y788 Die	GMT277	GMT1005	DCT4-105D Die
					7	Y554 Die	Y788 Die	GMT277	GMT1005	DCT4-105D Die

* If MIL Approval is required, QPL status should be verified. Consult DMC for current status.

Terminal Manufacturers' Part Numbers

TERMINAL SPECS			TERMINAL MANUFACTURERS' TERMINAL #						
AWG	SLEEVE COLOR	TERMINAL/SPLICE PART NUMBER	BURNDY	HOLLINGSWORTH	MOLEX	PANDUIT	THOMAS&BETTS	TYCO ELEC	
#22-18	N/A	MS21004-	1	--	--	--	--	A486	--
			2	--	--	--	--	A483	--
			3	--	--	--	--	A482	--
			4	--	--	--	--	A481	--
			5	--	--	--	--	A485	--
			6	--	--	--	--	A484	--
			7	--	--	--	--	A480	--

NOTE: Component manufactures' and OEM instructions shall take precedence over the information presented in these charts. Wire ranges are for reference only.

GMT TOOL SERIES OPTIONS

GMTxxx Hand Tool, p. 102
 GMTEBxxx Battery Tool, p. 104
 GMTExxx-R Battery Tool, p. 105

HX4 TOOL SERIES OPTIONS FOR Y-DIES

HX4 Hand Tools, p. 70 & 75
 HXE4B, HXE4-R Battery Tools, p. 72 & 73
 HX23 Pneumatic Tool, p. 74
 EHCY Electric Hydraulic Tool, p. 76

DCT TOOL SERIES OPTIONS

DCT4 Hand Tool, p. 106
 DCTE4B Battery Tool, p. 106



Similar Terminal Shown

MS21004-8 TO -14, SIZES 16 TO 14

TYPE: Class 1 Uninsulated Terminals, Rectangular Tongue
INSULATION: None
TERMINAL BODY & SLEEVE: Copper, ASTM B-152
PLATING: Tin, ASTM B-545
MAX TEMP RATING: 175° C

Tool Selection Guide*

TERMINAL SPECS					DMC TOOL/DIE OPTIONS					
AWG	WIRE SIZE MM	INSULATION DIAMETER IN. (MM)	SLEEVE COLOR	TERMINAL/SPLICE PART NUMBER	HX4 SERIES MULTI CAVITY (1 INDENT)	HX4 SERIES MULTI CAVITY (2 INDENTS)	GMT SERIES TOOL (1 INDENT)	GMT SERIES TOOL (2 INDENTS)	DCT4 SERIES	
#16-14	1.04 - 2.62	N/A	N/A	MS21004-	8	Y554 Die	Y788 Die	GMT277	GMT1005	DCT4-105D Die
					9	Y554 Die	Y788 Die	GMT277	GMT1005	DCT4-105D Die
					10	Y554 Die	Y788 Die	GMT277	GMT1005	DCT4-105D Die
					11	Y554 Die	Y788 Die	GMT277	GMT1005	DCT4-105D Die
					12	Y554 Die	Y788 Die	GMT277	GMT1005	DCT4-105D Die
					13	Y554 Die	Y788 Die	GMT277	GMT1005	DCT4-105D Die
					14	Y554 Die	Y788 Die	GMT277	GMT1005	DCT4-105D Die

* If MIL Approval is required, QPL status should be verified. Consult DMC for current status.

Terminal Manufacturers' Part Numbers

TERMINAL SPECS			TERMINAL MANUFACTURERS' TERMINAL #						
AWG	SLEEVE COLOR	TERMINAL/SPLICE PART NUMBER	BURNDY	HOLLINGSWORTH	MOLEX	PANDUIT	THOMAS&BETTS	TYCO ELEC	
#16-14	N/A	MS21004-	8	--	--	--	--	B486	--
			9	--	--	--	--	B483	--
			10	--	--	--	--	B482	--
			11	--	--	--	--	B481	--
			12	--	--	--	--	B485	--
			13	--	--	--	--	B484	--
			14	--	--	--	--	B480	--

NOTE: Component manufactures' and OEM instructions shall take precedence over the information presented in these charts. Wire ranges are for reference only.

GMT TOOL SERIES OPTIONS

GMTxxx Hand Tool, p. 102
 GMTEBxxx Battery Tool, p. 104
 GMTExxx-R Battery Tool, p. 105

HX4 TOOL SERIES OPTIONS FOR Y-DIES

HX4 Hand Tools, p. 70 & 75
 HXE4B, HXE4-R Battery Tools, p. 72 & 73
 HX23 Pneumatic Tool, p. 74
 EHCY Electric Hydraulic Tool, p. 76

DCT TOOL SERIES OPTIONS

DCT4 Hand Tool, p. 106
 DCTE4B Battery Tool, p. 106



Similar Terminal Shown

MS21004-15 TO -21, SIZES 12 TO 10

TYPE: Class 1 Uninsulated Terminals, Rectangular Tongue

INSULATION: None

TERMINAL BODY & SLEEVE: Copper, ASTM B-152

PLATING: Tin, ASTM B-545

MAX TEMP RATING: 175° C

Tool Selection Guide*

TERMINAL SPECS					DMC TOOL/DIE OPTIONS					
AWG	WIRE SIZE MM	INSULATION DIAMETER IN. (MM)	SLEEVE COLOR	TERMINAL/SPLICE PART NUMBER	HX4 SERIES MULTI CAVITY (1 INDENT)	HX4 SERIES MULTI CAVITY (2 INDENTS)	GMT SERIES TOOL (1 INDENT)	GMT SERIES TOOL (2 INDENTS)	DCT4 SERIES	
#12-10	2.62 - 6.64	N/A	N/A	MS21004-	15	Y554 Die	Y788 Die	GMT277	GMT1005	DCT4-105D Die
					16	Y554 Die	Y788 Die	GMT277	GMT1005	DCT4-105D Die
					17	Y554 Die	Y788 Die	GMT277	GMT1005	DCT4-105D Die
					18	Y554 Die	Y788 Die	GMT277	GMT1005	DCT4-105D Die
					19	Y554 Die	Y788 Die	GMT277	GMT1005	DCT4-105D Die
					20	Y554 Die	Y788 Die	GMT277	GMT1005	DCT4-105D Die
					21	Y554 Die	Y788 Die	GMT277	GMT1005	DCT4-105D Die

* If MIL Approval is required, QPL status should be verified. Consult DMC for current status.

Terminal Manufacturers' Part Numbers

TERMINAL SPECS			TERMINAL MANUFACTURERS' TERMINAL #						
AWG	SLEEVE COLOR	TERMINAL/SPLICE PART NUMBER	BURNDY	HOLLINGSWORTH	MOLEX	PANDUIT	THOMAS&BETTS	TYCO ELEC	
#12-10	N/A	MS21004-	15	--	--	--	--	C486	--
			16	--	--	--	--	C483	--
			17	--	--	--	--	C482	--
			18	--	--	--	--	C481	--
			19	--	--	--	--	C485	--
			20	--	--	--	--	C484	--
			21	--	--	--	--	C480	--

NOTE: Component manufactures' and OEM instructions shall take precedence over the information presented in these charts. Wire ranges are for reference only.

GMT TOOL SERIES OPTIONS

GMTxxx Hand Tool, p. 102
 GMTEBxxx Battery Tool, p. 104
 GMTExxx-R Battery Tool, p. 105

HX4 TOOL SERIES OPTIONS FOR Y-DIES

HX4 Hand Tools, p. 70 & 75
 HXE4B, HXE4-R Battery Tools, p. 72 & 73
 HX23 Pneumatic Tool, p. 74
 EHCY Electric Hydraulic Tool, p. 76

DCT TOOL SERIES OPTIONS

DCT4 Hand Tool, p. 106
 DCTE4B Battery Tool, p. 106

MS25036-101 TO -110, SIZES 22 TO 14



Similar Terminal Shown

TYPE: Class 1 Insulated Terminals
INSULATION: Nylon, UL 94V-2
TERMINAL BODY & SLEEVE: Copper, ASTM B-152
PLATING: Tin, ASTM B-545
MAX TEMP RATING: 105° C

Tool Selection Guide*

TERMINAL SPECS					DMC TOOL/DIE OPTIONS					
AWG	WIRE SIZE MM	INSULATION DIAMETER IN. (MM)	SLEEVE COLOR	TERMINAL/SPLICE PART NUMBER	HX4 SERIES MIL APPROVED*	HX3 SERIES MIL APPROVED*	MIL APPROVED* TOOL	HX4 SERIES SINGLE CAVITY	HX4 SERIES MULTI CAVITY	
#22-18	0.26-0.96	.140 (3.56)	Red	MS25036-	101	Y501 Die	X511 Die	M22520/40-01	Y672 Die	Y1060 Die
					102	Y501 Die	X511 Die	M22520/40-01	Y672 Die	Y1060 Die
					103	Y501 Die	X511 Die	M22520/40-01	Y672 Die	Y1060 Die
					104	Y501 Die	X511 Die	M22520/40-01	Y672 Die	Y1060 Die
					105	Y501 Die	X511 Die	M22520/40-01	Y672 Die	Y1060 Die
#16-14	1.04 - 2.62	.170 (4.32)	Blue	MS25036-	106	Y501 Die	X511 Die	M22520/40-01	Y671 Die	Y1060 Die
					107	Y501 Die	X511 Die	M22520/40-01	Y671 Die	Y1060 Die
					108	Y501 Die	X511 Die	M22520/40-01	Y671 Die	Y1060 Die
					109	Y501 Die	X511 Die	M22520/40-01	Y671 Die	Y1060 Die
					110	Y501 Die	X511 Die	M22520/40-01	Y671 Die	Y1060 Die

* If MIL Approval is required, QPL status should be verified. Consult DMC for current status.

Terminal Manufacturers' Part Numbers

TERMINAL SPECS			TERMINAL MANUFACTURERS' TERMINAL #							
AWG	SLEEVE COLOR	TERMINAL/SPLICE PART NUMBER	BURNDY	HOLLINGSWORTH	MOLEX	PANDUIT	THOMAS&BETTS	TYCO ELEC		
#22-18	Red	MS25036-	101	YAES18-N1	XR1881 SN	AA-820-06	PN18-6RN	RA333	36150	36149
			102	YAES18-N2	XR1885 SN	AA-832-06	PN18-6R	RA853	51863	--
			103	YAES18-N3	XR1891 SN	AA-821-10	PN18-10R	RA873	36154	36153
			104	YAES18-N4	XR1895 SN	AA-822-56	PN18-56R	RA723	31895	320572
			105	YAES18-N5	XR1896 SN	AA-826-38	PN18-38R	RA733	31897	320573
#16-14	Blue	MS25036-	106	YAES14-N6	XR2442 SN	BB-823-06	PN14-6RN	RB1333	320561	--
			107	YAES14-N7	XR1901 SN	BB-837-06	PN14-6R	RB853	51864	--
			108	YAES14-N8	XR1903 SN	BB-837-10	PN14-10R	RB873	51864-2	--
			109	YAES14-N9	XR1907 SN	BB-825-56	PN14-56R	RB723	320575	--
			110	YAES14-N10	XR1908 SN	BB-818-38	PN14-38R	RB733	320564	--

NOTE: Component manufactures' and OEM instructions shall take precedence over the information presented in these charts. Wire ranges are for reference only.

HX4 TOOL SERIES OPTIONS FOR Y-DIES

HX4 Hand Tools, p. 70 & 75
 HXE4B, HXE4-R Battery Tools, p. 72 & 73
 HX23 Pneumatic Tool, p. 74
 EHCY Electric Hydraulic Tool, p. 76

HX3 TOOL SERIES OPTIONS FOR X-DIES

HX3 Hand Tools, p. 70 & 75
 PHX3 Pneumatic Tool, p. 75



Similar Terminal Shown

MS25036-111 TO -114, SIZES 12 TO 10

TYPE: Class 1 Insulated Terminals
INSULATION: Nylon, UL 94V-2
TERMINAL BODY & SLEEVE: Copper, ASTM B-152
PLATING: Tin, ASTM B-545
MAX TEMP RATING: 105° C

Tool Selection Guide*

TERMINAL SPECS					DMC TOOL/DIE OPTIONS			
AWG	WIRE SIZE MM	INSULATION DIAMETER IN. (MM)	SLEEVE COLOR	TERMINAL/SPLICE PART NUMBER	HX4 SERIES MIL APPROVED*	HX3 SERIES MIL APPROVED*	HX4 SERIES SINGLE CAVITY	
#12-10	2.62 - 6.64	.230 (5.84)	Yellow	MS25036-	111	Y501 Die	X515 Die	Y670 Die
					112	Y501 Die	X515 Die	Y670 Die
					113	Y501 Die	X515 Die	Y670 Die
					114	Y501 Die	X515 Die	Y670 Die

* If MIL Approval is required, QPL status should be verified. Consult DMC for current status.

Terminal Manufacturers' Part Numbers

TERMINAL SPECS			TERMINAL MANUFACTURERS' TERMINAL #							
AWG	SLEEVE COLOR	TERMINAL/SPLICE PART NUMBER	BURNDY	HOLLINGSWORTH	MOLEX	PANDUIT	THOMAS&BETTS	TYCO ELEC		
#12-10	Yellow	MS25036-	111	YAES10-N11	XR5107 N	C-828-06	PN10-6R	RC333	320567	35107
			112	YAES10-N12	XR5109 N	C-828-10	PN10-10R	RC363	36161	35109
			113	YAES10-N13	XR5111 N	C-830-56	PN10-56R	RC703	320576	35111
			114	YAES10-N14	XR5112 N	C-840-38	PN10-38R	RC733	320577	35112

NOTE: Component manufactures' and OEM instructions shall take precedence over the information presented in these charts. Wire ranges are for reference only.

HX4 TOOL SERIES OPTIONS FOR Y-DIES

HX4 Hand Tools, p. 70 & 75
 HXE4B, HXE4-R Battery Tools, p. 72 & 73
 HX23 Pneumatic Tool, p. 74
 EHCY Electric Hydraulic Tool, p. 76

HX3 TOOL SERIES OPTIONS FOR X-DIES

HX3 Hand Tools, p. 70 & 75
 PHX3 Pneumatic Tool, p. 75

MS25036-115 TO -122, SIZES 8 TO 6



Similar Terminal Shown

TYPE: Class 1 Insulated Terminals
INSULATION: Nylon, UL 94V-2
TERMINAL BODY & SLEEVE: Copper, ASTM B-152
PLATING: Tin, ASTM B-545
MAX TEMP RATING: 105° C

Tool Selection Guide*

TERMINAL SPECS					DMC TOOL/DIE OPTIONS				
AWG	WIRE SIZE MM	INSULATION DIAMETER IN. (MM)	SLEEVE COLOR	TERMINAL/SPLICE PART NUMBER	HD002 DIES MIL APPROVED*	HX4 SERIES	HD36 SERIES	HD51 SERIES	
#8	6.64 - 10.5	.290 (7.55)	Red	MS25036-	115	HD002-8 Die	Y673H Die	HD36-139 Die	HD51-105 Die
					116	HD002-8 Die	Y673H Die	HD36-139 Die	HD51-105 Die
					117	HD002-8 Die	Y673H Die	HD36-139 Die	HD51-105 Die
					118	HD002-8 Die	Y673H Die	HD36-139 Die	HD51-105 Die
#6	10.5 - 16.8	.370 (9.55)	Blue	MS25036-	119	HD002-6 Die	Y674H Die	HD36-136 Die	HD51-106 Die
					120	HD002-6 Die	Y674H Die	HD36-136 Die	HD51-106 Die
					121	HD002-6 Die	Y674H Die	HD36-136 Die	HD51-106 Die
					122	HD002-6 Die	Y674H Die	HD36-136 Die	HD51-106 Die

* If MIL Approval is required, QPL status should be verified. Consult DMC for current status.

Terminal Manufacturers' Part Numbers

TERMINAL SPECS			TERMINAL MANUFACTURERS' TERMINAL #						
AWG	SLEEVE COLOR	TERMINAL/SPLICE PART NUMBER	BURNDY	HOLLINGSWORTH	MOLEX	PANDUIT	THOMAS&BETTS	TYCO ELEC	
#8	Red	MS25036-	115	YAEV8C-L	--	--	--	RD10361	--
			116	YAEV8C-L1	--	--	--	RD10711	--
			117	YAEV8C-L2	--	--	--	RD10721	--
			118	YAEV8C-L3	--	--	--	RD10731	--
#6	Blue	MS25036-	119	YAEV6C-L1-M	--	--	--	RE10261	--
			120	YAEV6C-L-M	--	--	--	RE10711	--
			121	YAEV6C-L4-M	--	--	--	RE10721	--
			122	YAEV6C-L2-M	--	--	--	RE10731	--

NOTE: Component manufactures' and OEM instructions shall take precedence over the information presented in these charts. Wire ranges are for reference only.

HD002 TOOL OPTIONS

HH80C Hand Tool, p. 114
 TBHD1M Pneumatic Tool, p. 114

HX4 TOOL SERIES OPTIONS FOR Y-DIES

HD37 Hand Tool, p. 108
 HDE37B Battery Tool, p. 108
 HX23 Pneumatic Tool, p. 74
 EHCY Electric Hydraulic Tool, p. 76

HD36 TOOL SERIES OPTIONS

HD36 Hand Tool, p. 109
 HDE36B Battery Tool, p. 110
 EHCD36 Electric Hydraulic Tool, p. 111

HD51 TOOL SERIES OPTIONS

HD51 Hand Tool, p. 112
 XHD51 Pneumatic Tool, p. 112



Similar Terminal Shown

MS25036-123 TO -131, SIZES 4 TO 1

TYPE: Class 1 Insulated Terminals

INSULATION: Nylon, UL 94V-2

TERMINAL BODY & SLEEVE: Copper, ASTM B-152

PLATING: Tin, ASTM B-545

MAX TEMP RATING: 105° C

Tool Selection Guide*

TERMINAL SPECS					DMC TOOL/DIE OPTIONS			
AWG	WIRE SIZE MM	INSULATION DIAMETER IN. (MM)	SLEEVE COLOR	TERMINAL/SPLICE PART NUMBER	HD002 DIES MIL APPROVED*	HD36 SERIES	HD51 SERIES	
#4	16.8 - 26.7	.430 (11.05)	Yellow	MS25036-	123	HD002-4 Die	HD36-137 Die	HD51-107 Die
					124	HD002-4 Die	HD36-137 Die	HD51-107 Die
					125	HD002-4 Die	HD36-137 Die	HD51-107 Die
#2	26.7 - 42.4	.505 (12.83)	Red	MS25036-	126	HD002-2 Die	--	HD51-113 Die
					127	HD002-2 Die	--	HD51-113 Die
					128	HD002-2 Die	--	HD51-113 Die
#1	--	--	White	MS25036-	129	HD002-1 Die	--	HD51-154 Die
					130	HD002-1 Die	--	HD51-154 Die
					131	HD002-1 Die	--	HD51-154 Die

* If MIL Approval is required, QPL status should be verified. Consult DMC for current status.

Terminal Manufacturers' Part Numbers

TERMINAL SPECS			TERMINAL MANUFACTURERS' TERMINAL #						
AWG	SLEEVE COLOR	TERMINAL/SPLICE PART NUMBER	BURNDY	HOLLINGSWORTH	MOLEX	PANDUIT	THOMAS&BETTS	TYCO ELEC	
#4	Yellow	MS25036-	123	YAEV4C-L	--	--	--	RF10711	--
			124	YAEV4C-L4	--	--	--	RF10721	--
			125	YAEV4C-L2	--	--	--	RF10731	--
#2	Red	MS25036-	126	YAEV2C-L1	--	--	--	RG9711	--
			127	YAEV2C-L	--	--	--	RG9731	--
			128	YAEV8C-L4	--	--	--	RG9751	--
#1	White	MS25036-	129	YAEV1C-L1	--	--	--	RH9711	--
			130	YAEV1C-L	--	--	--	RH9731	--
			131	YAEV1C-L3	--	--	--	RH9751	--

NOTE: Component manufactures' and OEM instructions shall take precedence over the information presented in these charts. Wire ranges are for reference only.

HD002 TOOL OPTIONS

HH80C Hand Tool, p. 114
TBHD1M Pneumatic Tool, p. 114

HD36 TOOL SERIES OPTIONS

HD36 Hand Tool, p. 109
HDE36B Battery Tool, p. 110
EHCD36 Electric Hydraulic Tool, p. 111

HD51 TOOL SERIES OPTIONS

HD51 Hand Tool, p. 112
XHD51 Pneumatic Tool, p. 112

MS25036-132 TO -141, Sizes 1/0 TO 4/0



Similar Terminal Shown

TYPE: Class 1 Insulated Terminals
INSULATION: Nylon, UL 94V-2
TERMINAL BODY & SLEEVE: Copper, ASTM B-152
PLATING: Tin, ASTM B-545
MAX TEMP RATING: 105° C

Tool Selection Guide*

TERMINAL SPECS					DMC TOOL/DIE OPTIONS			
AWG	WIRE SIZE MM	INSULATION DIAMETER IN. (MM)	SLEEVE COLOR	TERMINAL/SPLICE PART NUMBER	HD002 DIES MIL APPROVED*	HD51 SERIES		
1/0	42.4-60.6	.632 (16.05)	Blue	MS25036-	132	HD002-01 Die	HD51-128 Die	
					133	HD002-01 Die	HD51-128 Die	
					134	HD002-01 Die	HD51-128 Die	
2/0	60.6-76.3	.684 (17.37)	Yellow	MS25036-	135	HD002-02 Die	HD51-129 Die	
					136	HD002-02 Die	HD51-129 Die	
					137	HD002-02 Die	HD51-129 Die	
3/0	76.3-96.3	.737 (18.72)	Red	MS25036-	138	HD002-03 Die	--	
					139	HD002-03 Die	--	
4/0	96.3-117	.799 (20.29)	Blue	MS25036-	140	HD002-04 Die	--	
					141	HD002-04 Die	--	

* If MIL Approval is required, QPL status should be verified. Consult DMC for current status.

Terminal Manufacturers' Part Numbers

TERMINAL SPECS			TERMINAL MANUFACTURERS' TERMINAL #						
AWG	SLEEVE COLOR	TERMINAL/SPLICE PART NUMBER	BURNDY	HOLLINGSWORTH	MOLEX	PANDUIT	THOMAS&BETTS	TYCO ELEC	
1/0	Blue	MS25036-	132	YAEV25-L1	--	--	--	RJ9711	--
			133	YAEV25-L	--	--	--	RJ9731	--
			134	YAEV25-L3	--	--	--	RJ9751	--
2/0	Yellow	MS25036-	135	YAEV26-L2	--	--	--	RK9711	--
			136	YAEV26-L	--	--	--	RK9731	--
			137	YAEV26-L3	--	--	--	RK9751	--
3/0	Red	MS25036-	138	--	--	--	--	RL9731	--
			139	--	--	--	--	RL9751	--
4/0	Blue	MS25036-	140	--	--	--	--	RM9731	--
			141	--	--	--	--	RM9751	--

NOTE: Component manufactures' and OEM instructions shall take precedence over the information presented in these charts. Wire ranges are for reference only.

HD002 TOOL OPTIONS

HH80C Hand Tool, p. 114
 TBHD1M Pneumatic Tool, p. 114

HD51 TOOL SERIES OPTIONS

HD51 Hand Tool, p. 112
 XHD51 Pneumatic Tool, p. 112



Similar Terminal Shown

MS25036-143 TO -151, Sizes 26 TO 18

TYPE: Class 1 Insulated Terminals

INSULATION: Nylon, UL 94V-2

TERMINAL BODY & SLEEVE: Copper, ASTM B-152

PLATING: Tin, ASTM B-545

MAX TEMP RATING: 105° C

Tool Selection Guide*

TERMINAL SPECS					DMC TOOL/DIE OPTIONS					
AWG	WIRE SIZE MM	INSULATION DIAMETER IN. (MM)	SLEEVE COLOR	TERMINAL/SPLICE PART NUMBER	HX4 SERIES MIL APPROVED*	HX3 SERIES MIL APPROVED*	MIL APPROVED* TOOL	HX4 SERIES SINGLE CAVITY	HX4 SERIES MULTI CAVITY	
#26-24	0.12 - 0.24	.082 (2.09)	Yellow	MS25036-	143	Y501 Die	X511 Die	M22520/40-01	Y672 Die	Y1060 Die
					144	Y501 Die	X511 Die	M22520/40-01	Y672 Die	Y1060 Die
					145	Y501 Die	X511 Die	M22520/40-01	Y672 Die	Y1060 Die
					146	Y501 Die	X511 Die	M22520/40-01	Y672 Die	Y1060 Die
					147	Y501 Die	X511 Die	M22520/40-01	Y672 Die	Y1060 Die
#22-18	0.26- 0.96	.125 (3.18)	Red	MS25036-	148	Y501 Die	X511 Die	M22520/40-01	Y672 Die	Y1060 Die
					149	Y501 Die	X511 Die	M22520/40-01	Y672 Die	Y1060 Die
					150	Y501 Die	X511 Die	M22520/40-01	Y672 Die	Y1060 Die
					151	Y501 Die	X511 Die	M22520/40-01	Y672 Die	Y1060 Die

* If MIL Approval is required, QPL status should be verified. Consult DMC for current status.

Terminal Manufacturers' Part Numbers

TERMINAL SPECS			TERMINAL MANUFACTURERS' TERMINAL #						
AWG	SLEEVE COLOR	TERMINAL/SPLICE PART NUMBER	BURNDY	HOLLINGSWORTH	MOLEX	PANDUIT	THOMAS&BETTS	TYCO ELEC	
#26-24	Yellow	MS25036-	143	--	XR26336 N	--	--	RAX23	54310-1
			144	--	XR26337 N	--	--	RAX43	52189
			145	--	XR26338 N	--	--	RAX63	53073
			146	--	XR26339 N	--	--	RAX83	54311-1
			147	--	XR26340 N	--	--	RAX103	54321-1
#22-18	Red	MS25036-	148	YAES18-N48	XR1880 SN	AA-820-04	PN18-4RN	RA323	31880
			149	YAES18-N49	XR1890 SN	AA-821-08	PN18-8R	RA863	31890
			150	YAES18-N50	XR1894 SN	AA-822-14	PN18-14R	RA713	31894
			151	--	--	--	--	RA753	328975

NOTE: Component manufactures' and OEM instructions shall take precedence over the information presented in these charts. Wire ranges are for reference only.

HX4 TOOL SERIES OPTIONS FOR Y-DIES

HX4 Hand Tools, p. 70 & 75
 HXE4B, HXE4-R Battery Tools, p. 72 & 73
 HX23 Pneumatic Tool, p. 74
 EHCY Electric Hydraulic Tool, p. 76

HX3 TOOL SERIES OPTIONS FOR X-DIES

HX3 Hand Tools, p. 70 & 75
 PHX3 Pneumatic Tool, p. 75

MS25036-152 TO -159, Sizes 22 TO 10



Similar Terminal Shown

TYPE: Class 1 Insulated Terminals
INSULATION: Nylon, UL 94V-2
TERMINAL BODY & SLEEVE: Copper, ASTM B-152
PLATING: Tin, ASTM B-545
MAX TEMP RATING: 105° C

Tool Selection Guide*

TERMINAL SPECS					DMC TOOL/DIE OPTIONS					
AWG	WIRE SIZE MM	INSULATION DIAMETER IN. (MM)	SLEEVE COLOR	TERMINAL/SPLICE PART NUMBER	HX4 SERIES MIL APPROVED*	HX3 SERIES MIL APPROVED*	MIL APPROVED* TOOL	HX4 SERIES SINGLE CAVITY	HX4 SERIES MULTI CAVITY	
#16-14	1.04 - 2.62	.150 (3.81)	Blue	MS25036-	152	Y501 Die	X511 Die	M22520/40-01	Y671 Die	Y1060 Die
					153	Y501 Die	X511 Die	M22520/40-01	Y671 Die	Y1060 Die
					154	Y501 Die	X511 Die	M22520/40-01	Y671 Die	Y1060 Die
					155	Y501 Die	X511 Die	M22520/40-01	Y671 Die	Y1060 Die
#12-10	2.62 - 6.64	.230 (5.84)	Yellow	MS25036-	156	Y501 Die	X515 Die	--	Y670 Die	--
					157	Y501 Die	X515 Die	--	Y670 Die	--
					158	Y501 Die	X515 Die	--	Y670 Die	--
#22-18	0.26-0.96	.230 (5.84)	Red	MS25036-	159	Y501 Die	X511 Die	M22520/40-01	Y672 Die	Y1060 Die

* If MIL Approval is required, QPL status should be verified. Consult DMC for current status.

Terminal Manufacturers' Part Numbers

TERMINAL SPECS			TERMINAL MANUFACTURERS' TERMINAL #						
AWG	SLEEVE COLOR	TERMINAL/SPLICE PART NUMBER	BURNDY	HOLLINGSWORTH	MOLEX	PANDUIT	THOMAS&BETTS	TYCO ELEC	
#16-14	Blue	MS25036-	152	YAES14N52	--	BB-823-04	PN14-4R	RB1323	324159
			153	YAES14N53	XR1902 SN	BB-837-08	PN14-8R	RB863	51864-1
			154	YAES14N54	XR1906 SN	BB-825-14	PN14-14R	RB713	320563
			155	YAES14N55	--	--	--	RB753	328976
#12-10	Yellow	MS25036-	156	YAES10-N56	XR5108 N	C-828-08	PN10-8R	RC863	35108
			157	YAES10-N57	XR5110 N	C-830-14	PN10-14R	RC713	35110
			158	YAES10-N58	XR5117 N	--	--	RC753	52077
#22-18	Red	MS25036-	159	--	XR1879 SN	AA-820-02	--	--	

NOTE: Component manufactures' and OEM instructions shall take precedence over the information presented in these charts. Wire ranges are for reference only.

HX4 TOOL SERIES OPTIONS FOR Y-DIES

HX4 Hand Tools, p. 70 & 75
 HXE4B, HXE4-R Battery Tools, p. 72 & 73
 HX23 Pneumatic Tool, p. 74
 EHCY Electric Hydraulic Tool, p. 76

HX3 TOOL SERIES OPTIONS FOR X-DIES

HX3 Hand Tools, p. 70 & 75
 PHX3 Pneumatic Tool, p. 75

Hand Held Pneumatic Wire Stripping Tool

Compact Design allows hand-held tool to be used in confined areas.

Light Weight construction and pneumatic actuation system minimize operator fatigue and carpal tunnel injuries.

Fast, smooth stripping operation results in maximum quality wire preparation at a production rate unattainable with hand operated mechanical strippers.

Compatibility with common, commercially available stripper blades (see page 165), grippers, and other components makes the unit economical, and it assured a wide range of applications with all types of wire.

Rotatable Head permits left or right hand operation.

Wire Stop may be used for precise, repeatable operations.

Adjustable Speed Control allows the operator to regulate the speed of the stripping operation by simply rotating the adjustment collar which is a part of the air hose. This enables greater accuracy and control of the wire stripper.

The WSP-1630 series Pneumatic Wire Stripper is the ultimate combination of performance, reliability, and portability. It was developed in cooperation with major aerospace contractors addressing their needs for a reliable, simple to

operate pneumatic wire stripper utilizing the blades and accessories which are certified and inventoried within their existing facilities.

The WSP-1630 part number applies to the basic pneumatic wire stripper frame with L-5211 blades (less accessories), which accommodates most size 16 AWG and smaller wires. Blades, pads and accessories to cover a variety of wire types and sizes are available (see page 165). Consult DMC for designated part numbers for wire strippers with blades, pads and alternate components. Please contact DMC for specific details about this and other wire stripping products.

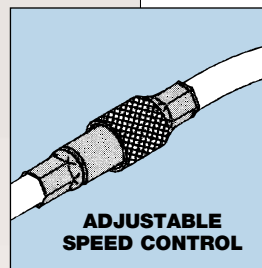
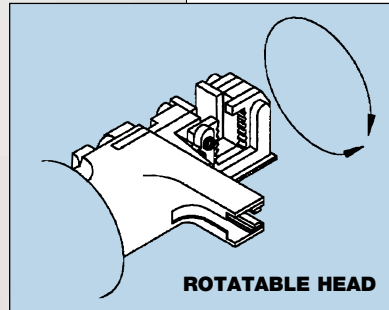

The Industry Standard for Wire Strippers (AS5768, Tool, Stripper, Electrical Insulation, General Specification For) was developed to organize, define, and provide QPL source management for wire strippers and blades used in Aerospace and Commercial applications. The AS5768 Specification is available from www.SAE.org.

AS5768 WIRE STRIPPER BLADE PART NUMBER TABLE			
SAE SPEC TOOL PART NUMBER	WIRE TYPE	WIRE SIZE CAVITIES	NSN
AS5768-1-B1	AS50861/1, /2, /4-/7	10-14	NA
AS5768-1-B2	AS50861/1, /2, /4-/7	16-22	NA
AS5768-1-B3	AS22759/5, /6	16-22	5110-01-377-2272
AS5768-1-B4	AS22759/7, /8	16-22	5110-01-377-2237
AS5768-1-B5	AS22759/9-/12, /16, /17, /20-/23, /28-/35, /41-/46, AS81044/11-/13, AS85465/9-/12, MIL-DTL-81381/3, /4	10-14	5110-01-373-2486
AS5768-1-B6	AS22759/9-/12, /20-/23, /28-/31	16-26	5110-00-177-7286 5110-01-3772-181
AS5768-1-B7	AS22759/9-/12, 20-/23, /28-/31, /34, /35, /41-/43, AS81044/7-/14, /21, /22, MIL-DTL-81381/3, /4, /7-/14, /21, /22	26-30	5110-00-177-7287
AS5768-1-B8	AS22759/11, /12, /16, /17, MIL-DTL-81381/11-/14, /22	16-26	5110-01-377-2245
AS5768-1-B9	AS22759/16, /17, /32-/35, /41-/46	16-26	5110-01-373-2487
AS5768-1-B10	AS22759/18, /19, MIL-DTL-81381/1, /2, /5-/10, /21	16-26	5110-01-377-2271
AS5768-1-B11	AS22759/18, /19, MIL-DTL-81381/11-/14, /22	10-14	5110-01-377-2313
AS5768-1-B12	AS22759/80-/82, /91, /92	10-14	5110-01-520-8380
AS5768-1-B13	AS22759/80-/82, /91, /92	16-24	NA
AS5768-1-B14	AS22759/83-/90	10-14	NA
AS5768-1-B15	AS22759/83-/90	16-26	5110-01-520-8379 5110-01-530-2382
AS5768-1-B16	AS81044/5-/7	10-14	5110-01-380-9356
AS5768-1-B17	AS81044/5-/7	16-26	5110-01-373-2484
AS5768-1-B18	AS81044/8-/10	10-14	5110-01-377-2167
AS5768-1-B19	AS81044/8-/10	16-26	5110-01-377-2180
AS5768-1-B20	AS81044/11-/13, AS85485/9-/12	16-26	5110-00-088-1598 5110-01-373-2485
AS5768-1-B21	MIL-DTL-81381/1, /2, /5-/10, /17-/21	10-14	5110-01-380-9344
AS5768-1-B22	MIL-DTL-81381/17-/20	16-26	NA
AS5768-1-B23	AS85485/5-/8	10-14	5110-01-380-9387
AS5768-1-B24	AS85485/5-/8	16-26	5110-01-377-2247

DMC also offers Qualified Products Listed (QPL) Hand Operated Wire Strippers and Blades to cover a wide variety of wire types. Consult DMC for details.

ST825 Swaging Tool for Cable (wire rope)



The DMC **ST825** Swaging Tool is used to swage terminals to flexible aircraft cable (usually stainless steel) and is built to meet government specifications. The complete tool consists of a cylinder and yoke assembly that is easily accessible for quick changing of dies, air hose assembly with a shut off valve and a single action foot control valve assembly with lubricator and air filter.

All swaging and cutting dies are of a hardened steel and are polished and heat treated to withstand high impact. Each die is marked to indicate the type and size terminal to be swaged, or cable to be cut.

This rugged tool, minus the dies, weighs less than 20 pounds. It operates on standard shop air pressure of 80 to 120 PSI and is designed for hand operation or it can be mounted to cushion base plate for bench top use.

This tool is also offered in the form of a tool kit (PIN **DMC99**). This includes additional items such as a base plate, gages, the complete range of cutting and swaging dies and instruction manual. All packaged in a durable metal carrying case.

TYPICAL SWAGING APPLICATIONS

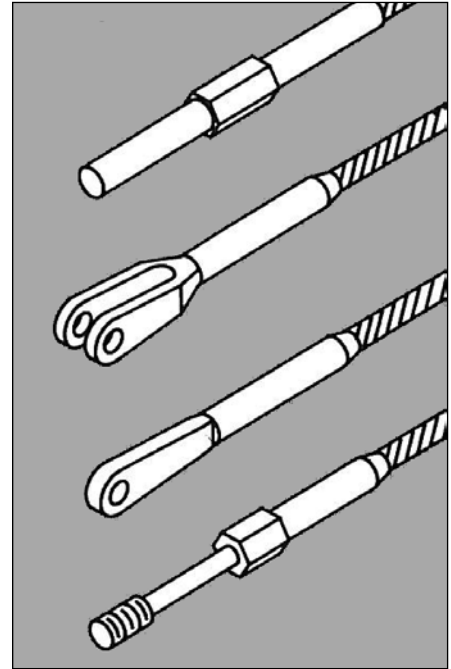

ST825 Swaging Tool for Cable (wire rope)



ST825 WITH SWAGING DIES



ST825 WITH CUTTING DIES



DMC99 TOOL KIT

The DMC99 TOOL KIT is a custom metal tool kit and carrying case for the Swaging tool and includes additional items such as a base plate, gages, cutting and swaging dies and instruction manual. This tool kit meets federal specification GGG-S-00825A (GSA-FSS) NSN 5130-00-712-4855.

TO BE USED ON MIL-W-83420, MIL-W-87161 AND SPECIFIED WIRES.

DMC PART NO.	QTY.	TERMINAL REF. (MIL.#)	DESCRIPTION	CABLE DIA.	CROSS REF. ATI P/N
G689	1		GAGE SET		AT5205G
ST825003	1		SPACER		AT520SP-1
ST825SDB-2	2	MS20663-2	SWAGING DIE	1/16"	AT520CDB-2
ST825SDB-3	2	MS20663-3	SWAGING DIE	3/32"	AT520CDB-3
ST825SDB-4	2	MS20663-4	SWAGING DIE	1/8"	AT520CDB-4
ST825SDB-5	2	MS20663-5	SWAGING DIE	5/32"	AT520CDB-5
ST825SDB-6	2	MS20663-6	SWAGING DIE	3/16"	AT520CDB-6
ST825SSB-2-L	1	MS20664-2 (L)	SWAGING DIE , LEFT	1/16"	
ST825SSB-2-R	1	MS20664-2 (R)	SWAGING DIE , RIGHT	1/16"	*AT520CSB-2
ST825SSB-3-L	1	MS20664-3 (L)	SWAGING DIE , LEFT	3/32"	
ST825SSB-3-R	1	MS20664-3 (R)	SWAGING DIE , RIGHT	3/32"	*AT520CSB-3
ST825SSB-4-L	1	MS20664-4 (L)	SWAGING DIE, LEFT	1/8"	
ST825SSB-4-R	1	MS20664-4 (R)	SWAGING DIE, RIGHT	1/8"	* AT520CSB-4
ST825SSB-5-L	1	MS20664-5 (L)	SWAGING DIE , LEFT	5/32"	
ST825SSB-5-R	1	MS20664-5 (R)	SWAGING DIE, RIGHT	5/32"	*AT520CSB-5
ST825SSB-6-L	1	MS20664-6 (L)	SWAGING DIE, LEFT	3/16"	
ST825SSB-6-R	1	MS20664-6 (R)	SWAGING DIE , RIGHT	3/16"	*AT520CSB-6
ST825SB-2	2	BA3-2	SWAGING DIE	1/16"	AT520CB-2
ST825SB-3	2	BA3-3	SWAGING DIE	3/32"	AT520CB-3
ST825SB-4	2	BA3-4	SWAGING DIE	3/32"	AT520CB-4
ST825SL-2	2	** -2	SWAGING DIE	1/16"	AT520CS-2
ST825SL-3	2	** -3	SWAGING DIE	3/32"	AT520CS-3
ST825SL-4	2	** -4	SWAGING DIE	1/8"	AT520CS-4
ST825SL-5	2	** -5	SWAGING DIE	5/32"	AT520CS-5
ST825SL-6	2	** -6	SWAGING DIE	3/16"	AT520CS-6
ST825SL-7	2	** -7 (NOTE)	SWAGING DIE	7/32"	AT520CS-7
ST825SL-8	2	** -8	SWAGING DIE	1/4"	AT520CS-8
ST825CD-2-1	1		CUTTING DIE	1/16"	AT520CD-2
ST825CD-2-2	1		CUTTING PUNCH	1/16"	AT520CP-2
ST825CD-3-1	1		CUTTING DIE	3/32"	AT520CD-3
ST825CD-3-2	1		CUTTING PUNCH	3/32"	AT520CP-3
ST825CD-4-1	1		CUTTING DIE	1/8"	AT520CD-4
ST825CD-4-2	1		CUTTING PUNCH	1/8"	AT520CP-4
ST825CD-5-1	1		CUTTING DIE	5/32"	AT520CD -5
ST825CD-5-2	1		CUTTING PUNCH	5/32"	AT520CP-5
ST825CD-6-1	1		CUTTING DIE	3/16"	AT520CD-6
ST825CD-6-2	1		CUTTING PUNCH	3/16"	AT520CP-6
ST825CD-7-1	1		CUTTING DIE	7/32"	AT520CD-7
ST825CD-7-2	1		CUTTING PUNCH	7/32"	AT520CP-7
ST825CD-8-1	1		CUTTING DIE	1/4"	AT520CD-8
ST825CD-8-2	1		CUTTING PUNCH	1/4"	AT520CP-8

*Sets only

**MS20658, MS20667, MS2160, MS21259

(NOTE) Uses the ST825SL-6 die set for MS20658-7 terminal.

Wiring System Service Kits

HERE IS WHERE DMC'S KNOWLEDGE AND EXPERIENCE PAY OFF!

Building a tool kit to service an entire wiring system involves extensive research to select to correct tooling and ensure all serviceable connectors, terminals, splices and contacts are covered. Technicians who are responsible for the maintenance or production of entire systems cannot be expected to know all the answers, nor do they have the time to do the necessary research or locate tooling. DMC has this knowledge and does the technical research for them.

We apply our decades of connector industry experience and wealth of tooling information into developing the technical data for every Wiring System Service Kit we build.

We design and manufacture a tool kit package which includes:

- 1) All the necessary tooling (crimping tools, dies, heads, installing tools, removal tools, gages, wire strippers for circular and R.F. connectors and more).
- 2) Complete instructions on set up and use of each tool and accessory.
- 3) Valuable tool application data which eliminates guesswork and dangerous trial and error tool selection.



DMC has built Wiring System Service Kits for over 40 years and already has tool kits designed for most Military Aircraft & Ground Vehicles, Commercial Aircraft, Commuter and Executive Aircraft, Helicopters, as well as for individual Shipboard Systems, Weapons Systems and Avionics Systems. DMC kits have become the standard for wiring system maintenance.

We can assist you with the selection or custom design the right Wiring System Service Kit to meet your individual requirements.

After you have purchased a DMC Wiring System Service Kit, our trained personnel are available with the information and tools you need to keep your kit up-to-date.



MILITARY STANDARD KITS

These kits are specified by many departments of the government, particularly the Navy and Air Force. They conform to MIL-M-83521, MIL-T-83507, and others. The national stock class code for most of the Military Standard Kits is usually 5120 or 5180.

AIRCRAFT OR SYSTEM KITS

We produce Wiring System Service Kits for a wide range of individual aircraft, families of aircraft, and mixed fleets. We can custom design or alter an existing kit to meet the user's requirements.

Some common aircraft covered are:

Airbus A300, A310, A320, A330, A340, A380
Bell 205, 206, 206L, 212, 412, 430
Boeing 707, 727, 737s, 747s, 757, 767, 777
Bombardier CRJ series, DASH 8s, CL-600 to 604
Cessna Citation I, II, III IV, V, VI, VII & X
Dassault FALCON 10/100, 20/200, 50/900, 50EX, 900EX & 2000/2000EX
Douglas DC8, DC9 and DC10
Embraer EMB-110, -120, -312, ERJ-135, -145, -170, -190 & Legacy
Eurocopter EC-135, EC-145, BO-105, BK-117
Fokker F50/F100
Gulfstream II, III, IV, V, G550
Hawker Beechcraft 800/800XP, 1900D, King Air 200, 200T, 350
Learjet 25, 31A, 35, 45, 55, & 60
Pilatus PC-12 & PC-7 Trainer
Sikorsky S-76, S-92
And many more...

Contact DMC, or visit our Web site, for a list of Aircraft and Systems covered by DMC Wiring System Service Kits.



GENERAL AVIATION KIT

The DMC1149 General Aviation Kit was developed for, and in conjunction with, organizations involved in the maintenance and outfitting of light commercial, business, and personal aircraft. It has since proven to be well suited for service of many types of other systems.



This basic kit covers the standard power contacts sizes 16, 20, and 22D in the following connector families.

MIL-DTL-24308	MIL-DTL-83723
MIL-DTL-26482	Deutsch DS Series
MIL-DTL-26500	ITT Cannon DPX and
MIL-PRF-38999	DC Series

Also covered are stamped formed contacts used in many general purpose connectors supplied by: AMP, Elco, Winchester, Collins Narco, Bendix, King, Sperry, etc. Plus necessary tooling to cover most common types of RF connectors (i.e. BNC, TNC) using RG/58 and RG/8 coaxial cable. Experience in the field has shown these to be the most common variety. (See technical application tables elsewhere in the catalog for specific descriptions and contact P/N for military designations.)

We cannot guarantee this kit will solve all your connector maintenance problems, but the necessary tooling and information will certainly be at hand for most requirements. (Our engineering department will confirm coverage of your specific requirements.)

The durable steel case provides strength and light weight. The tools are restrained in protective foam cavities.

PRODUCTION (WORK STATION) KITS

DMC work stations are custom designed to fit your production requirements. They can utilize hand tools or pneumatic models. Special holding clamps or work positioners can be included in the container or mounted permanently to the tooling enclosure. Our engineering department can give you details on the best work station for your application.

BACKSHELL ACCESSORY KITS

DMC produces a variety of innovative tools and adaptors which are used when fitting backshell or strain-relief hardware to electrical connectors. (Ask for our BETA Backshell Tooling Guide.) These tools are available in sets according to connector series or in complete system support tool kits. The kits can be individually designed to meet your maintenance or production demands.

Wiring System Service Kits

VALUABLE DATA PACKAGES

THE MAINTENANCE PROBLEM

Today's sophisticated aircraft, defense systems, and avionics electronics have become increasingly more complex. The technician who must maintain these systems cannot possibly be knowledgeable about all the various types of terminations and associated tooling needed to repair the vast number of interconnections which make up these systems.

Once the system becomes inoperative, the pressure to return the system to operation does not permit the luxury of researching the answers to these tooling complexities.

THE MAINTENANCE SOLUTION

Tool Selection Charts DMC does all the necessary research to relieve this pressure and eliminate the guesswork and haphazard, trial-and-error selection of tools by developing detailed Tool Selection Charts to cross reference all the connectors with vital repair tool data. These charts identify the connectors in alpha/numeric order by their military and/or commercial designations; identify the contacts by part number and color code where applicable; list applicable wire sizes; and identify the appropriate crimp tool and associated turret/positioner/die, installing tool and removal tool for wired and unwired contacts where applicable.

Instruction Sheets DMC provides detailed step-by-step directions on how to prepare a tool for use, crimp contacts, install and remove contacts, strip wire, and gauge tools and contacts. Instruction Sheets are also available to meet foreign language or unique special purpose tool requirements.

Contents Charts These charts offer a visual representation of the storage compartments for all tools in the kit. The Contents Charts list the tools by part number, so the location of all tools and reordering information is immediately available should a component require replacement.

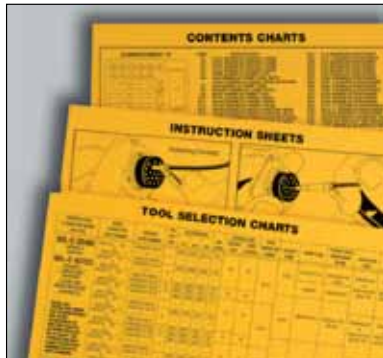

Packaging. DMC then packages these Tool Selection Charts, Contents Charts, and Instruction Sheets with all the crimping tools, turrets, dies, wire strippers, installing tools, removal tools and other accessories necessary to support the system in durable cases tailored to the expected work environment so the tools are properly organized and protected.

With a DMC Wiring System Service Kit, the technician now has ready access to the technical data and tools for reliable, cost-effective Total Wiring System Support.

KIT CONSTRUCTION

FOAM INSERTS

Foam inserts (standard for all DMC kits) provide each component with a designated storage space which is indicated on the Contents Charts. This assures the technician that no needed components are missing prior to departing to make the repair. The technician also knows, prior to leaving the on-site repair, that if a compartment is empty, then a component is missing and must be retrieved. This helps eliminate FOD (Foreign Object Damage) and accountability.



COLORED BASE LAYERS & LABELING (OPTIONAL)

Colored base layers are available to highlight tool cavities and aid with tool tracking. Cavity Labeling is also available to help identify tool cavities and make returning tools to the proper place simpler.



CAVITY LABELING

COLORED BASE LAYERS

CALIBRATION, INSPECTION, AND OVERHAUL/REPAIR FOR TOOL KITS

DMC is available to overhaul and repair existing Wiring System Service Kits or periodic inspection & calibration. We'll repair cases when possible and replace or upgrade foam cavities as needed. We inspect & calibrate all tooling and determine if repairs need to be made. We also identify and replace missing tools, charts, & tool instructions. Contract DMC Customer Service for an estimate or more information.



ENVIRONMENTAL PACKAGING

An analysis of the environmental conditions the kit must endure is an absolute necessity.

Our "Portable" kits are designed for on-site field maintenance. Maximum portability and component protection are the controlling design factors for portable kits. They are supplied in a durable case constructed of metal, fiberglass, or ultra-high impact copolymer. A captive restraint mechanism and heavy duty hardware are generally utilized to secure tools within their cavities.



REINFORCED CORNERS (OPTIONAL)

Fiberglass and high-impact copolymer cases are equipped with gaskets to protect against moisture intrusion. Fiberglass cases designated for ground vehicles even have steel reinforced corners.

Our "Roll Around Cabinet" kits are designed for FBO depot-level workshop maintenance. These kits are designed and packaged for security and convenient location of components. Depot-level cabinets are constructed of steel and have built in locks. They are equipped with roller drawer slides and wheels to allow them to roll around the work-shop or hanger, or can be loaded for easy deployment.

Regardless of packaging, all reference charts are laminated for protection against the elements.



CUSTOM SIZES

The tools and technical data can be packaged in various configurations: from a single metal tool box to a few portable cases to a multi-drawer, roll-around cabinet.

The same kit can be reorganized and reconfigured to serve different purposes. A single portable tool kit can be expanded into a larger cabinet by providing cavities for non-wiring related tools, or a single depot-level cabinet can be broken down into multiple portable cases.

Limited Warranty*

LIMITED WARRANTY*

Daniels Manufacturing Corporation warrants each new unit sold by it to be free from defects in material and workmanship under normal use and service. Its obligation under this warranty is limited to the free correction or, at its option, the refund of the purchase price of any such unit which proves defective within ninety (90) days after delivery to the first user, provided that the unit is returned to it with all transportation charges prepaid and which shall appear to its satisfaction, upon inspection by it, to have been defective

in material or workmanship. This warranty shall not cover any damage to such products, which in the opinion of Daniels Manufacturing Corporation, was caused by normal wear, misuse, improper operation or accident.

DANIELS MANUFACTURING CORPORATION IS NOT LIABLE FOR CONSEQUENTIAL OR SPECIAL DAMAGES OF ANY NATURE OR KIND RESULTING FROM THE USE OF ANY OF ITS PRODUCTS. This warranty is in lieu of all other warranties express or implied. No warranty, express or implied, is made or authorized to be made or assumed with respect to products of Daniels Manufacturing Corporation, other than that herein set forth.

* as defined by PL93-637



ERGONOMICS CHALLENGE

Ergonomic guidelines set for less demanding and mechanically complicated hand tools (such as hammers, wrenches, wire cutters and pliers) cannot be applied to crimping tools which require thousands of pounds of force.

DMC's years of experience as a leader in the crimp tool industry, have confirmed that the most effective ergonomic improvements for workers can be achieved by substituting power assisted crimp tools for existing hand crimp tools wherever feasible. DMC's pneumatic, hydraulic, and battery operated power assisted crimp tools are already supporting OEM Production Line Operations where crimping is being done 24/7.

For hand crimp tools, DMC's ergonomic philosophy is to design the most mechanically efficient hand crimp tool linkage possible and to fit the hand crimp tools with comfortable grips and handle shapes, thereby producing ergonomic hand crimp tools with the same quality, precision and repeatability that have become synonymous with the DMC name.

The solution to the Ergonomics Challenge is to provide power assisted crimp tools for all crimping operations of sufficient volume where the user will see the value of ergonomic benefits.



X-ON Electronics

Largest Supplier of Electrical and Electronic Components

Click to view similar products for [Hand Tools](#) category:

Click to view products by [Daniels](#) manufacturer:

Other Similar products are found below :

[568681-1](#) [576786-2](#) [58061-1](#) [58176-1](#) [58177-1](#) [58177-2](#) [58284-1](#) [59085](#) [0031](#) [59737-5](#) [015-0339-000](#) [015-8755-001](#) [600-146-06](#) [M15570-25](#) [62200-5709](#) [6-304052-1](#) [63443-1002](#) [63443-3513](#) [63443-4025](#) [63443-7114](#) [6-354778-5](#) [6-354779-2](#) [63600-2995](#) [63810-0105](#) [M8196914-08](#) [M819698-07](#) [662508-1](#) [662908-1](#) [679994-1](#) [679994-2](#) [68764-0001](#) [69001-0105](#) [69002-5525](#) [690124-7](#) [690191-1](#) [690191-4](#) [690696-1](#) [691409-4](#) [691667-1](#) [692006-2](#) [692655-7](#) [692776-1](#) [692776-4](#) [693077-3](#) [693077-4](#) [693597-1](#) [D20418-137](#) [D20419-189](#) [ESR-17x17](#) [ET-LY10](#)