

NX-Series Modular I/O System

Connecting to Open Industrial Network Standards

EtherNet/IP™

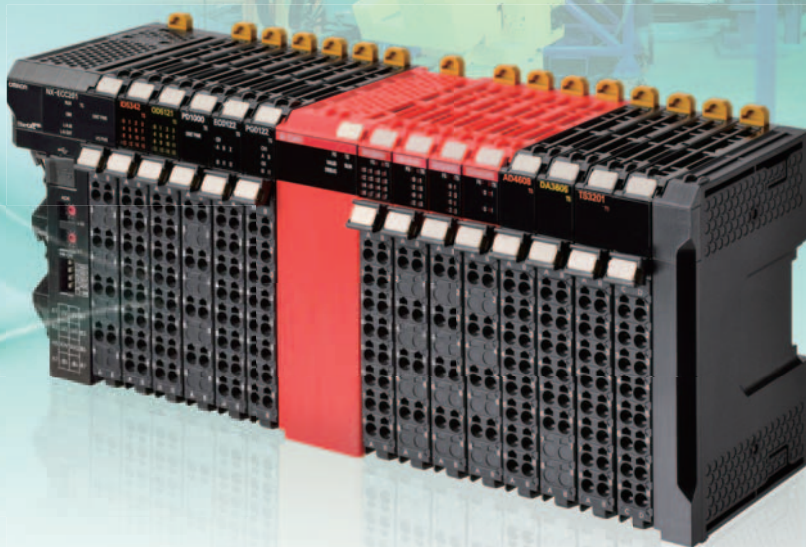

» Choice of functionality and performance.

» Integration of Standard I/O and Safety

» Intuitive and efficient safety programming with PLCopen functions

Choice of networks

The NX-series Communication Coupler Units support global open networks. Select the network that best suits your needs.

Lineup of Communication Coupler Units

EtherNet/IP Communication Coupler Unit NX-EIC202

EtherNet/IP™



EtherNet/IP uses the Common Industrial Protocol (CIP™) over a standard Ethernet infrastructure. The EtherNet/IP Coupler has a built-in Ethernet switch and two RJ45 ports, to daisy-chain I/O stations without additional hardware. Data exchange over EtherNet/IP uses data links with configurable update cycles, allowing a trade-off between performance and data capacity for each individual link.

For details on EtherNet/IP, refer to the EtherNet/IP Catalog (R150).

EtherCAT Communication Coupler Unit NX-ECC202

EtherCAT®



EtherCAT uses Ethernet as a dedicated control network. With a pure Master-Slave architecture and on-the-fly data exchange, it offers unparalleled communication efficiency.

EtherCAT's distributed real-time clock and time-stamping of I/O data help to achieve multi-axis synchronised machine control with less than 1 us jitter.

*For details, refer to the Sysmac Catalog (P072).

Windows is registered trademarks of Microsoft Corporation in the USA and other countries.

EtherCAT® is registered trademark and patented technology, licensed by Beckhoff Automation GmbH, Germany.

EtherNet/IP™ is the trademarks of ODVA.

Other company names and product names in this document are the trademarks or registered trademarks of their respective companies.

Microsoft product screen shots reprinted with permission from Microsoft Corporation.

NX Series

The NX Series is a range of modular designed units that integrate standard I/O and safety and connect to the EtherNet/IP network via Communication Coupler Units.

EtherNet/IP™



Features

1. Integrated control

Standard I/O and safety units can be mixed within an I/O station.

2. Integrated design environment

Machine and safety control can be designed using one software.

3. Conforming to IEC 61131-3 standard

IEC 61131-3 function blocks for safety control, as recommended by PLCopen, are supported.

4. Saving space

Modular design allows the minimum width of the standard I/O unit to be 12 mm.

Space can be reduced by 70% compared to the existing terminal blocks. (OMRON investigation)

INDEX

>P 4

Distributed I/O:
the choice is yours

>P 6

The Safety solution
for any application

>P 8

One I/O system
for various controllers

>P 10

System Configuration/
Configuration Unit

>P 12

EtherNet/IP Coupler Unit

Distributed I/O: the choice is yours.

The modern remote I/O demands increasing levels of flexibility.

The EtherNet/IP Communication Unit enables connection between the CJ-series or other Programmable Controller and NX-series I/O through EtherNet/IP, which expands system configuration possibilities.

Modular remote I/O systems offer flexibility in I/O configuration and a wide choice of signal types and performance levels so that every I/O station can be assembled with just the right combination without changing the control architecture. By using standard Ethernet cables and connectors, only basic tools are required to install and maintain networks.

Features

Wide choice : More than 100 types of I/O unit, from 2 to 32 points in one unit.

Compact design : Up to 16 digital signals in 12 mm width.

Safety integrated : Mix safety controllers and safety I/O's with standard I/O's.

EtherNet/IP™

EtherNet/IP

EtherNet/IP is supported by many control system vendors, and its specification is governed by the Open DeviceNet Vendors Association (ODVA). The CIP protocol has proven its reliability in DeviceNet and CompoNet installations worldwide.

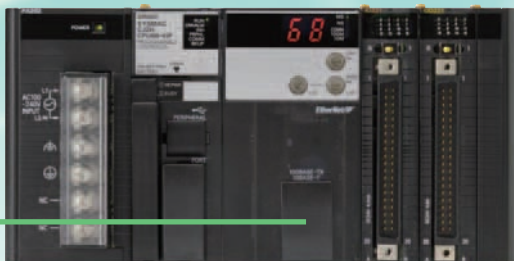

Various PLC vender like CJ series

← Up to 63 Units per communication coupler →

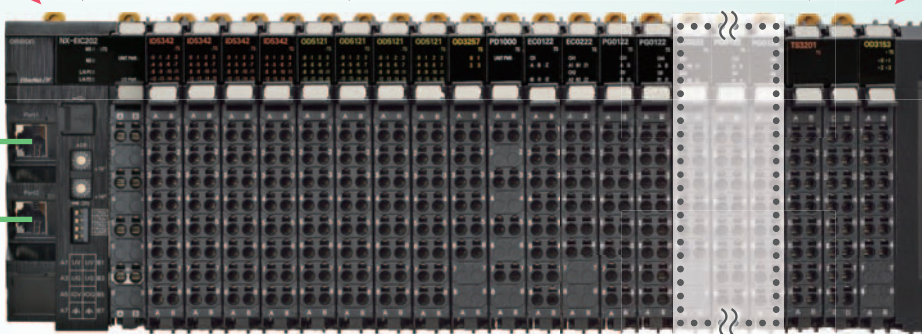

Types of standard NX I/O Units

- Digital Input/Output Units
- Analog Input/Output Units
- Temperature Input Units
- Encoder/Positioning Units
- Power supply and connection Units



Quick connections

- Detachable screwless terminal block for easy commissioning and maintenance
- Push-in connections speed up installation
- MIL connectors for high-density I/O



Safety Integrated

The NX-series safety controller and I/O units can be mixed with standard I/O's to create a complete modular safety control system.

The Safety solution for any application

As machine automation evolves the need for diversity in configurations will increase. OEM's and end-users need the ability to design highly flexibly system that have safety and can integrate with a variety of PLC's to meet the demands of evolving automation.

Features

Realize safety-related system of all machine of customer

- Flexible hardware
- Flexible Programming
- Standardization and reuse safety system
- Simplify safety system
- Ensure trouble shooting

Simulate Safety System

Offline simulator to debug safety system including feedback monitoring of safety output circuits

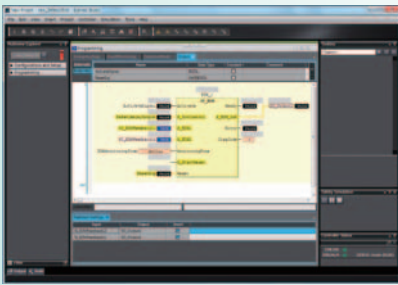

Standardization

Easy design to cover various safety options.

Flexible Programming

Powerful safety logic editor.

Ensure trouble shooting

Deliver problem analysis as Why, What, Where and Navigate How to fix.

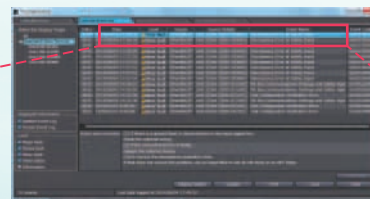

Time	Level	Source	Source Details	Event Name
2014/08/04 17:28:10	Minor fault	EtherNet/IP	Unit 3(Slot 3)(NX-SID800)	Discrepancy Error at Safety Input
2014/08/04 17:28:10	Minor fault	EtherNet/IP	Unit 3(Slot 3)(NX-SID800)	Discrepancy Error at Safety Input
2014/08/04 17:28:09	Minor fault	EtherNet/IP	Unit 3(Slot 3)(NX-SID800)	Discrepancy Error at Safety Input

Automation Software
Sysmac Studio
NX I/O Edition



Various PLC vender
like CJ series



Safety Control Units

- EN ISO13849-1 (PLe/Safety Category 4), IEC 61508 (SIL3) certified.
- 4 or 8 points per Safety Input Unit. 2 or 4 points per Safety Output Unit.
- The Safety Units can be freely allocated in any combination with standard NX I/O.

Modular design

- Small system size allows space savings in the cabinet.
- Direct Diagnostic with LED's.
- Easy wiring and easy to maintain.



Functional
Safety
Type
Approved
www.tuv.com
ID: 0600000000

ISO 13849-1, PLe

IEC 61508, SIL3

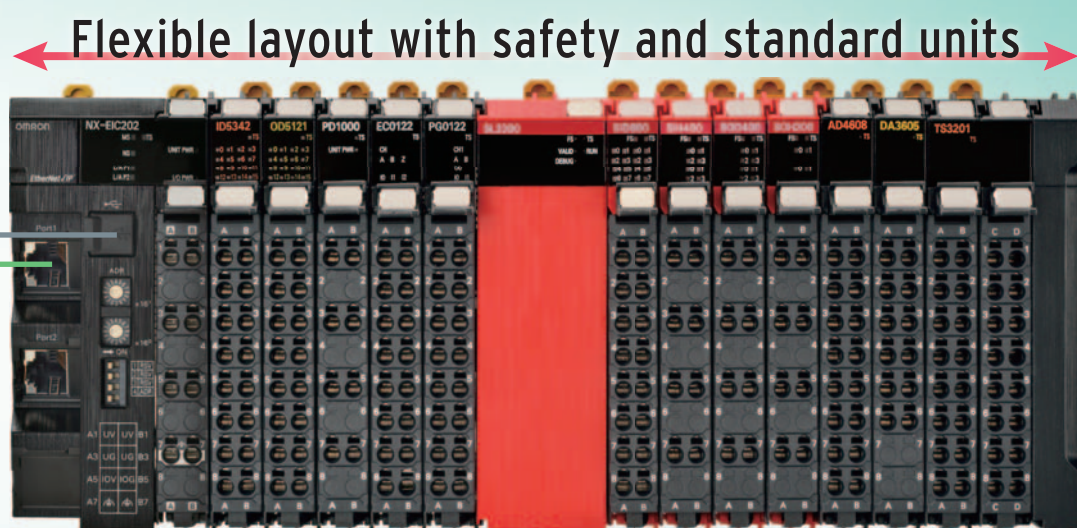

EtherNet/IP

Connecting directly to most safety components



One I/O system for various controllers.

While different machines may require different levels of controller performance, NX-series is the only remote I/O system you will need. This will unify wiring and installation techniques, and simplify spare parts stock. Safety control programs that are created using the NX I/O Edition can be standardized and reused throughout the machine portfolio, which will reduce the time required for development, testing and certification.

Low-end Machine



FA Integrated Tool Package
CX-One



Various PLC vnder
like CJ series

EtherNet/IP™

Stand Alone Safety System



Automation Software
Sysmac Studio
NX I/O Edition

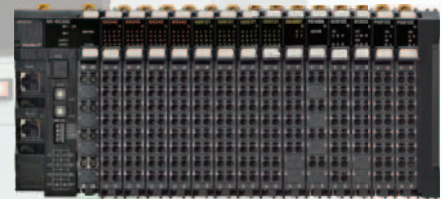

Same Manner for Safety Design
Common Software & Common
Hardware

High-performance Machine



Sysmac Studio Version 1.0

Automation Software
Sysmac Studio
Full edition



Machine Automation Controller
NJ series

EtherCAT

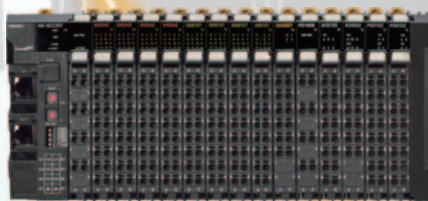

Integrated
Safety System



AC Servo motor/Driver

NX-series EtherNet/IP Coupler Unit

NX-EIC

Connecting to open industrial network standard EtherNet/IP

- The EtherNet/IP Coupler Unit is the link between the EtherNet/IP multivendor network and the NX-series I/O Units and Safety Units. With wide variety of the I/O Units and Safety Units, the NX-series is the perfect match for the CJ-series and multivendor Controllers.



Features

- Up to 63 NX-IO Units can be connected to one EtherNet/IP Coupler Unit. Standard and high-performance units can be mixed.*
 - Each Coupler plus its I/O form just a single EtherCAT node on the network.
 - I/O control and safety control can be integrated by connecting Units for safety.
 - The IP address can be found on the label on the Unit, without using software.
 - Slave configuration by Sysmac Studio can be done centrally via the controller, or on-the-spot using the Coupler's built-in USB port.
- * Input per Coupler Unit: Maximum 504 bytes, Output per Coupler Unit: Maximum 504 bytes

System Configuration

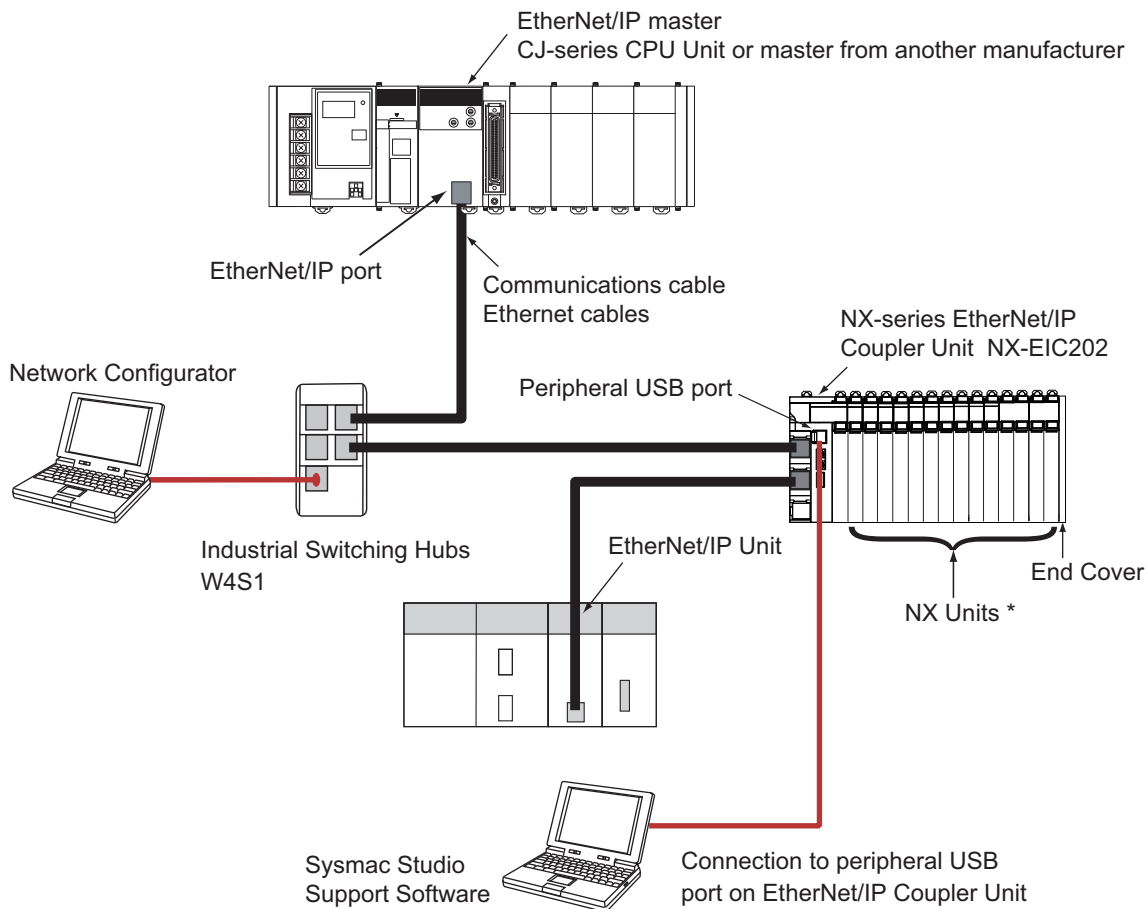

Note: Do not make a loop connection in the communications path between Ethernet switches.

* Refer to page17 for the NX Units that can be connected to the NX-series EtherNet/IP Coupler Unit.

Ordering Information

International Standards

- The standards are abbreviated as follows: U: UL, U1: UL(Class I Division 2 Products for Hazardous Locations), C: CSA, UC: cULus, UC1: cULus (Class I Division 2 Products for Hazardous Locations), CU: cUL, N: NK, L: Lloyd, CE: EC Directives, and KC: KC Registration.
- Contact your OMRON representative for further details and applicable conditions for these standards.

Unit type	Product Name	Current consumption	Maximum I/O power supply current	Model	Standards
NX Series EtherCAT Coupler Unit	EtherNet/IP Coupler Unit 	1.60 W or lower	10 A	NX-EIC202	UC1, CE, KC

Automation Software Sysmac Studio

Please purchase a DVD and required number of licenses the first time you purchase the Sysmac Studio. DVDs and licenses are available individually. Each model of licenses does not include any DVD.

Product name	Specifications			Model	Standards
		Number of licenses	Media		
Sysmac Studio NX-I/O Edition Ver.1.□□ *1 *2	Sysmac Studio NX-I/O Edition is a limited license that provides selected functions required for EtherNet/IP Coupler settings. Because this product is a license only, you need the Sysmac Studio Standard Edition DVD media to install it.	1 license	---	SYSMAC-NE001L	---
Sysmac Studio Standard Edition Ver.1.□□ *2	The Sysmac Studio is the software that provides an integrated environment for setting, programming, debugging and maintenance of machine automation controllers including the NJ Series, EtherCat Slave, and the HMI. Sysmac Studio runs on the following OS. Windows XP (Service Pack 3 or higher, 32-bit version)/ Windows Vista (32-bit version)/Windows 7 (32-bit/64-bit version)/Windows 8 (32-bit/64-bit version)/ Windows 8.1 (32-bit/64-bit version)/ Windows 10 (32-bit/64-bit version) This software provides functions of the Vision Edition. Refer to Sysmac Catalog (P072) for details such as supported models and functions.	--- (Media only)	DVD	SYSMAC-SE200D	---









*1. The Sysmac Studio Standard Edition with license(s) (SYSMAC-SE□□□L) provides functions of the NX-I/O Edition (SYSMAC-NE001L).

*2. With the Sysmac Studio Standard Edition with license(s) (SYSMAC-SE□□□L) version 1.10 or higher, you can use the setup functions for the EtherNet/IP Coupler.

Recommended EtherNet/IP Communications Cables

Use STP (shielded twisted-pair) cable of category 5 or higher for EtherNet/IP.

Cabel with Connectors

Item	Appearance	Recommended manufacturer	Cable length(m) *1	Model
Standard type Cable with Connectors on Both Ends (RJ45/RJ45) Wire Gauge and Number of Pairs: AWG27, 4-pair Cable Cable Sheath material: LSZH *2 Cable color: Yellow *3		OMRON	0.3	XS6W-6LSZH8SS30CM-Y
			0.5	XS6W-6LSZH8SS50CM-Y
			1	XS6W-6LSZH8SS100CM-Y
			2	XS6W-6LSZH8SS200CM-Y
			3	XS6W-6LSZH8SS300CM-Y
Rugged type Cable with Connectors on Both Ends (RJ45/RJ45) Wire Gauge and Number of Pairs: AWG22, 2-pair Cable		OMRON	0.3	XS5W-T421-AMD-K
			0.5	XS5W-T421-BMD-K
			1	XS5W-T421-CMD-K
			2	XS5W-T421-DMD-K
			5	XS5W-T421-GMD-K
Rugged type Cable with Connectors on Both Ends (M12 Straight/RJ45) Wire Gauge and Number of Pairs: AWG22, 2-pair Cable		OMRON	0.3	XS5W-T421-AMC-K
			0.5	XS5W-T421-BMC-K
			1	XS5W-T421-CMC-K
			2	XS5W-T421-DMC-K
			5	XS5W-T421-GMC-K
Rugged type Cable with Connectors on Both Ends (M12 Right-angle/RJ45) Wire Gauge and Number of Pairs: AWG22, 2-pair Cable		OMRON	0.3	XS5W-T422-AMC-K
			0.5	XS5W-T422-BMC-K
			1	XS5W-T422-CMC-K
			2	XS5W-T422-DMC-K
			5	XS5W-T422-GMC-K
Rugged type Cable with Connectors on Both Ends (M12 Right-angle/RJ45) Wire Gauge and Number of Pairs: AWG22, 2-pair Cable		OMRON	0.3	XS5W-T422-AMC-K
			0.5	XS5W-T422-BMC-K
			1	XS5W-T422-CMC-K
			2	XS5W-T422-DMC-K
			5	XS5W-T422-GMC-K
Rugged type Cable with Connectors on Both Ends (M12 Right-angle/RJ45) Wire Gauge and Number of Pairs: AWG22, 2-pair Cable		OMRON	0.3	XS5W-T422-AMC-K
			0.5	XS5W-T422-BMC-K
			1	XS5W-T422-CMC-K
			2	XS5W-T422-DMC-K
			5	XS5W-T422-GMC-K
Rugged type Cable with Connectors on Both Ends (M12 Right-angle/RJ45) Wire Gauge and Number of Pairs: AWG22, 2-pair Cable		OMRON	0.3	XS5W-T422-AMC-K
			0.5	XS5W-T422-BMC-K
			1	XS5W-T422-CMC-K
			2	XS5W-T422-DMC-K
			5	XS5W-T422-GMC-K
Rugged type Cable with Connectors on Both Ends (M12 Right-angle/RJ45) Wire Gauge and Number of Pairs: AWG22, 2-pair Cable		OMRON	0.3	XS5W-T422-AMC-K
			0.5	XS5W-T422-BMC-K
			1	XS5W-T422-CMC-K
			2	XS5W-T422-DMC-K
			5	XS5W-T422-GMC-K

Note: For details, refer to Cat.No.G019.

*1 Standard type cables length 0.2, 0.3, 0.5, 1, 1.5, 2, 3, 5, 7.5, 10, 15 and 20m are available.

Rugged type cables length 0.3, 0.5, 1, 2, 3, 5, 10 and 15m are available.

*2 The lineup features Low Smoke Zero Halogen cables for in-cabinet use and PUR cables for out-of-cabinet use.

*3 Cables colors are available in blue, yellow, or Green

Optional Products

Product name	Specification				Model	Standards
Unit/Terminal Block Coding Pins	Pins for 10 Units (30 terminal block pins and 30 Unit pins)				NX-AUX02	---
Product Name	Specification				Model	Standards
	No. of terminals	Terminal number indications	Ground terminal mark	Terminal current capacity		
Terminal Block	8	A/B	Provided	10 A	NX-TBC082	---

Accessories

End Cover (NX-END01)

One End Cover is provided together with the EtherNet/IP Coupler Unit.

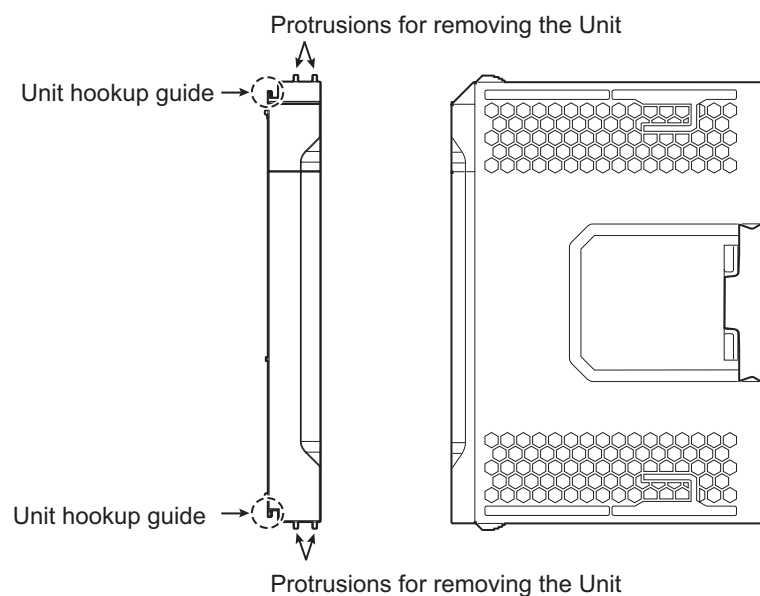

General Specification

Item		Specification
Enclosure		Mounted in a panel
Grounding method		Ground to 100 Ω or less
Operating environment	Ambient operating temperature	0 to 55°C
	Ambient operating humidity	10% to 95% (with no condensation or icing)
	Atmosphere	Must be free from corrosive gases.
	Ambient storage temperature	-25 to 70°C (with no condensation or icing)
	Altitude	2,000 m max.
	Pollution degree	Pollution degree 2 or less: Conforms to JIS B 3502 and IEC 61131-2.
	Noise immunity	Conforms to IEC 61000-4-4. 2 kV (power supply line)
	Overvoltage category	Category II: Conforms to JIS B 3502 and IEC 61131-2.
	EMC immunity level	Zone B
	Vibration resistance	Conforms to IEC 60068-2-6. 5 to 8.4 Hz with 3.5-mm amplitude, 8.4 to 150 Hz, acceleration of 9.8 m/s ² , 100 min each in X, Y, and Z directions (10 sweeps of 10 min each = 100 min total)
Shock resistance	Conforms to IEC 60068-2-27. 147 m/s ² , 3 times each in X, Y, and Z directions	
Applicable standards		cULus: Listed UL508 and ANSI/ISA 12.12.01 EC: EN 61131-2 and C-Tick

EtherNet/IP Coupler Unit Specifications

Item	Specification	
Model	NX-EIC202	
Number of connectable NX Units	63 Units max.*1	
Communications protocols	EtherNet/IP	
	UDP/IP and TCP/IP (Message Services)	
	Number of buffers (sockets): <ul style="list-style-type: none"> • 8 message buffers for server • No message buffers for client • Shared buffers for UDP/IP messages and TCP/IP messages Maximum message size: <ul style="list-style-type: none"> • Request: 492 bytes • Response: 496 bytes Maximum NX output data size: <ul style="list-style-type: none"> • 490 bytes Maximum NX input data size: <ul style="list-style-type: none"> • 496 bytes 	
Modulation	Baseband	
Link speed	100 Mbps	
Physical layer	100BASE-TX (IEEE 802.3)	
Number of connections	8	
Received Packet Interval (RPI, refresh cycle)	4 to 1,000 ms	
Allowed communications bandwidth addressing to the local node	1,000 pps	
Topology	Line, Tree, Star	
Ethernet Switch	Layer 2 Ethernet switch	
Transmission media	Category 5 or higher twisted-pair cable (Recommended cable: double-shielded cable with aluminum tape and braiding)	
Transmission distance	Distance between nodes: 100 m or less	
NX bus I/O data size	Input: 512 bytes max. (including input data, status, and unused areas) Output: 512 bytes max. (including output data and unused areas)	
EtherNet/IP I/O connection size	Input: 504 bytes max. (including input data, status, and unused areas) Output: 504 bytes max. (including output data and unused areas)	
Refreshing methods	Free-Run refreshing	
Unit power supply	Power supply voltage	24 VDC (20.4 to 28.8 VDC)
	NX Unit power supply capacity	10 W max.
	NX Unit power supply efficiency	70%
	Isolation method	No isolation between NX Unit power supply and Unit power supply terminals
I/O power supply	Current capacity of power supply terminals	4 A max.
	Power supply voltage	5 to 24 VDC (4.5 to 28.8 VDC) *2
	Maximum I/O power supply current	10 A
	Current capacity of power supply terminals	10 A max.
NX Unit power consumption	1.60 W max.	
Current consumption from I/O power supply	10 mA max. (for 24 VDC)	
Dielectric strength	510 VAC for 1 min, leakage current: 5 mA max. (between isolated circuits)	
Insulation resistance	100 VDC, 20 MΩ min. (between isolated circuits)	
External connection terminals	Communications Connector For EtherNet/IP communications. <ul style="list-style-type: none"> • RJ45 × 2 (shielded) 	
	Screwless Clamping Terminal Block For Unit power supply, I/O power supply, and grounding. Removable.	
	Peripheral USB Port For Sysmac Studio connection. <ul style="list-style-type: none"> • Physical layer: USB 2.0-compliant, B-type connector • Transmission distance: 5 m max. 	
Dimensions	46 × 100 × 71 mm (W×H×D)	
Weight	150 g max.	

*1. Refer to the NX-series Safety Control Unit User's Manual (Cat. No. Z930) for the number of Safety Control Units that can be connected.

*2. Use a voltage that is appropriate for the I/O circuits of the NX Units and the connected external devices.

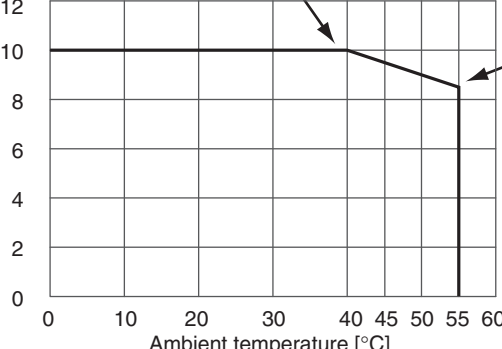
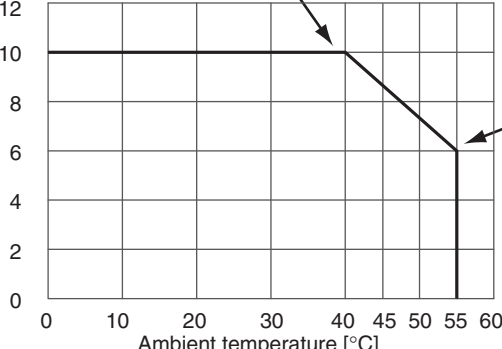
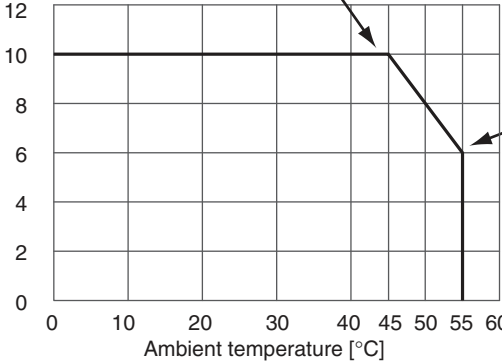
Item	Specification														
<p>Installation orientation and restrictions</p>	<p>Installation orientation: 6 possible orientations</p> <p>Restrictions:</p> <ul style="list-style-type: none"> Used in the upright installation orientation.  <p>Unit power supply [W]</p> <p>10 W output, 40°C</p> <p>8.5 W output, 55°C</p>  <table border="1"> <caption>Unit power supply [W] vs Ambient temperature [°C] (Upright)</caption> <thead> <tr> <th>Ambient temperature [°C]</th> <th>Unit power supply [W]</th> </tr> </thead> <tbody> <tr><td>0</td><td>10</td></tr> <tr><td>10</td><td>10</td></tr> <tr><td>20</td><td>10</td></tr> <tr><td>30</td><td>10</td></tr> <tr><td>40</td><td>10</td></tr> <tr><td>55</td><td>8.5</td></tr> </tbody> </table>	Ambient temperature [°C]	Unit power supply [W]	0	10	10	10	20	10	30	10	40	10	55	8.5
	Ambient temperature [°C]	Unit power supply [W]													
	0	10													
10	10														
20	10														
30	10														
40	10														
55	8.5														
<ul style="list-style-type: none"> Used in any other orientation than the upright installation orientation. <p>Unit power supply [W]</p> <p>10 W output, 40°C</p> <p>6.0 W output, 55°C</p>  <table border="1"> <caption>Unit power supply [W] vs Ambient temperature [°C] (Non-upright)</caption> <thead> <tr> <th>Ambient temperature [°C]</th> <th>Unit power supply [W]</th> </tr> </thead> <tbody> <tr><td>0</td><td>10</td></tr> <tr><td>10</td><td>10</td></tr> <tr><td>20</td><td>10</td></tr> <tr><td>30</td><td>10</td></tr> <tr><td>40</td><td>10</td></tr> <tr><td>55</td><td>6.0</td></tr> </tbody> </table>	Ambient temperature [°C]	Unit power supply [W]	0	10	10	10	20	10	30	10	40	10	55	6.0	
Ambient temperature [°C]	Unit power supply [W]														
0	10														
10	10														
20	10														
30	10														
40	10														
55	6.0														
<p>I/O power supply [A]</p> <p>10 A current, 45°C</p> <p>6 A current, 55°C</p>  <table border="1"> <caption>I/O power supply [A] vs Ambient temperature [°C]</caption> <thead> <tr> <th>Ambient temperature [°C]</th> <th>I/O power supply [A]</th> </tr> </thead> <tbody> <tr><td>0</td><td>10</td></tr> <tr><td>10</td><td>10</td></tr> <tr><td>20</td><td>10</td></tr> <tr><td>30</td><td>10</td></tr> <tr><td>45</td><td>10</td></tr> <tr><td>55</td><td>6</td></tr> </tbody> </table>	Ambient temperature [°C]	I/O power supply [A]	0	10	10	10	20	10	30	10	45	10	55	6	
Ambient temperature [°C]	I/O power supply [A]														
0	10														
10	10														
20	10														
30	10														
45	10														
55	6														

Item	Specification
<p>Circuit layout</p>	
<p>Terminal arrangement</p>	
<p>Accessory</p>	<p>End Cover (NX-END01): 1</p>

Configuration Unit

Refer to the user's manuals for information on the NX Units that can be connected to the NX-series EtherNet/IP Coupler Unit.

EtherNet/IP Coupler Unit

Unit	Model
EtherNet/IP Coupler Unit	NX-EIC202

I/O Units

Unit	Model				
	2-point Units	4-point Units	8-point Units	16-point Units	32-point Units
Digital Input Unit	-	NX-ID3317 NX-ID3343 NX-ID3417 NX-ID3443 NX-IA3117	NX-ID4342 NX-ID4442	NX-ID5142-5 NX-ID5342 NX-ID5442	NX-ID6142-5
Digital Output Unit	NX-OC2633 NX-OC2733	NX-OD3121 NX-OD3153 NX-OD3256 NX-OD3257	NX-OD4121 NX-OD4256	NX-OD5121 NX-OD5121-5 NX-OD5256 NX-OD5256-5	NX-OD6121-5 NX-OD6256-5
Digital Mixed I/O Unit	-	-	-	NX-MD6121-5 NX-MD6256-5	-
Analog Input Unit	NX-AD2603 NX-AD2604 NX-AD2608 NX-AD2203 NX-AD2204 NX-AD2208	NX-AD3603 NX-AD3604 NX-AD3608 NX-AD3203 NX-AD3204 NX-AD3208	NX-AD4603 NX-AD4604 NX-AD4608 NX-AD4203 NX-AD4204 NX-AD4208	-	-
Analog Output Unit	NX-DA2603 NX-DA2605 NX-DA2203 NX-DA2205	NX-DA3603 NX-DA3605 NX-DA3203 NX-DA3205	-	-	-
Temperature Input Unit	NX-TS2101 NX-TS2102 NX-TS2104 NX-TS2201 NX-TS2202 NX-TS2204	NX-TS3101 NX-TS3102 NX-TS3104 NX-TS3201 NX-TS3202 NX-TS3204	-	-	-

Position Interface Unit

Unit	Model	
	1CH	2CH
Incremental Encoder Input Unit	NX-EC0112 NX-EC0122 NX-EC0132 NX-EC0142	NX-EC0212 NX-EC0222
SSI Input Unit	NX-ECS112	NX-ECS212
Pulse Output Unit	NX-PG0122	-

System Units

Unit	Model
Additional NX Unit Power Supply Unit	NX-PD1000
Additional I/O Power Supply Unit	NX-PF0630 NX-PF0730
I/O Power Supply Connection Unit	NX-PC0010 NX-PC0020 NX-PC0030
Shield Connection Unit	NX-TBX01

Safety Control Units

Unit	Model
Safety CPU Unit	NX-SL3300 *1
Safety Input Unit	NX-SIH400 *2 NX-SID800
Safety Output Unit	NX-SOH200 NX-SOD400

*1 Safety CPU Unit Ver.1.1 or higher.

*2 Safety Input Unit Ver.1.1 or higher.

Version Information

NX-series EtherNet/IP Coupler Unit and Sysmac Studio

NX Units		version
Model	Unit Version	Sysmac Studio
NX-EIC202	Ver.1.0	Version 1.10 or later

NX-EIC

External Interface

EtherNet/IP Coupler Unit NX-EIC202

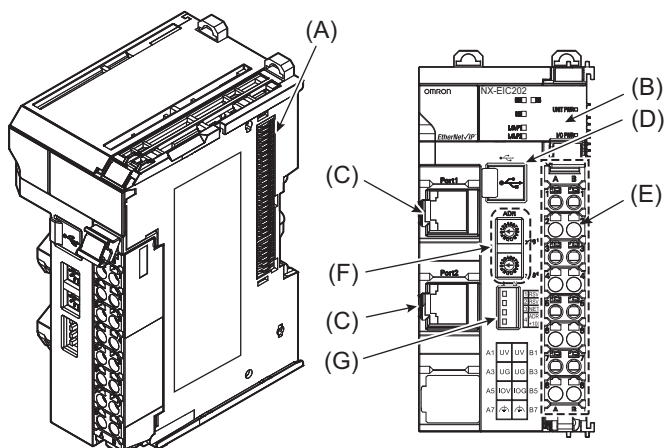

Letter	Name	Function
(A)	NX bus connector	This connector is used to connect the EtherNet/IP Coupler Unit to the NX Unit on the right of the Coupler Unit.
(B)	Indicators	The indicators show the current operating status of the Unit and the status of the power supply.
(C)	Communications connectors	These connectors are connected to the communications cables of the EtherNet/IP network.
(D)	Peripheral USB port	This port is used to connect to the Sysmac Studio.
(E)	Terminal block	The terminal block is used to connect to the power supply cables and ground wire.
(F)	Rotary switches	The rotary switches are used to set the last octet of the IP address of the EtherNet/IP Coupler Unit as an EtherNet/IP Slave. The address is set in hexadecimal.
(G)	DIP switch	The DIP switch is used to set the default node address of the EtherNet/IP Coupler Unit as an EtherNet/IP slave.

Terminal Block

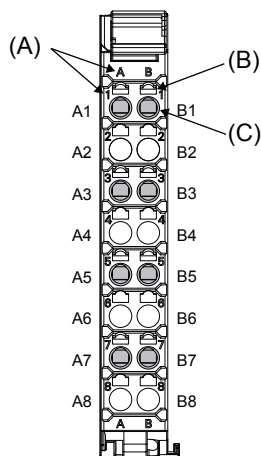

Eight-terminal Block

Symbol	Name	Function
(A)	Terminal number indications	The terminal numbers (A1 to A8 and B1 to B8) are displayed. The terminal number indicators are the same regardless of the number of terminals on the terminal block, as shown above.
(B)	Release holes	Insert a flat-blade screwdriver into these holes to connect and remove the wires.
(C)	Terminal holes	The wires are inserted into these holes.

Applicable Wires

Using Ferrules

If you use ferrules, attach the twisted wires to them.

Observe the application instructions for your ferrules for the wire stripping length when attaching ferrules.

Always use plated one-pin ferrules. Do not use unplated ferrules or two-pin ferrules.

The applicable ferrules, wires, and crimping tool are given in the following table.

Terminal types	Manufacturer	Ferrule model	Applicable wire (mm ² (AWG))	Crimping tool	
Terminals other than ground terminals	Phoenix Contact	AI0,34-8	0.34 (#22)	Phoenix Contact (The figure in parentheses is the applicable wire size.) CRIMPFOX 6 (0.25 to 6 mm ² , AWG 24 to 10)	
		AI0,5-8	0.5 (#20)		
		AI0,5-10			
		AI0,75-8	0.75 (#18)		
		AI0,75-10			
		AI1,0-8	1.0 (#18)		
		AI1,0-10			
		AI1,5-8	1.5 (#16)		
AI1,5-10					
Ground terminals		AI2,5-10	2.0 *1		
Terminals other than ground terminals	Weidmuller	H0.14/12	0.14 (#26)		Weidmuller (The figure in parentheses is the applicable wire size.) PZ6 Roto (0.14 to 6 mm ² , AWG 26 to 10)
		H0.25/12	0.25 (#24)		
		H0.34/12	0.34 (#22)		
		H0.5/14	0.5 (#20)		
		H0.5/16			
		H0.75/14	0.75 (#18)		
		H0.75/16			
		H1.0/14	1.0 (#18)		
		H1.0/16			
		H1.5/14	1.5 (#16)		
H1.5/16					

*1. Some AWG 14 wires exceed 2.0 mm² and cannot be used in the screwless clamping terminal block.

When you use any ferrules other than those in the above table, crimp them to the twisted wires so that the following processed dimensions are achieved.

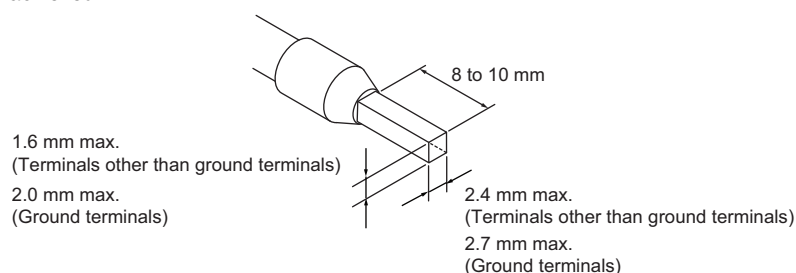

Using Twisted Wires/Solid Wires

If you use the twisted wires or the solid wires, use the following table to determine the correct wire specifications.

Terminals		Wire type				Wire size	Conductor length (stripping length)
		Twisted wires		Solid wire			
Classification	Current capacity	Plated	Unplated	Plated	Unplated		
All terminals except ground terminals	2 A max.	Possible	Possible	Possible	Possible	0.08 to 1.5 mm ² AWG28 to 16	8 to 10 mm
	Greater than 2 A and 4 A or less		Not Possible	Possible *1	Not Possible		
	Greater than 4 A		Possible *1	Not Possible	Not Possible		
Ground terminals	---	Possible	Possible	Possible *2	Possible *2	2.0 mm ²	9 to 10 mm

*1 Secure wires to the screwless clamping terminal block. Refer to the Securing Wires in the USER'S MANUAL for how to secure wires.

*2 With the NX-TB□□□1 Terminal Block, use twisted wires to connect the ground terminal. Do not use a solid wire.

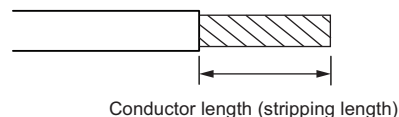

<Additional Information> If more than 2 A will flow on the wires, use plated wires or use ferrules.

● EtherCAT Coupler Unit Only

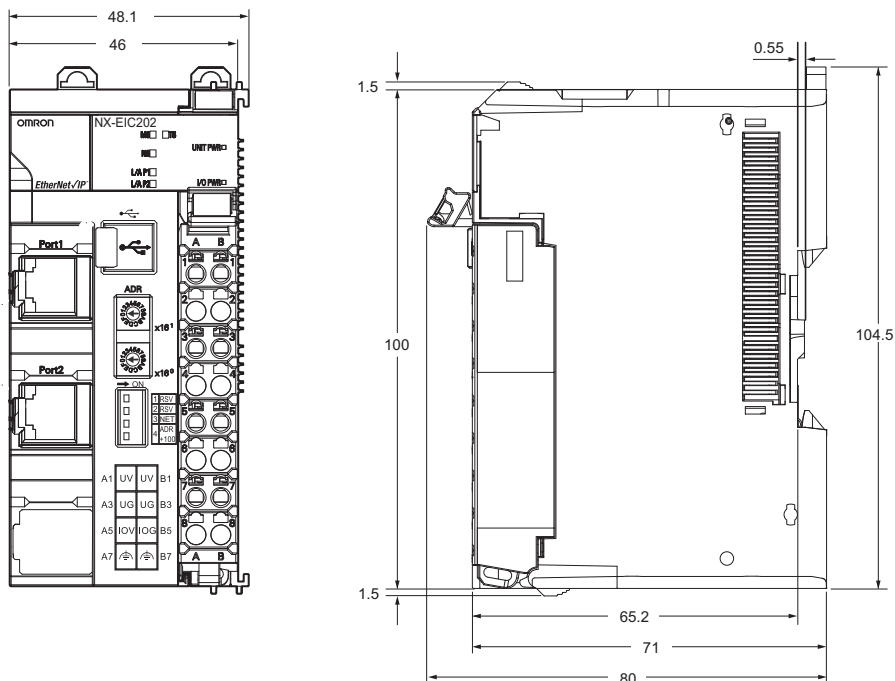

● With Cables Connected

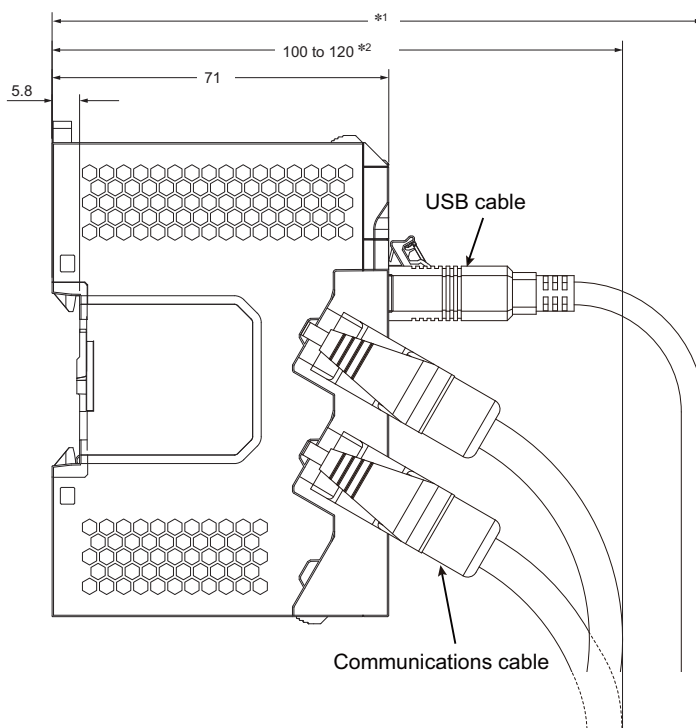

*1. This dimension depends on the specifications of the commercially available USB cable. Check the specifications of the USB cable that is used.

*2. This is the dimension from the back of the Unit to the communications cables.

- 100 mm: When an MPS588-C Connector is used.
- 120 mm: When an XS6G-T421-1 Connector is used.

● End Cover

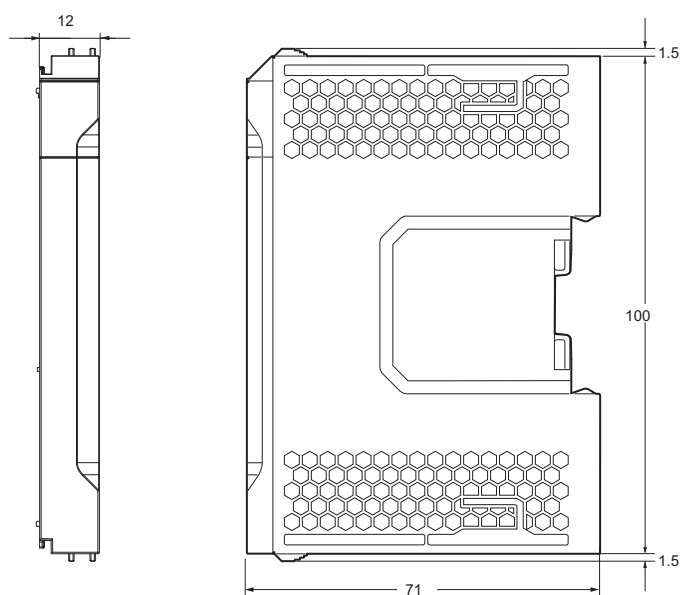

Related Manuals

Man. No	Model	Manual	Application	Description
W536	NX-EIC□□□□	NX-series EtherNet/IP Coupler Unit User's Manual	Learning how to use an NX-series Ether-Net/IP Coupler Unit and EtherNet/IP Slave Terminals	Introduces the system, configuration methods, Unit hardware, setting methods, and functions of EtherNet/IP Slave Terminals that consist of an EtherNet/IP Coupler Unit and NX Units.
W525	NX-□□□□□□	NX-series Data Reference Manual	Referencing lists of the data that is required to configure systems with NX-series Units	Lists of the power consumptions, weights, and other NX Unit data that is required to configure systems with NX-series Units are provided.
W521	NX-ID□□□□ NX-IA□□□□ NX-OC□□□□ NX-OD□□□□ NX-MD□□□□	NX-series Digital I/O Units User's Manual	Learning how to use NX-series Digital I/O Units	The hardware, setup methods, and functions of the NX-series Digital I/O Units are described.
W522	NX-AD□□□□ NX-DA□□□□ NX-TS□□□□	NX-series Analog I/O Units User's Manual	Learning how to use NX-series Analog I/O Units and Temperature Input Units	The hardware, setup methods, and functions of the NX-series Analog I/O Units and Temperature Input Units are described.
W523	NX-PD1□□□ NX-PF0□□□ NX-PC0□□□ NX-TBX01	NX-series System Units User's Manual	Learning how to use NX-series System Units	The hardware and functions of the NX-series System Units are described.
W524	NX-EC0□□□ NX-ECS□□□ NX-PG0□□□	NX-series Position Interface Units User's Manual	Learning how to use NX-series Position Interface Units	The hardware, setup methods, and functions of the NX-series Incremental Encoder Input Units, SSI Input Units, and Pulse Output Unit are described.
Z930	NX-SL□□□□ NX-SI□□□□ NX-SO□□□□	NX-series Safety Control Unit User's Manual	Learning how to use NX-series Safety Control Units	The hardware, setup methods, and functions of the NX-series Safety Control Units are described.
Z931	NX-SL□□□□	NX-series Safety Control Unit Instructions Reference Manual	Learning about the specifications of instructions for the Safety CPU Unit.	The instructions for the Safety CPU Unit are described. When programming, use this manual together with the <i>NX-series Safety Control Unit User's Manual</i> (Cat. No. Z930).

MEMO

Terms and Conditions Agreement

Read and understand this catalog.

Please read and understand this catalog before purchasing the products. Please consult your OMRON representative if you have any questions or comments.

Warranties.

(a) Exclusive Warranty. Omron's exclusive warranty is that the Products will be free from defects in materials and workmanship for a period of twelve months from the date of sale by Omron (or such other period expressed in writing by Omron). Omron disclaims all other warranties, express or implied.

(b) Limitations. OMRON MAKES NO WARRANTY OR REPRESENTATION, EXPRESS OR IMPLIED, ABOUT NON-INFRINGEMENT, MERCHANTABILITY OR FITNESS FOR A PARTICULAR PURPOSE OF THE PRODUCTS. BUYER ACKNOWLEDGES THAT IT ALONE HAS DETERMINED THAT THE PRODUCTS WILL SUITABLY MEET THE REQUIREMENTS OF THEIR INTENDED USE.

Omron further disclaims all warranties and responsibility of any type for claims or expenses based on infringement by the Products or otherwise of any intellectual property right. (c) Buyer Remedy. Omron's sole obligation hereunder shall be, at Omron's election, to (i) replace (in the form originally shipped with Buyer responsible for labor charges for removal or replacement thereof) the non-complying Product, (ii) repair the non-complying Product, or (iii) repay or credit Buyer an amount equal to the purchase price of the non-complying Product; provided that in no event shall Omron be responsible for warranty, repair, indemnity or any other claims or expenses regarding the Products unless Omron's analysis confirms that the Products were properly handled, stored, installed and maintained and not subject to contamination, abuse, misuse or inappropriate modification. Return of any Products by Buyer must be approved in writing by Omron before shipment. Omron Companies shall not be liable for the suitability or unsuitability or the results from the use of Products in combination with any electrical or electronic components, circuits, system assemblies or any other materials or substances or environments. Any advice, recommendations or information given orally or in writing, are not to be construed as an amendment or addition to the above warranty.

See <http://www.omron.com/global/> or contact your Omron representative for published information.

Limitation on Liability; Etc.

OMRON COMPANIES SHALL NOT BE LIABLE FOR SPECIAL, INDIRECT, INCIDENTAL, OR CONSEQUENTIAL DAMAGES, LOSS OF PROFITS OR PRODUCTION OR COMMERCIAL LOSS IN ANY WAY CONNECTED WITH THE PRODUCTS, WHETHER SUCH CLAIM IS BASED IN CONTRACT, WARRANTY, NEGLIGENCE OR STRICT LIABILITY.

Further, in no event shall liability of Omron Companies exceed the individual price of the Product on which liability is asserted.

Suitability of Use.

Omron Companies shall not be responsible for conformity with any standards, codes or regulations which apply to the combination of the Product in the Buyer's application or use of the Product. At Buyer's request, Omron will provide applicable third party certification documents identifying ratings and limitations of use which apply to the Product. This information by itself is not sufficient for a complete determination of the suitability of the Product in combination with the end product, machine, system, or other application or use. Buyer shall be solely responsible for determining appropriateness of the particular Product with respect to Buyer's application, product or system. Buyer shall take application responsibility in all cases.

NEVER USE THE PRODUCT FOR AN APPLICATION INVOLVING SERIOUS RISK TO LIFE OR PROPERTY OR IN LARGE QUANTITIES WITHOUT ENSURING THAT THE SYSTEM AS A WHOLE HAS BEEN DESIGNED TO ADDRESS THE RISKS, AND THAT THE OMRON PRODUCT(S) IS PROPERLY RATED AND INSTALLED FOR THE INTENDED USE WITHIN THE OVERALL EQUIPMENT OR SYSTEM.

Programmable Products.

Omron Companies shall not be responsible for the user's programming of a programmable Product, or any consequence thereof.

Performance Data.

Data presented in Omron Company websites, catalogs and other materials is provided as a guide for the user in determining suitability and does not constitute a warranty. It may represent the result of Omron's test conditions, and the user must correlate it to actual application requirements. Actual performance is subject to the Omron's Warranty and Limitations of Liability.

Change in Specifications.

Product specifications and accessories may be changed at any time based on improvements and other reasons. It is our practice to change part numbers when published ratings or features are changed, or when significant construction changes are made. However, some specifications of the Product may be changed without any notice. When in doubt, special part numbers may be assigned to fix or establish key specifications for your application. Please consult with your Omron's representative at any time to confirm actual specifications of purchased Product.

Errors and Omissions.

Information presented by Omron Companies has been checked and is believed to be accurate; however, no responsibility is assumed for clerical, typographical or proofreading errors or omissions.

Note: Do not use this document to operate the Unit.

OMRON Corporation Industrial Automation Company
Kyoto, JAPAN

Contact: www.ia.omron.com

Regional Headquarters

OMRON EUROPE B.V.

Wegalaan 67-69, 2132 JD Hoofddorp
The Netherlands
Tel: (31)2356-81-300/Fax: (31)2356-81-388

OMRON ELECTRONICS LLC

2895 Greenspoint Parkway, Suite 200
Hoffman Estates, IL 60169 U.S.A.
Tel: (1) 847-843-7900/Fax: (1) 847-843-7787

OMRON ASIA PACIFIC PTE. LTD.

No. 438A Alexandra Road # 05-05/08 (Lobby 2),
Alexandra Technopark,
Singapore 119967
Tel: (65) 6835-3011/Fax: (65) 6835-2711

OMRON (CHINA) CO., LTD.

Room 2211, Bank of China Tower,
200 Yin Cheng Zhong Road,
PuDong New Area, Shanghai, 200120, China
Tel: (86) 21-5037-2222/Fax: (86) 21-5037-2200

Authorized Distributor:

© OMRON Corporation 2014 All Rights Reserved.
In the interest of product improvement,
specifications are subject to change without notice.

CSM_4_4_0416

Cat. No. R183-E1-02

1015 (1214)

X-ON Electronics

Largest Supplier of Electrical and Electronic Components

Click to view similar products for [omron](#) manufacturer:

Other Similar products are found below :

[G9ED-1-B-AQ-DC24](#) [E3X-SD11 2M](#) [S8VM-10024C](#) [R88A-CCW002P2](#) [S82Y-VM30D](#) [H3AM-NS-A AC100-240](#) [G3NA-440B-2 DC5-24](#)
[XF2J-0824-11A-R100](#) [G3NA-425B-2 DC5-24](#) [XF2J-0824-12A](#) [G8JN-1C7T-R-DC12](#) [G8VA-1A4T-R01-DC12](#) [G8HE-1A7T-R-DC12](#)
[XF2W-2415-1A](#) [XF2U-3015-3A](#) [G8V-RH-1A7T-R-DC12](#) [LY1D-2-5S-AC120](#) [M165-JR-24D](#) [M16-TG-24D](#) [CS1G-CPU43-E](#) [M22CAT1](#)
[61F-GP-NT AC110](#) [M7E-01DGN2-B](#) [M7E-02DGN2](#) [M7E-08DRN2](#) [M7E-20DRN1](#) [M7E-HRN2](#) [M8PHWS](#) [D2HW-C233MR](#) [F03-02](#)
[SUS316](#) [F150LTC20](#) [F3SJ-A0245P30](#) [F3STGRNSMC21M1J8](#) [F3UVHM](#) [MG2-US-AC24](#) [MK2EP-UA-AC6V](#) [MK2PNIAC240](#) [MK310E-](#)
[DC24](#) [MKS2XTIN-11 DC110](#) [MM4KPAC120NC](#) [MM4XPAC120](#) [G2Q-184P-V-DC5](#) [G2R-1114P-V-US-DC5](#) [G2R13SNDDC24](#) [G2RL-](#)
[2A4-CF-DC48](#) [G2U-114P-US-DC12](#) [G2V-234P-US-DC48](#) [G3CA-8H-AC100/110/120](#) [G3PA-210B-US-DC24](#) [G3PE525B3NDC1224](#)