

# 2J0102-C366N

## 2.4/5.0 GHz ISM Connector Mount

### Key Features

#### 2.4/5.0 GHz ISM

- 2410-2490 MHz
- 4920-5925 MHz

Connector Mount

Ground Plane Dependent

High Gain

Dimensions 53 x 10 x 18 mm



## 1. Antenna and electrical specifications

Parameters	2.4/5.0 GHz ISM Antenna	
<b>Standards</b>	WiFi, BT, ZigBee, ISM	
<b>Band (MHz)</b>	2.4 Ghz	5.0 Ghz
<b>Frequency (MHz)</b>	2410-2490	4920-5925
<b>Return Loss (dB)</b>	~-14.7	~-12.8
<b>VSWR</b>	~1.4:1	~1.7:1
<b>Efficiency (%)</b>	~60	~83
<b>Peak Gain (dBi)</b>	~-4.0	~-5.2
<b>Average Gain (dB)</b>	~-2.2	~-0.9
<b>Impedance (Ohm)</b>	50	
<b>Polarisation</b>	Linear	
<b>Radiation Pattern</b>	Omni-Directional	
<b>Max. Input Power (W)</b>	25	
<b>Connector Type</b>	Most RF Connectors (RP-SMA-Male-RA Standard)	

### Antenna Measurement Conditions:

Mounted on Ground Plane of 70x35 mm

Measured in Certified CTIA 3D Anechoic Chamber

## 2. Mechanical and environmental specifications

Specifications	2J0102-C366N
<b>Mounting Type</b>	Connector Mount
<b>Dimensions (mm)</b>	53 × 10 × 18
<b>Radome</b>	ABS UV Stable
<b>Radome color</b>	Black
<b>Operating Temperature (C)</b>	-40 to +85
<b>Storage Temperature (C)</b>	-40 to +85
<b>Substance Compliance</b>	RoHS

### 3. Antenna parameters

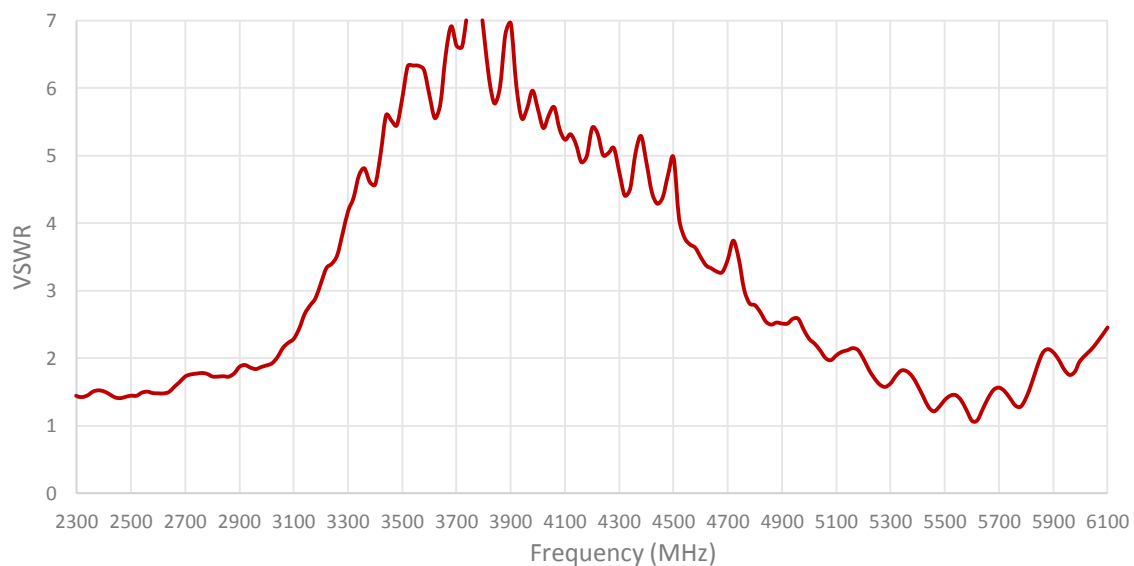
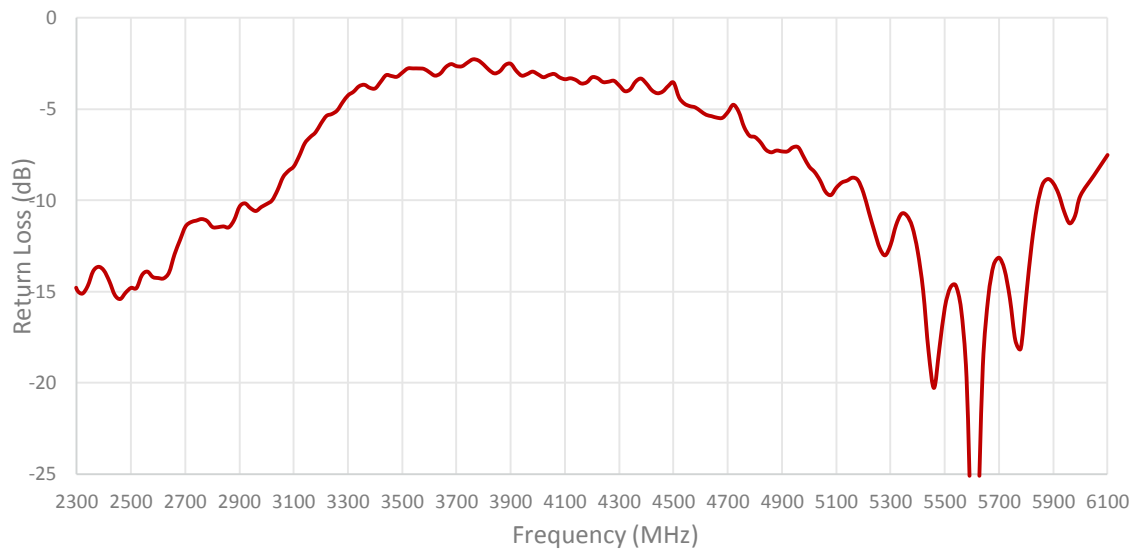

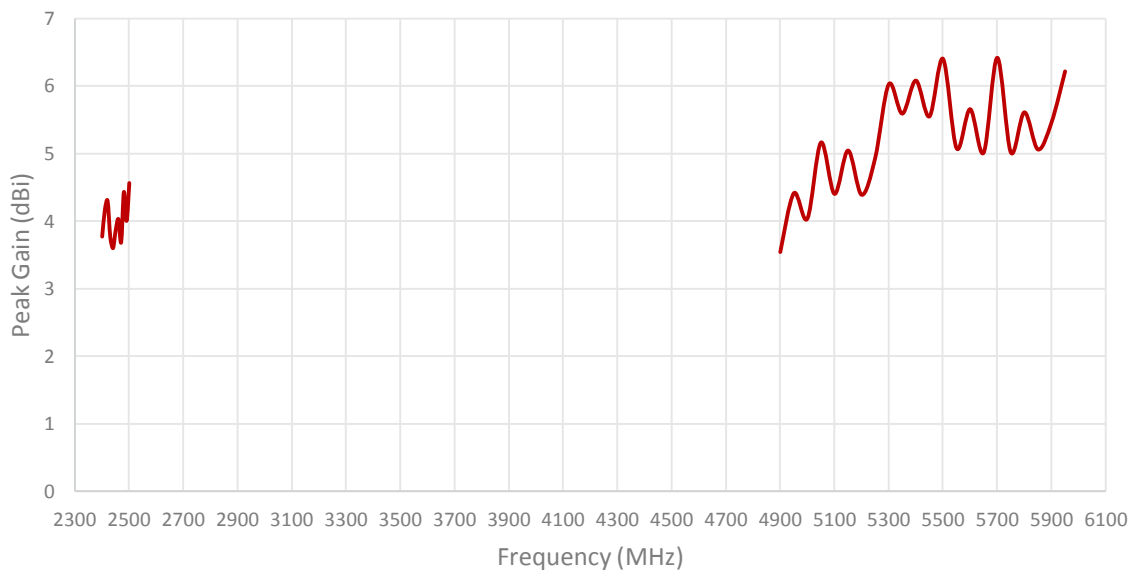
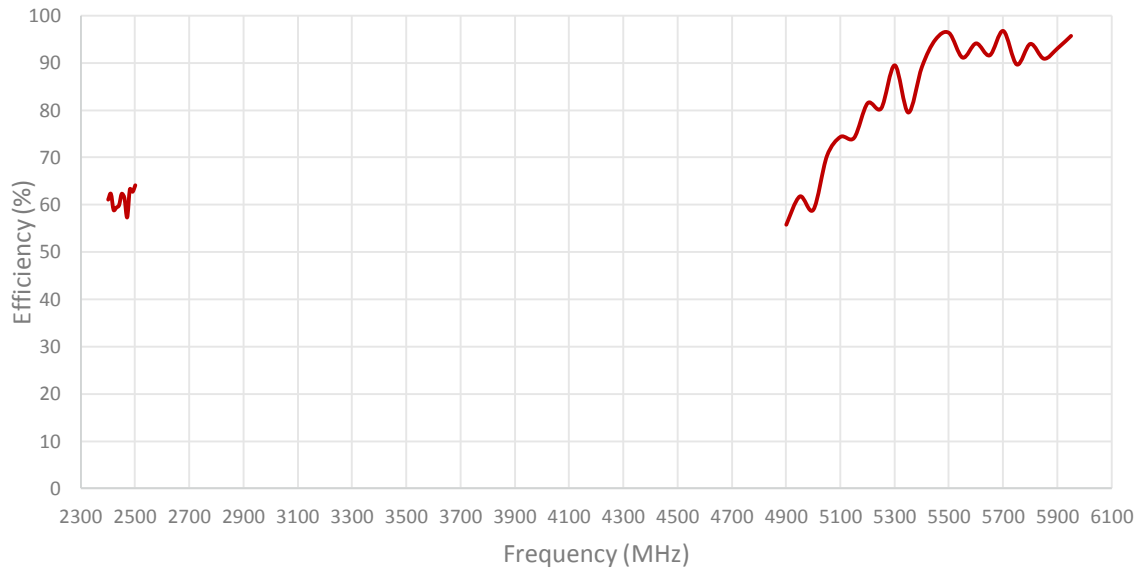

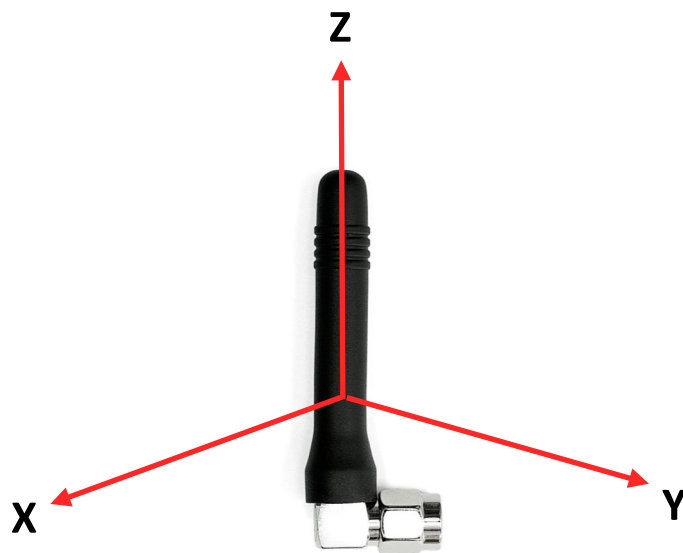
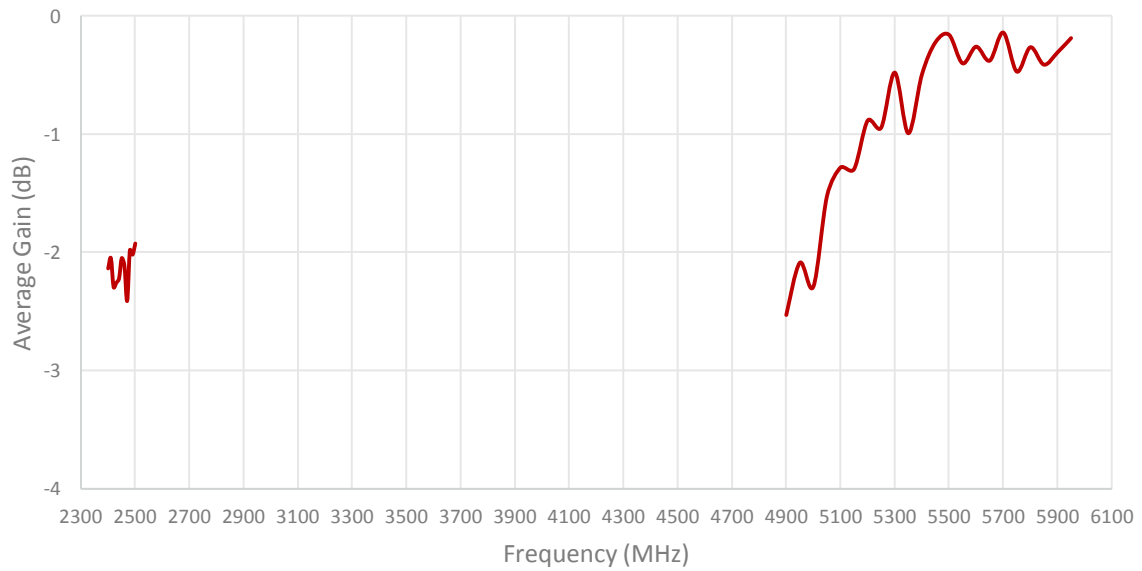

Radiation pattern reference

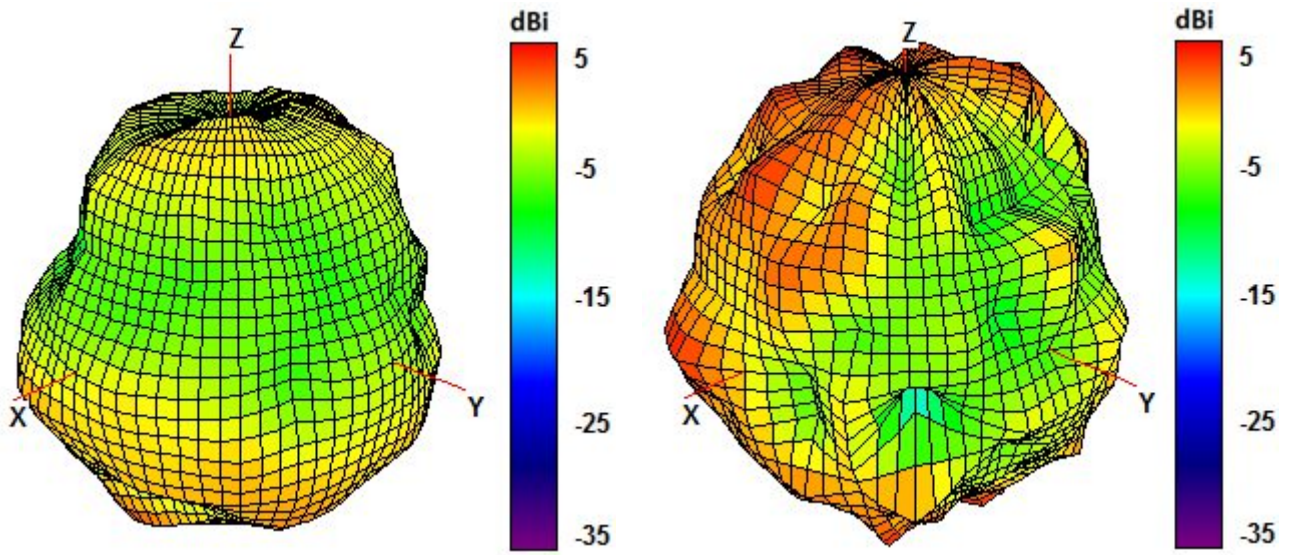

2450 and 5500 MHz Radiation pattern

## 4. Antenna drawings

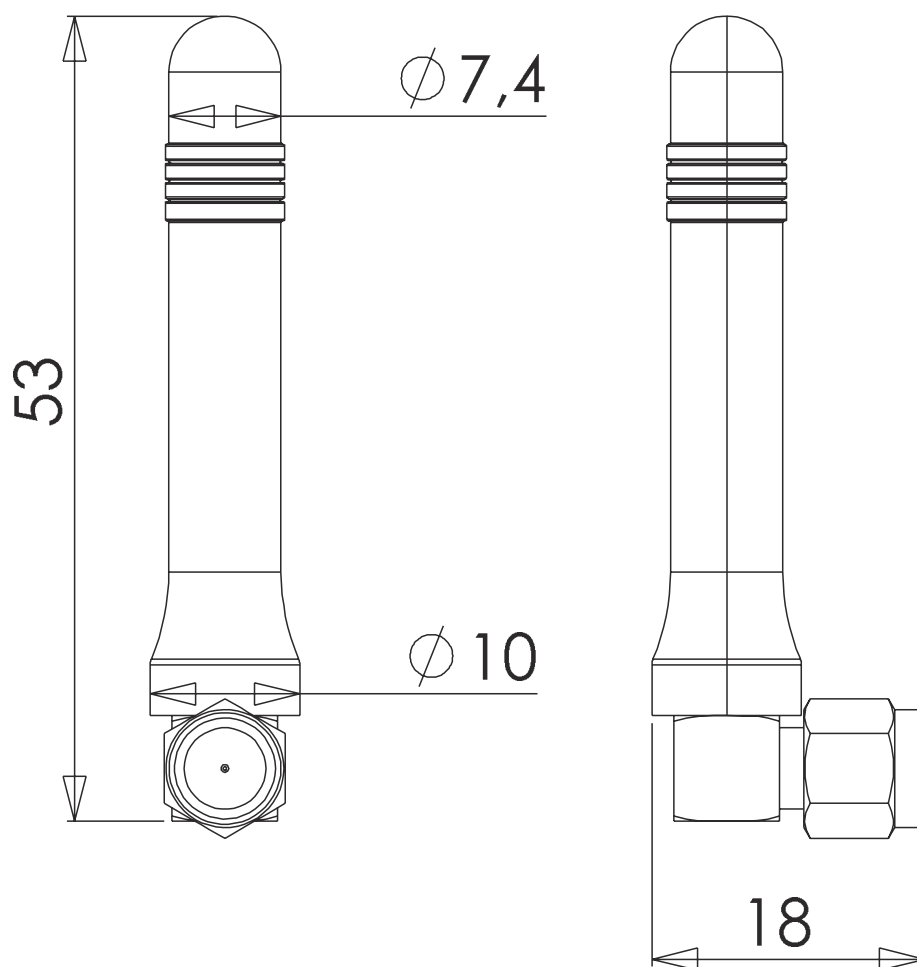

5. Antenna Images





## X-ON Electronics

Largest Supplier of Electrical and Electronic Components

*Click to view similar products for [Antennas](#) category:*

*Click to view products by [2J](#) manufacturer:*

Other Similar products are found below :

[930-033-R](#) [EXE902SM](#) [APAMPG-117](#) [66089-2406](#) [A09-F8NF-M](#) [A09-F5NF-M](#) [RGFRA1903041A1T](#) [108-00016-050](#) [W3525BW100](#)  
[SIMNA-868](#) [SIMNA-915](#) [SIMNA-433](#) [W1049B090](#) [TRABT1560](#) [WTL2449CQ1-FRSMM](#) [CPL9C](#) [0600-00060](#) [Y4503](#) [PAL90209H-FNF](#)  
[GD53-25](#) [C37](#) [MAF94051](#) [S9025PLSMF](#) [EXD420PL](#) [QWFTB120](#) [MAF94300](#) [FG4403](#) [MIKROE-2393](#) [GPSCPMM00](#) [ANTDOM-05-01-](#)  
[WPM](#) [ANT-WP868SMA-Y](#) [EXW30BNX](#) [RAD-ISM-2459-ANT-FOOD-6-0-](#) [S4908WBFNM](#) [GD57-21](#) [108-20131-010](#) [108-00032-010](#)  
[C27S](#) [CBNC58](#) [EXH160MXI](#) [EXH160SFK](#) [MD10-004](#) [EXC902SM](#) [CB27](#) [ABFT](#) [BB4502NR](#) [B4502N](#) [S4908WBFNF](#) [ANT-](#)  
[GSMGPSPUKS](#) [60210](#)