

2J0B04-C884G

CELLULAR Connector Mount

Key Features

CELLULAR

- 824-960 MHz

- 1710-2170 MHz

Connector Mount

Low Profile

Ground Plane Dependent

Dimensions 44 x 19.1 x 9 mm



1. Antenna and electrical specifications

Parameters	CELLULAR Antenna	
Standards	2G and 3G	
Band (MHz)	850/900	1700/1800/1900/2100
Frequency (MHz)	824-960	1710-2170
Return Loss (dB)	~-8.6	~-9.4
VSWR	~2.2:1	~2.4:1
Efficiency (%)	~70.6	~56.4
Peak Gain (dBi)	~-2.9	~-1.8
Average Gain (dB)	~-1.5	~-2.5
Impedance (Ohm)	50	
Polarisation	Linear	
Radiation Pattern	Omni-Directional	
Max. Input Power (W)	25	
Connector Type	SMA-Male Standard (Right-Angle)	

Antenna Measurement Conditions:

Mounted on Ground Plane of 95 x 40 mm

Measured in Certified CTIA 3D Anechoic Chamber

2. Mechanical and environmental specifications

Specifications	2J0B04-C884G
Mounting Type	Connector Mount
Dimensions (mm)	44 x 19.1 x 9
Radome	TPC-ET
Radome color	Black
Operating Temperature (C)	-40 to +85
Storage Temperature (C)	-40 to +85
Substance Compliance	RoHS

3. Antenna parameters

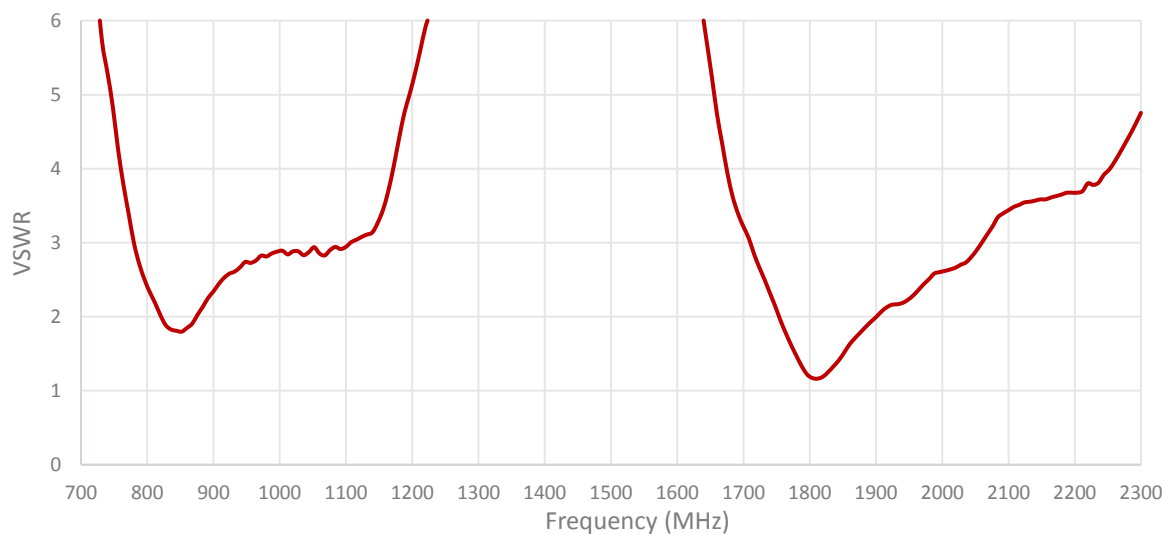
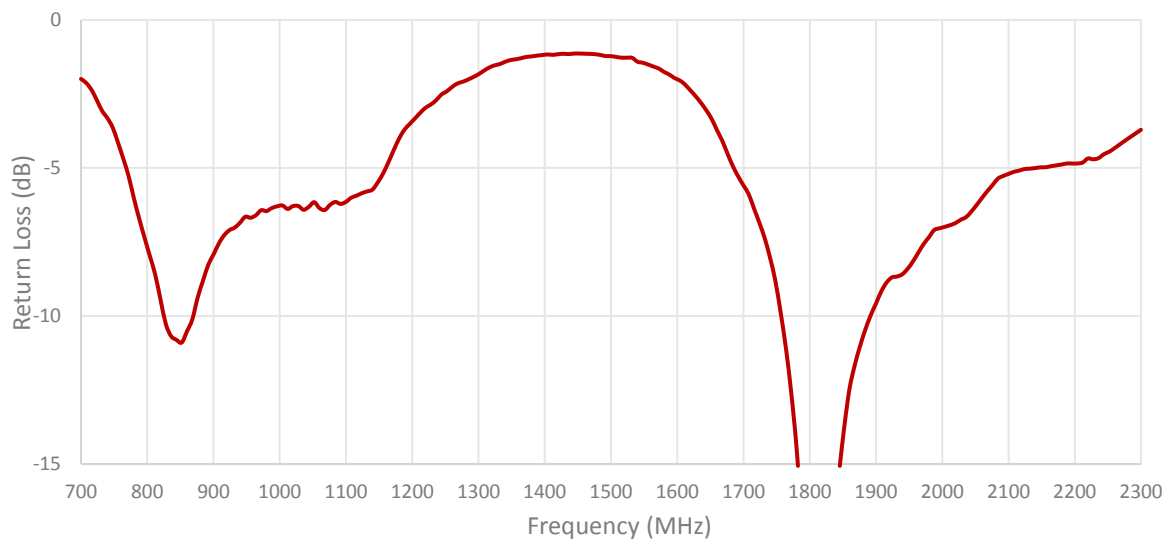

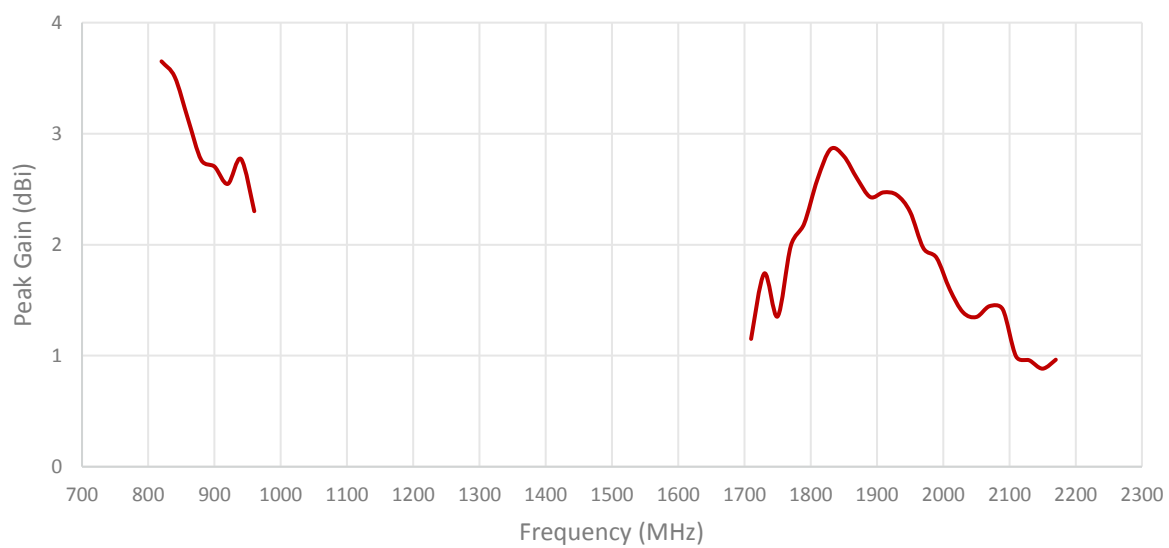
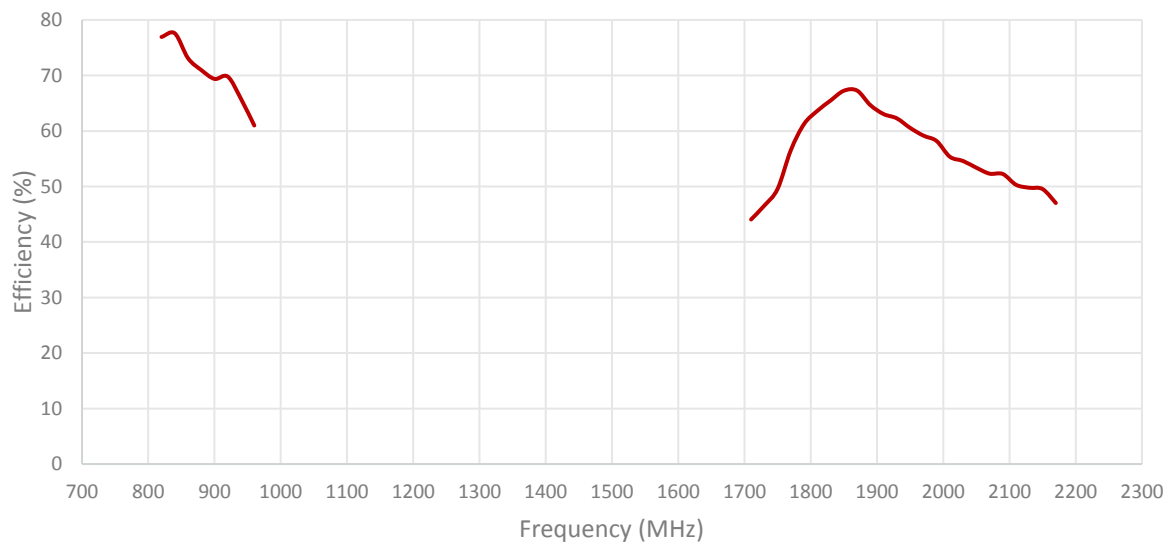

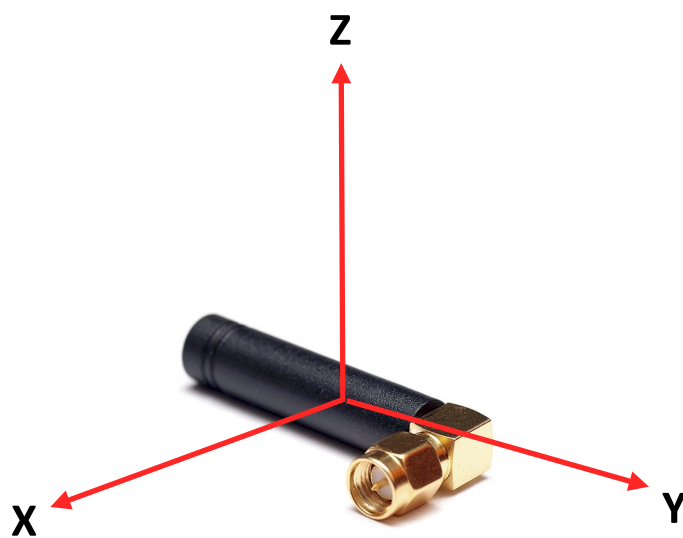
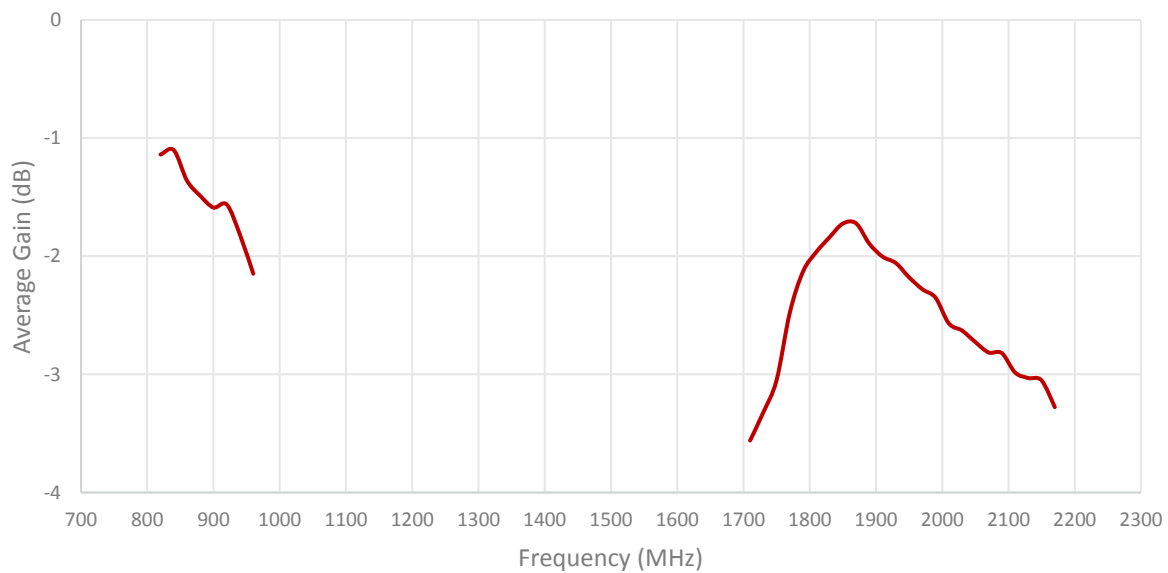

Radiation pattern reference

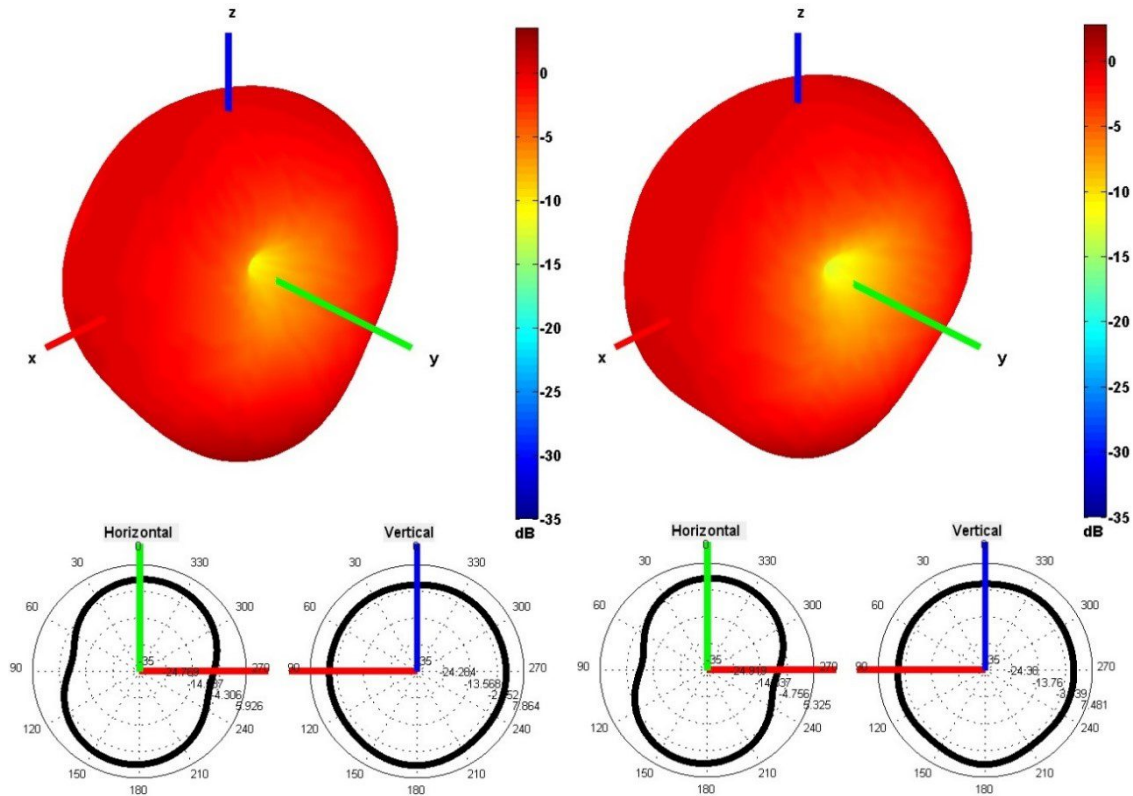

850 and 940 MHz Radiation pattern

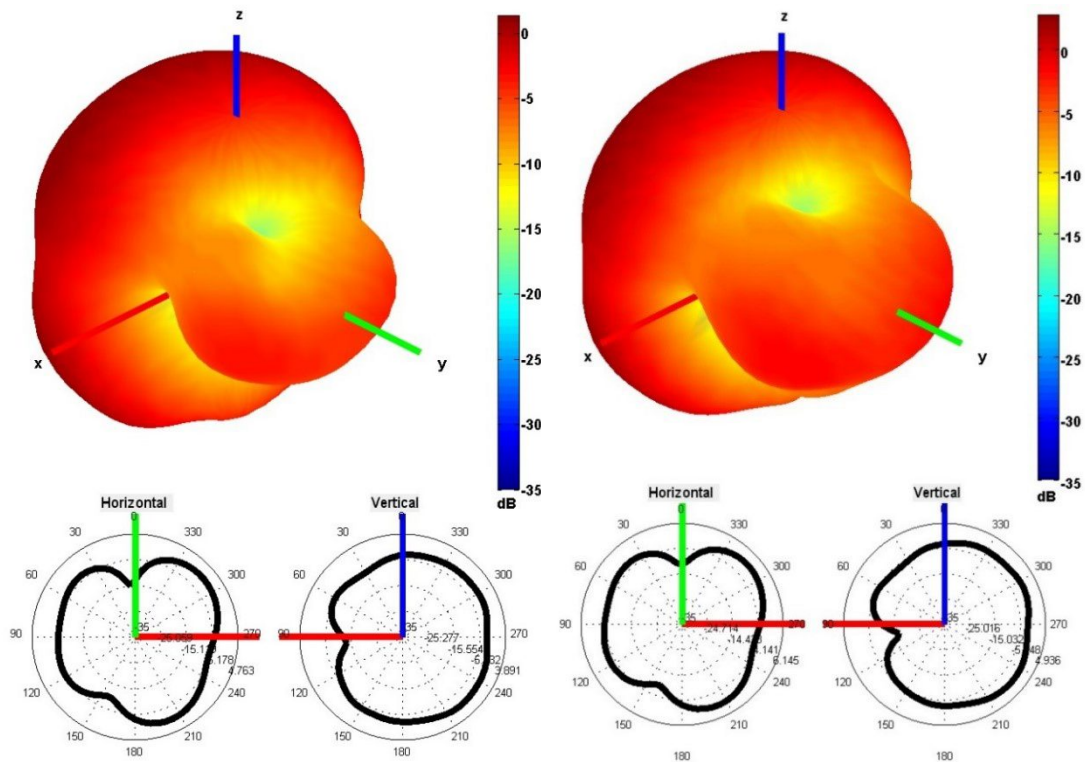

1750 and 1850 MHz Radiation pattern

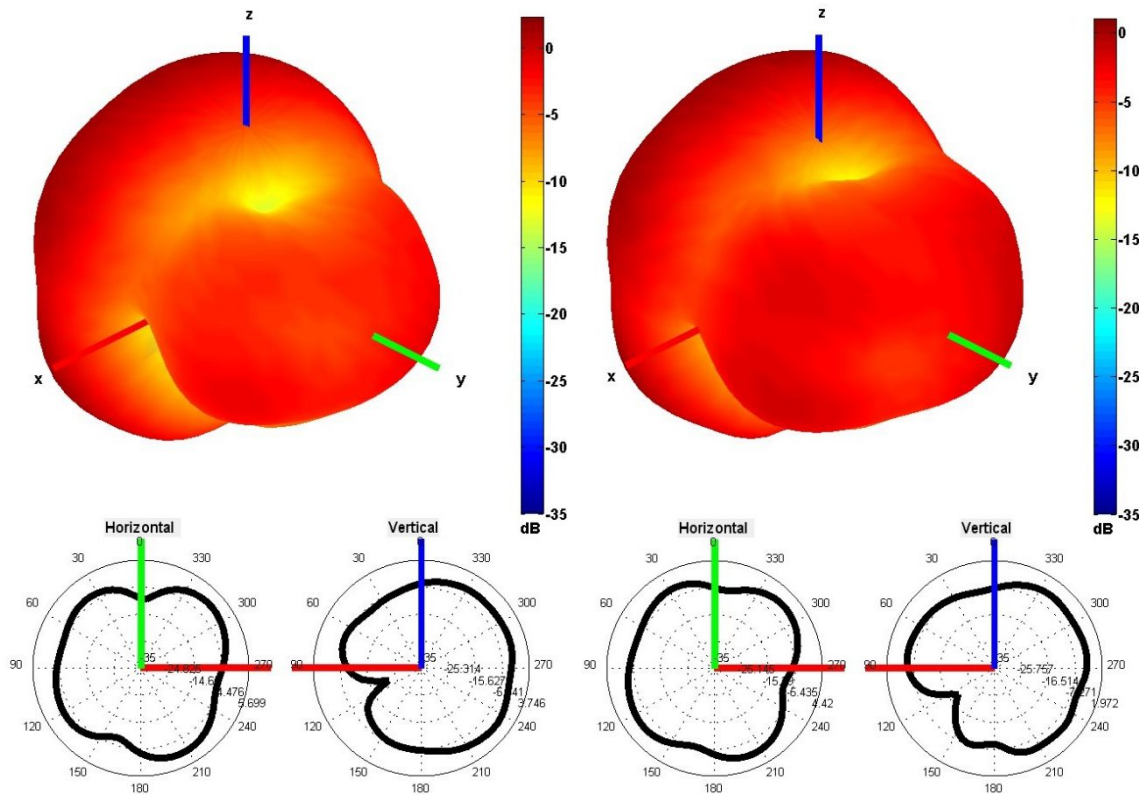

1950 and 2100 MHz Radiation pattern

4. Antenna drawings

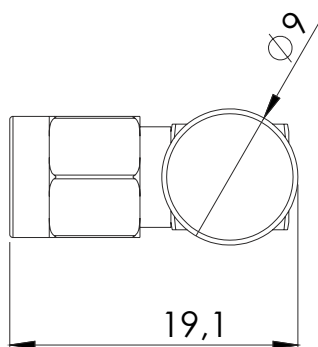
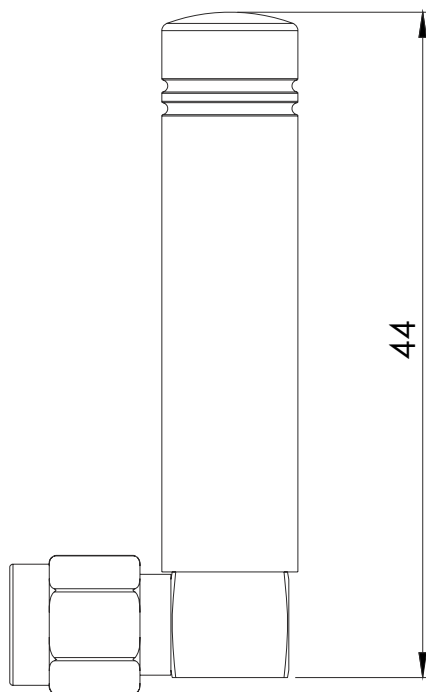

5. Antenna Images



X-ON Electronics

Largest Supplier of Electrical and Electronic Components

Click to view similar products for [Antennas](#) category:

Click to view products by [2J](#) manufacturer:

Other Similar products are found below :

[GAN30084EU](#) [930-033-R](#) [GW17.07.0250E](#) [1513563-1](#) [EXE902SM](#) [APAMPG-117](#) [MAF94383](#) [W3908B0100](#) [W6102B0100](#) [YE572113-30RSMM](#) [108-00014-50](#) [66089-2406](#) [SPDA17RP918](#) [A09-F8NF-M](#) [A09-F5NF-M](#) [RGFRA1903041A1T](#) [W3593B0100](#) [W3921B0100](#) [SIMNA-868](#) [SIMNA-915](#) [SIMNA-433](#) [W1044](#) [W1049B090](#) [A75-001](#) [WTL2449CQ1-FRSMM](#) [CPL9C](#) [EXB148BN](#) [0600-00060](#) [TRA9020S3PBN-001](#) [GD5W-28P-NF](#) [MA9-7N](#) [GD53-25](#) [GD5W-21P-NF](#) [C37](#) [MAF94051](#) [MA9-5N](#) [EXD420PL](#) [B1322NR](#) [QWFTB120](#) [MAF94300](#) [GPSMB301](#) [FG4403](#) [AO-AGSM-OM54](#) [5200232](#) [MIKROE-2349](#) [WCM.01.0111](#) [MIKROE-2393](#) [MIKROE-2352](#) [MIKROE-2350](#) [5200227](#)