

## 2J0B24-C884G

### CELLULAR / LTE Connector Mount

#### Key Features

##### CELLULAR / LTE

- 698-960 MHz
- 1710-2170 MHz
- 2500-2700 MHz

Connector Mount

Low Profile

Wide band Antenna

Ground Plane Dependent

Dimensions 44 × 19.1 × 9 mm



## 1. Antenna Description

### 2J0B24-C884G

#### The elegant size smart antenna with no compromise on efficiency

This Narrowband IoT LTE connector mount antenna 2J0B24 was designed for compact installations with no compromise on efficiency and performance. Suitable for Low Power Wide Area Network NB-IoT applications where devices require constant connectivity within frequencies operating between 698MHz-960MHz, 1710MHz-2170Mhz and 2500MHz-2700Mhz. The 2J0B24 series is ideal for HD video transmission, dash cameras, fleet management, logistics, LTE routers and all other applications that require a cellular connection.

#### Application Parameters

This antenna was designed to improve signal strength allowing uninterrupted connectivity, better signal quality, and reliability while providing increased data throughput. This series is suitable for GSM, CDMA, DCS, PCS, GPRS, WCDMA, UMTS, HSPA, EVDO and LTE (NB-IoT) technologies operating within 4G LTE, 3G, and 2G standards.

#### Typical applications

- Infotainment systems
- HD video transmission
- Dash cameras
- Connected cars
- Self-driving cars
- Fleet management
- Gateways
- Routers
- Public transportation
- Logistics
- And others

#### Key Features

- 12 variations with straight, right-angle and reversed polarity connectors
- Sustained High Efficiency and Performance
- NB-IoT and Portable Devices friendly
- Ground Plane Dependent
- Easy Integration
- Size smart and elegant
- Different colors available upon request

#### Installation and Durability

This 2J0B24 series is available in two configurations: a straight, right-angle SMA-Male standard connectors allowing the mounting in any space restriction installation. For direct sunlight applications, the production material used is black ABS UV stable, protecting the antenna from a temperature of -40C to 85C. This antenna was built with a complete RoHS compliance manufacturing process.

## 2. Antenna and electrical specifications

Parameters	CELLULAR / LTE Antenna		
<b>Standards</b>	2G, 3G and 4G		
<b>Technologies</b>	GSM, CDMA, DCS, PCS, GPRS, WCDMA, UMTS, HSPA, EVDO and LTE		
<b>Band (MHz)</b>	700/850/900	1710/1800/1900/2100	2600
<b>Frequency (MHz)</b>	698-960	1710-2170	2500-2700
<b>Return Loss (dB)</b>	~-5.8	~-13.9	~-3.6
<b>VSWR</b>	~3.5:1	~2.1:1	~5.5:1
<b>Efficiency (%)</b>	~66.6	~66.1	~25.8
<b>Peak Gain (dBi)</b>	~-0.9	~-2.7	~-1.5
<b>Average Gain (dB)</b>	~-1.9	~-1.8	~-6.1
<b>Impedance (Ohm)</b>	50		
<b>Polarisation</b>	Linear		
<b>Radiation Pattern</b>	Omni-Directional		
<b>Max. Input Power (W)</b>	25		
<b>Connector Type</b>	SMA-Male Standard (Right-Angle)		

### Antenna Measurement Conditions:

Mounted on Ground Plane of 115x45 mm

Measured in Certified CTIA 3D Anechoic Chamber

## 3. Mechanical and environmental specifications

Specifications	2J0B24-C884G
<b>Mounting Type</b>	Connector Mount
<b>Dimensions (mm)</b>	44 × 19.1 × 9
<b>Radome</b>	TPC-ET
<b>Radome color</b>	Black
<b>Operating Temperature (C)</b>	-40 to +85
<b>Storage Temperature (C)</b>	-40 to +85
<b>Substance Compliance</b>	RoHS

## 4. Antenna parameters

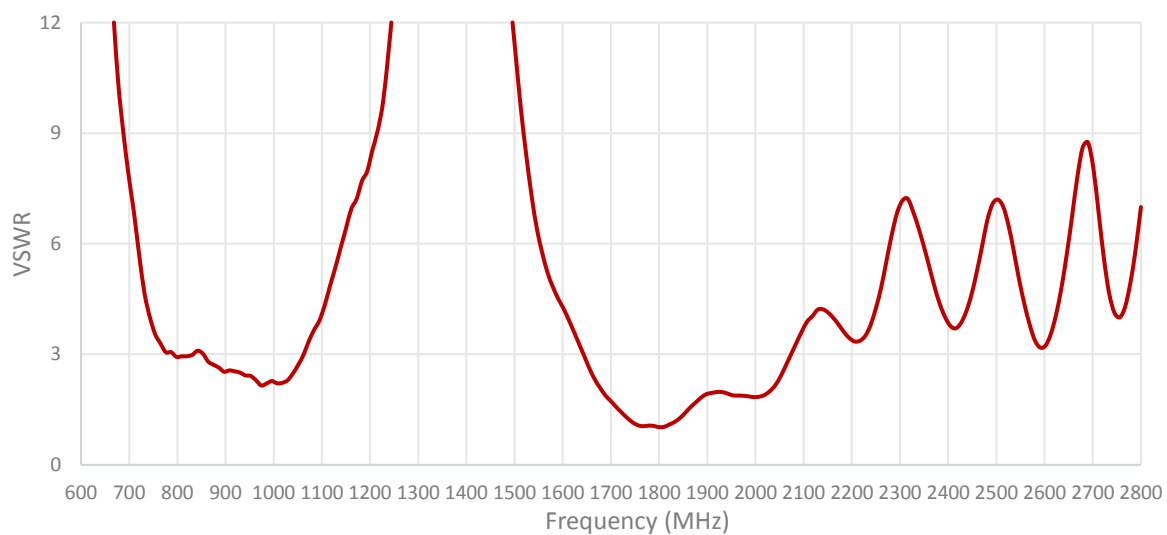
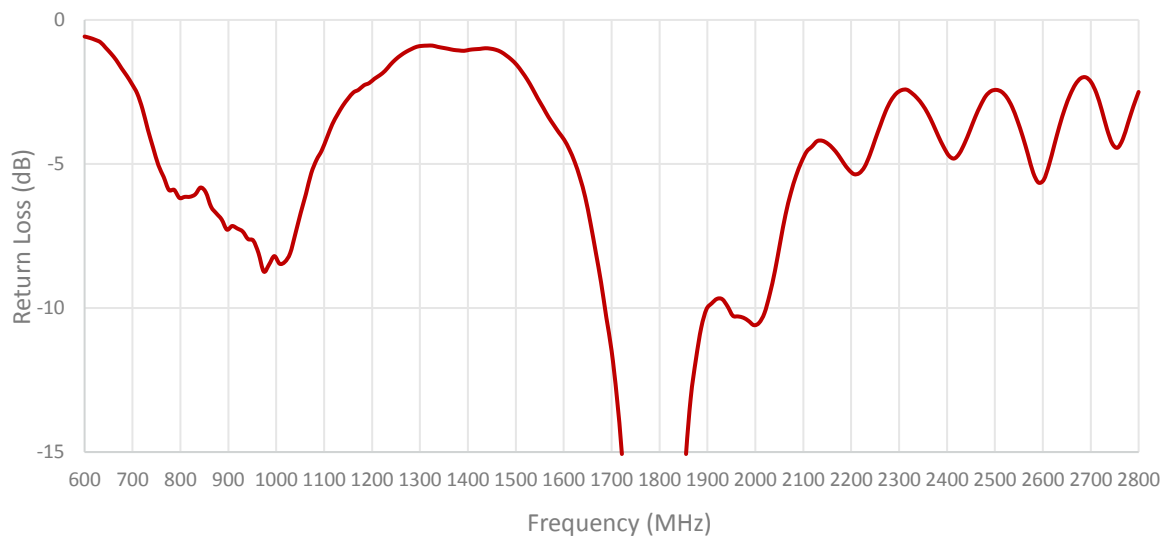

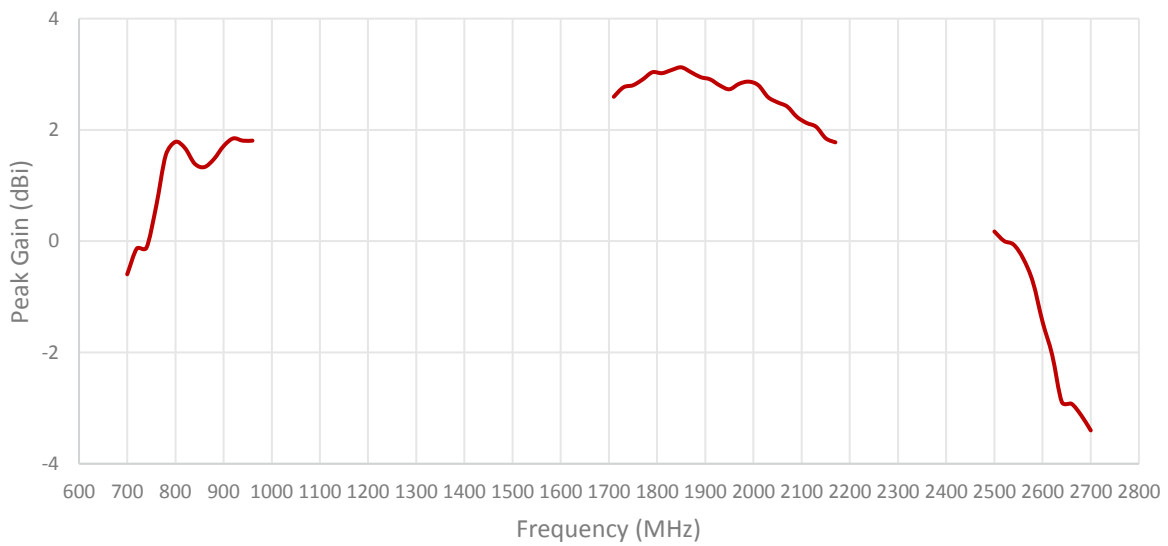
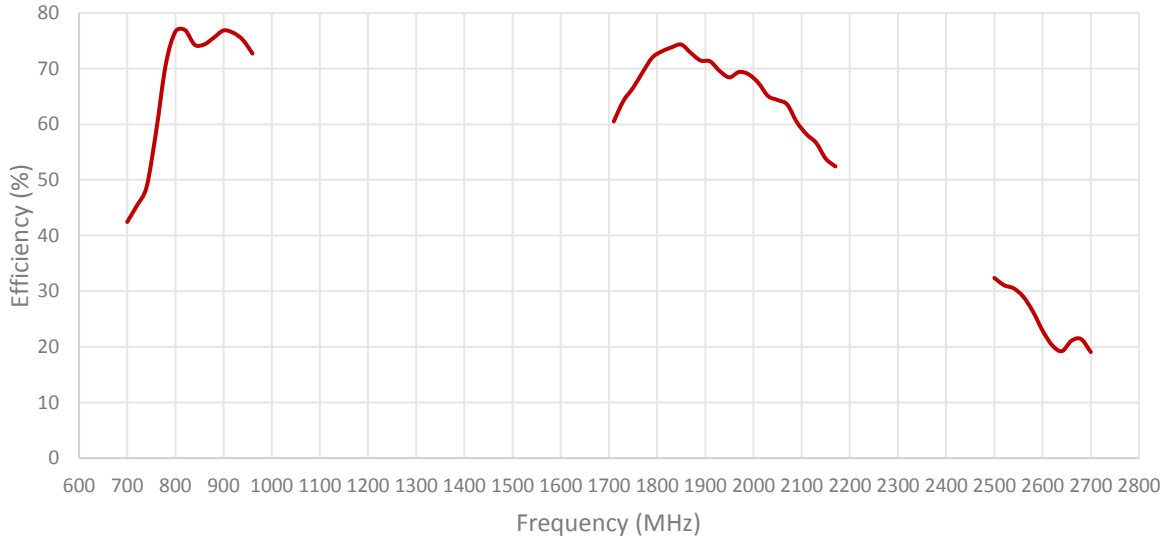

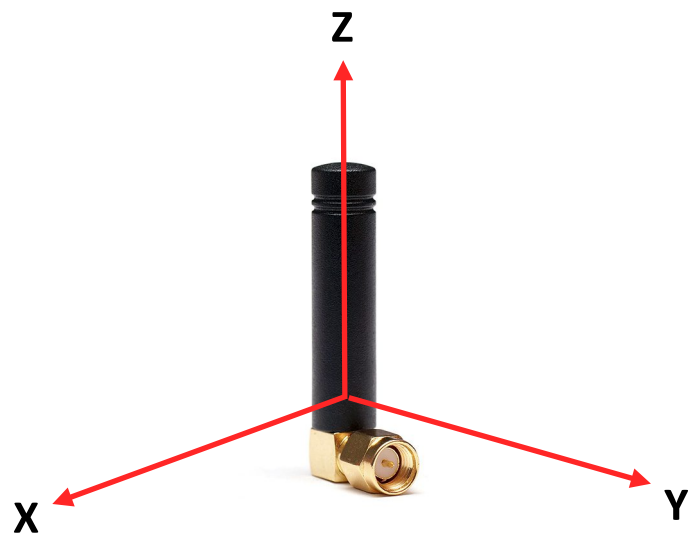
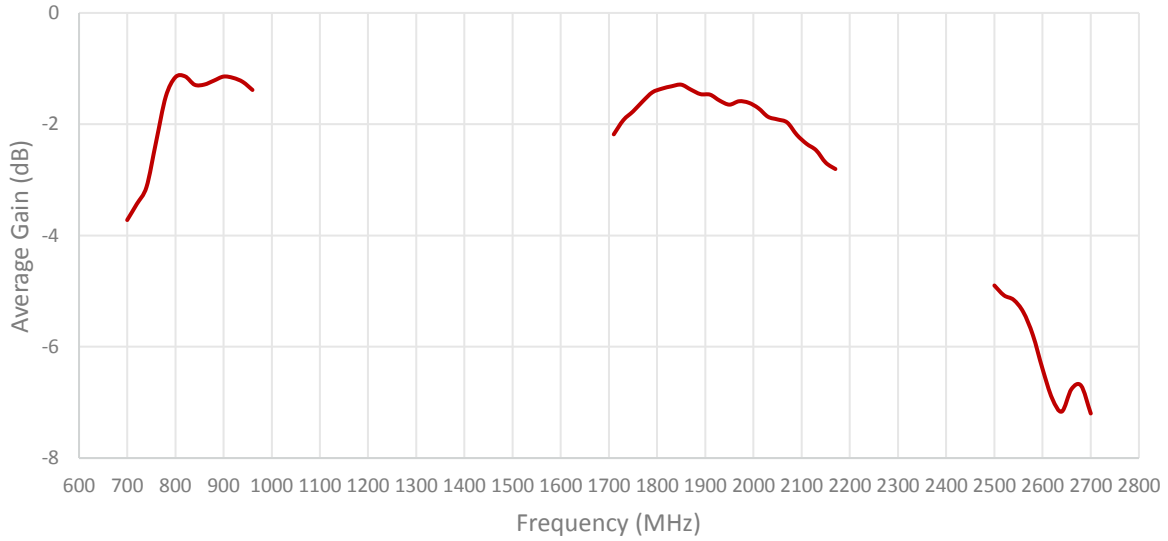

Radiation pattern reference

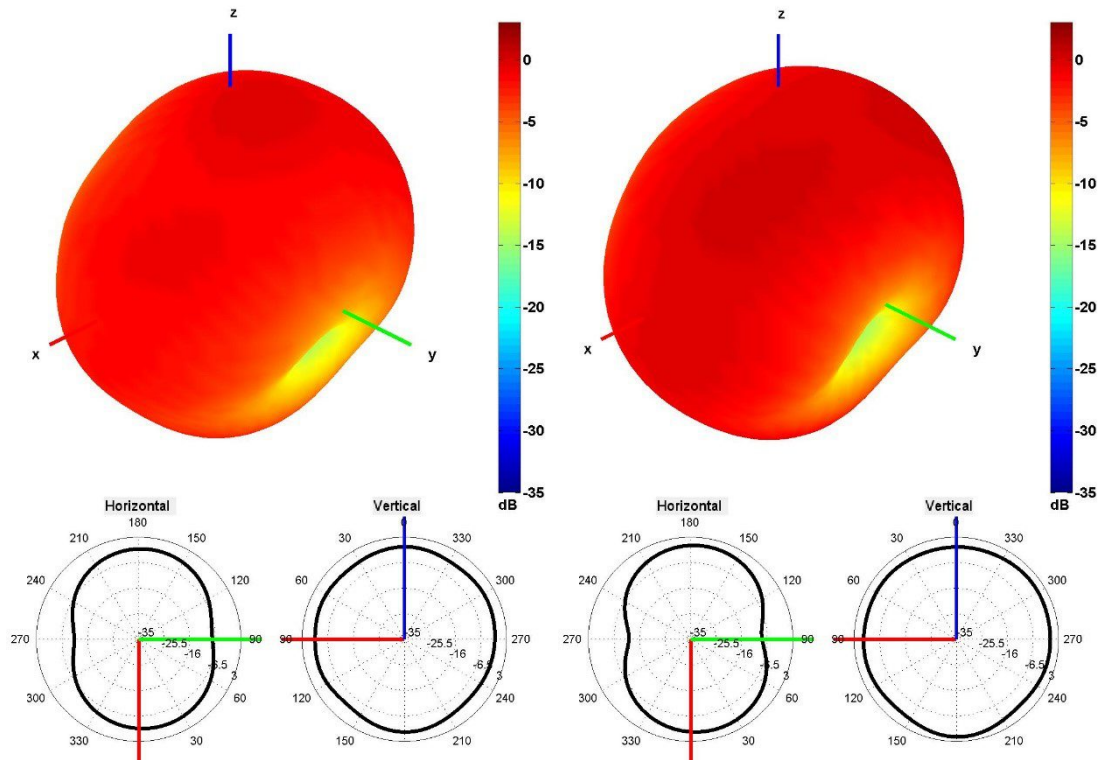

750 and 850 MHz Radiation pattern

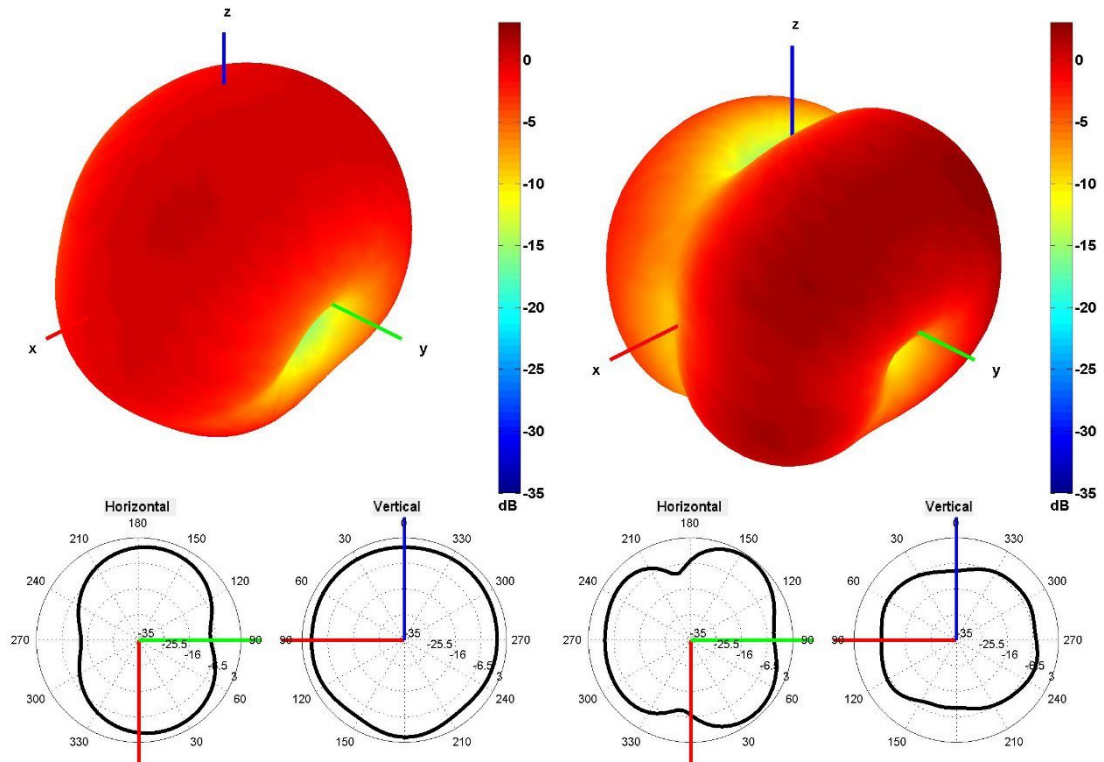

940 and 1750 MHz Radiation pattern

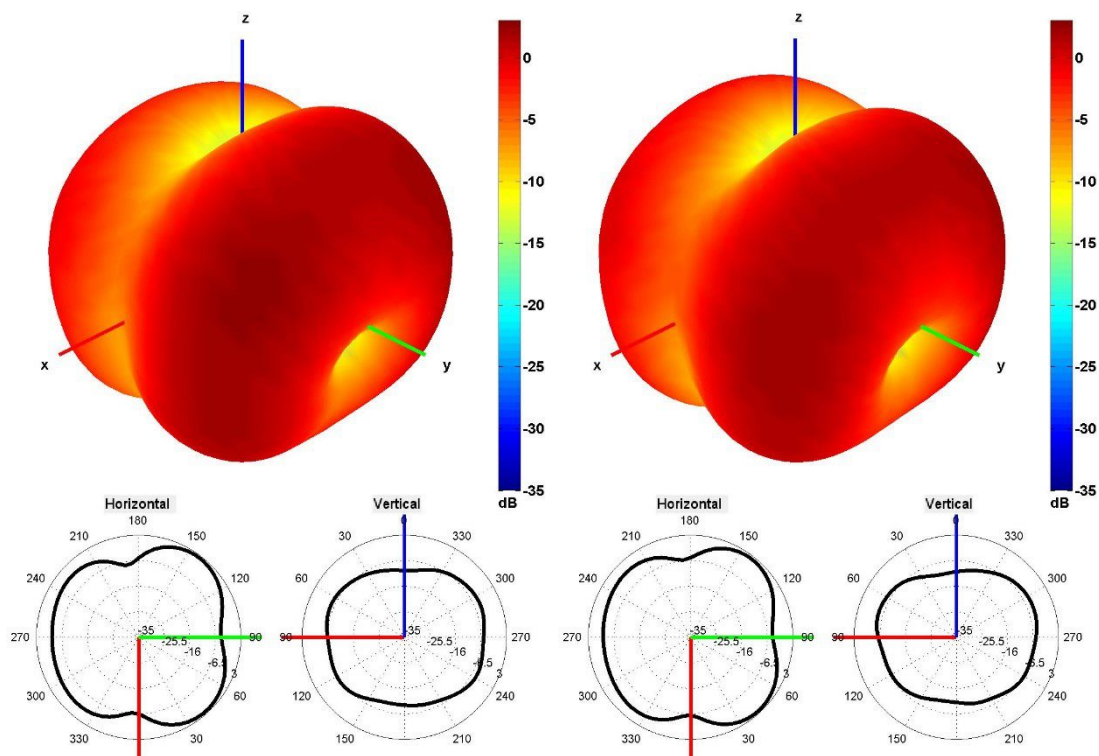

1850 and 1950 MHz Radiation pattern

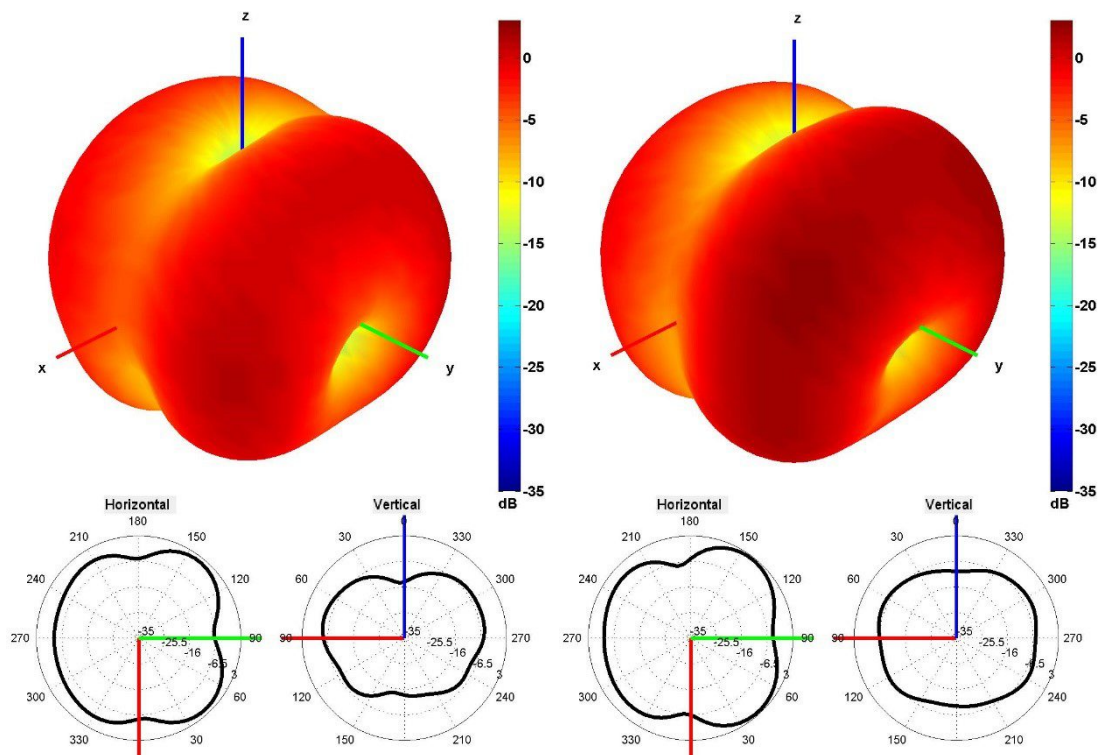

2100 and 2600 MHz Radiation pattern



## 5. Antenna drawings

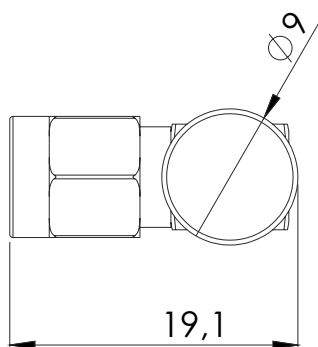
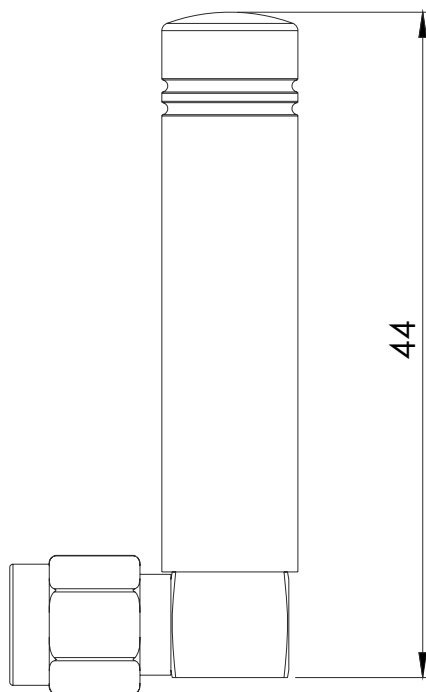

## 6. Antenna Images



## X-ON Electronics

Largest Supplier of Electrical and Electronic Components

*Click to view similar products for [Antennas](#) category:*

*Click to view products by [2J](#) manufacturer:*

Other Similar products are found below :

[930-033-R](#) [EXE902SM](#) [APAMPG-117](#) [66089-2406](#) [A09-F8NF-M](#) [A09-F5NF-M](#) [RGFRA1903041A1T](#) [108-00016-050](#) [W3525BW100](#)  
[SIMNA-868](#) [SIMNA-915](#) [SIMNA-433](#) [W1049B090](#) [TRABT1560](#) [WTL2449CQ1-FRSMM](#) [CPL9C](#) [0600-00060](#) [Y4503](#) [PAL90209H-FNF](#)  
[GD53-25](#) [C37](#) [MAF94051](#) [S9025PLSMF](#) [EXD420PL](#) [QWFTB120](#) [MAF94300](#) [FG4403](#) [MIKROE-2393](#) [GPSCPMM00](#) [ANTDOM-05-01-](#)  
[WPM](#) [ANT-WP868SMA-Y](#) [EXW30BNX](#) [RAD-ISM-2459-ANT-FOOD-6-0-](#) [S4908WBFNM](#) [GD57-21](#) [108-20131-010](#) [108-00032-010](#)  
[C27S](#) [CBNC58](#) [EXH160MXI](#) [EXH160SFK](#) [MD10-004](#) [EXC902SM](#) [CB27](#) [ABFT](#) [BB4502NR](#) [B4502N](#) [S4908WBFNF](#) [ANT-](#)  
[GSMGPSPUKS](#) [60210](#)