

2J3524M

CELLULAR / LTE Magnetic Mount

Key Features

CELLULAR / LTE

- 698-960 MHz
- 1710-2170 MHz
- 2500-2700 MHz

Magnetic Mount

High Performance

Ground Plane Dependent

Customizable Cable and Connector

Dimensions $\varnothing 31 \times 94$ mm



1. Antenna and electrical specifications

Parameters	CELLULAR / LTE Antenna		
Standards	2G,3G and 4G		
Band (MHz)	700/850/900	1700/1800/1900/2100	2600
Frequency (MHz)	698-960	1710-2170	2500-2700
Return Loss (dB)	~-12.3	~-12.2	~-11.0
VSWR	~1.7:1	~1.7:1	~1.8:1
Efficiency (%)	~69.5	~54.3	~51.1
Peak Gain (dBi)	~-2.2	~-2.2	~-2.7
Average Gain (dB)	~-1.6	~-2.7	~-2.9
Impedance (Ohm)	50		
Polarisation	Linear		
Radiation Pattern	Omni-Directional		
Max. Input Power (W)	35		
Connector Type	SMA-Male Standard (Other Connectors Available)		
Cable Length	300 cm Standard (Any Cable Length Available)		
Cable Type	LL100 Standard (Other Cables Available)		

Antenna Measurement Conditions:

Mounted on 30 x 30 cm Metal Plate

200 cm of Cable LL100

Measured in Certified CTIA 3D Anechoic Chamber

2. Mechanical and environmental specifications

Specifications	2J3524M
Mounting Type	Magnetic Mount
Dimensions (mm)	Ø 31 × 94
Radome color	Black
Antenna Base	PP
Whip Material	Brass
Operating Temperature (C)	-40 to +85
Storage Temperature (C)	-40 to +85
Substance Compliance	RoHS

3. Antenna parameters

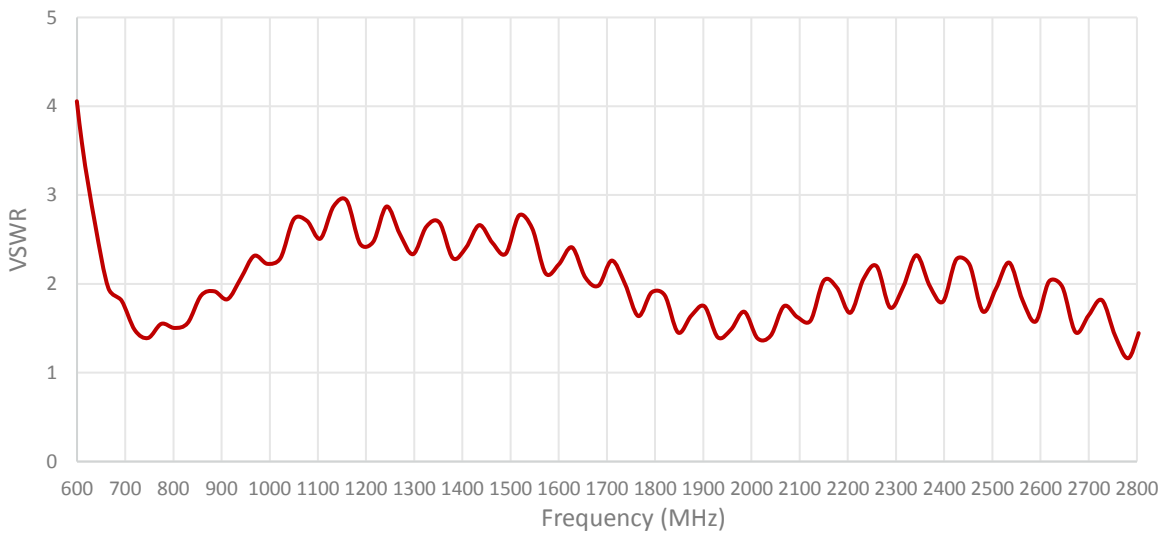
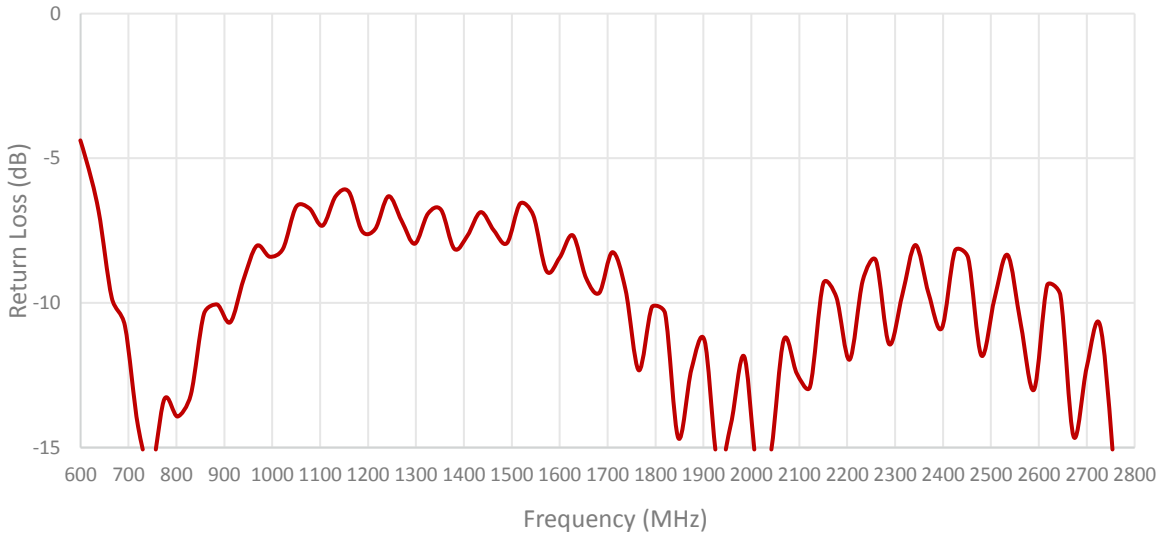

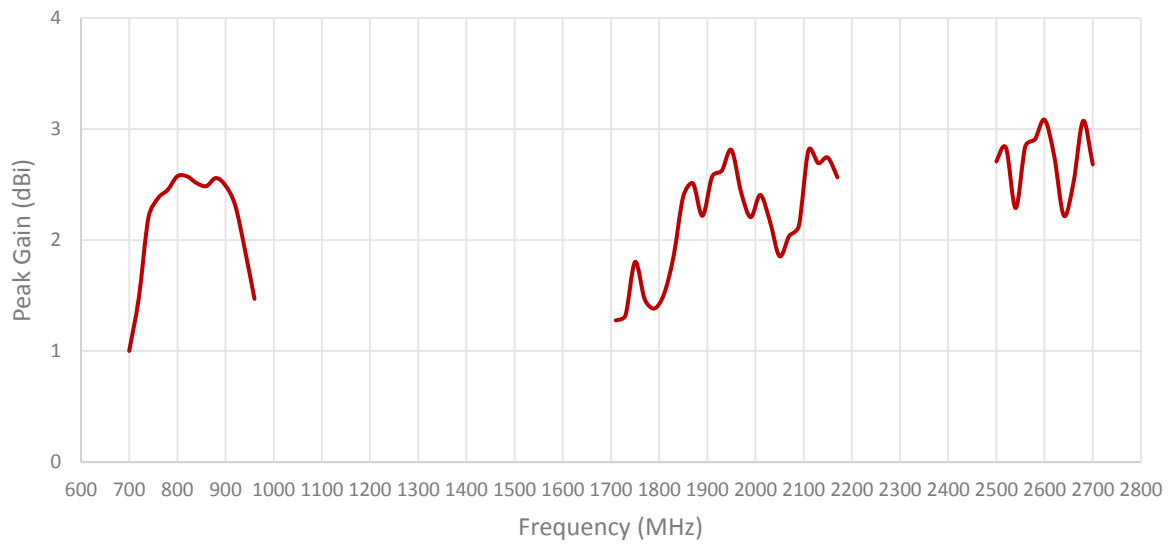
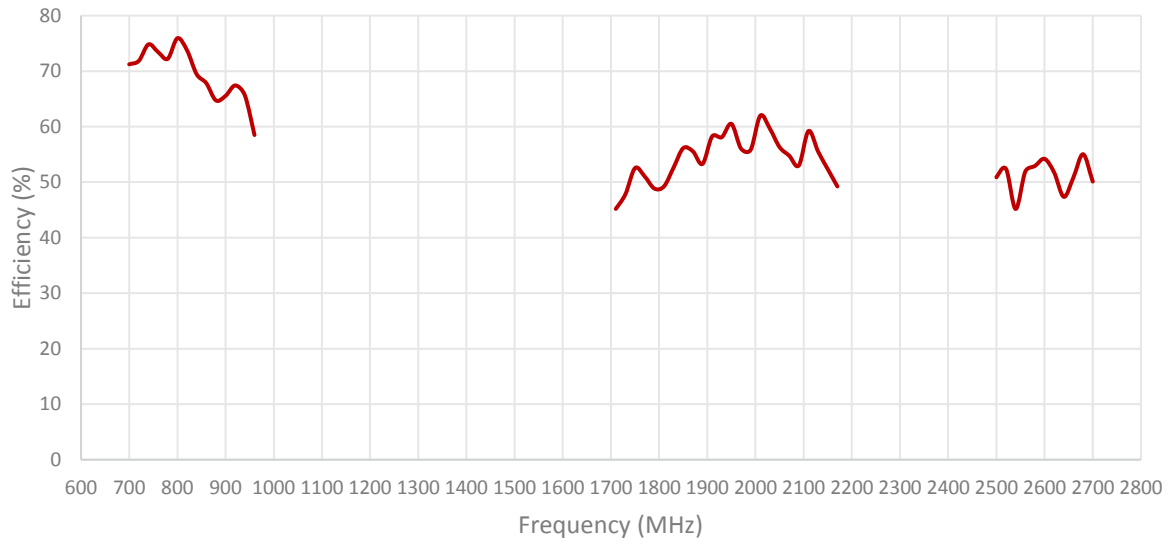

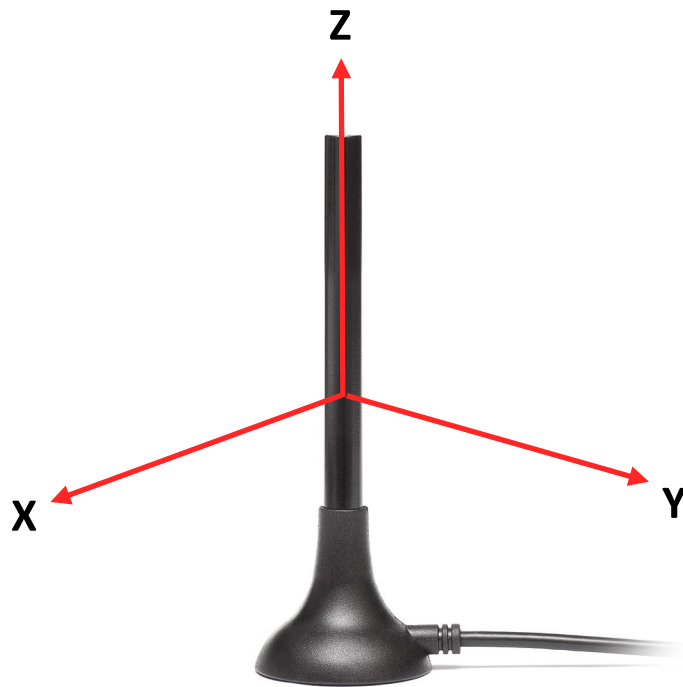
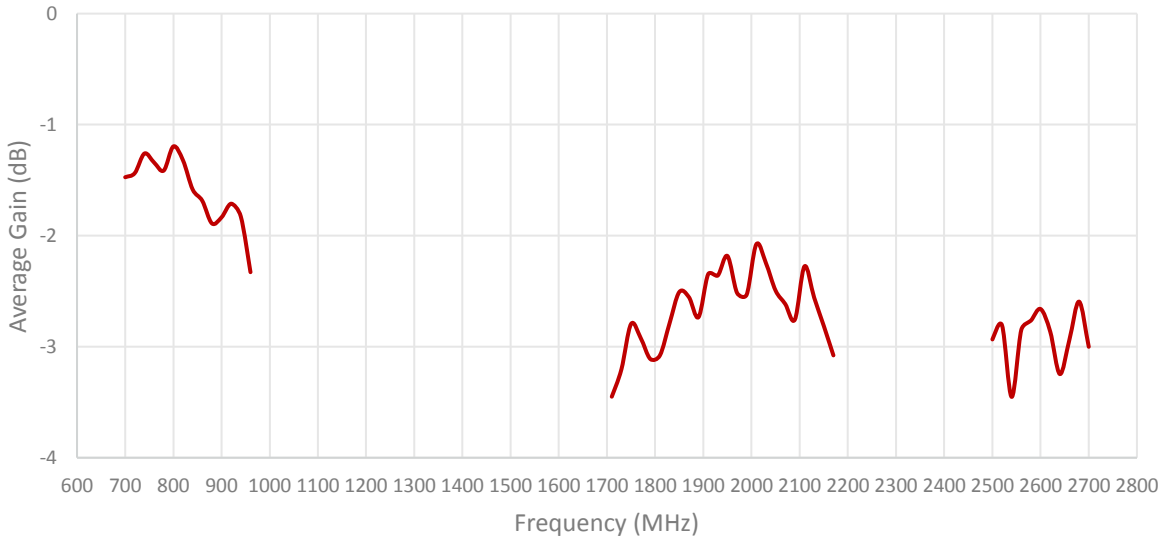

Radiation pattern reference

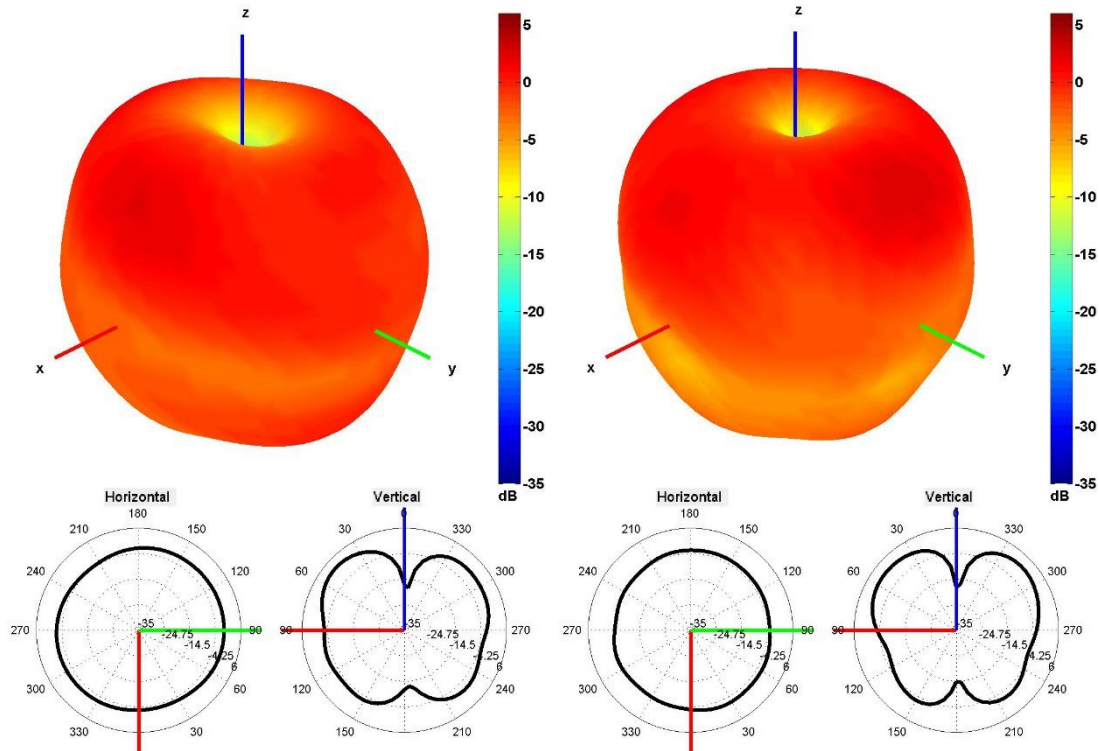

750 and 850 MHz Radiation pattern

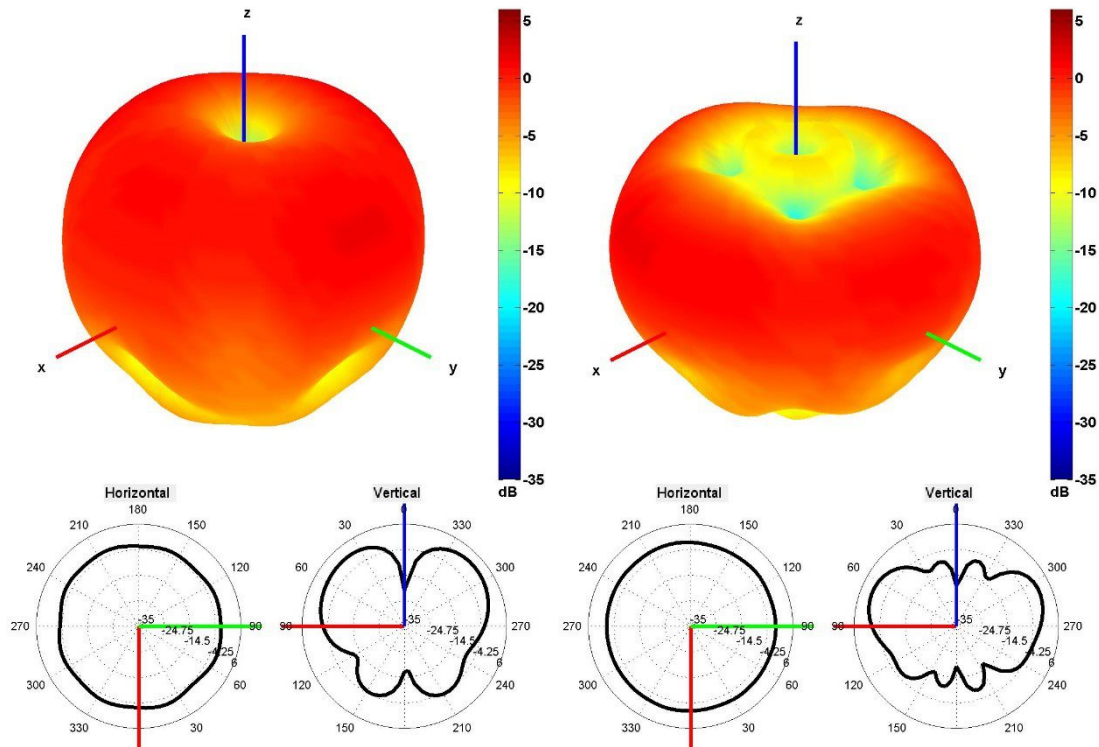

940 and 1750 MHz Radiation pattern

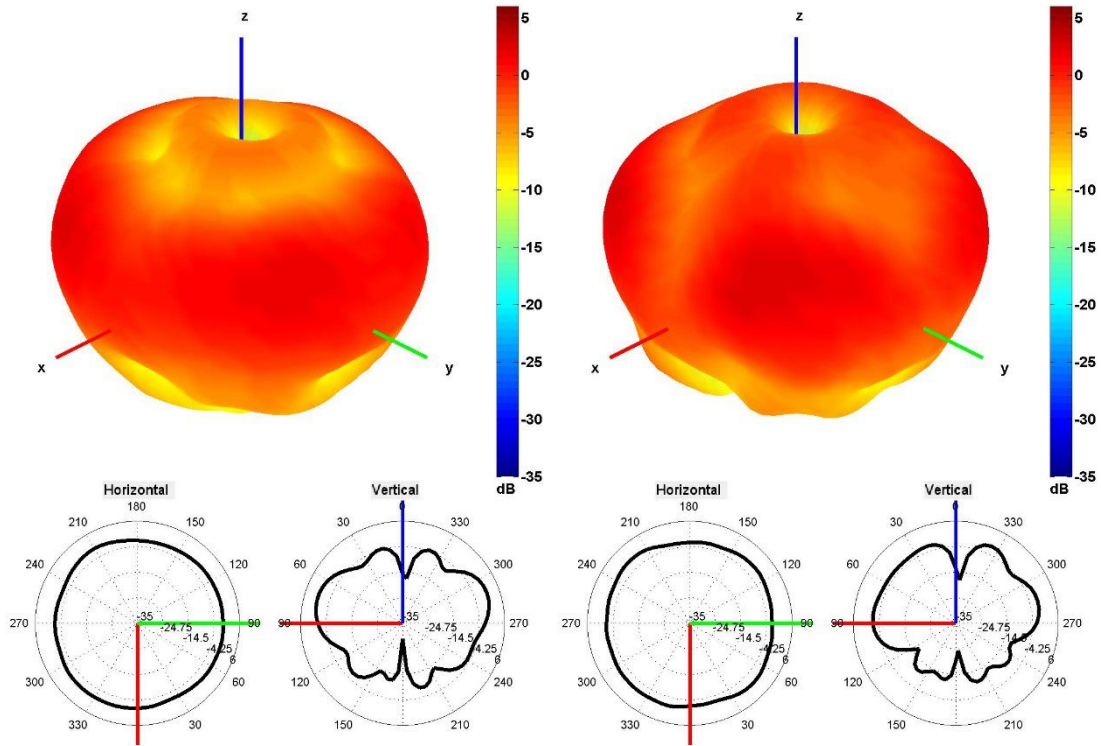

1850 and 1950 MHz Radiation pattern

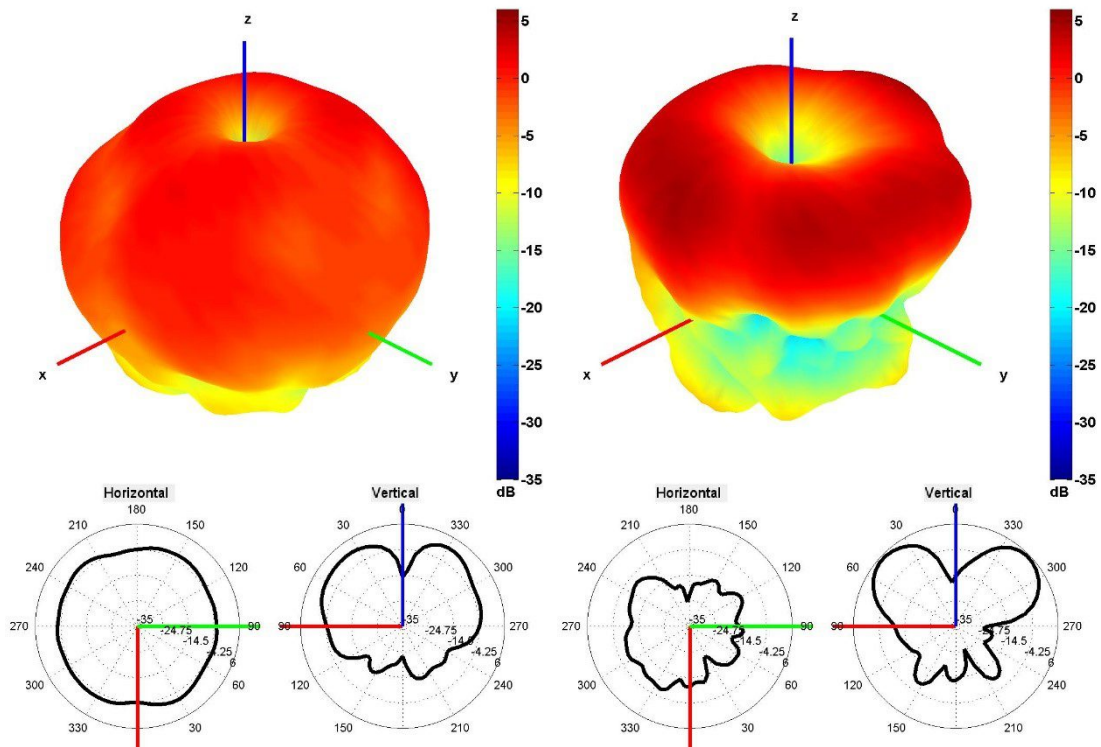

2100 and 2600 MHz Radiation pattern

4. Antenna drawings

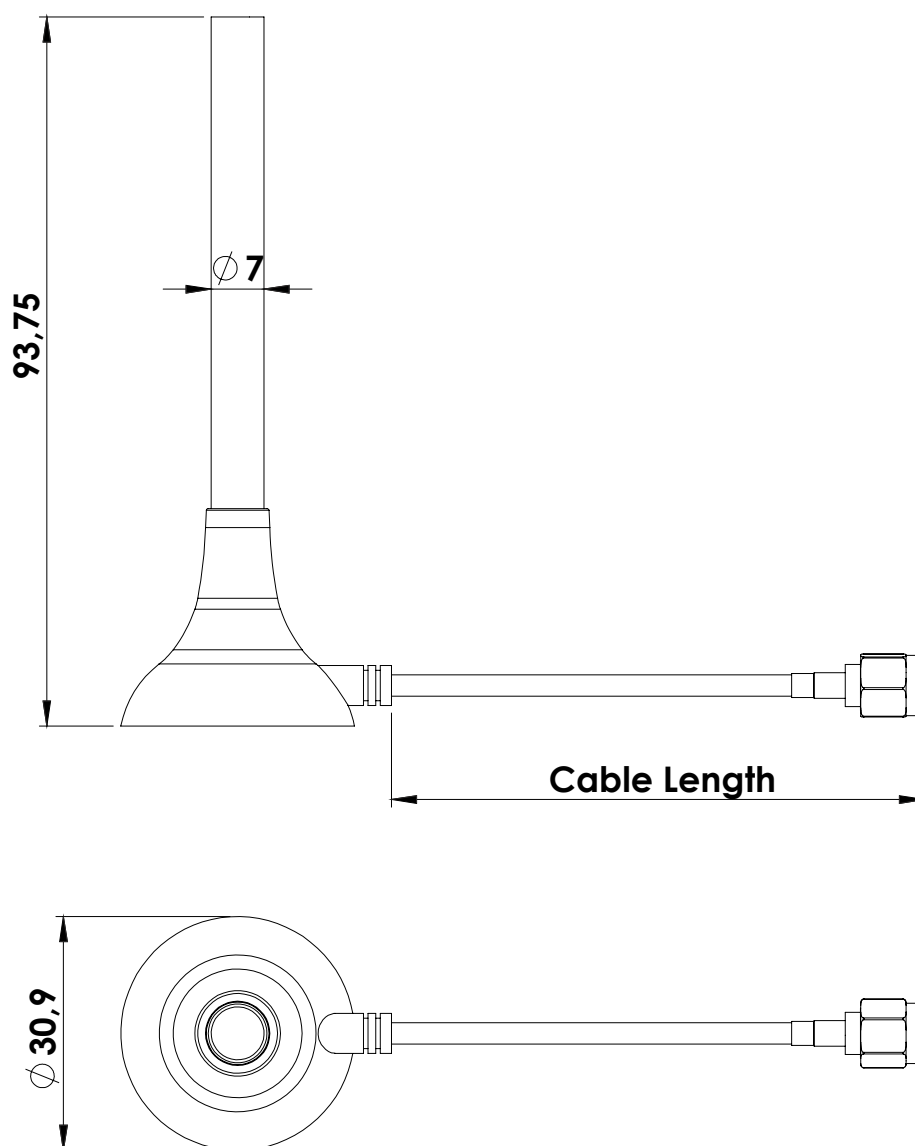

5. Antenna Images



X-ON Electronics

Largest Supplier of Electrical and Electronic Components

Click to view similar products for [Antennas](#) category:

Click to view products by [2J](#) manufacturer:

Other Similar products are found below :

[GAN30084EU](#) [930-033-R](#) [GW17.07.0250E](#) [1513563-1](#) [EXE902SM](#) [APAMPG-117](#) [MAF94383](#) [W3908B0100](#) [W6102B0100](#) [YE572113-30RSMM](#) [108-00014-50](#) [66089-2406](#) [SPDA17RP918](#) [A09-F8NF-M](#) [A09-F5NF-M](#) [RGFRA1903041A1T](#) [W3593B0100](#) [W3921B0100](#) [SIMNA-868](#) [SIMNA-915](#) [SIMNA-433](#) [W1044](#) [W1049B090](#) [A75-001](#) [WTL2449CQ1-FRSMM](#) [CPL9C](#) [EXB148BN](#) [0600-00060](#) [TRA9020S3PBN-001](#) [GD5W-28P-NF](#) [MA9-7N](#) [GD53-25](#) [GD5W-21P-NF](#) [C37](#) [MAF94051](#) [MA9-5N](#) [EXD420PL](#) [B1322NR](#) [QWFTB120](#) [MAF94300](#) [GPSMB301](#) [FG4403](#) [AO-AGSM-OM54](#) [5200232](#) [MIKROE-2349](#) [WCM.01.0111](#) [MIKROE-2393](#) [MIKROE-2352](#) [MIKROE-2350](#) [5200227](#)