

## 2J5083P

### 5GNR Adhesive Mount

#### Key Features

##### 5G NR

- 617-960 MHz
- 1427-2690 MHz
- 3300-5000 MHz
- 5150-5925 MHz

Adhesive Mount

Ground Plane Independent

Customizable Cable and Connector

Dimensions 116 x 22 x 6.7 mm



## 1. Antenna and electrical specifications

Parameters	5GNR Antenna			
<b>Technologies</b>	5G, 4G, 3G and 2G			
<b>Standards</b>	5GNR/4GLTE/FirstNet/CBRS/LPWA/CAT-X/CAT-Mx/CAT-NBx/NB-IoT/3G/2G			
<b>Frequency (MHz)</b>	617-960	1427-2690	3300-5000	5150-5925
<b>Band (MHz)</b>	600, 700, 850, 900	1500, 1600, 1700, 1800, 1900, 2000, 2100, 2300, 2500, 2600	3300, 3500, 3600, 3700, 4500	5200, 5500, 5800
<b>5GNR Bands</b>	n5, n8, 12, n20, n28, n71, n81, n82, n83,	n1, n2, n3, n7, n25, n34, n38, n39, n40, n41, n50, n51, n66, n70, n74, n75, n76, n80, n84, n86	n77, n78, n79	
<b>4GLTE Bands</b>	B5, B6, B8, B12, B13, B14, B17, B18, B19, B20, B26, B27, B28, B29, B44, B67, B68, B71, B85	B1, B2, B3, B4, B7, B9, B10, B11, B21, B23, B24, B25, B30, B32, B33, B34, B35, B36, B37, B38, B39, B40, B41, B45, B50, B51, B65, B66, B69, B70, B74, B75, B76	B22, B42, B43, B48, B49, B52	B46, B47, B252, B255
<b>3GCELL Bands</b>	B5, B6, B8, B12, B13, B14, B19, B20, B26	B1, B2, B3, B4, B7, B9, B10, B11, B21, B25, B32, B33, B34, B35, B36, B37, B38, B39, B40	B22	
<b>2GCELL Bands</b>	710, 750, 810T, 850, 900P, 900E, 900R	1800DCS, 1900PCS		
<b>CDMACELL Bands</b>	BC0, BC2, BC3, BC7, BC9, BC10, BC12, BC18, BC19	BC1, BC4, BC6, BC8, BC13, BC14, BC15, BC16, BC20, BC21		
<b>Return Loss (dB)</b>	~-15.3	~-12.8	~-12.1	~-15.6
<b>VSWR</b>	~1.5:1	~1.7:1	~1.8:1	~1.5:1
<b>Efficiency (%)</b>	~60.1	~45.8	~24.5	~24.5
<b>Peak Gain (dBi)</b>	~3.2	~3.6	~1.0	~1.6
<b>Average Gain (dB)</b>	~-2.2	~-3.4	~-6.2	~-6.1
<b>Impedance (Ohm)</b>	50			
<b>Polarisation</b>	Linear			
<b>Radiation Pattern</b>	Omni-Directional			
<b>Max. Input Power (W)</b>	35			
<b>Connector Type</b>	SMA-Male Standard (Other Connectors Available)			
<b>Cable Length</b>	300 cm Standard (Any Cable Length Available)			
<b>Cable Type</b>	LL100 Standard (Other Cables Available)			

### Antenna Measurement Conditions:

Mounted on 30 x 30 x 0.25 cm ABS Plate

100 cm of LL100 Cable

Measured in Certified CTIA 3D Anechoic Chamber

## 2. Mechanical and environmental specifications

Specifications	2J5083P
<b>Mounting Type</b>	Adhesive Mount
<b>Dimensions (mm)</b>	116 x 22 x 6.7
<b>Radome Type</b>	PC/ABS UV Stable
<b>Radome color</b>	Black
<b>Operating Temperature (C)</b>	-40 to +85
<b>Storage Temperature (C)</b>	-40 to +85
<b>Substance Compliance</b>	RoHS

### 3. Antenna parameters

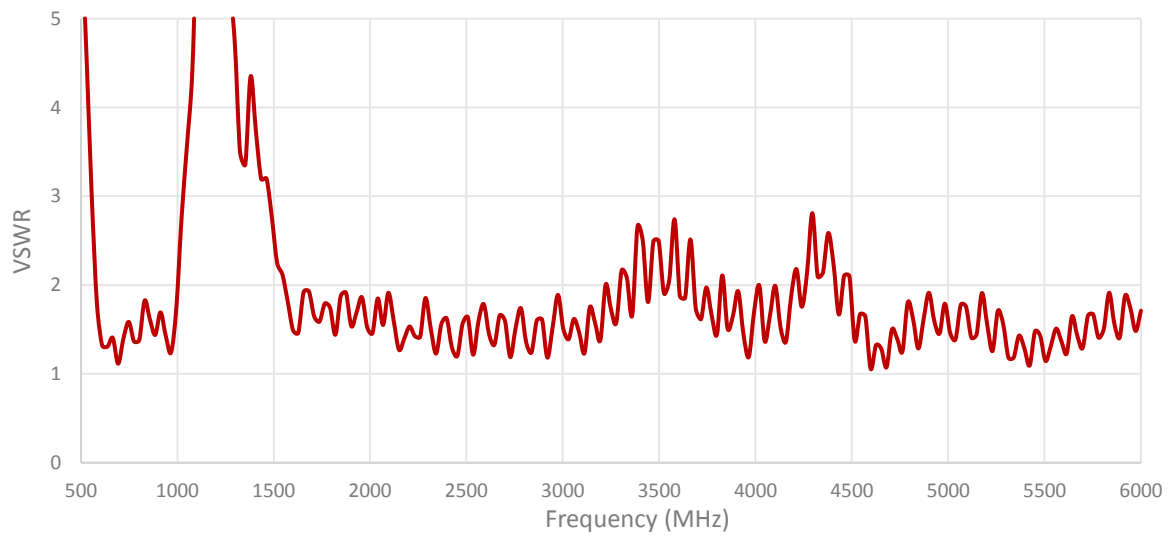
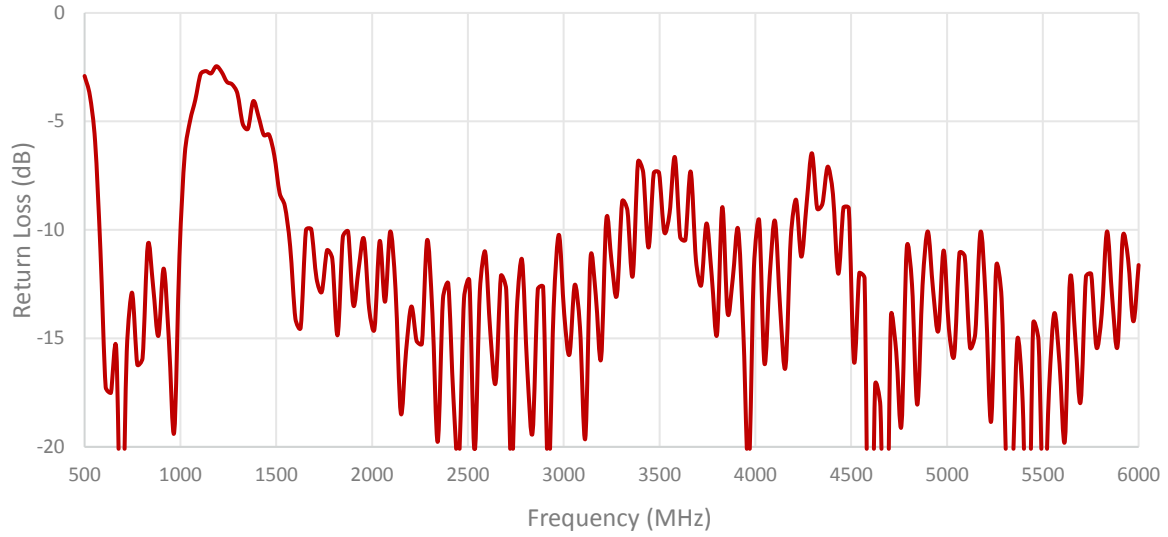

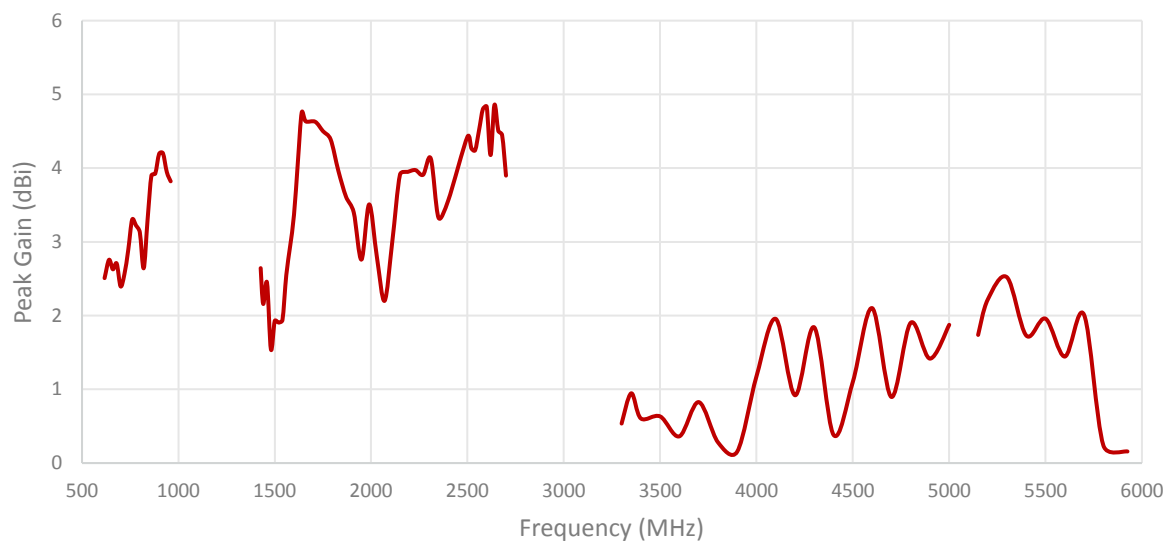
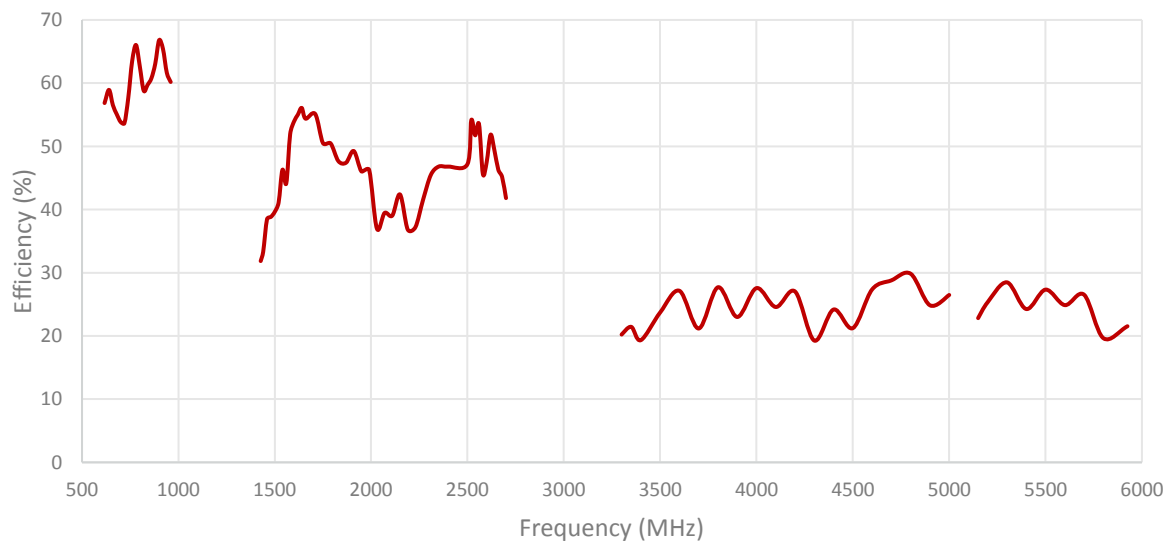

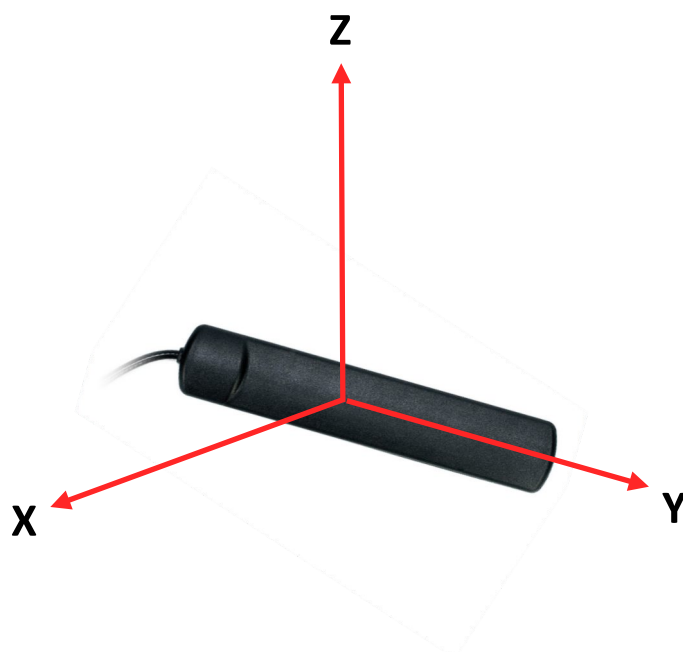
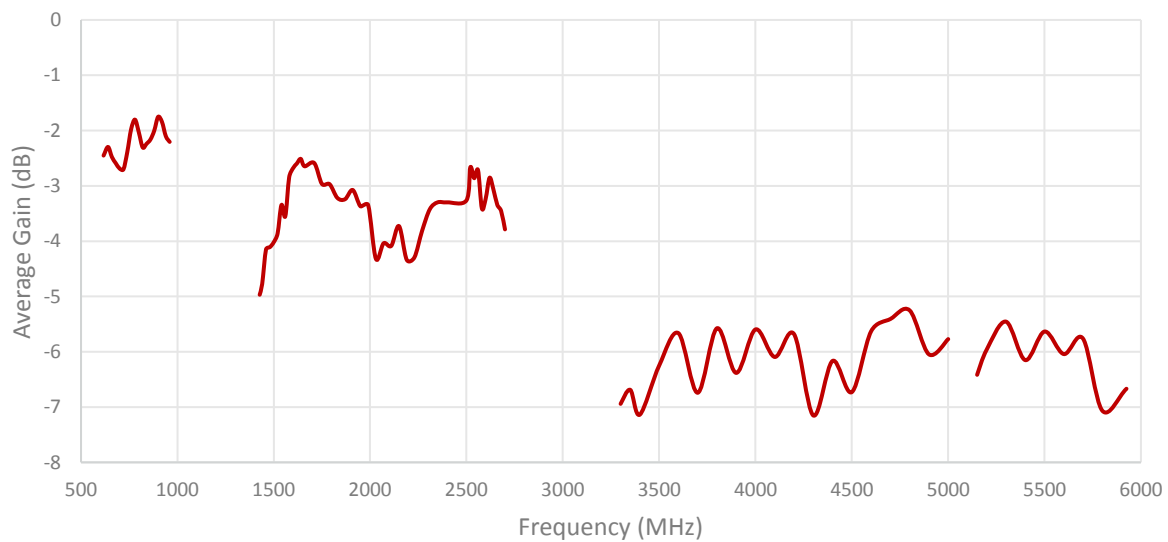

Radiation pattern reference

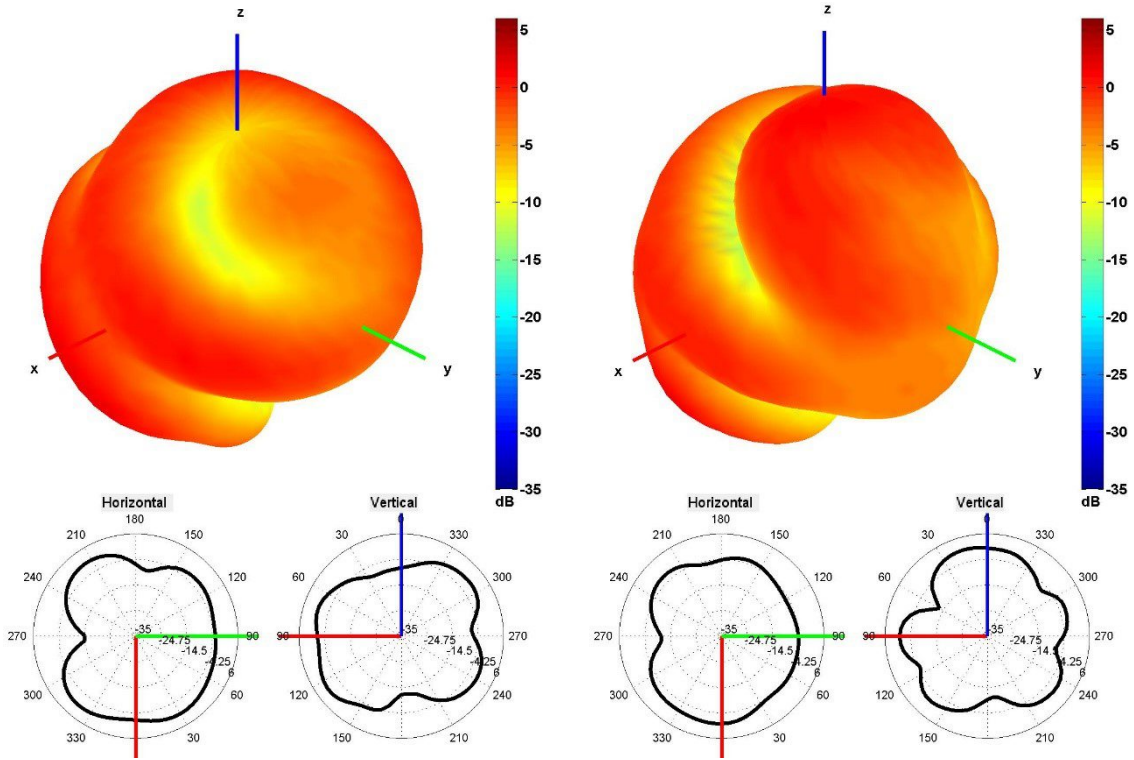

650 and 750 MHz Radiation pattern

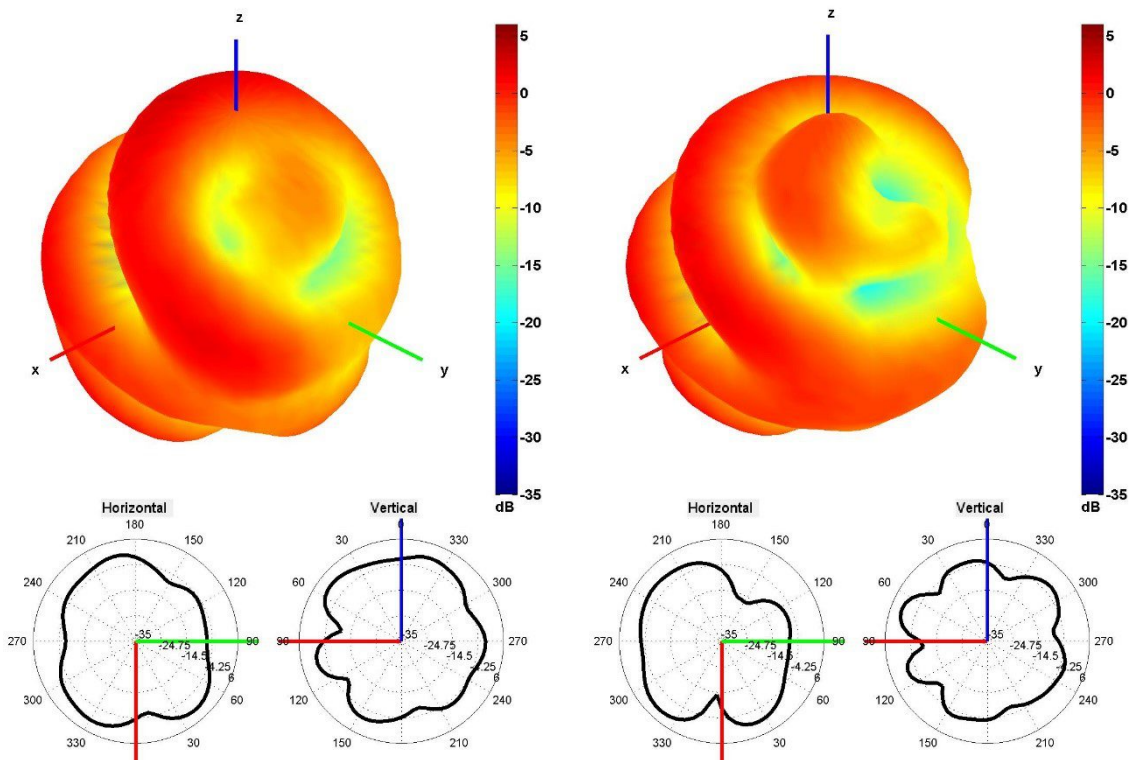

850 and 940 MHz Radiation pattern

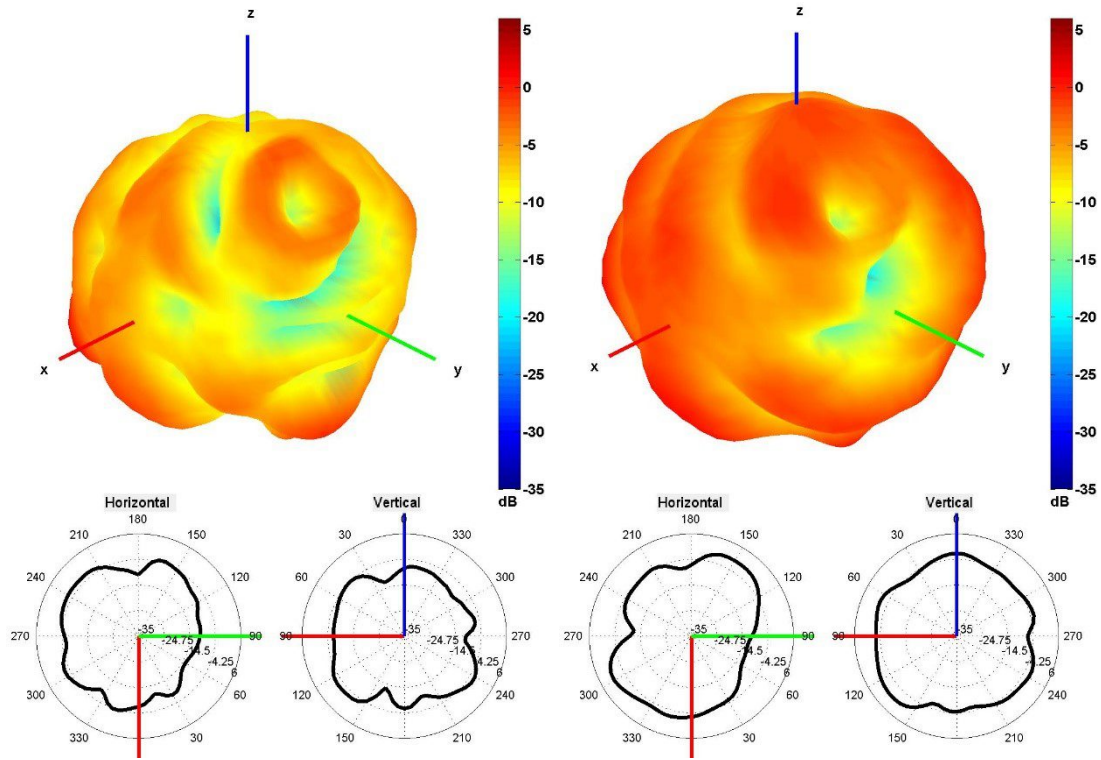

1500 and 1600 MHz Radiation pattern

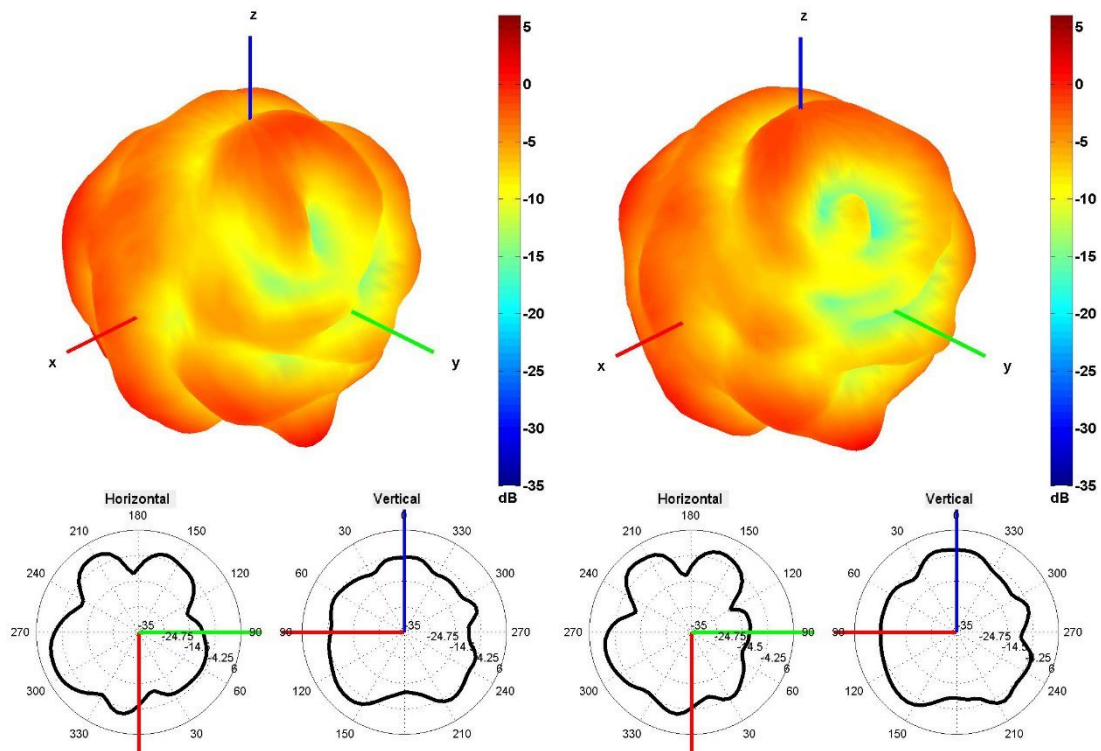

1750 and 1850 MHz Radiation pattern



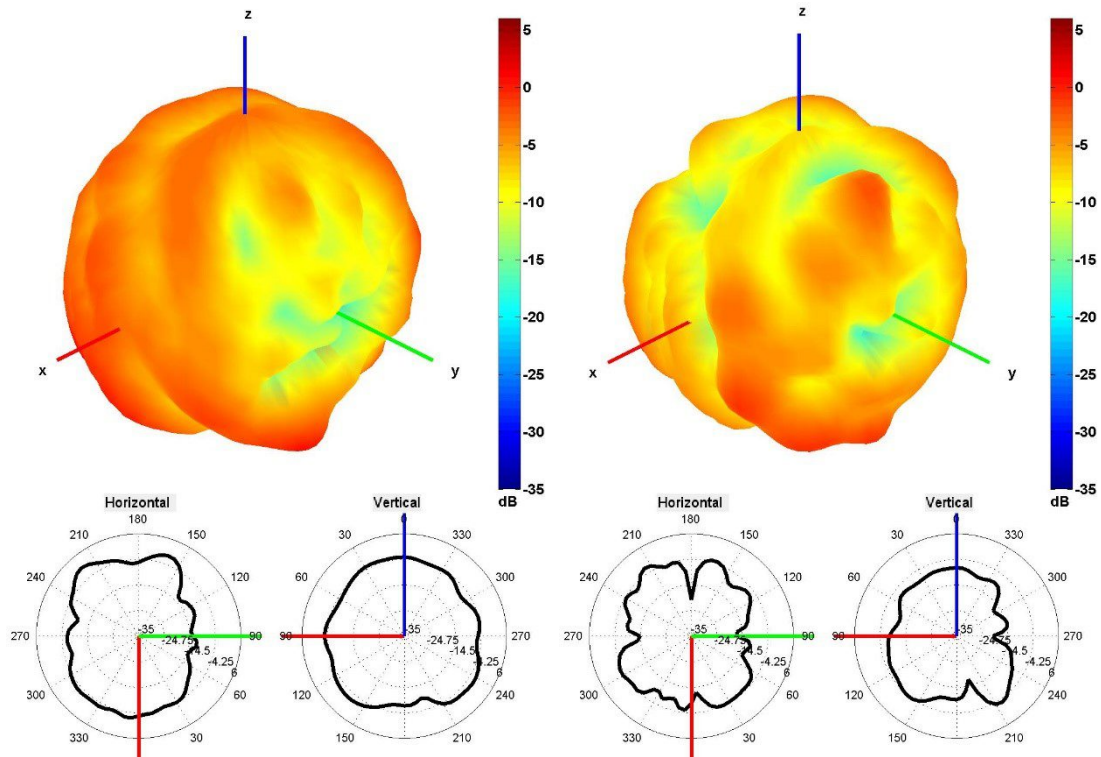

1950 and 2100 MHz Radiation pattern

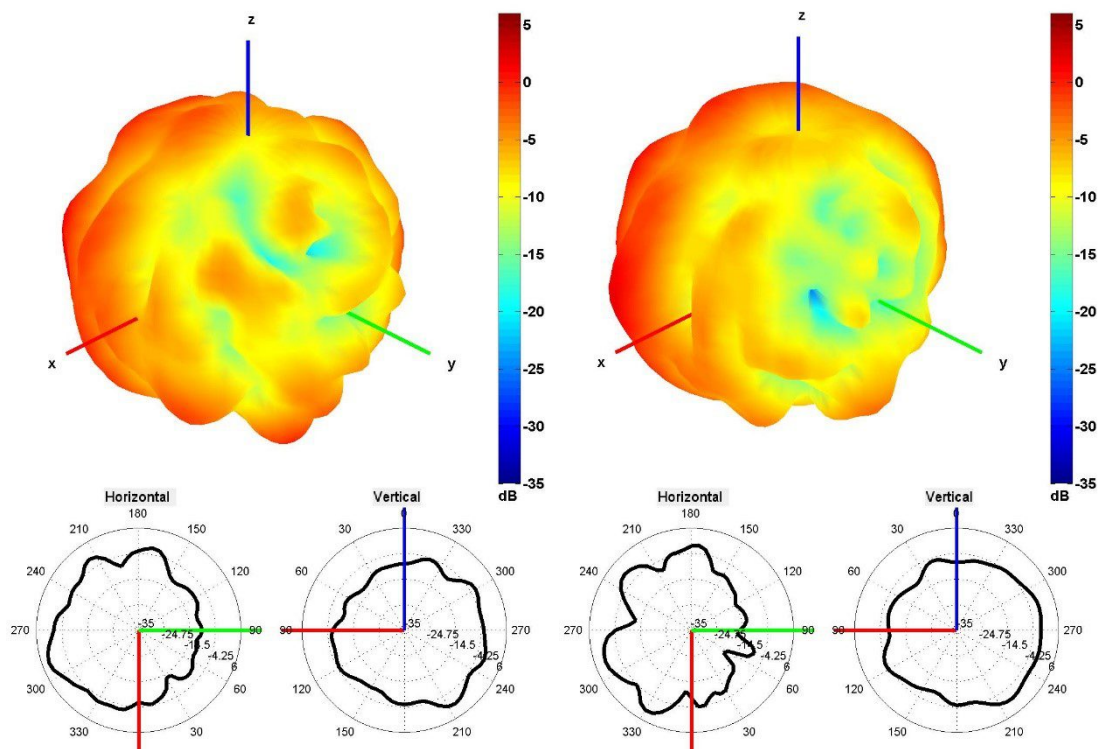

2350 and 2600 MHz Radiation pattern

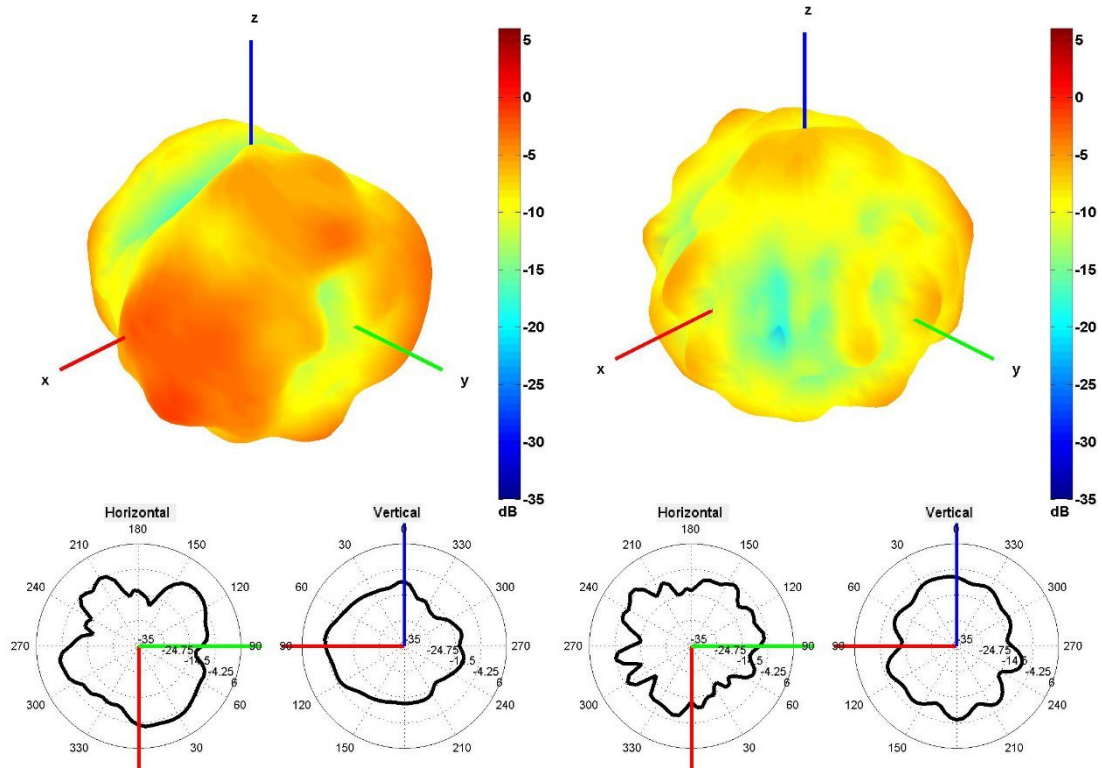

3350 and 3600 MHz Radiation pattern

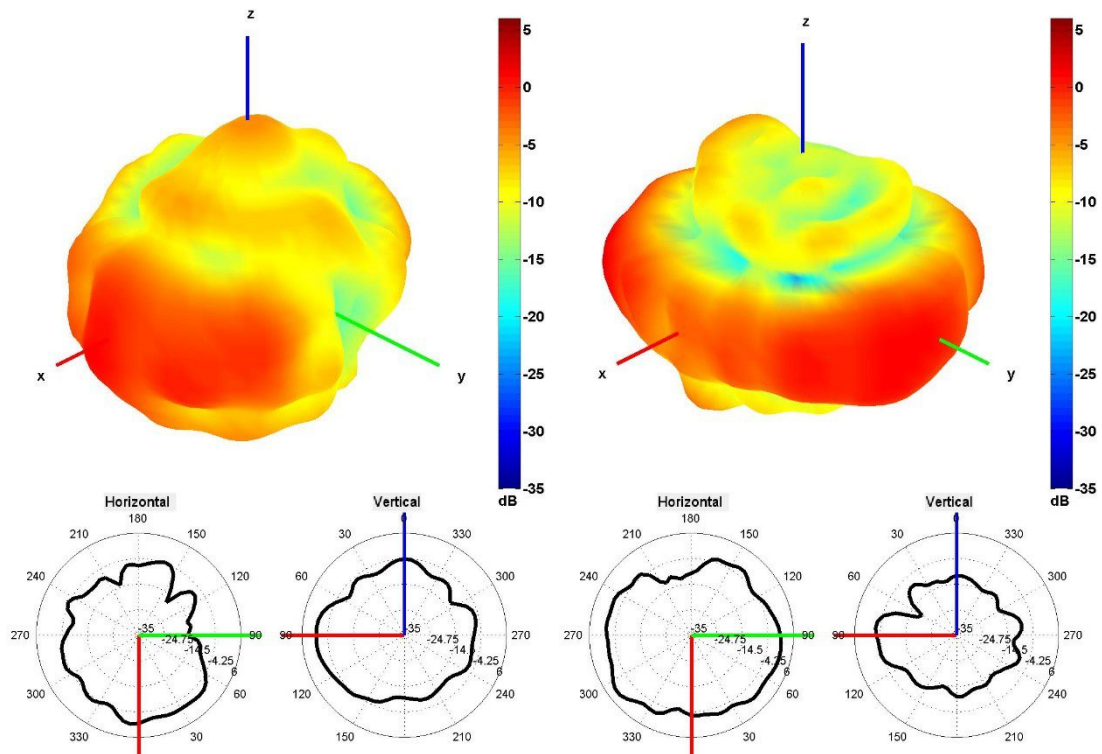

4500 and 5500 MHz Radiation pattern

## 4. Antenna drawings

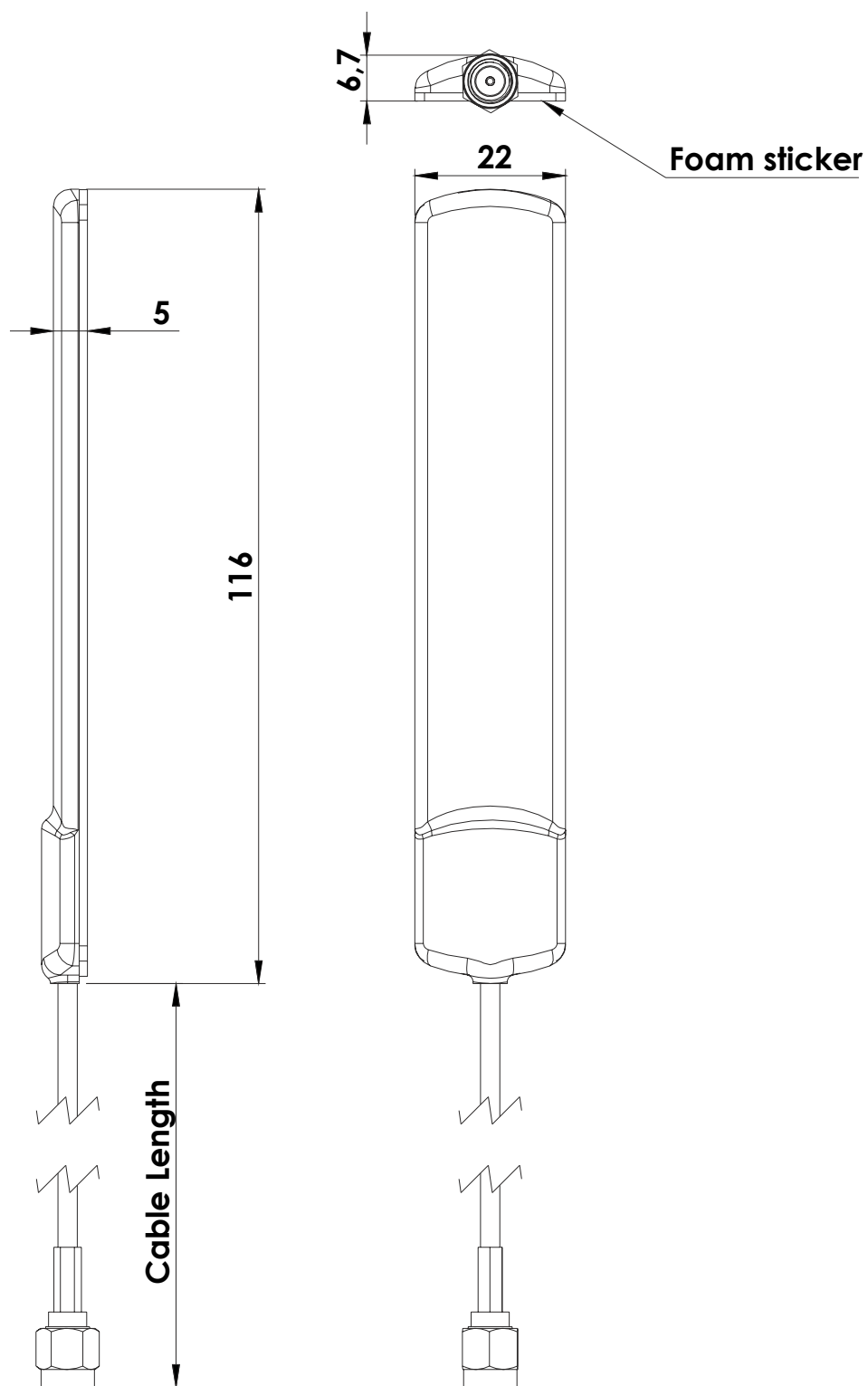

## 5. Antenna Images



## X-ON Electronics

Largest Supplier of Electrical and Electronic Components

*Click to view similar products for [Antennas](#) category:*

*Click to view products by [2J](#) manufacturer:*

Other Similar products are found below :

[930-033-R](#) [EXE902SM](#) [APAMPG-117](#) [108-00014-50](#) [66089-2406](#) [A09-F8NF-M](#) [A09-F5NF-M](#) [RGFRA1903041A1T](#) [108-00016-050](#)  
[SIMNA-868](#) [SIMNA-915](#) [SIMNA-433](#) [W1049B090](#) [TRABT1560](#) [WTL2449CQ1-FRSMM](#) [CPL9C](#) [0600-00060](#) [Y4503](#) [GD53-25](#) [C37](#)  
[MAF94051](#) [S9025PLSMF](#) [QWFTB120](#) [MAF94300](#) [FG4403](#) [MIKROE-2393](#) [GPSCPMM00](#) [ANTDOM-05-01-WPM](#) [ANT-WP868SMA-Y](#)  
[EXW30BNX](#) [RAD-ISM-2459-ANT-FOOD-6-0-](#) [S4908WBFNM](#) [B4305CN](#) [108-20131-010](#) [108-00032-010](#) [C27S](#) [CBNC58](#) [EXH160MXI](#)  
[EXH160SFK](#) [MD10-004](#) [EXC902SM](#) [CB27](#) [ABFT](#) [BB4502NR](#) [B4502N](#) [S4908WBFNF](#) [NMOCAPB](#) [60210](#) [60140](#) [60168](#)