

## 2J5124P

### CELLULAR / LTE Adhesive Mount

#### Key Features

##### CELLULAR / LTE

- 698-960 MHz
- 1710-2170 MHz
- 2500-2700 MHz

Adhesive Mount

Flexible Housing

Compact Size

High Performance

Optional Antenna Detection Resistor

Customizable Cable and Connector

Dimensions 122 x 14 x 6 mm



## 1. Antenna and electrical specifications

Parameters	CELLULAR / LTE Antenna		
<b>Standards</b>	2G,3G and 4G		
<b>Band (MHz)</b>	700/850/900	1700/1800/1900/2100	2600
<b>Frequency (MHz)</b>	698-960	1710-2170	2500-2700
<b>Return Loss (dB)</b>	~-11.5	~-14.4	~-11.5
<b>VSWR</b>	~2.0:1	~1.5:1	~1.8:1
<b>Efficiency (%)</b>	~53	~52	~41
<b>Peak Gain (dBi)</b>	~2	~4.1	~4.1
<b>Average Gain (dB)</b>	~-2.8	~-2.8	~-3.9
<b>Impedance (Ohm)</b>	50		
<b>Polarisation</b>	Linear		
<b>Radiation Pattern</b>	Omni-Directional		
<b>Max. Input Power (W)</b>	25		
<b>Connector Type</b>	Most RF Connectors (SMA-Male Standard)		
<b>Cable Length</b>	Any Cable Length (300cm Standard)		
<b>Cable Type</b>	Other Cables Available (LMR100 Standard)		

### Antenna Measurement Conditions:

Mounted on 30 x 30 x 0.25 cm ABS Plate

200 cm LMR100 Cable

Measured in Certified CTIA 3D Anechoic Chamber

## 2. Mechanical and environmental specifications

Specifications	2J5124P
<b>Mounting Type</b>	Adhesive Mount
<b>Dimensions (mm)</b>	122 x 14 x 6
<b>Radome</b>	TPE
<b>Radome color</b>	Black, White
<b>Operating Temperature (C)</b>	-40 to +85
<b>Storage Temperature (C)</b>	-40 to +85
<b>Substance Compliance</b>	RoHS

### 3. Antenna parameters

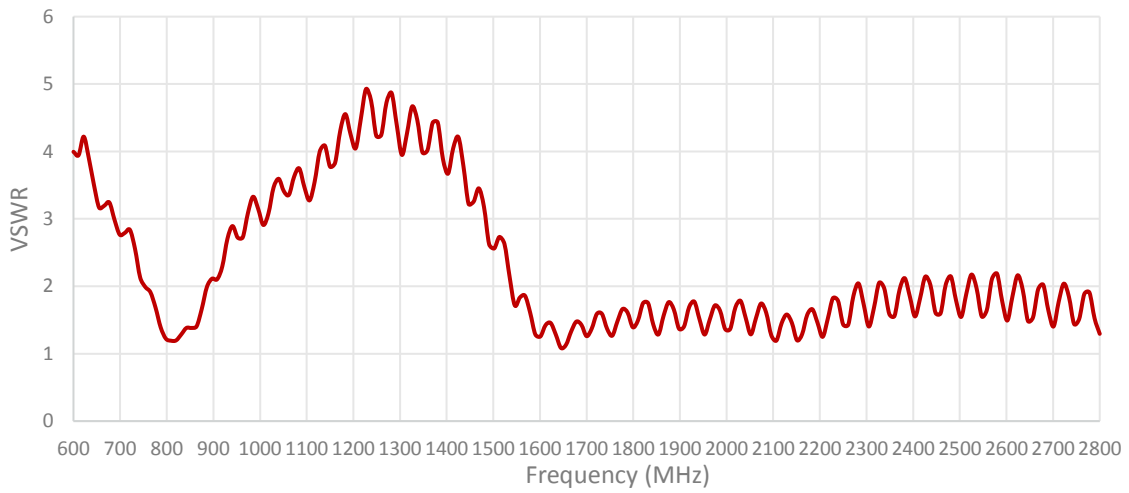
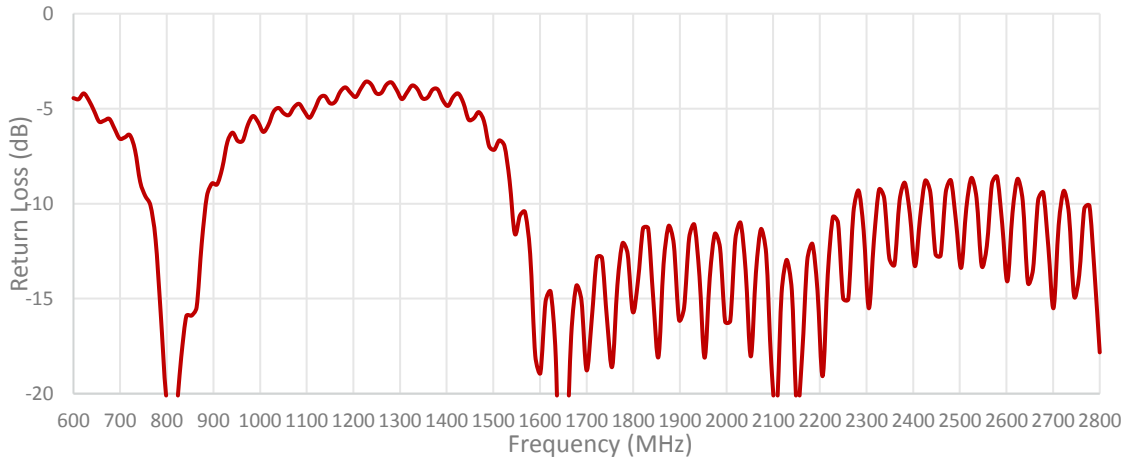

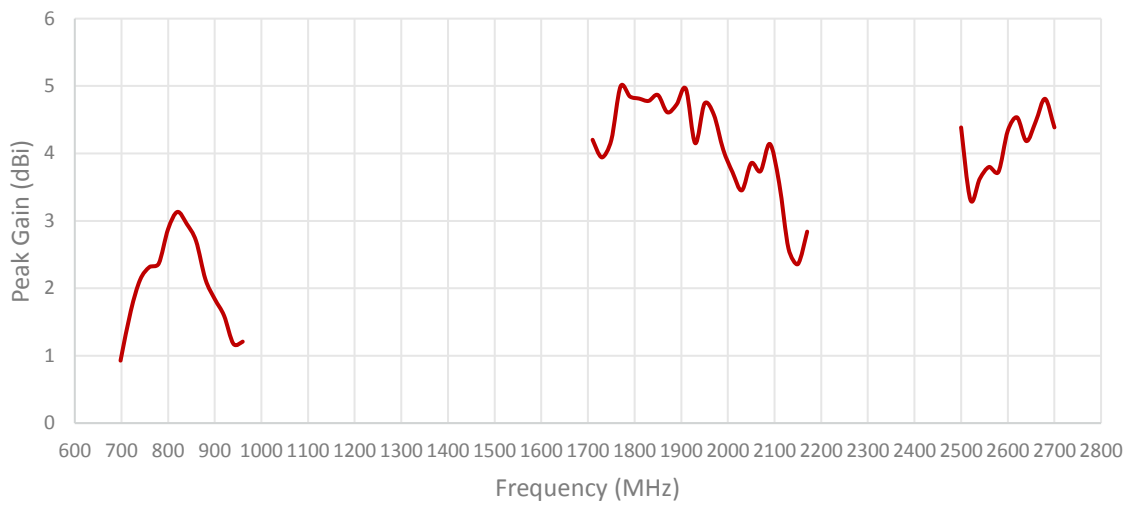
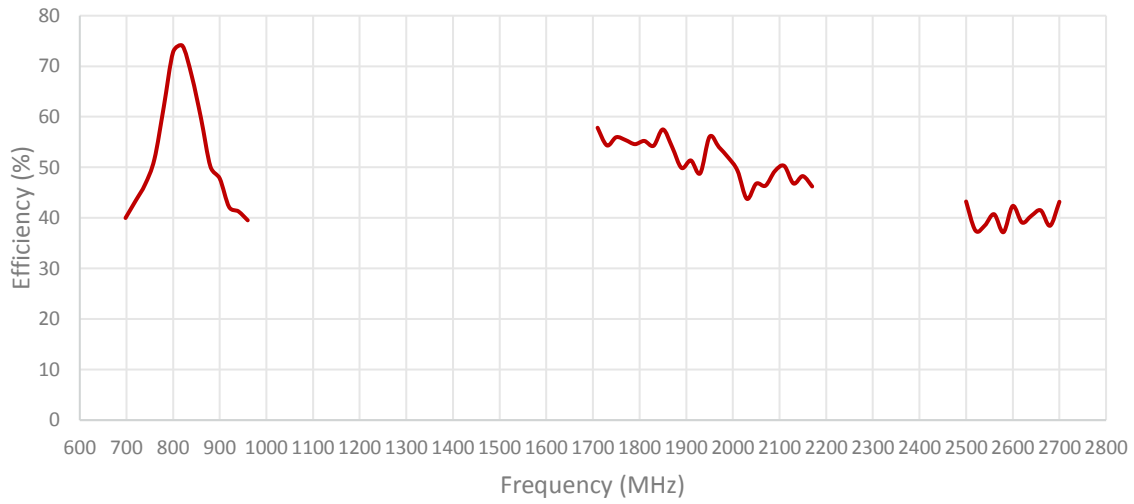

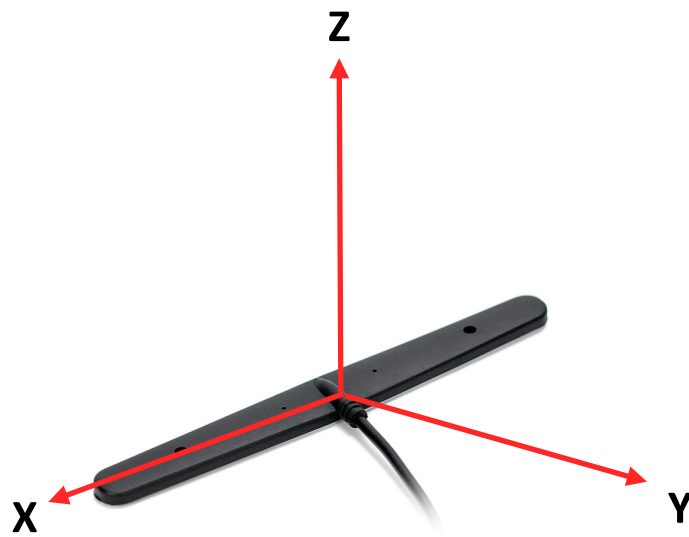
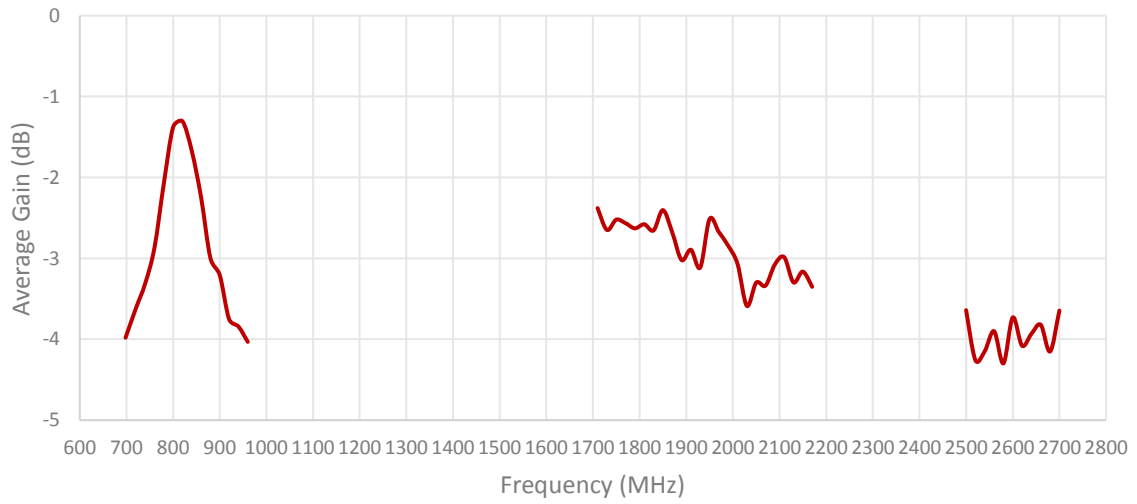

Radiation pattern reference

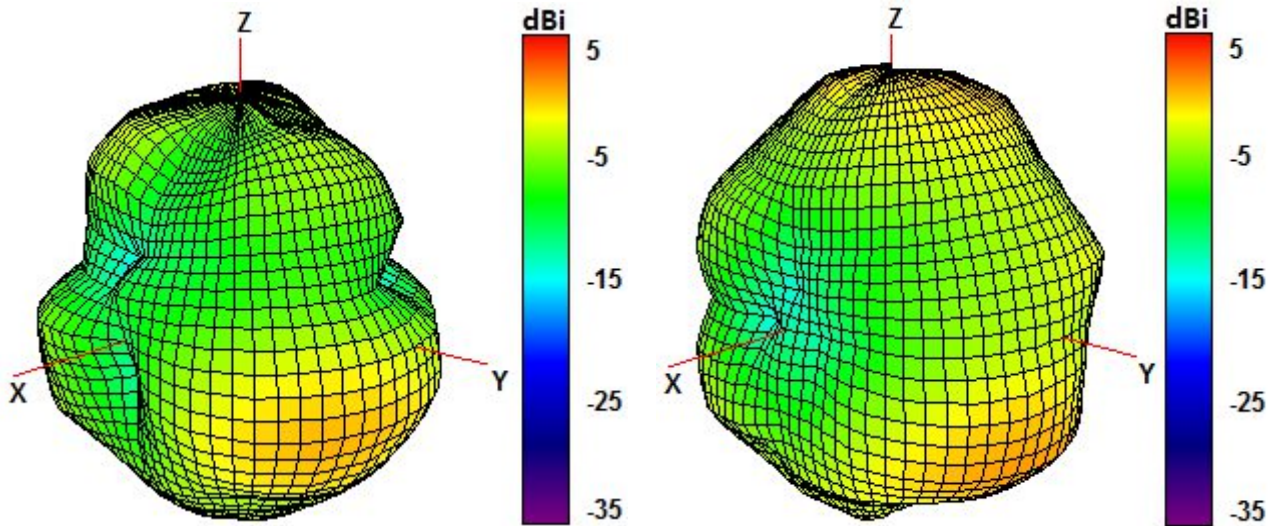

750 and 850 MHz Radiation pattern

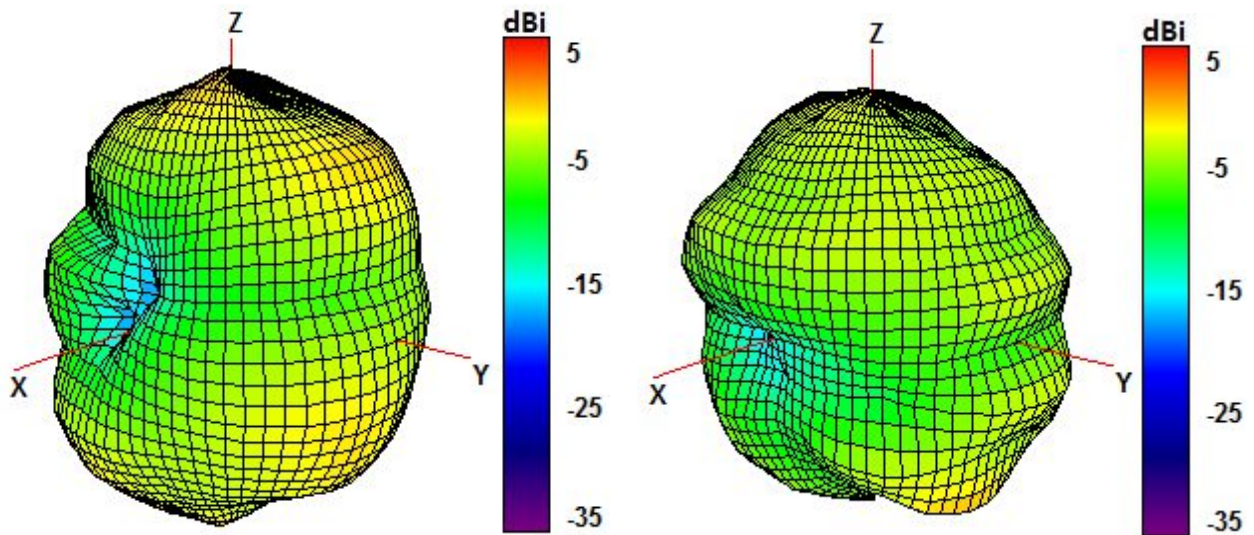

940 and 1750 MHz Radiation pattern

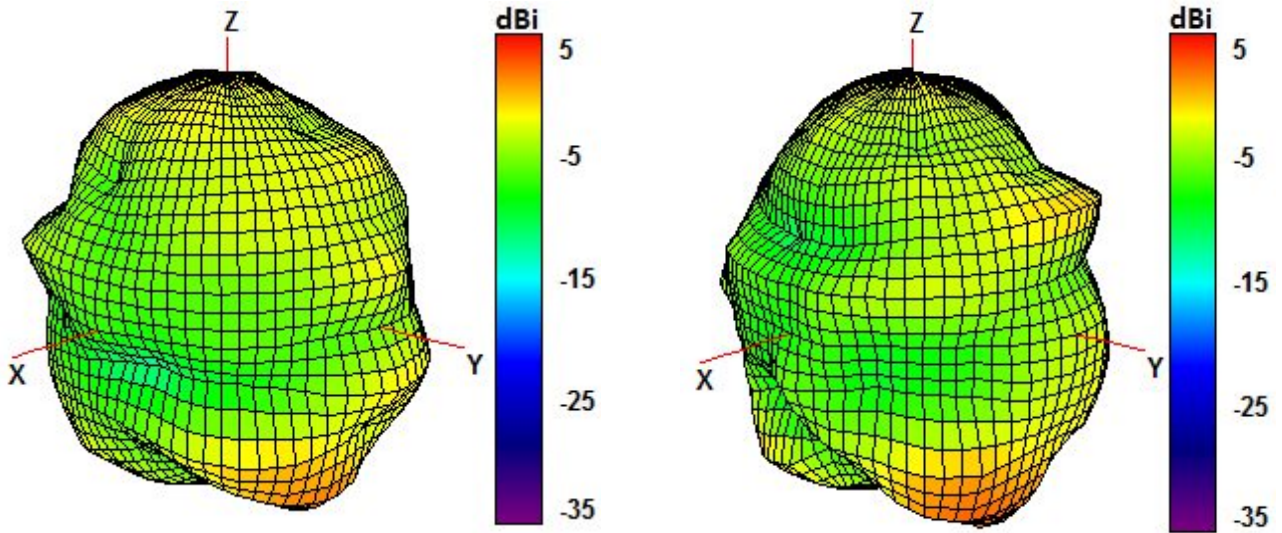

1850 and 1950 MHz Radiation pattern

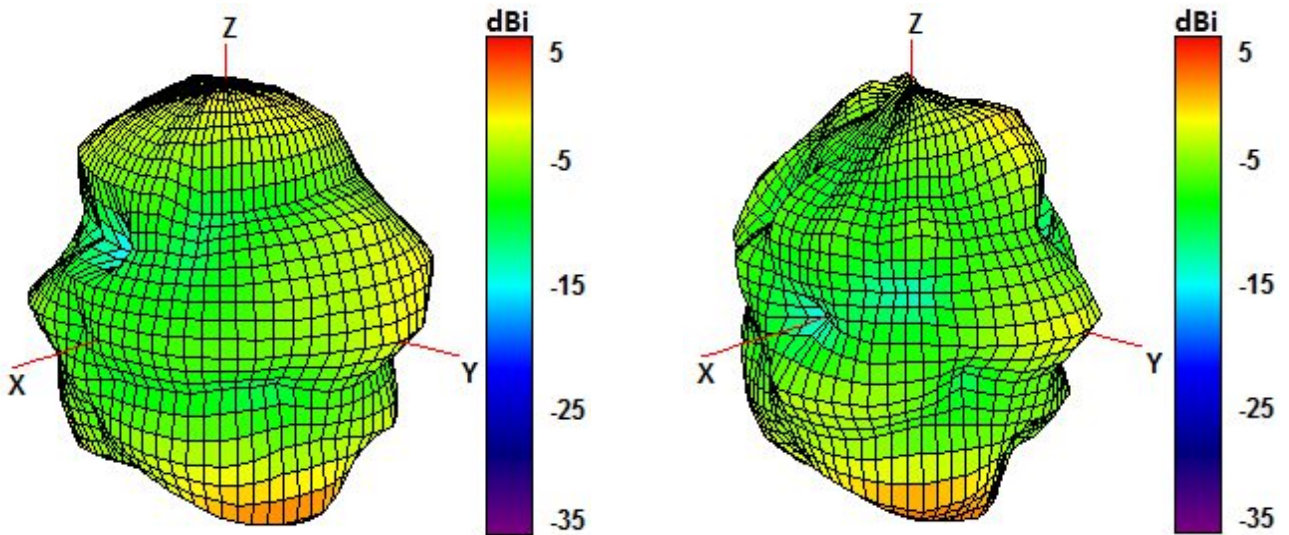

2100 and 2600 MHz Radiation pattern

## 4. Antenna drawings

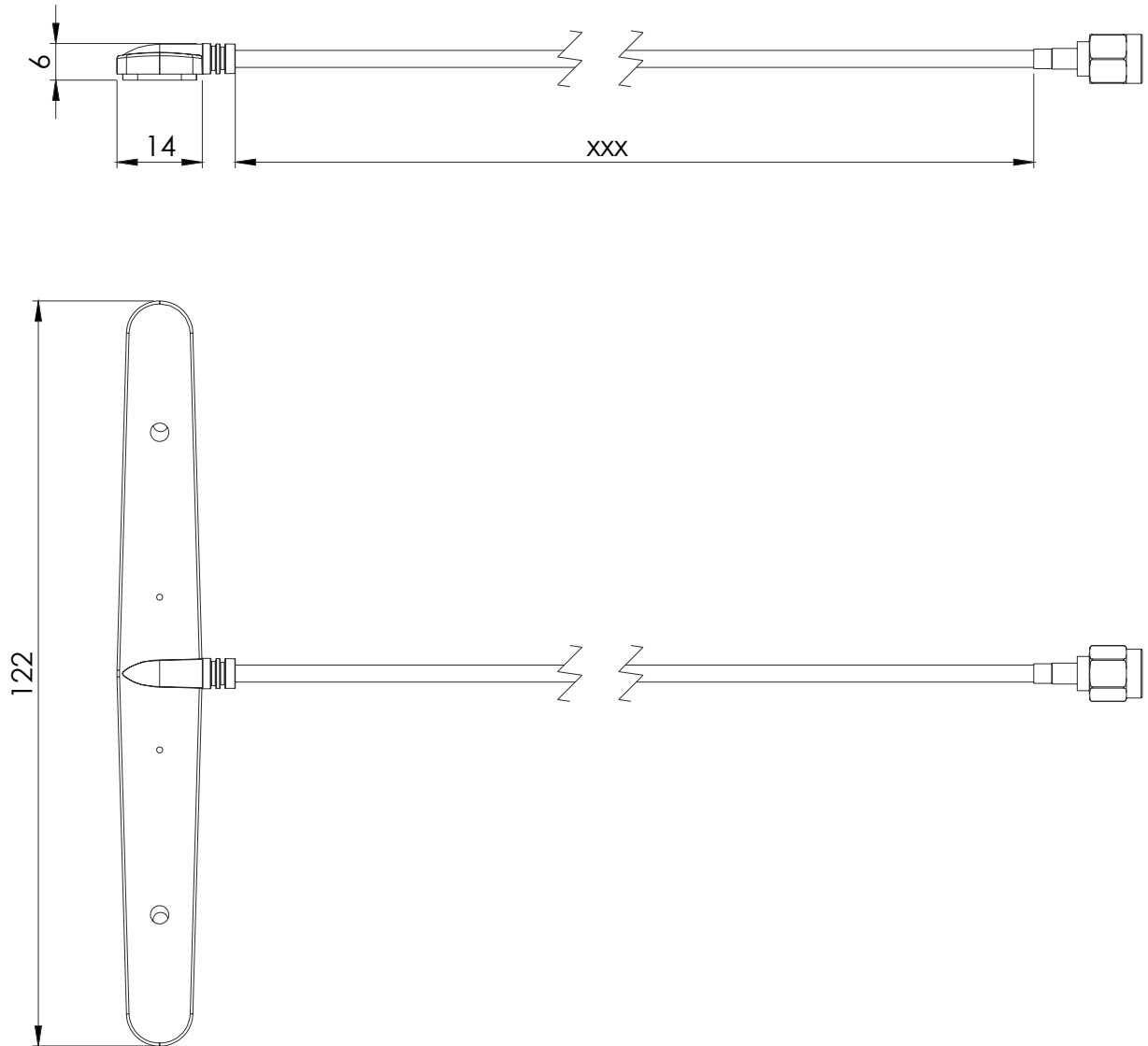



## 5. Antenna Images



## X-ON Electronics

Largest Supplier of Electrical and Electronic Components

*Click to view similar products for [Antennas](#) category:*

*Click to view products by [2J](#) manufacturer:*

Other Similar products are found below :

[930-033-R](#) [EXE902SM](#) [APAMPG-117](#) [66089-2406](#) [A09-F8NF-M](#) [A09-F5NF-M](#) [RGFRA1903041A1T](#) [108-00016-050](#) [W3525BW100](#)  
[SIMNA-868](#) [SIMNA-915](#) [SIMNA-433](#) [W1049B090](#) [TRABT1560](#) [WTL2449CQ1-FRSMM](#) [CPL9C](#) [0600-00060](#) [Y4503](#) [PAL90209H-FNF](#)  
[GD53-25](#) [C37](#) [MAF94051](#) [S9025PLSMF](#) [EXD420PL](#) [QWFTB120](#) [MAF94300](#) [FG4403](#) [MIKROE-2393](#) [GPSCPMM00](#) [ANTDOM-05-01-](#)  
[WPM](#) [ANT-WP868SMA-Y](#) [EXW30BNX](#) [RAD-ISM-2459-ANT-FOOD-6-0-](#) [S4908WBFNM](#) [GD57-21](#) [108-20131-010](#) [108-00032-010](#)  
[C27S](#) [CBNC58](#) [EXH160MXI](#) [EXH160SFK](#) [MD10-004](#) [EXC902SM](#) [CB27](#) [ABFT](#) [BB4502NR](#) [B4502N](#) [S4908WBFNF](#) [ANT-](#)  
[GSMGPSPUKS](#) [60210](#)