

2J7624B

CELLULAR/LTE Screw Mount

Key Features

Cable 1: CELLULAR / LTE

- 698-960 MHz
- 1710-2170 MHz
- 2500-2700 MHz

Screw Mount

Anti-Rotation Mechanism

Ground Plane Independent

Customizable Cable and Connector

Dimensions: Ø 50 x 50.8 mm

Certificates: IP67, IP69



1. Antenna and electrical specifications

Cable 1

Parameters	CELLULAR / LTE Antenna		
Standards	2G,3G and 4G		
Band (MHz)	700/850/900	1700/1800/1900/2100	2600
Frequency (MHz)	698-960	1710-2170	2500-2700
Return Loss (dB)	~-10.1	~-11.5	~-7.5
VSWR	~2.1:1	~1.8:1	~2.5:1
Efficiency (%)	~56.4	~56.1	~37.8
Peak Gain (dBi)	~2.6	~3.2	~1.4
Average Gain (dB)	~-2.5	~-2.5	~-4.2
Impedance (Ohm)	50		
Polarisation	Linear		
Radiation Pattern	Omni-Directional		
Max. Input Power (W)	25		
Connector Type	SMA-Male Standard (Other Connectors Available)		
Cable Length	300 cm Standard (Any Cable Length Available)		
Cable Type	DACAR100 Standard (Other Cables Available)		

Antenna Measurement Conditions:

Mounted on 30 x 30 cm Ground Plane
 DACAR100 200 cm Cable Length
 Measured in Certified CTIA 3D Anechoic Chamber

2. Mechanical and environmental specifications

Specifications	2J7624B
Mounting Type	Screw Mount
Dimensions (mm)	Ø 50 x 50.8
Max. Tighten Torque (Nm)	3 Nm
Radome Type	ASA
Radome Color	Black
Antenna Base	Zamak
Gasket	Double Sided Foam
Operating Temperature (C)	-40 to +85
Storage Temperature (C)	-40 to +85
Substance Compliance	RoHS
Certificates	IP67, IP69

3. Antenna parameters

Table 1: CELLULAR/LTE

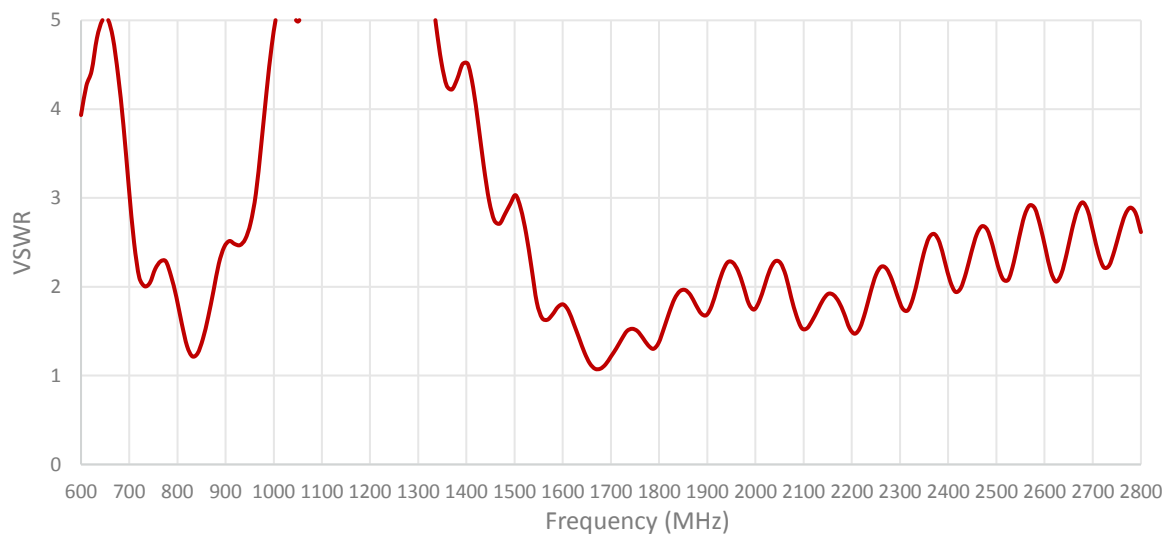
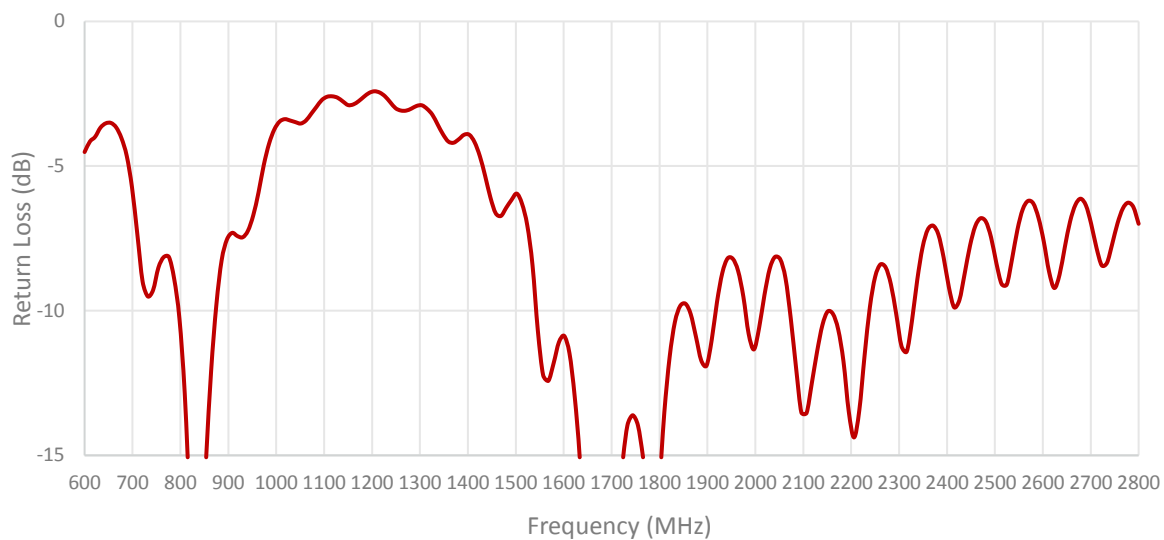

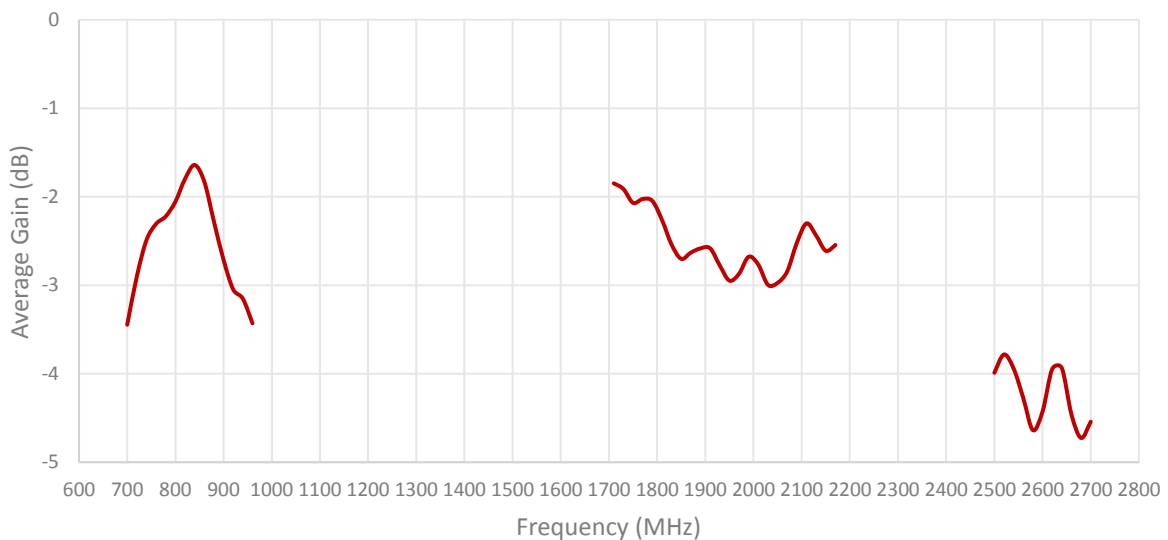
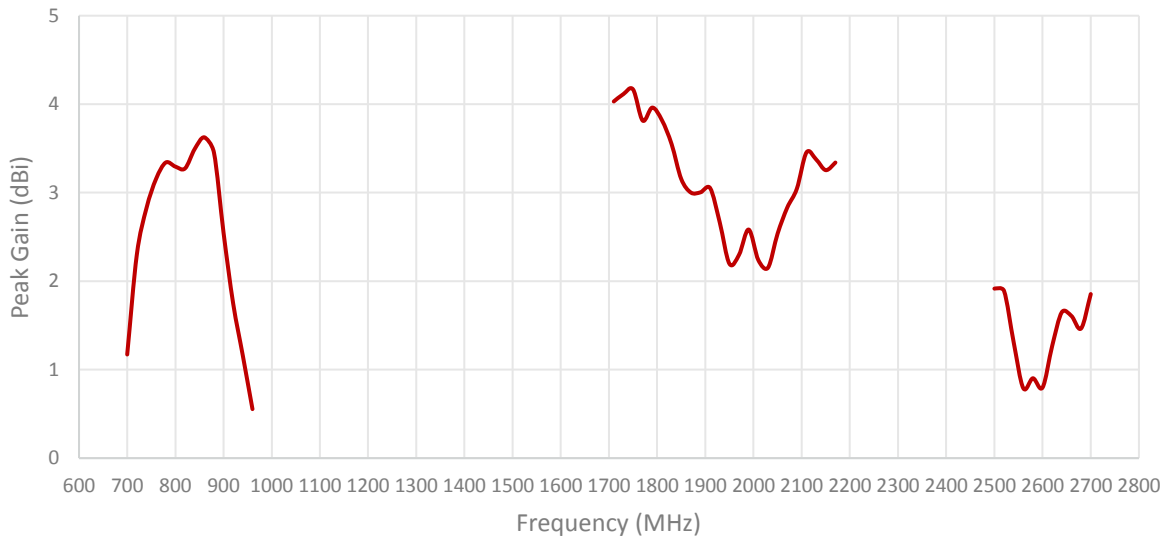
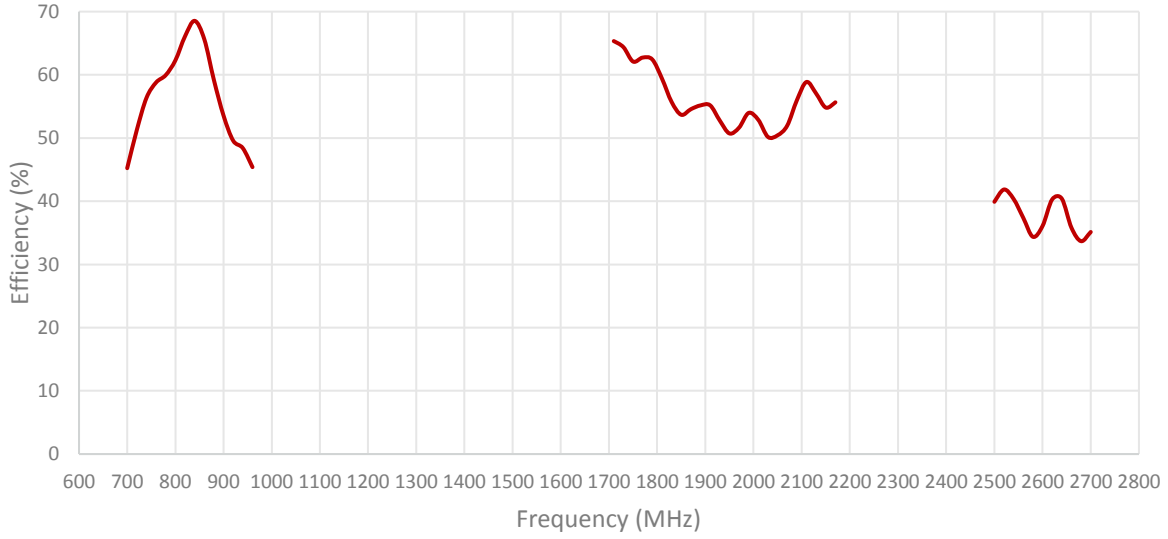

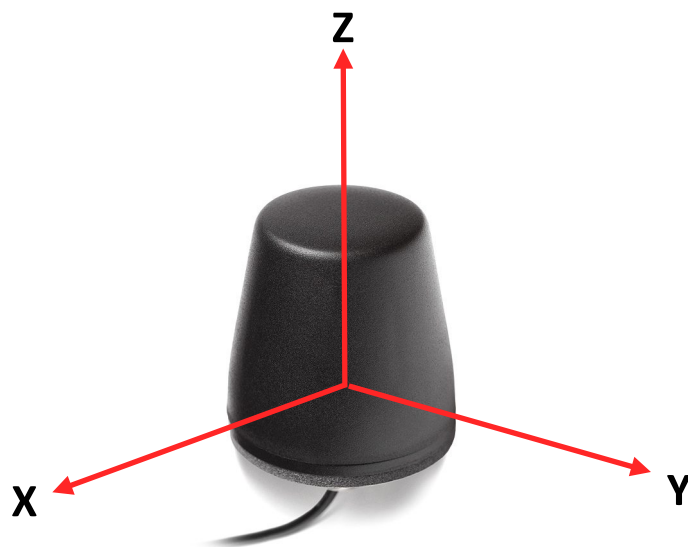

Radiation pattern reference

Cable 1: CELLULAR/LTE

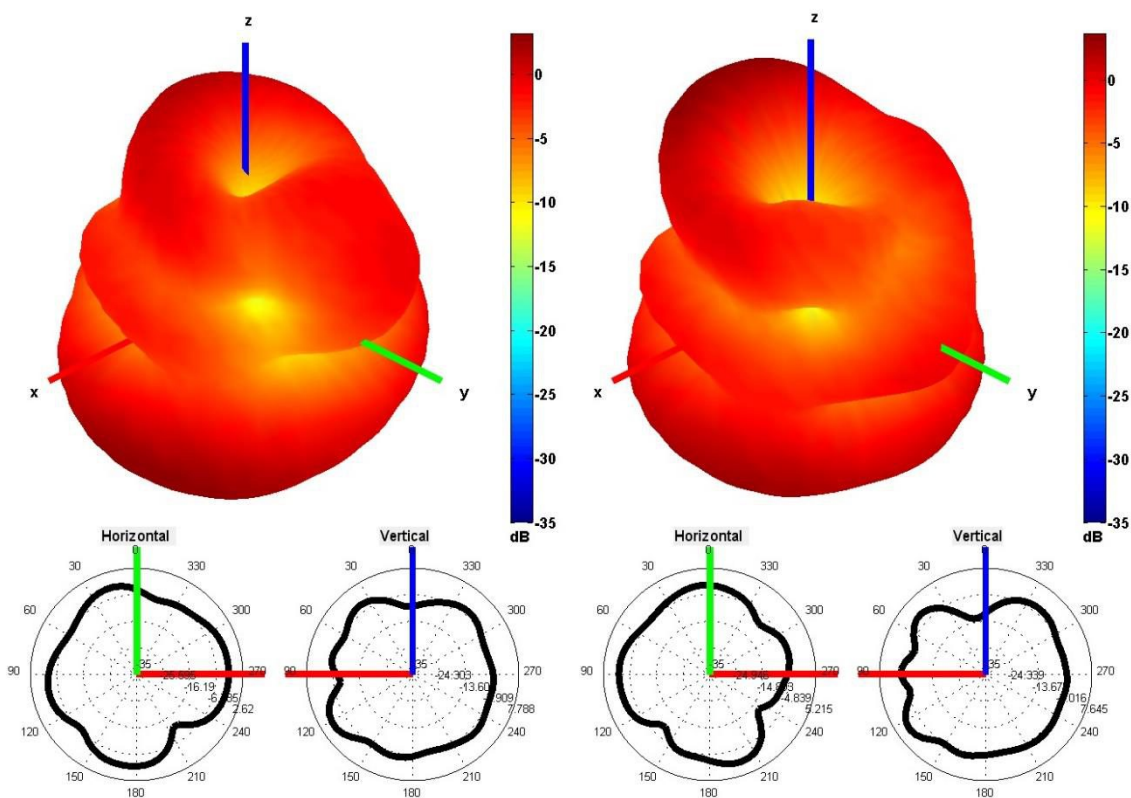

750 and 850 MHz Radiation pattern

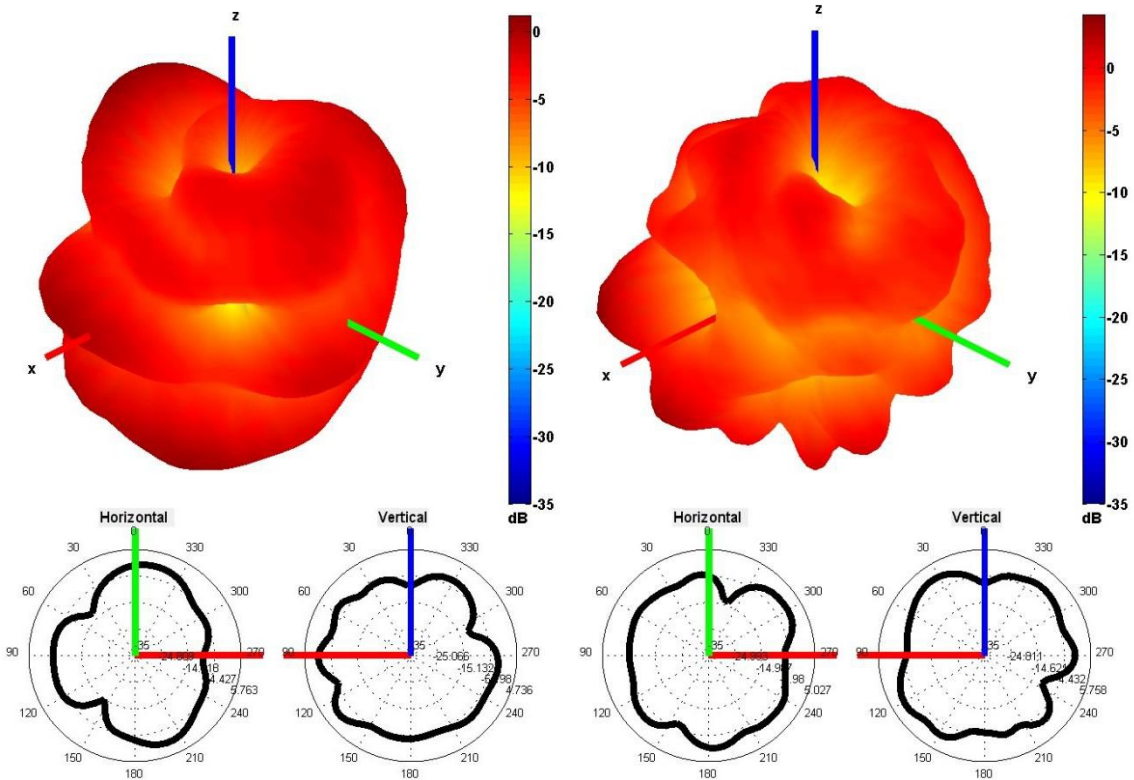

940 and 1750 MHz Radiation pattern

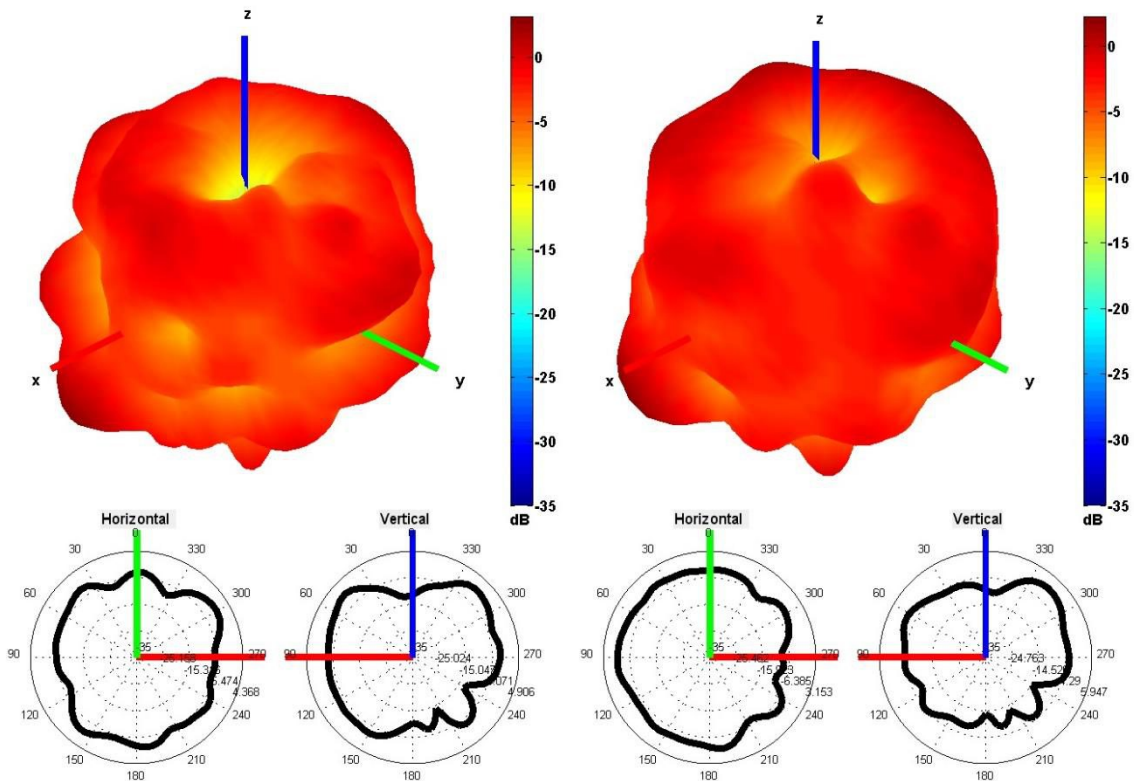

1850 and 1950 MHz Radiation pattern

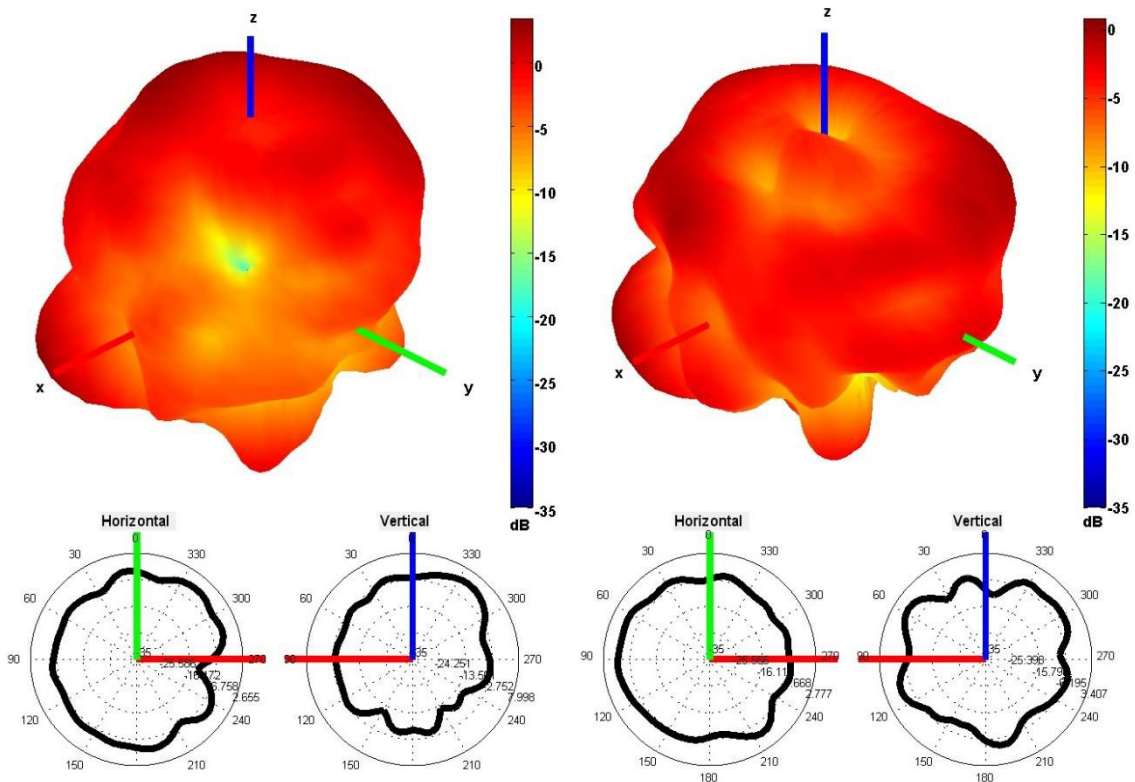

2100 and 2600 MHz Radiation pattern

4. Antenna drawings

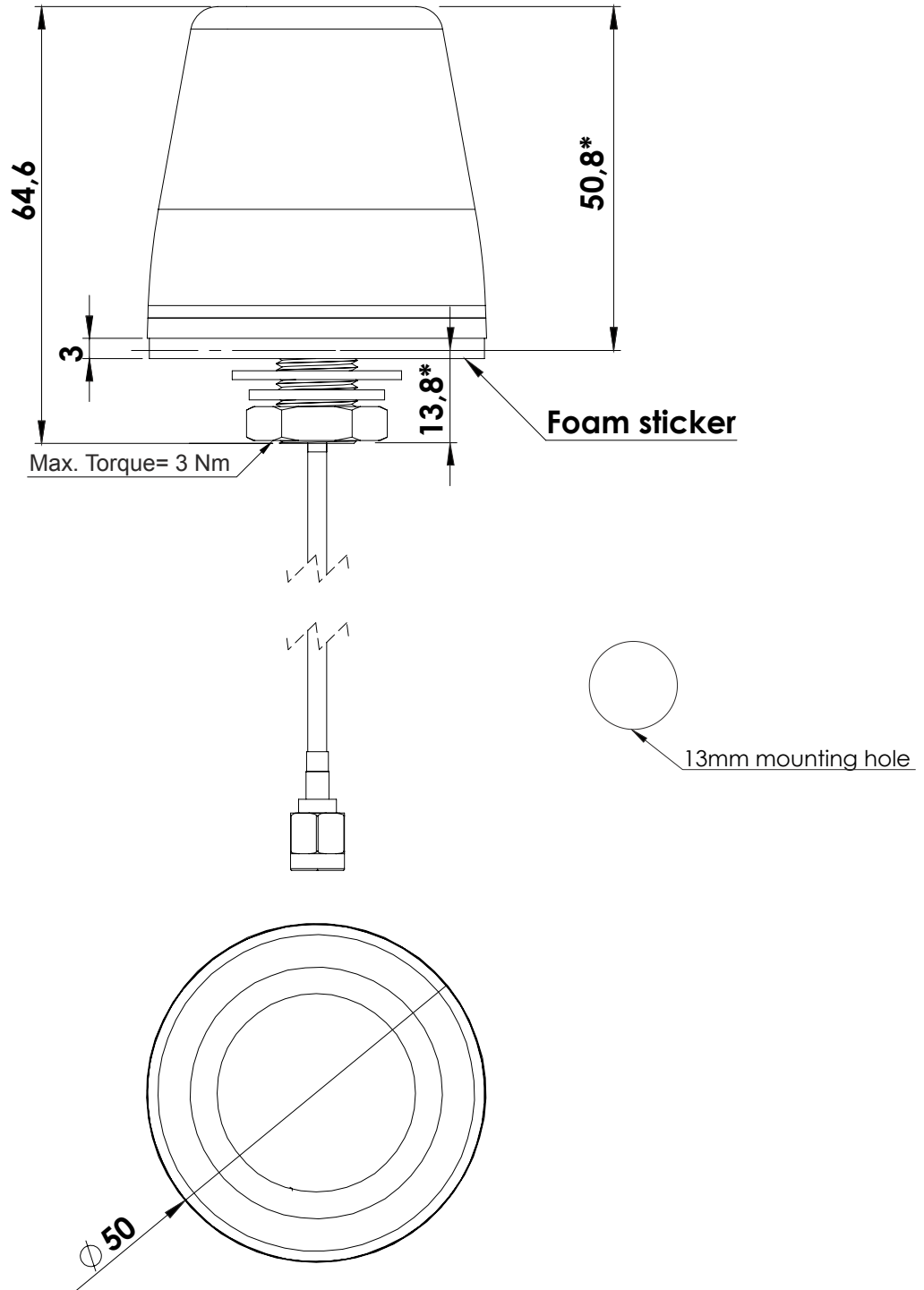

Note: Dimensions are in millimeters
*Dimensions are after mounting
**Max. Torque= 3 Nm

5. Antenna Images



X-ON Electronics

Largest Supplier of Electrical and Electronic Components

Click to view similar products for [Antennas](#) category:

Click to view products by [2J](#) manufacturer:

Other Similar products are found below :

[930-033-R](#) [EXE902SM](#) [APAMPG-117](#) [66089-2406](#) [A09-F8NF-M](#) [A09-F5NF-M](#) [RGFRA1903041A1T](#) [108-00016-050](#) [W3525BW100](#)
[SIMNA-868](#) [SIMNA-915](#) [SIMNA-433](#) [W1049B090](#) [TRABT1560](#) [WTL2449CQ1-FRSMM](#) [CPL9C](#) [0600-00060](#) [Y4503](#) [PAL90209H-FNF](#)
[GD53-25](#) [C37](#) [MAF94051](#) [S9025PLSMF](#) [EXD420PL](#) [QWFTB120](#) [MAF94300](#) [FG4403](#) [MIKROE-2393](#) [GPSCPMM00](#) [ANTDOM-05-01-](#)
[WPM](#) [ANT-WP868SMA-Y](#) [EXW30BNX](#) [RAD-ISM-2459-ANT-FOOD-6-0-](#) [S4908WBFNM](#) [GD57-21](#) [108-20131-010](#) [108-00032-010](#)
[C27S](#) [CBNC58](#) [EXH160MXI](#) [EXH160SFK](#) [MD10-004](#) [EXC902SM](#) [CB27](#) [ABFT](#) [BB4502NR](#) [B4502N](#) [S4908WBFNF](#) [ANT-](#)
[GSMGPSPUKS](#) [60210](#)