

2J7683B

5GNR Screw Mount

Key Features

Cable 1: 5GNR

- 617-960 MHz
- 1427-2690 MHz
- 3300-5000 MHz
- 5150-5925 MHz

Screw Mount

Ground Plane Independent

Customizable Cable and Connector

Dimensions: Ø 50 x 50.8 mm

Certificates: IP67, IP69



1. Antenna and electrical specifications

| Parameters | 5GNR Antenna | | | |
|-----------------------------|---|---|---------------------------------|----------------------|
| Technologies | 5G, 4G, 3G and 2G | | | |
| Standards | 5GNR/4GLTE/FirstNet/CBRS/LPWA/CAT-X/CAT-Mx/CAT-NBx/NB-IoT/3G/2G | | | |
| Frequency (MHz) | 617-960 | 1427-2690 | 3300-5000 | 5150-5925 |
| Band (MHz) | 600, 700, 850, 900 | 1500, 1600, 1700, 1800, 1900, 2000, 2100, 2300, 2500, 2600 | 3300, 3500, 3600, 3700, 4500 | 5200, 5500, 5800 |
| 5GNR Bands | n5, n8, 12, n20, n28, n71, n81, n82, n83, | n1, n2, n3, n7, n25, n34, n38, n39, n40, n41, n50, n51, n66, n70, n74, n75, n76, n80, n84, n86 | n77, n78, n79 | |
| 4GLTE Bands | B5, B6, B8, B12, B13, B14, B17, B18, B19, B20, B26, B27, B28, B29, B44, B67, B68, B71, B85 | B1, B2, B3, B4, B7, B9, B10, B11, B21, B23, B24, B25, B30, B32, B33, B34, B35, B36, B37, B38, B39, B40, B41, B45, B50, B51, B65, B66, B69, B70, B74, B75, B76 | B22, B42, B43, B48, B49, B52 | B46, B47, B252, B255 |
| 3GCELL Bands | B5, B6, B8, B12, B13, B14, B19, B20, B26 | B1, B2, B3, B4, B7, B9, B10, B11, B21, B25, B32, B33, B34, B35, B36, B37, B38, B39, B40 | B22 | |
| 2GCELL Bands | 710, 750, 810T, 850, 900P, 900E, 900R | 1800DCS, 1900PCS | | |
| CDMACELL Bands | BC0, BC2, BC3, BC7, BC9, BC10, BC12, BC18, BC19 | BC1, BC4, BC6, BC8, BC13, BC14, BC15, BC16, BC20, BC21 | | |
| Return Loss (dB) | ~-9.7 | ~-10.0 | ~-10.8 | ~-14.7 |
| VSWR | ~2.3:1 | ~2.1:1 | ~2.0:1 | ~1.6:1 |
| Efficiency (%) | ~48.1 | ~45.9 | ~25.2 | ~22.5 |
| Peak Gain (dBi) | ~2.9 | ~2.1 | ~0.5 | ~-1.0 |
| Average Gain (dB) | ~-3.5 | ~-3.7 | ~-6.2 | ~-6.8 |
| Impedance (Ohm) | 50 | | | |
| Polarisation | Linear | | | |
| Radiation Pattern | Omni-Directional | | | |
| Max. Input Power (W) | 25 | | | |
| Connector Type | SMA-Male Standard (Other Connectors Available) | | | |
| Cable Length | 300 cm Standard (Any Cable Length Available) | | | |
| Cable Type | LL100 Standard (Other Cables Available) | | | |

Antenna Measurement Conditions:

Mounted on 30 x 30 cm Ground Plane

100 cm of LL100 Cable

Measured in Certified CTIA 3D Anechoic Chamber

2. Mechanical and environmental specifications

| Specifications | 2J7683B |
|----------------------------------|-------------------|
| Mounting Type | Screw Mount |
| Dimensions (mm) | Ø 50 x 50.8 |
| Max. Tighten Torque (Nm) | 3 Nm |
| Radome Type | ASA |
| Radome Color | Black |
| Antenna Base | Zamak |
| Gasket | Double Sided Foam |
| Operating Temperature (C) | -40 to +85 |
| Storage Temperature (C) | -40 to +85 |
| Substance Compliance | RoHS |
| Certificates | IP67, IP69 |

3. Antenna parameters

Cable 1: 5GNR

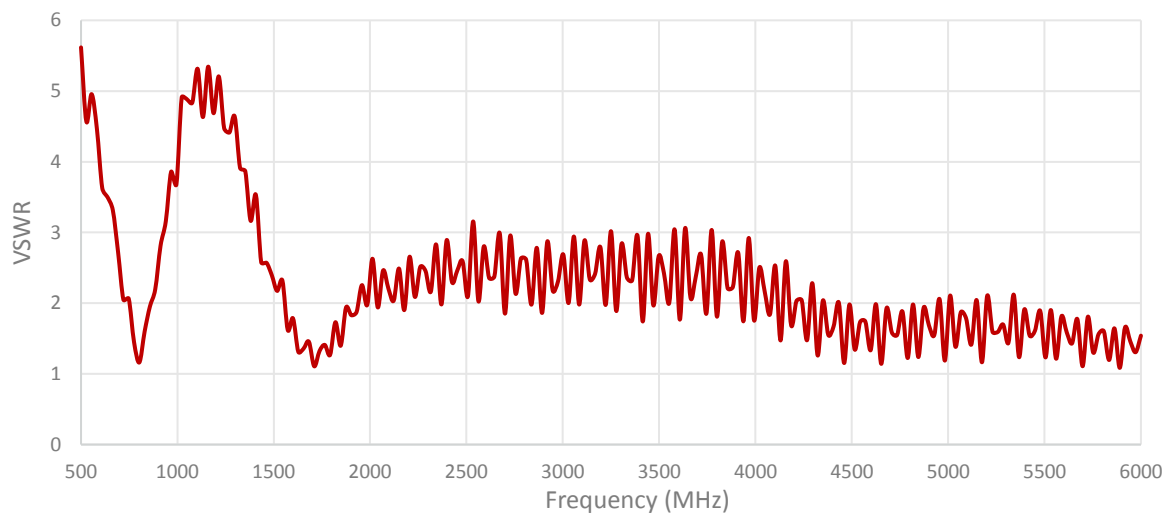
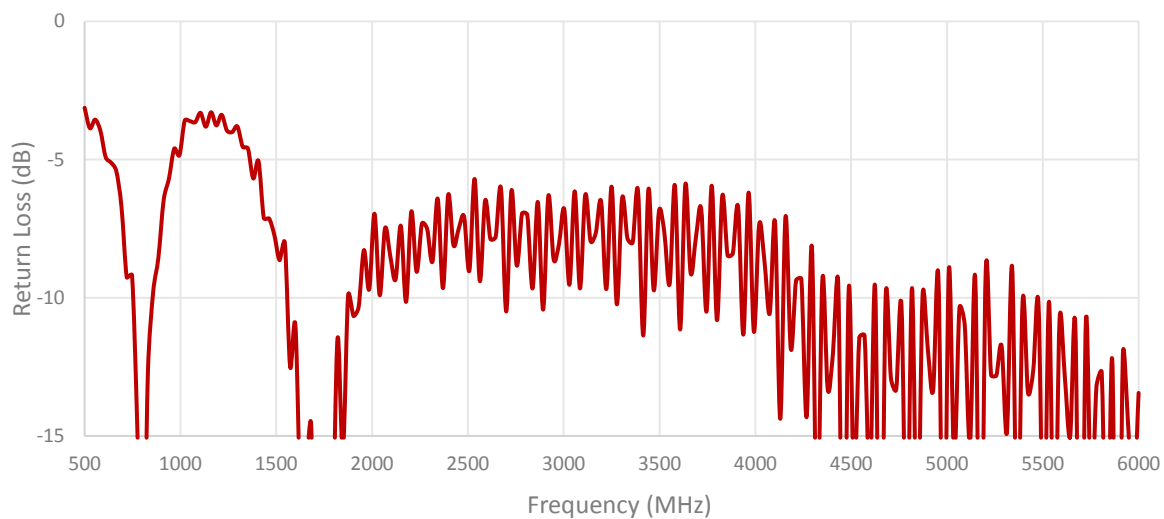

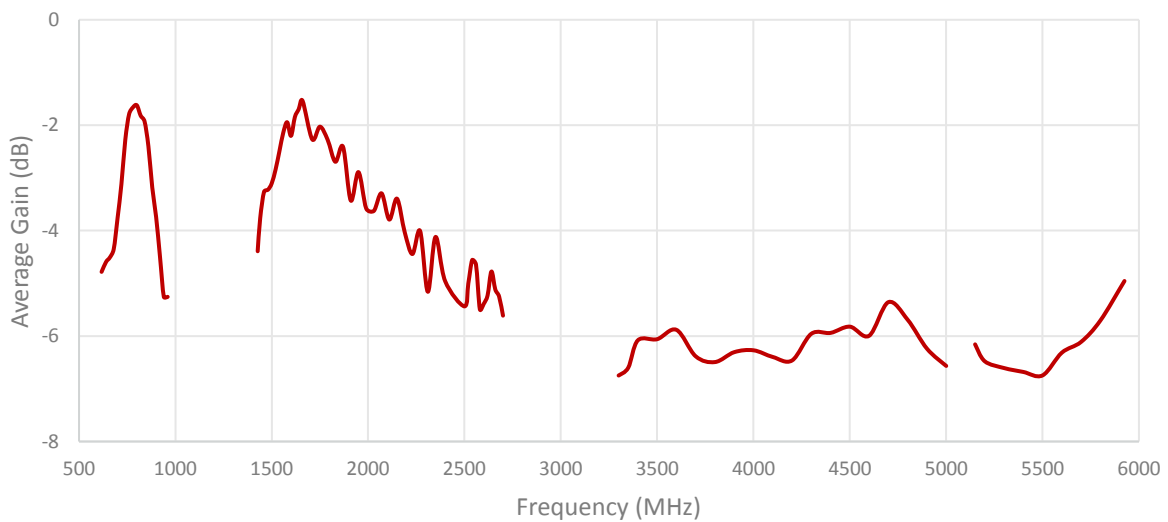
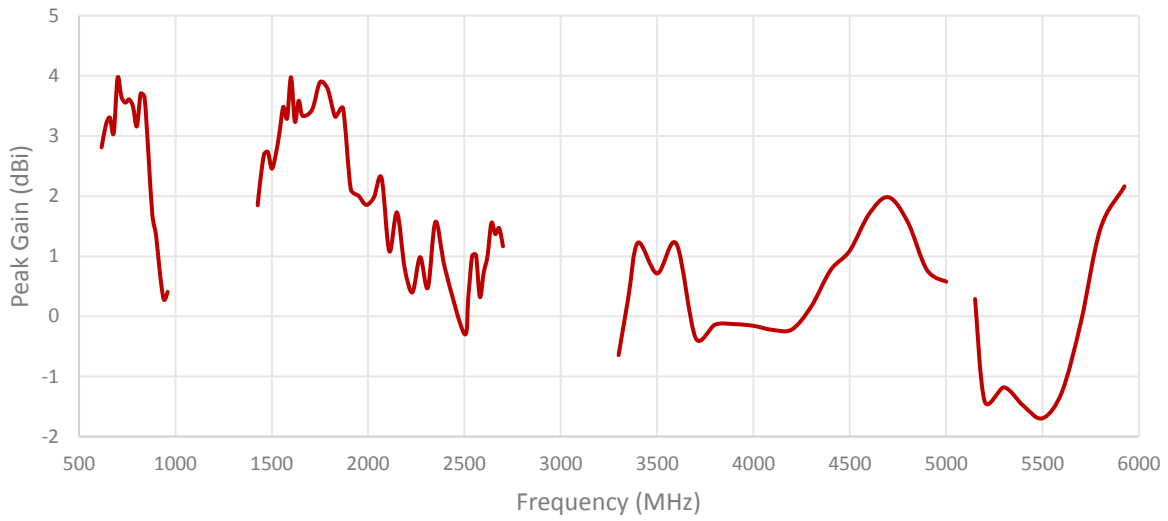
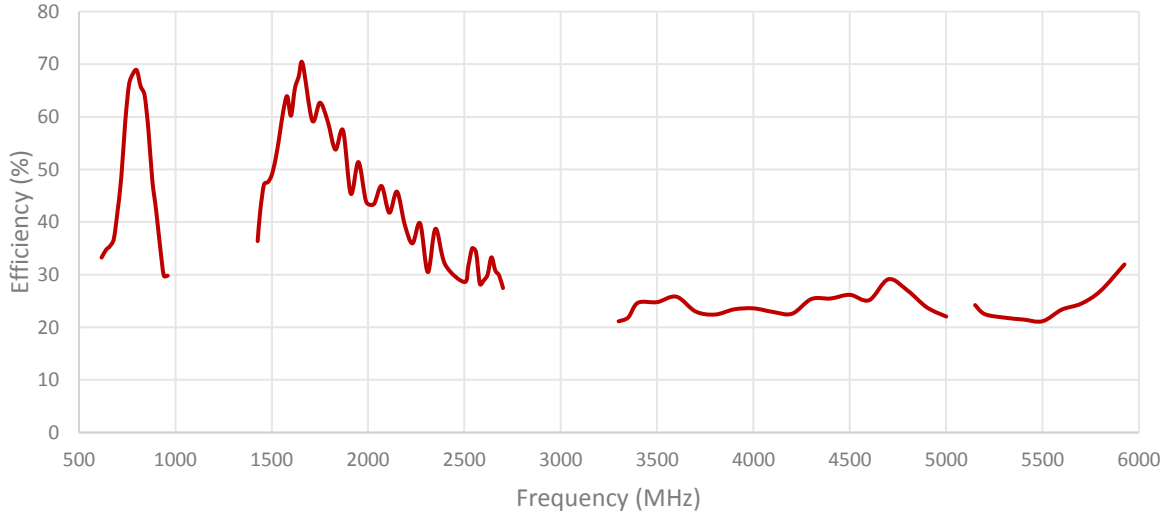

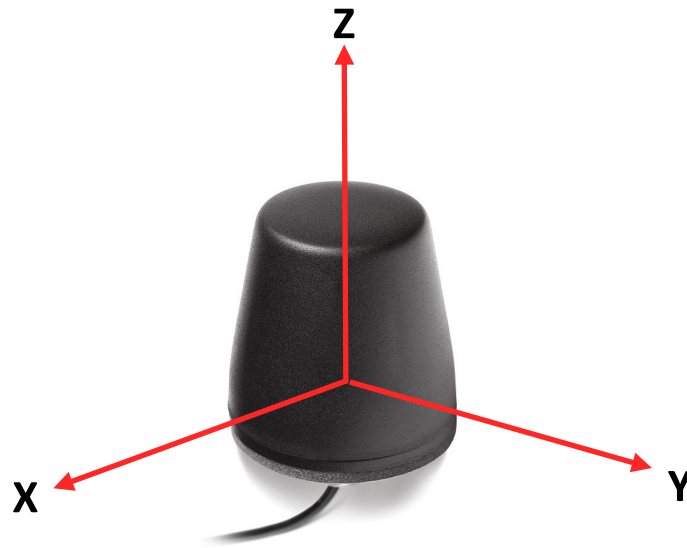

Radiation pattern reference

Cable 1: 5GNR

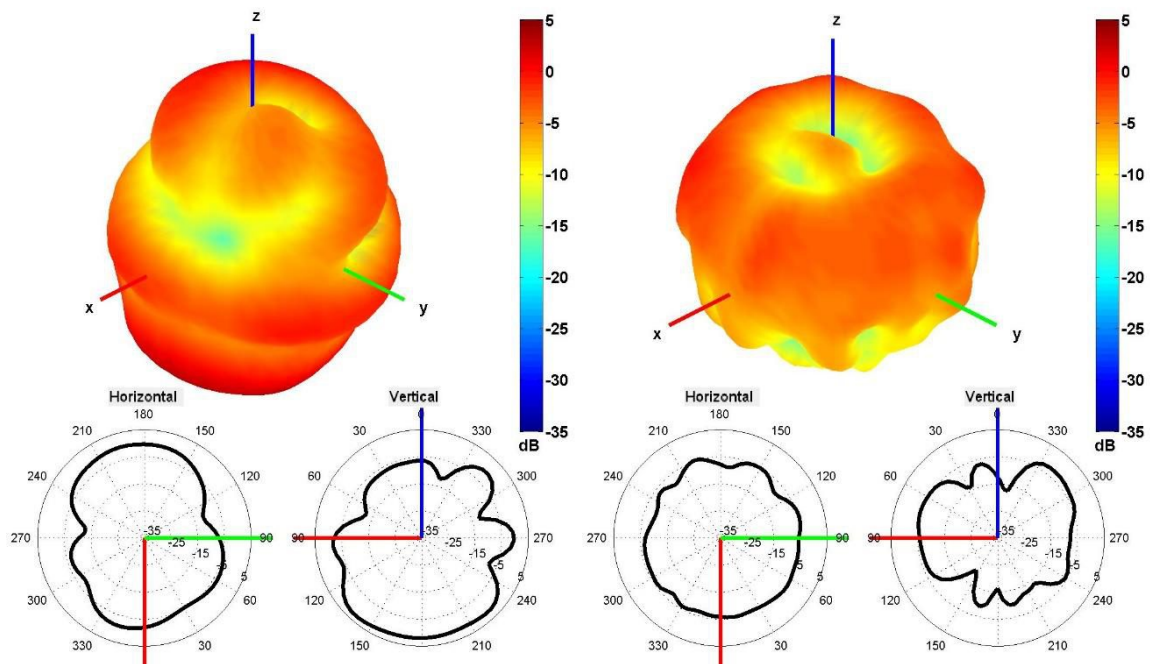

740 and 2500 MHz Radiation pattern

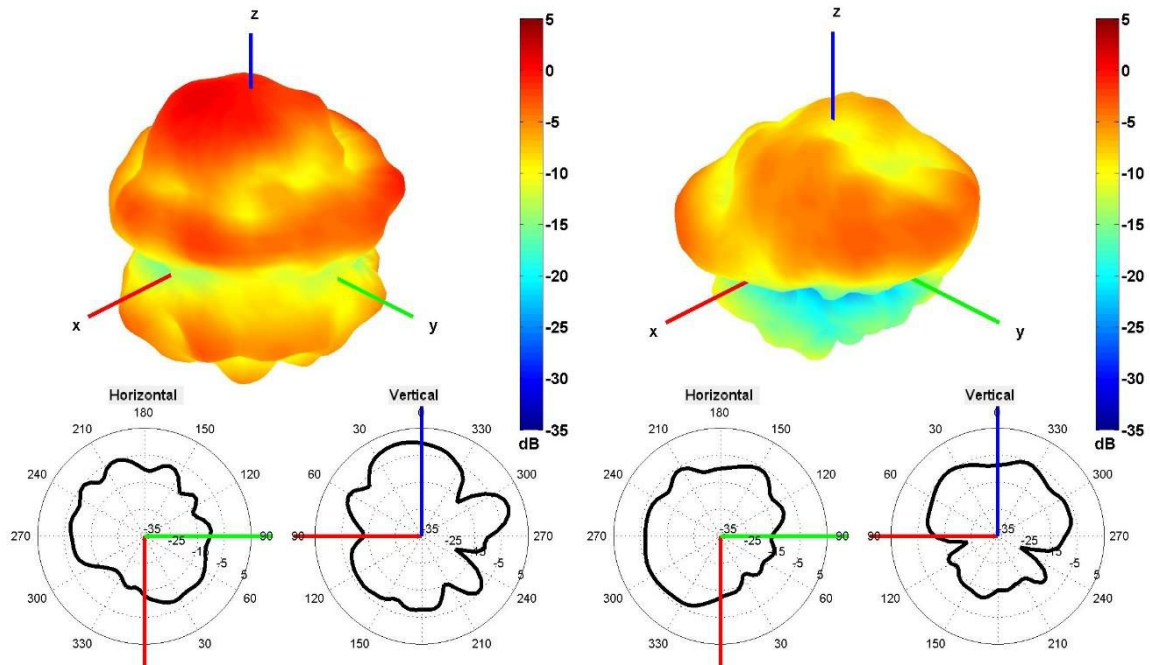

4500 and 5500 MHz Radiation pattern

4. Antenna drawings

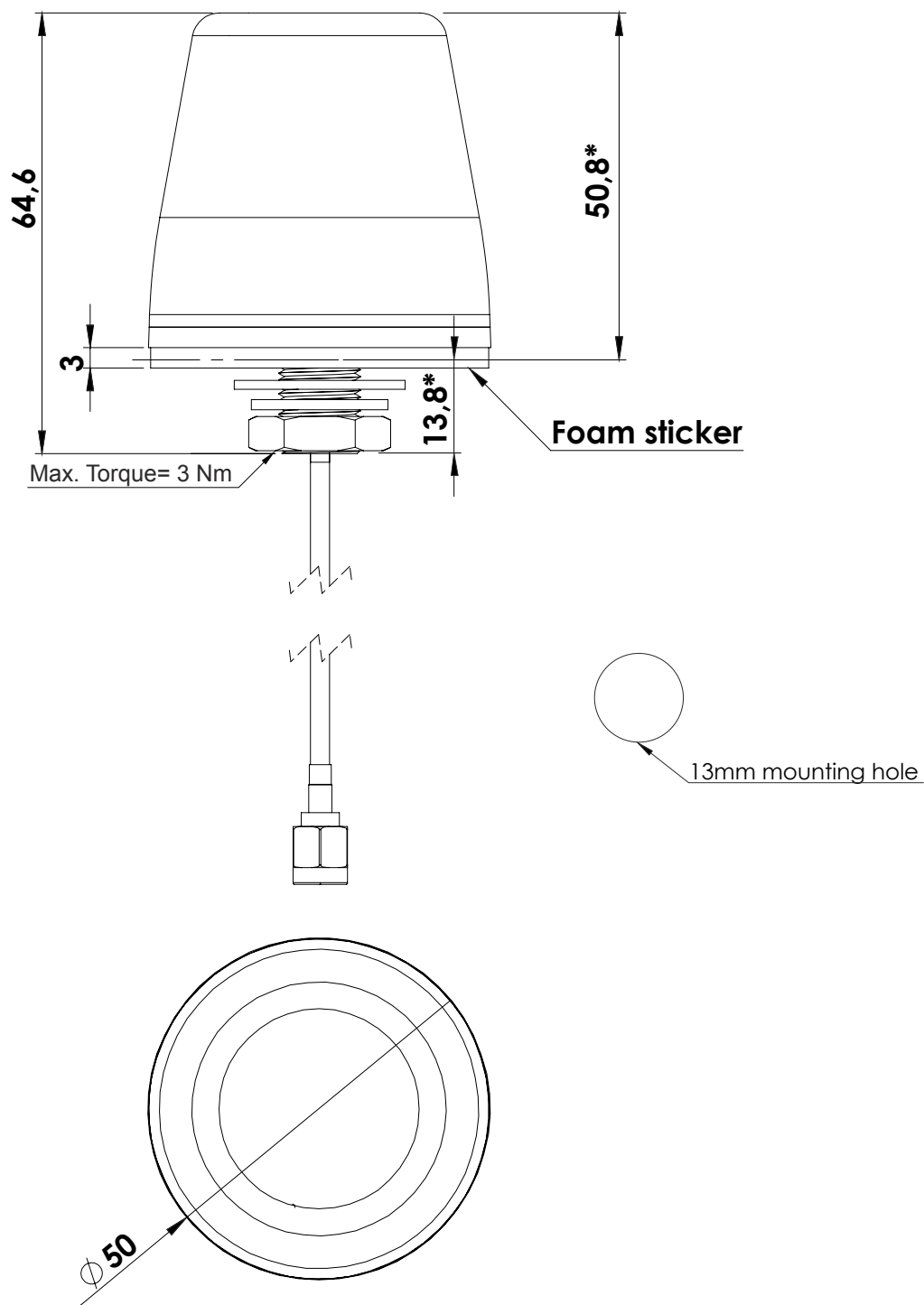

Note: Dimensions are in millimeters
*Dimensions are after mounting
**Max. Torque= 3 Nm

5. Antenna Images



X-ON Electronics

Largest Supplier of Electrical and Electronic Components

Click to view similar products for [Antennas](#) category:

Click to view products by [2J](#) manufacturer:

Other Similar products are found below :

[930-033-R](#) [EXE902SM](#) [APAMPG-117](#) [66089-2406](#) [A09-F8NF-M](#) [A09-F5NF-M](#) [RGFRA1903041A1T](#) [108-00016-050](#) [W3525BW100](#)
[SIMNA-868](#) [SIMNA-915](#) [SIMNA-433](#) [W1049B090](#) [TRABT1560](#) [WTL2449CQ1-FRSMM](#) [CPL9C](#) [0600-00060](#) [Y4503](#) [PAL90209H-FNF](#)
[GD53-25](#) [C37](#) [MAF94051](#) [S9025PLSMF](#) [EXD420PL](#) [QWFTB120](#) [MAF94300](#) [FG4403](#) [MIKROE-2393](#) [GPSCPMM00](#) [ANTDOM-05-01-](#)
[WPM](#) [ANT-WP868SMA-Y](#) [EXW30BNX](#) [RAD-ISM-2459-ANT-FOOD-6-0-](#) [S4908WBFNM](#) [GD57-21](#) [108-20131-010](#) [108-00032-010](#)
[C27S](#) [CBNC58](#) [EXH160MXI](#) [EXH160SFK](#) [MD10-004](#) [EXC902SM](#) [CB27](#) [ABFT](#) [BB4502NR](#) [B4502N](#) [S4908WBFNF](#) [ANT-](#)
[GSMGPSPUKS](#) [60210](#)