

2JW0302-2.4-C442B

2.4 GHz ISM Connector Mount

Key Features

2.4 GHz ISM

- 2410-2490 MHZ

Connector Mount

Ground Plane Independent

Hinged Connector

High Efficiency

Dimensions 113 x 10 mm



1. Antenna and electrical specifications

Parameters	2.4 GHz ISM Antenna
Standards	WiFi, BT, ZigBee, ISM
Band (MHz)	2.4 Ghz
Frequency (MHz)	2410-2490
Return Loss (dB)	~-10
VSWR	~1.9:1
Efficiency (%)	~62
Peak Gain (dBi)	~1.5
Average Gain (dB)	~-2.0
Impedance (Ohm)	50
Polarisation	Vertical
Radiation Pattern	Omni-Directional
Max. Input Power (W)	25
Connector Type	SMA-Male RP Standard

Antenna Measurement Conditions:

Free Space

Measured in Certified CTIA 3D Anechoic Chamber

2. Mechanical and environmental specifications

Specifications	2JW0302-2.4-C442B
Mounting Type	Connector Mount
Dimensions (mm)	113 x 10
Radome	ABS UV Stable
Radome color	Black
Operating Temperature (C)	-40 to +85
Storage Temperature (C)	-40 to +85
Substance Compliance	RoHS

3. Antenna parameters

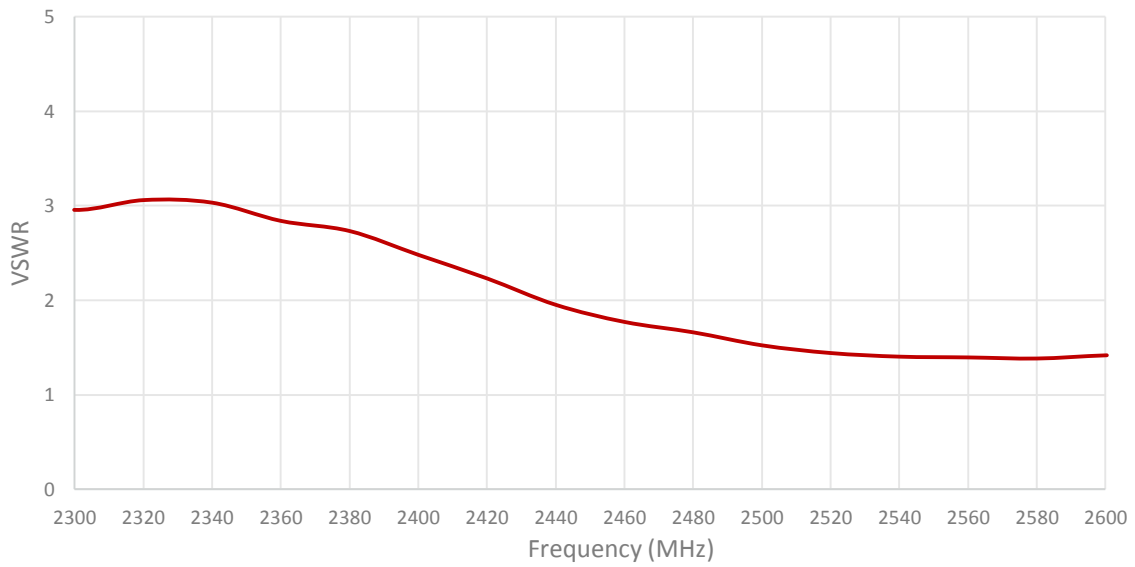
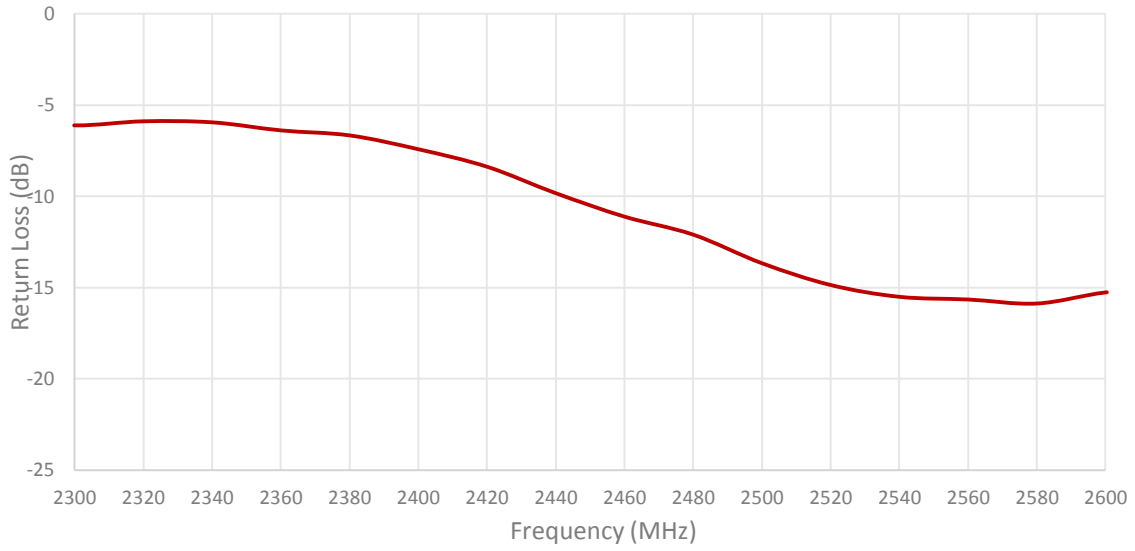

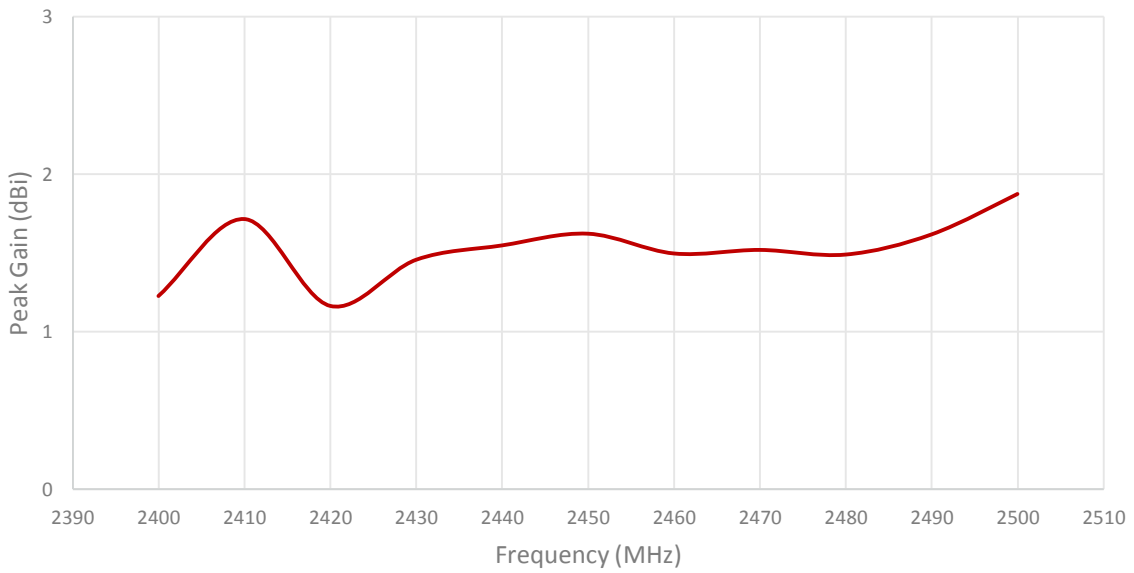
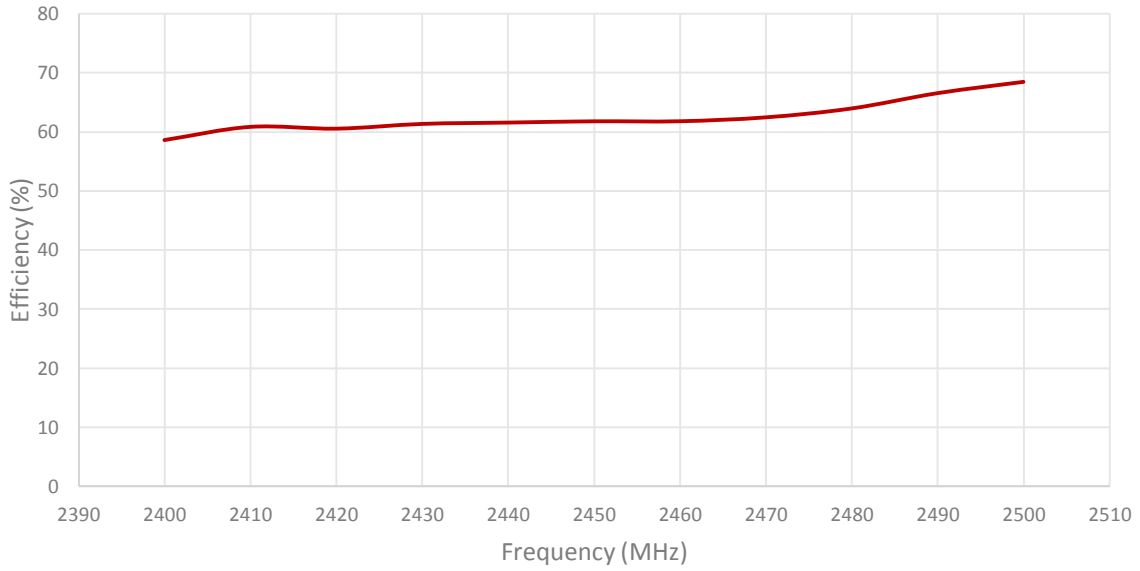

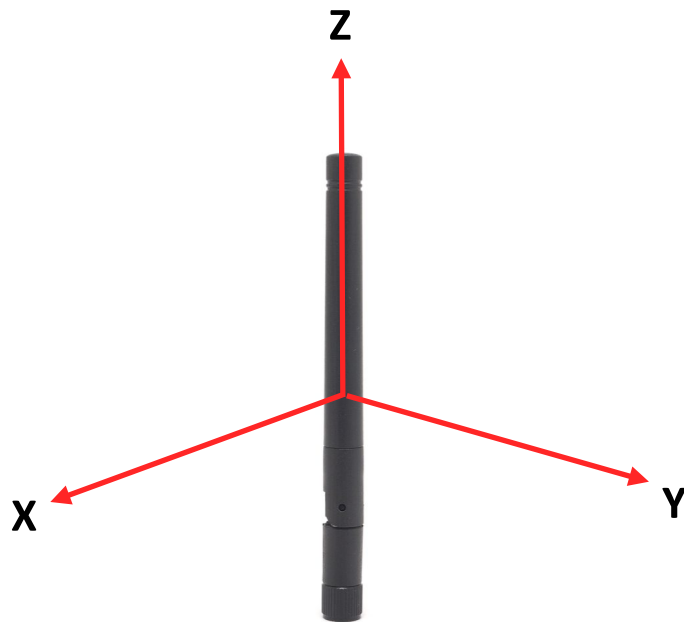
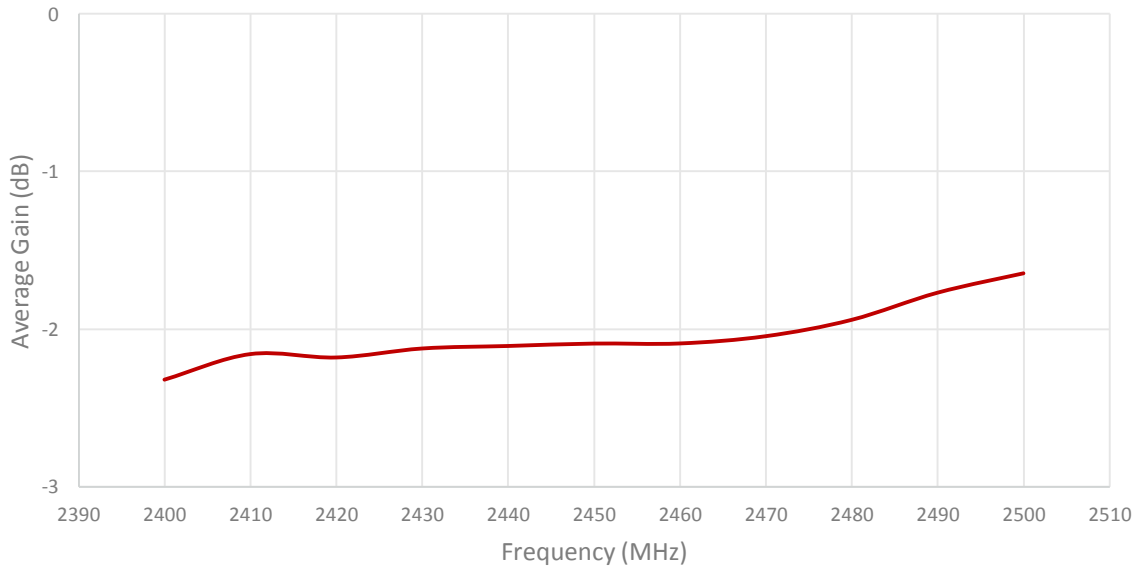

Radiation pattern reference

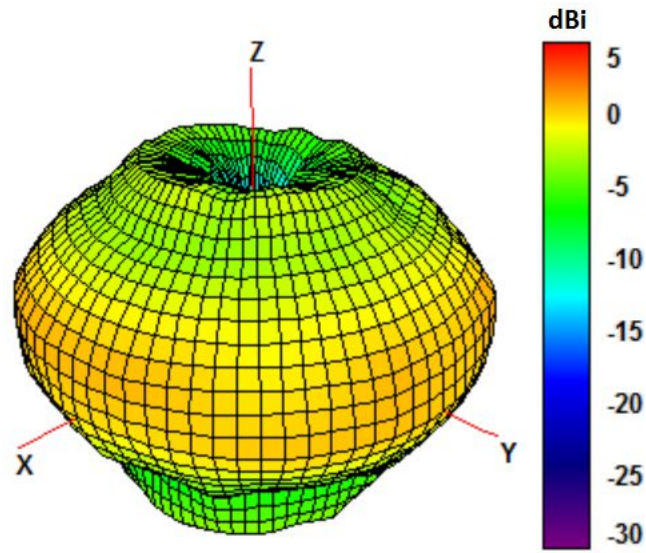

2450 MHz Radiation pattern

4. Antenna drawings

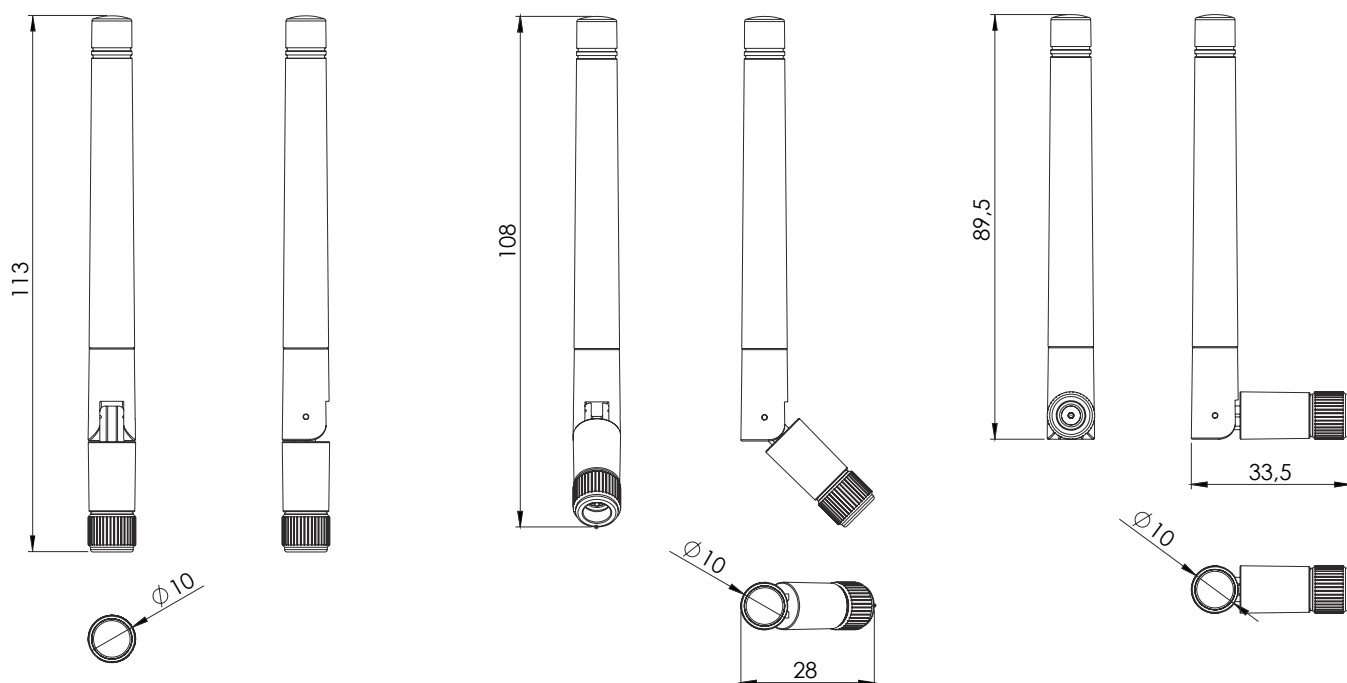

5. Antenna Images



X-ON Electronics

Largest Supplier of Electrical and Electronic Components

Click to view similar products for [Antennas](#) category:

Click to view products by [2J](#) manufacturer:

Other Similar products are found below :

[GAN30084EU](#) [930-033-R](#) [GW17.07.0250E](#) [1513563-1](#) [EXE902SM](#) [APAMPG-117](#) [MAF94383](#) [W3908B0100](#) [W6102B0100](#) [YE572113-30RSMM](#) [108-00014-50](#) [66089-2406](#) [SPDA17RP918](#) [A09-F8NF-M](#) [A09-F5NF-M](#) [RGFRA1903041A1T](#) [W3593B0100](#) [W3921B0100](#) [SIMNA-868](#) [SIMNA-915](#) [SIMNA-433](#) [W1044](#) [W1049B090](#) [A75-001](#) [WTL2449CQ1-FRSMM](#) [CPL9C](#) [EXB148BN](#) [0600-00060](#) [TRA9020S3PBN-001](#) [GD5W-28P-NF](#) [MA9-7N](#) [GD53-25](#) [GD5W-21P-NF](#) [C37](#) [MAF94051](#) [MA9-5N](#) [EXD420PL](#) [B1322NR](#) [QWFTB120](#) [MAF94300](#) [GPSMB301](#) [FG4403](#) [AO-AGSM-OM54](#) [5200232](#) [MIKROE-2349](#) [WCM.01.0111](#) [MIKROE-2393](#) [MIKROE-2352](#) [MIKROE-2350](#) [5200227](#)