

# 2JW1683

## 5GNR Connector Mount

### Key Features

#### 5GNR

- 617-960 MHz
- 1427-2690 MHz
- 3300-5000 MHz
- 5150-5925 MHz

Connector Mount

Ultra Wide band Antenna

High Performance

Super Low Profile

Ground Plane Dependent

Hinged Connector

Dimensions  $\varnothing 10 \times 80$  mm



## 1. Antenna and electrical specifications

Parameters	5GNR Antenna			
<b>Technologies</b>	5G, 4G, 3G and 2G			
<b>Standards</b>	5GNR/4GLTE/FirstNet/CBRS/LPWA/CAT-X/CAT-Mx/CAT-NBx/NB-IoT/3G/2G			
<b>Frequency (MHz)</b>	617-960	1427-2690	3300-5000	5150-5925
<b>Band (MHz)</b>	600, 700, 850, 900	1500, 1600, 1700, 1800, 1900, 2000, 2100, 2300, 2500, 2600	3300, 3500, 3600, 3700, 4500	5200, 5500, 5800
<b>5GNR Bands</b>	n5, n8, 12, n20, n28, n71, n81, n82, n83,	n1, n2, n3, n7, n25, n34, n38, n39, n40, n41, n50, n51, n66, n70, n74, n75, n76, n80, n84, n86	n77, n78, n79	
<b>4GLTE Bands</b>	B5, B6, B8, B12, B13, B14, B17, B18, B19, B20, B26, B27, B28, B29, B44, B67, B68, B71, B85	B1, B2, B3, B4, B7, B9, B10, B11, B21, B23, B24, B25, B30, B32, B33, B34, B35, B36, B37, B38, B39, B40, B41, B45, B50, B51, B65, B66, B69, B70, B74, B75, B76	B22, B42, B43, B48, B49, B52	B46, B47, B252, B255
<b>3GCELL Bands</b>	B5, B6, B8, B12, B13, B14, B19, B20, B26	B1, B2, B3, B4, B7, B9, B10, B11, B21, B25, B32, B33, B34, B35, B36, B37, B38, B39, B40	B22	
<b>2GCELL Bands</b>	710, 750, 810T, 850, 900P, 900E, 900R	1800DCS, 1900PCS		
<b>CDMACELL Bands</b>	BC0, BC2, BC3, BC7, BC9, BC10, BC12, BC18, BC19	BC1, BC4, BC6, BC8, BC13, BC14, BC15, BC16, BC20, BC21		
<b>Return Loss (dB)</b>	~-5.3	~-14.5	~-4.8	~-2.5
<b>VSWR</b>	~3.4:1	~1.7:1	~4.4:1	~7.0:1
<b>Efficiency (%)</b>	~51.3	~57.0	~31.3	~18.0
<b>Peak Gain (dBi)</b>	~0.6	~2.9	~0.2	~6.0
<b>Average Gain (dB)</b>	~-2.9	~-2.5	~-5.2	~-7.5
<b>Impedance (Ohm)</b>	50			
<b>Polarisation</b>	Linear			
<b>Radiation Pattern</b>	Omni-Directional			
<b>Max. Input Power (W)</b>	35			
<b>Connector Type</b>	SMA-Male			

### Antenna Measurement Conditions:

Mounted on 140 x 45 mm ground plane

Measured in Certified CTIA 3D Anechoic Chamber

## 2. Mechanical and environmental specifications

Specifications	2JW1683
<b>Mounting Type</b>	Connector Mount
<b>Dimensions (mm)</b>	Ø 10 × 80
<b>Antenna Base</b>	POM
<b>Radome color</b>	Black
<b>Connector Feature</b>	Hinged
<b>Operating Temperature (C)</b>	-40 to +85
<b>Storage Temperature (C)</b>	-40 to +85
<b>Substance Compliance</b>	RoHS

### 3. Antenna parameters

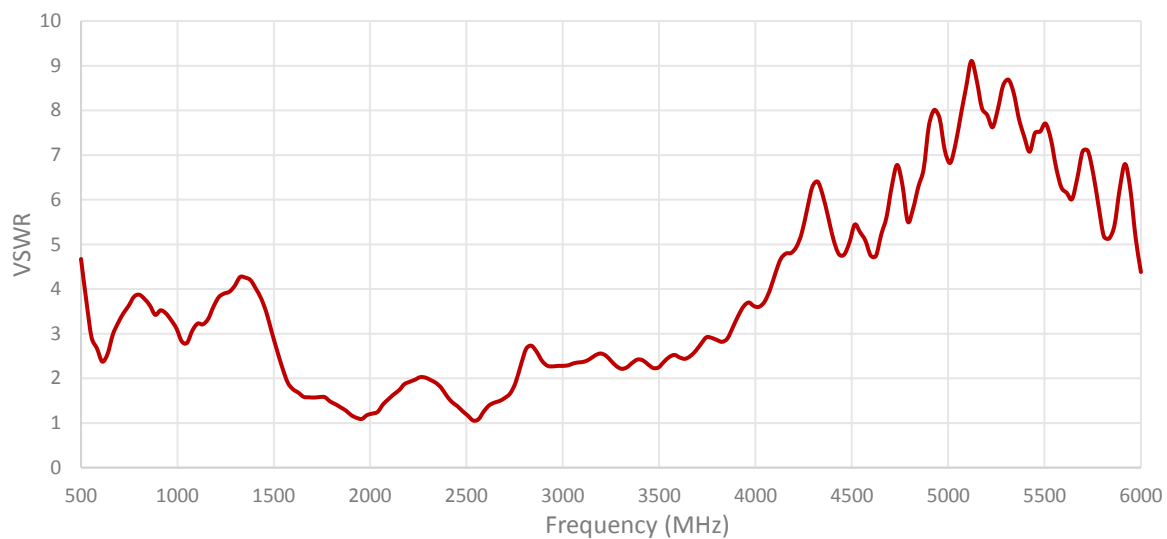
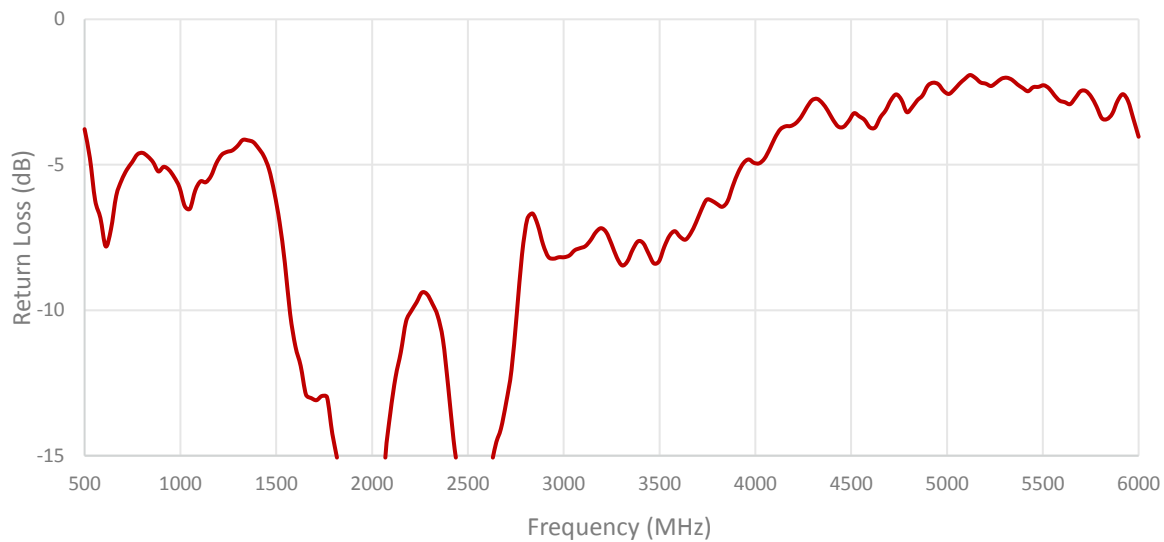

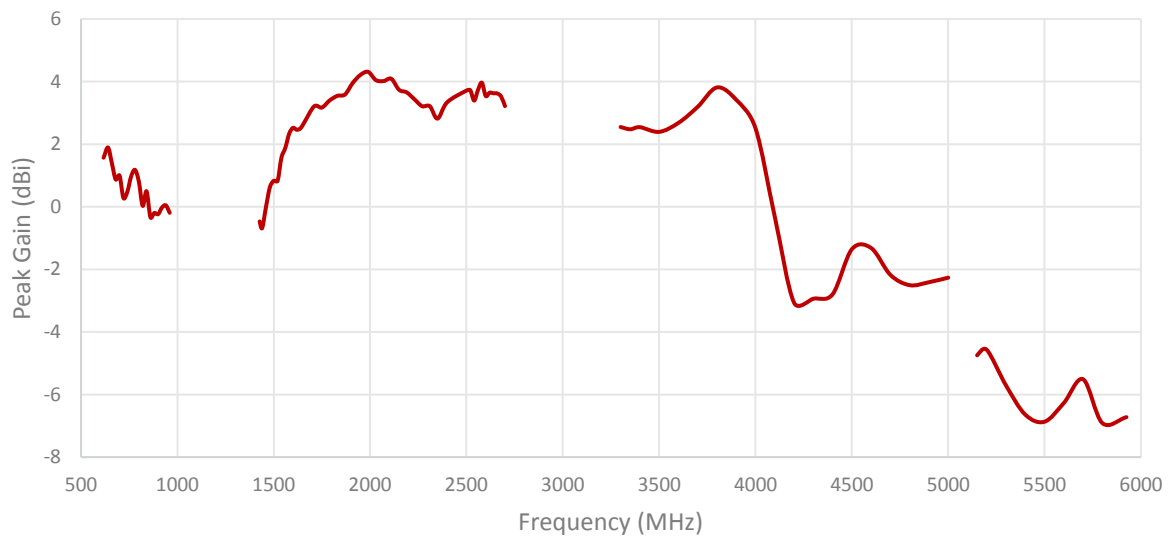
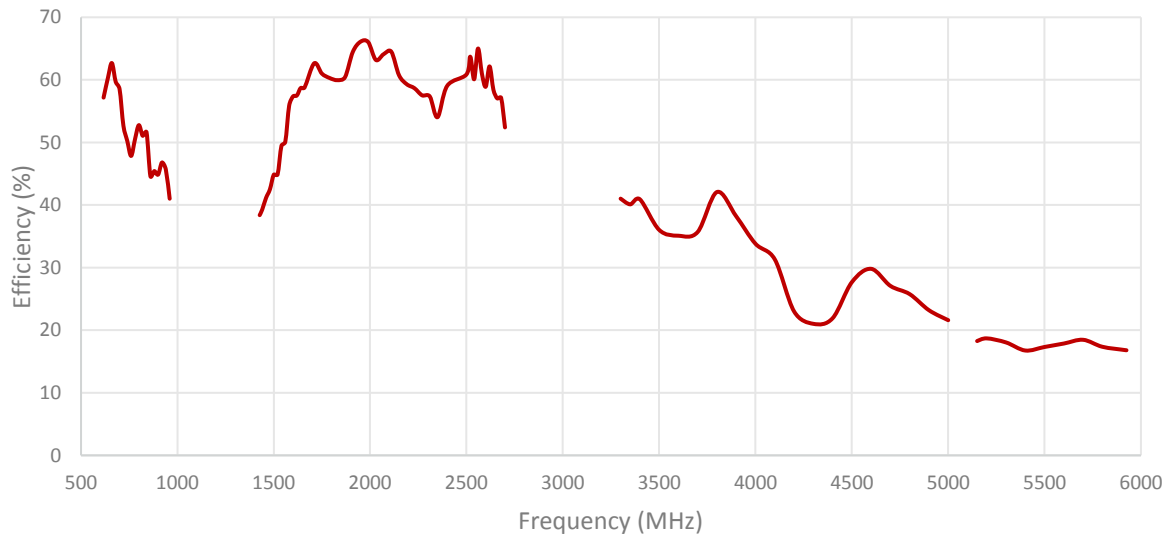

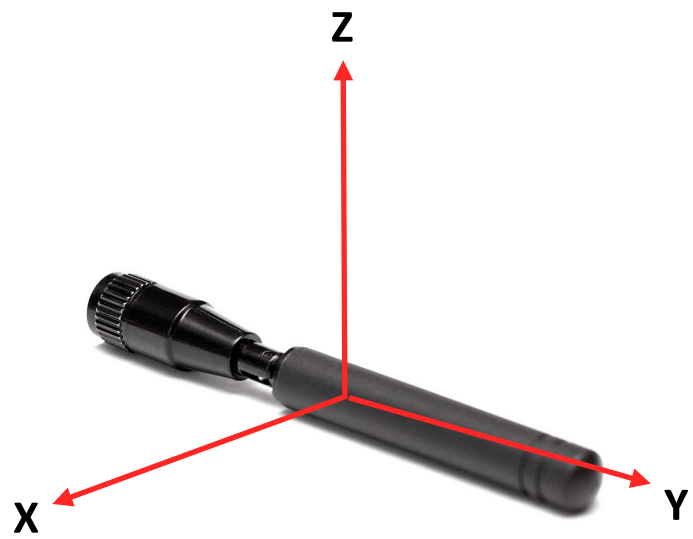
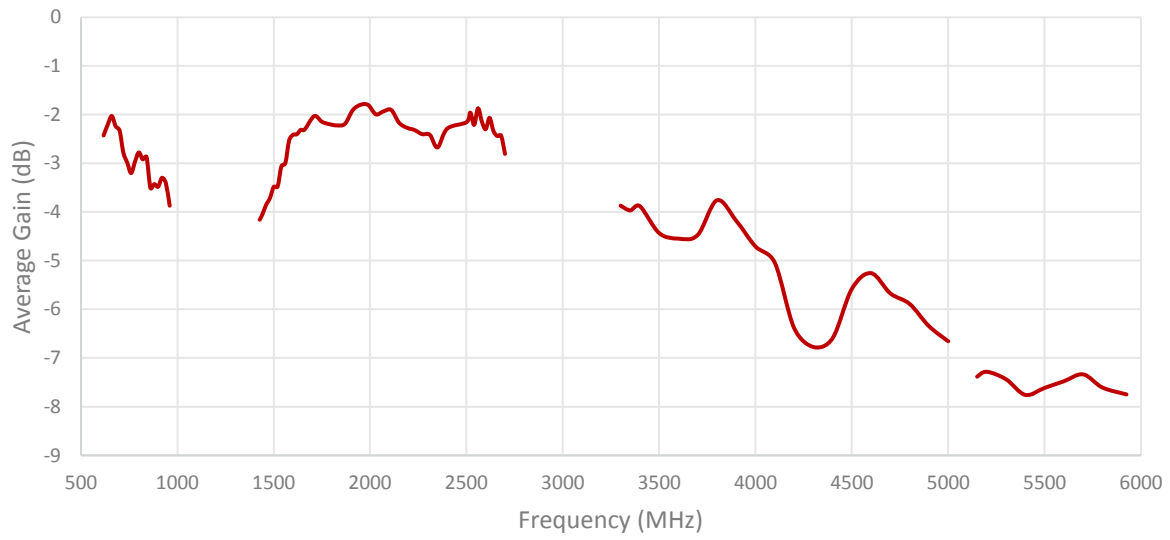

Radiation pattern reference

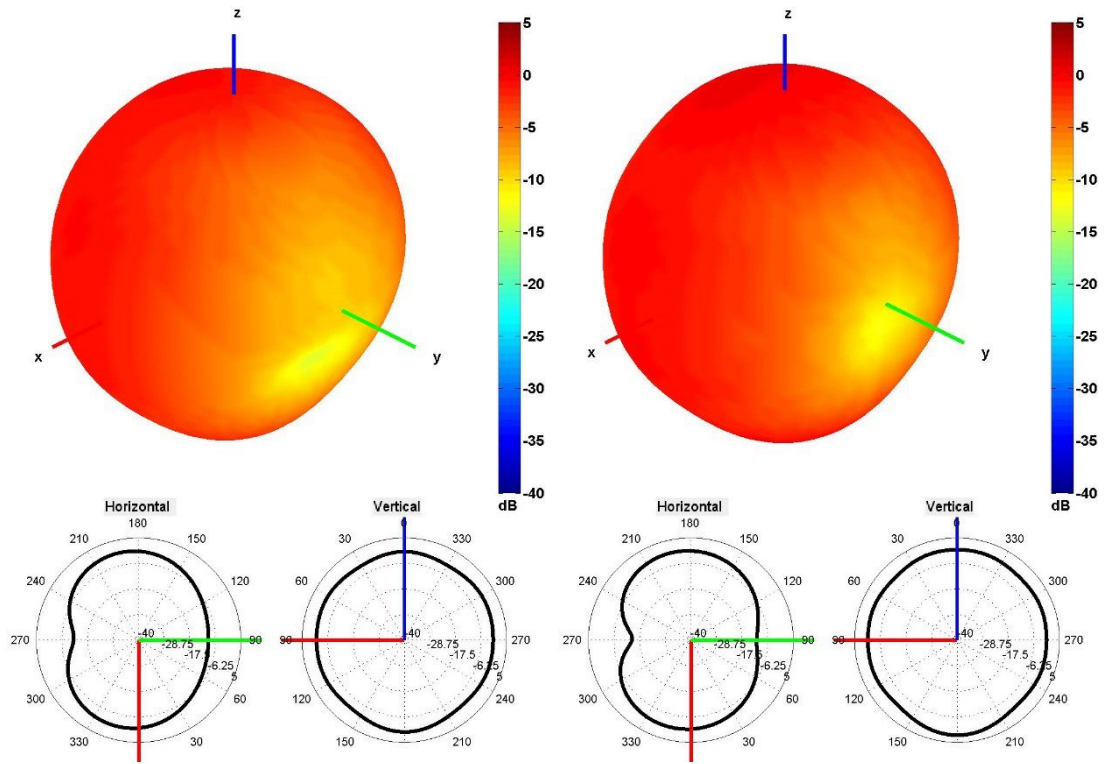

650 and 750 MHz Radiation pattern

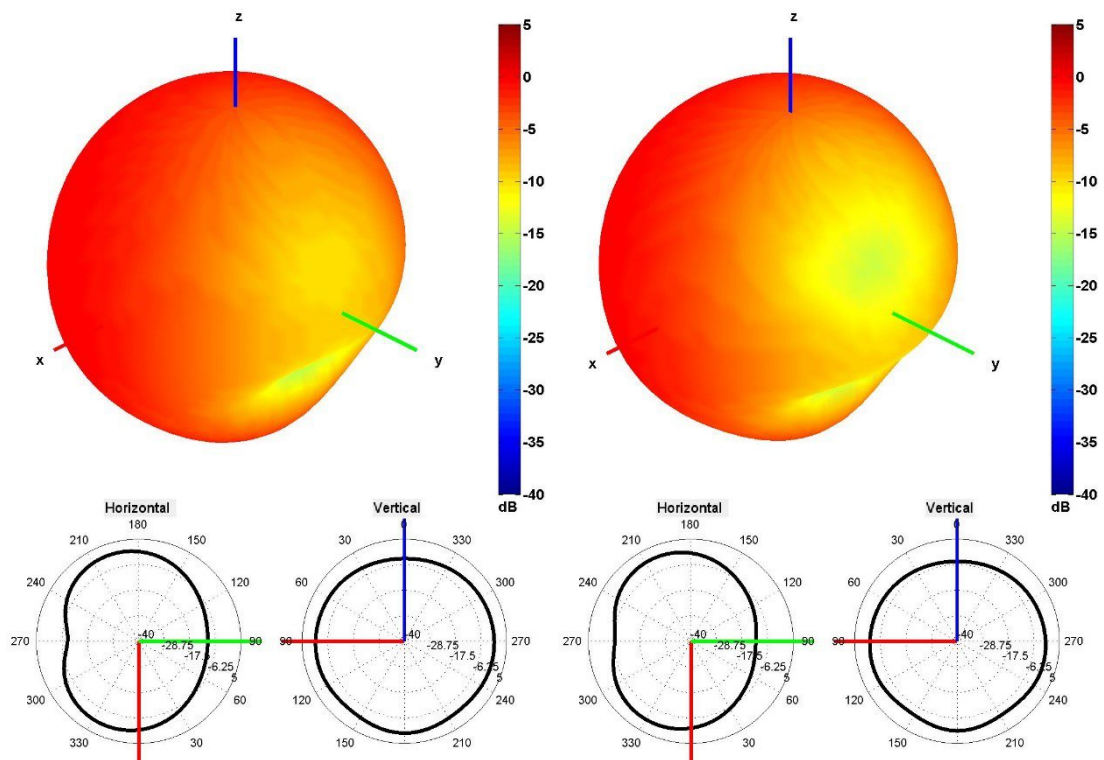

850 and 940 MHz Radiation pattern

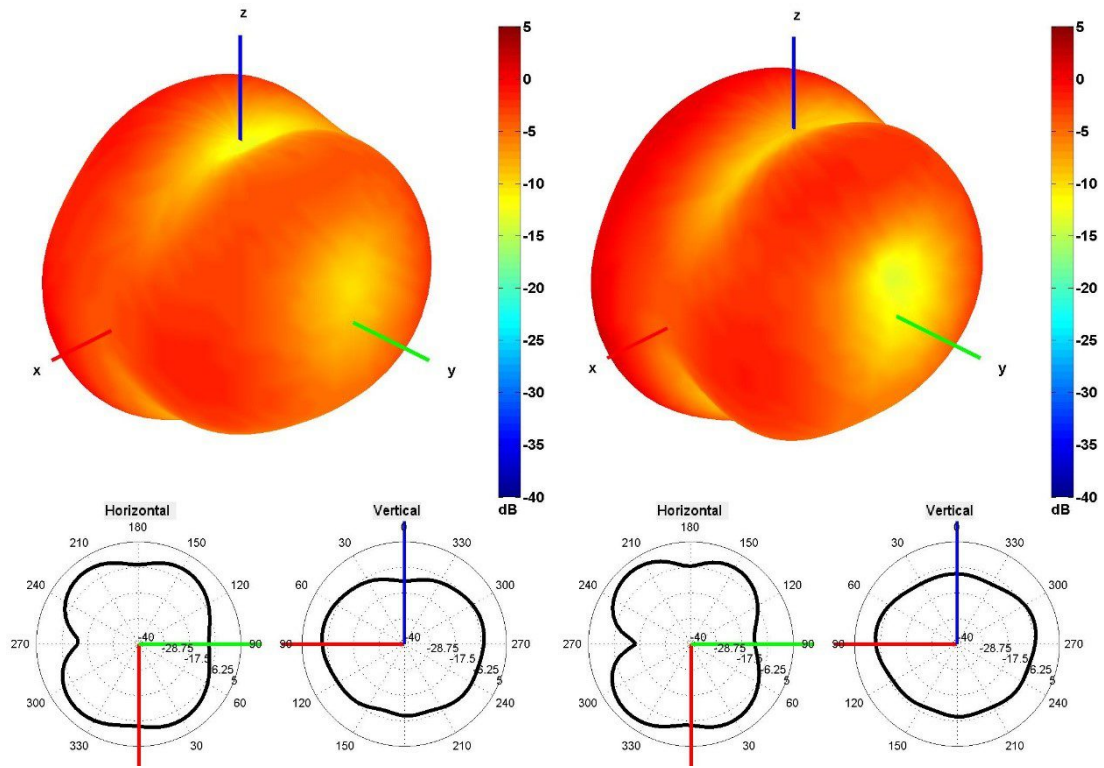

1500 and 1600 MHz Radiation pattern

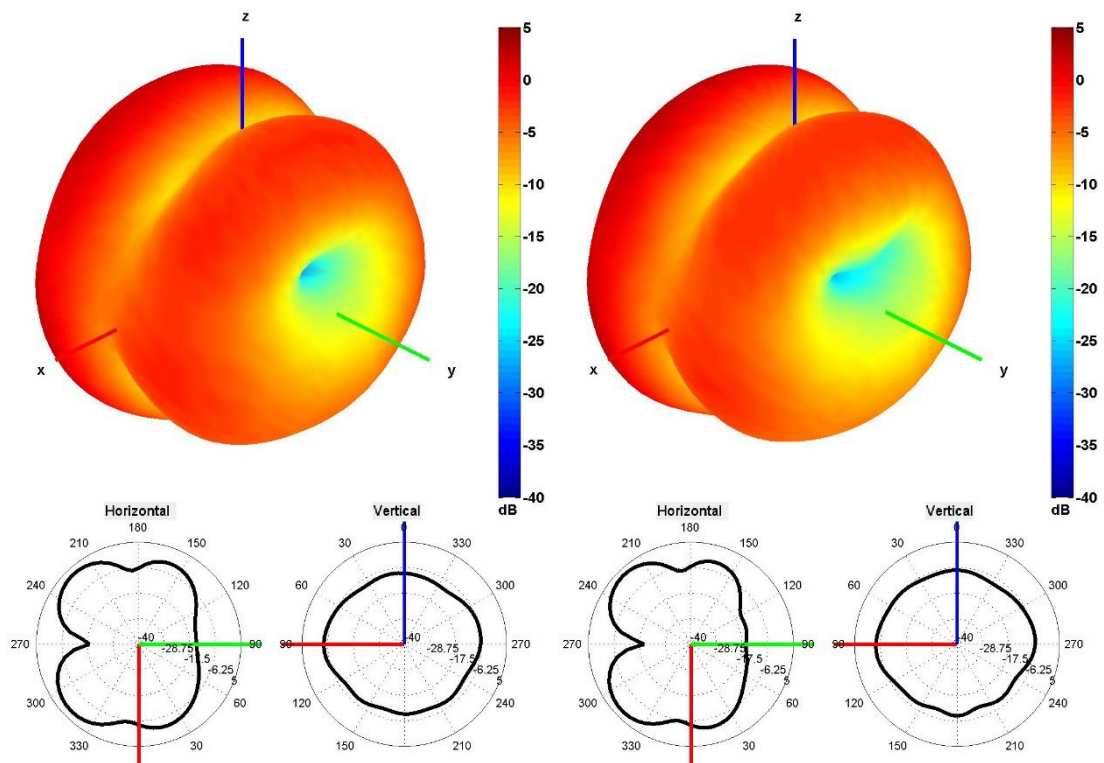

1750 and 1850 MHz Radiation pattern



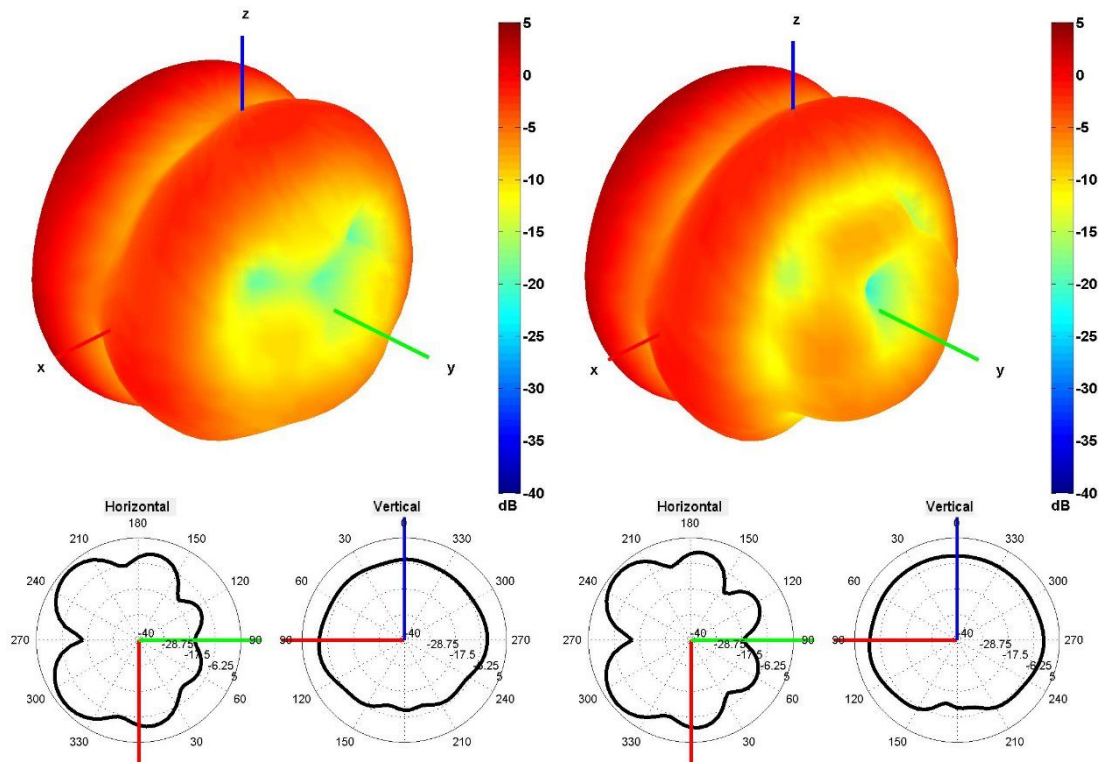

1950 and 2100 MHz Radiation pattern

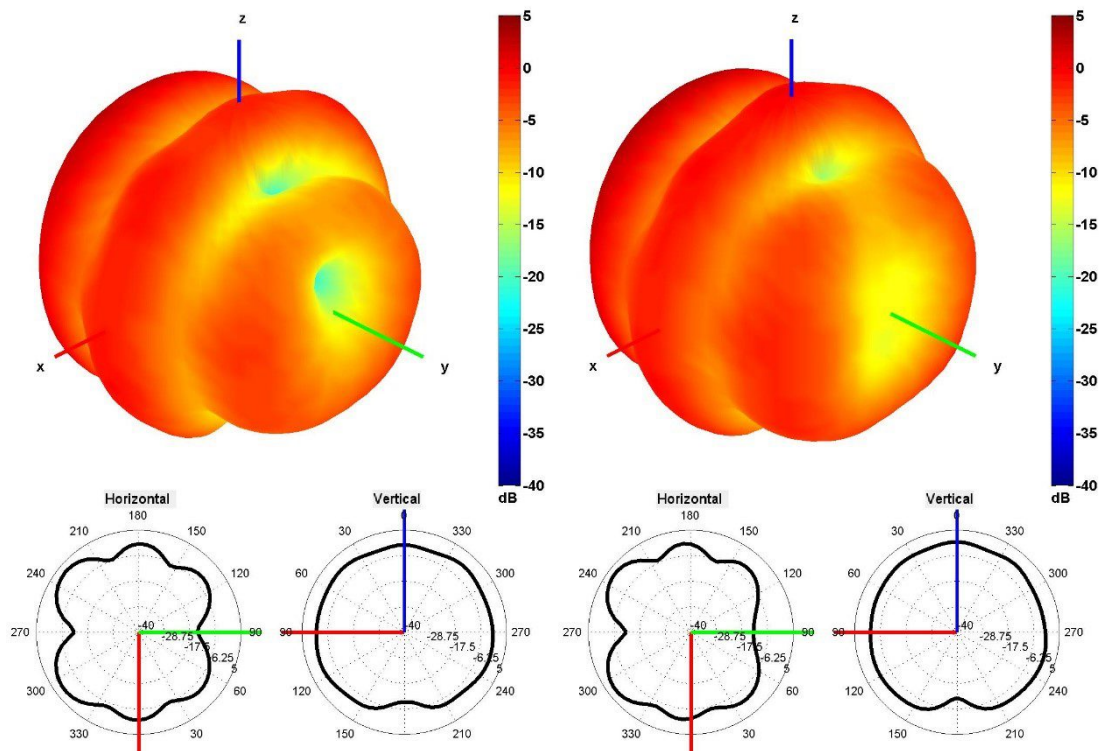

2350 and 2600 MHz Radiation pattern

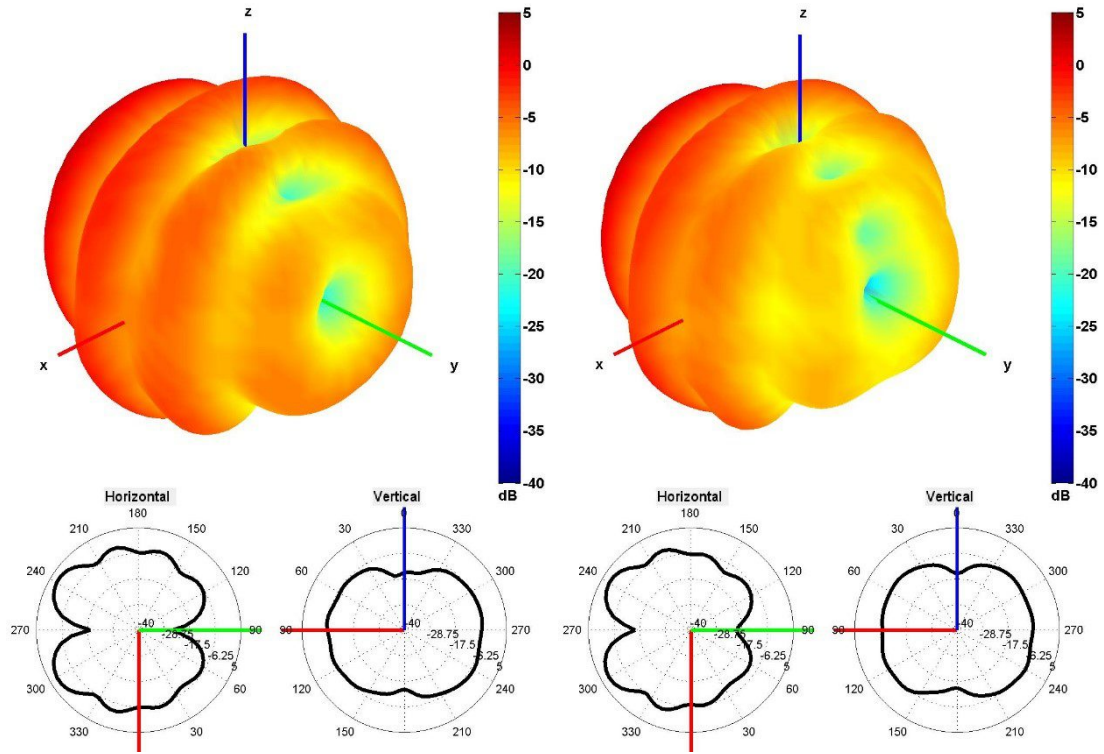

3350 and 3600 MHz Radiation pattern

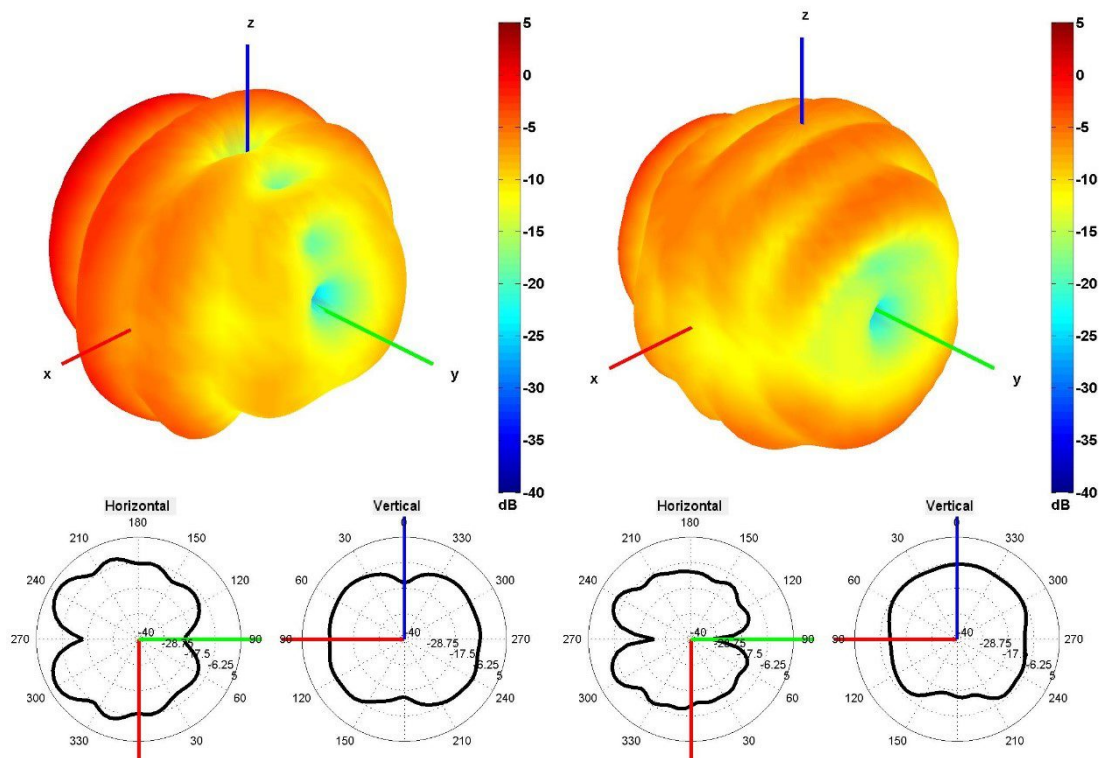

4500 and 5500 MHz Radiation pattern

## 4. Antenna drawings

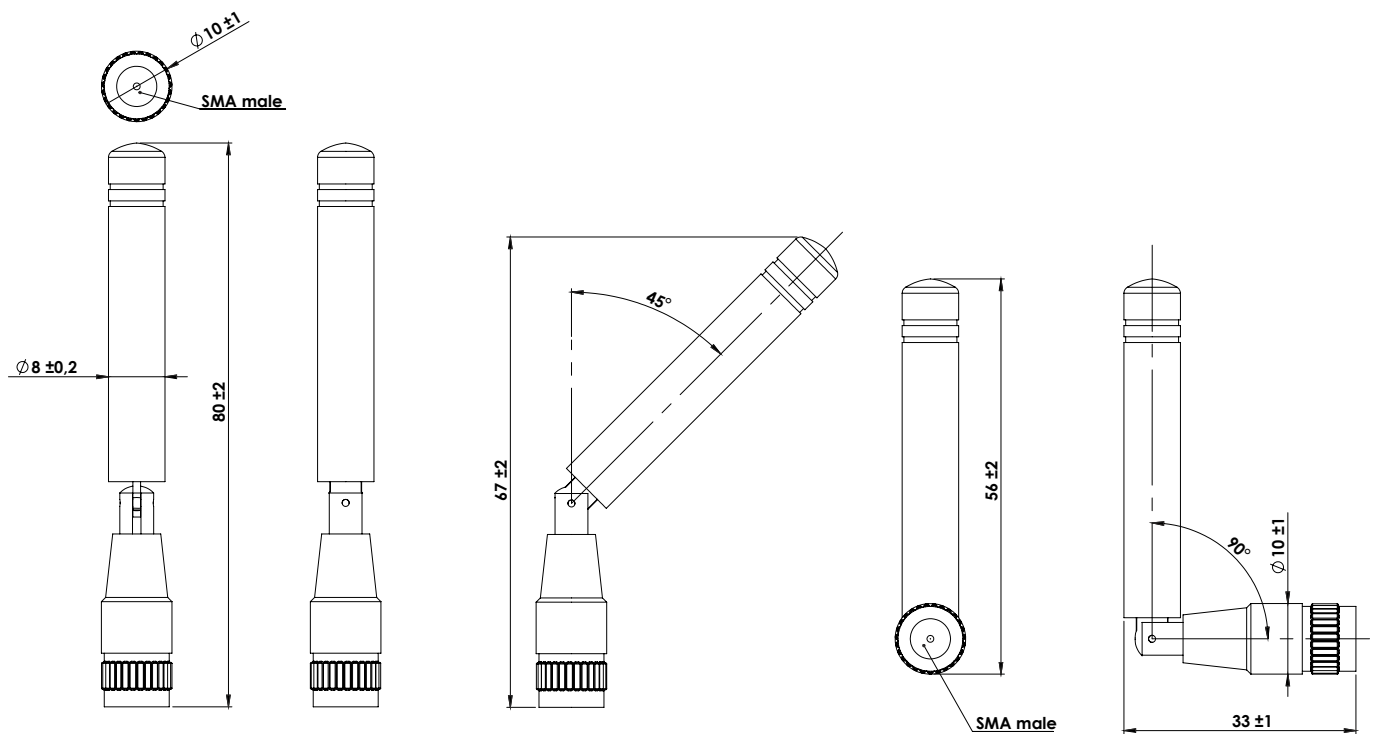

## 5. Antenna Images



## X-ON Electronics

Largest Supplier of Electrical and Electronic Components

*Click to view similar products for [Antennas](#) category:*

*Click to view products by [2J](#) manufacturer:*

Other Similar products are found below :

[930-033-R](#) [EXE902SM](#) [APAMPG-117](#) [66089-2406](#) [A09-F8NF-M](#) [A09-F5NF-M](#) [RGFRA1903041A1T](#) [108-00016-050](#) [W3525BW100](#)  
[SIMNA-868](#) [SIMNA-915](#) [SIMNA-433](#) [W1049B090](#) [TRABT1560](#) [WTL2449CQ1-FRSMM](#) [CPL9C](#) [0600-00060](#) [Y4503](#) [PAL90209H-FNF](#)  
[GD53-25](#) [C37](#) [MAF94051](#) [S9025PLSMF](#) [EXD420PL](#) [QWFTB120](#) [MAF94300](#) [FG4403](#) [MIKROE-2393](#) [GPSCPMM00](#) [ANTDOM-05-01-](#)  
[WPM](#) [ANT-WP868SMA-Y](#) [EXW30BNX](#) [RAD-ISM-2459-ANT-FOOD-6-0-](#) [S4908WBFNM](#) [GD57-21](#) [108-20131-010](#) [108-00032-010](#)  
[C27S](#) [CBNC58](#) [EXH160MXI](#) [EXH160SFK](#) [MD10-004](#) [EXC902SM](#) [CB27](#) [ABFT](#) [BB4502NR](#) [B4502N](#) [S4908WBFNF](#) [ANT-](#)  
[GSMGPSPUKS](#) [60210](#)