

FEATURES

Ultra-low power consumption (1Mbps): 0.75mA/Channel

High data rate: 10Mbps

High common-mode transient immunity: 75 kV/ μ s typical

High robustness to radiated and conducted noise

Low propagation delay:

8 ns typical for 5 V operation

9 ns typical for 3.3 V operation

Isolation voltages: AC 3000Vrms

High ESD rating:

ESDA/JEDEC JS-001-2017

Human body model (HBM) \pm 8kV

Safety and regulatory approvals:

UL certificate number: E494497

3000Vrms for 1 minute per UL 1577

CSA Component Acceptance Notice 5A

VDE certificate number: 40053041

DIN VDE V 0884-11:2017-01

$V_{IORM} = 565V$ peak

CQC certification per GB4943.1-2011

3 V to 5.5 V level translation

Wide temperature range: $-40^{\circ}C$ to $125^{\circ}C$

8-lead, RoHS-compliant, SOIC package

APPLICATIONS

General-purpose Single-channel isolation

Industrial field bus

Isolation Industrial automation systems

Isolated switch mode supplies

Isolated ADC, DAC

Motor control

GENERAL DESCRIPTION

The π 1xxxxx is a 2PaiSemi digital isolators product family that includes over hundreds of digital isolator products. By using matured standard semiconductor CMOS technology and 2PaiSEMI *iDivider*[®] technology, these isolation components provide outstanding performance characteristics and reliability superior to alternatives such as optocoupler devices and other integrated isolators.

Intelligent voltage divider technology (*iDivider*[®] technology) is a new generation digital isolator technology invented by 2PaiSEMI. It uses the principle of capacitor voltage divider to transmit voltage signal directly cross the isolator capacitor without signal modulation and demodulation.

The π 1xxxxx isolator data channels are independent and are available in a variety of configurations with a withstand voltage rating of 1.5 kV rms to 6.0 kV rms and the data rate from DC up to

600Mbps (see the Ordering Guide). The devices operate with the supply voltage on either side ranging from 3.0 V to 5.5 V, providing compatibility with lower voltage systems as well as enabling voltage translation functionality across the isolation barrier. The fail-safe state is available in which the outputs transition to a preset state when the input power supply is not applied.

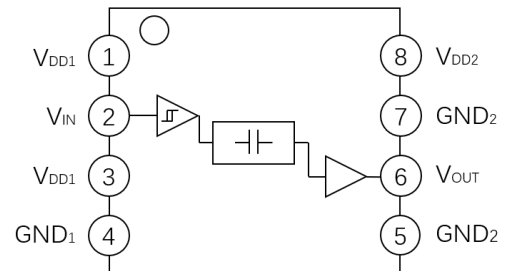
FUNCTIONAL BLOCK DIAGRAMS


Figure 1. π 110M3x functional Block Diagram

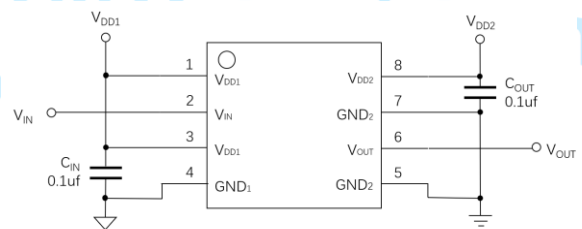
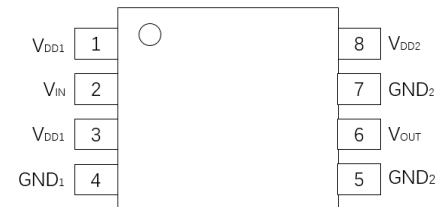


Figure 2. π 110M3x Typical Application Circuit

PIN CONFIGURATIONS AND FUNCTIONS

Table 1. π 110M3x Pin Function Descriptions

Pin No.	Name	Description
1	V _{DD1}	Supply Voltage for Isolator Side 1.
2	V _{IN}	Logic Input.
3	V _{DD1}	Supply Voltage for Isolator Side 1.
4	GND ₁	Ground 1. This pin is the ground reference for Isolator Side 1.
5	GND ₂	Ground 2. This pin is the ground reference for Isolator Side 2.
6	V _{OUT}	Logic Output.
7	GND ₂	Ground 2. This pin is the ground reference for Isolator Side 2.
8	V _{DD2}	Supply Voltage for Isolator Side 2.

Figure 3. π 110M3x Pin Configuration

ABSOLUTE MAXIMUM RATINGS

T_A = 25°C, unless otherwise noted.

Table 2. Absolute Maximum Ratings⁴

Parameter	Rating
Supply Voltages (V _{DD1} -GND ₁ , V _{DD2} -GND ₂)	-0.5 V to +7.0 V
Input Voltages ¹	-0.5 V to V _{DDx} + 0.5 V
Output Voltages ¹	-0.5 V to V _{DDx} + 0.5 V
Average Output Current per Pin ² Side 1 Output Current (I _{O1})	-10 mA to +10 mA
Average Output Current per Pin ² Side 2 Output Current (I _{O2})	-10 mA to +10 mA
Common-Mode Transients Immunity ³	-200 kV/μs to +200 kV/μs
Storage Temperature (T _{ST}) Range	-65°C to +150°C
Ambient Operating Temperature (T _A) Range	-40°C to +125°C

Notes:

¹ V_{DDx} is the side voltage power supply V_{DD}, where x = 1 or 2.

² See Figure 4 for the maximum rated current values for various temperatures.

³ See Figure 11 for Common-mode transient immunity (CMTI) measurement.

⁴ Stresses at or above those listed under Absolute Maximum Ratings may cause permanent damage to the device. These are stress rating only; functional operation of the device at these or any other conditions above those indicated in the operational section of this specification is not implied. Operation beyond the maximum operating conditions for extended periods may affect product reliability.

RECOMMENDED OPERATING CONDITIONS

Table 3. Recommended Operating Conditions

Parameter	Symbol	Min	Typ	Max	Unit
Supply Voltage	V _{DDx} ¹	3		5.5	V
High Level Input Signal Voltage	V _{IH}	0.7*V _{DDx} ¹		V _{DDx} ¹	V
Low Level Input Signal Voltage	V _{IL}	0		0.3*V _{DDx} ¹	V
High Level Output Current	I _{OH}	-6			mA
Low Level Output Current	I _{OL}			6	mA
Data Rate		0		10	Mbps
Junction Temperature	T _J	-40		150	°C
Ambient Operating Temperature	T _A	-40		125	°C

Notes:

¹ V_{DDx} is the side voltage power supply V_{DD}, where x = 1 or 2.

Truth Tables

Table 4. π 110xxx Truth Table

V _{ix} Input ¹	V _{DD1} State ¹	V _{DD0} State ¹	Default Low V _{Ox} Output ¹	Default High V _{Ox} Output ¹	Test Conditions /Comments
Low	Powered ²	Powered ²	Low	Low	Normal operation
High	Powered ²	Powered ²	High	High	Normal operation
Open	Powered ²	Powered ²	Low	High	Default output
Don't Care ⁴	Unpowered ³	Powered ²	Low	High	Default output ⁵
Don't Care ⁴	Powered ²	Unpowered ³	High Impedance	High Impedance	

Notes:

¹ V_{ix}/V_{Ox} are the input/output signals of a given channel (A or B). V_{DD1}/V_{DD0} are the supply voltages on the input/output signal sides of this given channel.² Powered means V_{DDx} ≥ 2.95 V³ Unpowered means V_{DDx} < 2.30V⁴ Input signal (V_{ix}) must be in a low state to avoid powering the given V_{DD1} through its ESD protection circuitry.⁵ If the V_{DD1} goes into unpowered status, the channel outputs the default logic signal after around 1 μ s. If the V_{DD1} goes into powered status, the channel outputs the input status logic signal after around 1 μ s.

SPECIFICATIONS

ELECTRICAL CHARACTERISTICS

Table 5. Switching Specifications

V_{DD1} - V_{GND1} = V_{DD2} - V_{GND2} = 3.3V_{DC} ± 10% or 5V_{DC} ± 10%, T_A = 25°C, unless otherwise noted.

Parameter	Symbol	Min	Typ	Max	Unit	Test Conditions/Comments
Minimum Pulse Width	PW			100	ns	Within pulse width distortion (PWD) limit
Maximum Data Rate					Mbps	Within PWD limit
Propagation Delay Time ¹	t _{pHL} , t _{pLH}	5.5	8	12.5	ns	@ 5V _{DC} supply
		6.5	9	13.5	ns	@ 3.3V _{DC} supply
Pulse Width Distortion	PWD	0	0.3	3.0	ns	The max different time between t _{pHL} and t _{pLH} @ 5V _{DC} supply. And The value is t _{pHL} - t _{pLH}
		0	0.3	3.0	ns	@ 3.3V _{DC} supply
Part to Part Propagation Delay Skew	t _{PSK}			2	ns	The max different propagation delay time between any two devices at the same temperature, load and voltage @ 5V _{DC} supply
				2	ns	@ 3.3V _{DC} supply
Output Signal Rise/Fall Time ⁴	t _r /t _f		1.5		ns	See Figure 7.
Dynamic Input Supply Current per Channel	I _{DD1 (D)}		9		μ A /Mbps	Inputs switching, 50% duty cycle square wave, CL = 0 pF @ 5V _{DC} Supply
Dynamic Output Supply Current per Channel	I _{DD0 (D)}		38		μ A /Mbps	Inputs switching, 50% duty cycle square wave, CL = 0 pF @ 5V _{DC} Supply
Dynamic Input Supply Current per Channel	I _{DD1 (D)}		5		μ A /Mbps	Inputs switching, 50% duty cycle square wave, CL = 0 pF @ 3.3V _{DC} Supply
Dynamic Output Supply Current per Channel	I _{DD0 (D)}		23		μ A /Mbps	Inputs switching, 50% duty cycle square wave, CL = 0 pF @ 3.3V _{DC} Supply
Common-Mode Transient Immunity ³	CMTI		75		kV/ μ s	V _{IN} = V _{DDx} ² or 0V, V _{CM} = 1000 V
Jitter			120		ps p-p	See the Jitter Measurement section
			20		ps rms	
ESD(HBM - Human body model)	ESD		±8		kV	

Notes:

¹ t_{pLH} = low-to-high propagation delay time, t_{pHL} = high-to-low propagation delay time. See Figure 8.² V_{DDx} is the side voltage power supply V_{DD}, where x = 1 or 2.³ See Figure 11 for Common-mode transient immunity (CMTI) measurement.⁴ t_r means is the time from 10% amplitude to 90% amplitude of the rising edge of the signal, t_f means is the time from 90% amplitude to 10% amplitude of the falling edge of the signal.

Table 6. DC Specifications

VDD1 - VGND1 = VDD2 - VGND2 = 3.3VDC±10% or 5VDC±10%, TA=25°C, unless otherwise noted.

	Symbol	Min	Typ	Max	Unit	Test Conditions/Comments
Rising Input Signal Voltage Threshold	V _{IT+}		0.6*V _{DDX} ¹	0.7*V _{DDX} ¹	V	
Falling Input Signal Voltage Threshold	V _{IT-}	0.3* V _{DDX} ¹	0.4* V _{DDX} ¹		V	
High Level Output Voltage	V _{OH} ¹	V _{DDX} - 0.1	V _{DDX}		V	-20 μA output current
		V _{DDX} - 0.2	V _{DDX} - 0.1		V	-2 mA output current
Low Level Output Voltage	V _{OL}	0	0.1		V	20 μA output current
		0.1	0.2		V	2 mA output current
Input Current per Signal Channel	I _{IN}	-10	0.5	10	μA	0 V ≤ Signal voltage ≤ V _{DDX} ¹
V _{DDX} ¹ Undervoltage Rising Threshold	V _{DDXUV+}	2.45	2.75	2.95	V	
V _{DDX} ¹ Undervoltage Falling Threshold	V _{DDXUV-}	2.30	2.60	2.75	V	
V _{DDX} ¹ Hysteresis	V _{DDXUVH}		0.15		V	

Notes:

¹ V_{DDX} is the side voltage power supply V_{DD}, where x = 1 or 2.

Table 7. Quiescent Supply Current

VDD1 - VGND1 = VDD2 - VGND2 = 3.3VDC±10% or 5VDC±10%, TA=25°C, CL = 0 pF, unless otherwise noted.

Part	Symbol	Min	Typ	Max	Unit	Test Conditions	
						Supply voltage	Input signal
π110M3x	I _{DD1} (Q)	0.06	0.08	0.10	mA	5V _{DC}	VI=0V for π110M30
	I _{DD2} (Q)	0.47	0.59	0.76	mA		VI=5V for π110M31
	I _{DD1} (Q)	0.15	0.19	0.25	mA		VI=5V for π110M30
	I _{DD2} (Q)	0.44	0.55	0.72	mA		VI=0V for π110M31
	I _{DD1} (Q)	0.06	0.08	0.10	mA	3.3V _{DC}	VI=0V for π110M30
	I _{DD2} (Q)	0.46	0.58	0.75	mA		VI=3.3V for π110M31
	I _{DD1} (Q)	0.11	0.14	0.18	mA		VI=3.3V for π110M30
	I _{DD2} (Q)	0.43	0.53	0.69	mA		VI=0V for π110M31

Table 8. Total Supply Current vs. Data Throughput (CL = 0 pF)

VDD1 - VGND1 = VDD2 - VGND2 = 3.3VDC±10% or 5VDC±10%, TA=25°C, CL = 0 pF, unless otherwise noted.

Part	Symbol	150 Kbps			1 Mbps			10 Mbps			Unit	Supply voltage
		Min	Typ	Max	Min	Typ	Max	Min	Typ	Max		
π110M3x	I _{DD1}	0.12	0.18		0.13	0.20		0.30	0.50		mA	5V _{DC}
	I _{DD2}	0.57	0.86		0.61	0.92		1.06	1.58			
	I _{DD1}	0.10	0.15		0.11	0.17		0.16	0.24		mA	3.3V _{DC}
	I _{DD2}	0.56	0.84		0.58	0.87		0.86	1.29			

INSULATION AND SAFETY RELATED SPECIFICATIONS

Table 9. Insulation Specifications

Parameter	Symbol	Value	Unit	Test Conditions/Comments
Rated Dielectric Insulation Voltage		3000	V rms	1-minute duration
Minimum External Air Gap (Clearance)	L (CLR)	≥4	mm	Measured from input terminals to output terminals, shortest distance through air
Minimum External Tracking (Creepage)	L (CRP)	≥4	mm	Measured from input terminals to output terminals, shortest distance path along body
Minimum Internal Gap (Internal Clearance)		≥11	μm	Insulation distance through insulation
Tracking Resistance (Comparative Tracking Index)	CTI	>400	V	DIN EN 60112 (VDE 0303-11):2010-05
Material Group		II		IEC 60112:2003 + A1:2009

PACKAGE CHARACTERISTICS

Table 10.Package Characteristics

Parameter	Symbol	Typical Value	Unit	Test Conditions/Comments
Resistance (Input to Output) ¹	R _{IO}	10 ¹¹	Ω	
Capacitance (Input to Output) ¹	C _{IO}	0.6	pF	@1MHz
Input Capacitance ²	C _I	3.0	pF	@1MHz
IC Junction to Ambient Thermal Resistance	θ_{JA}	100	$^{\circ}\text{C}/\text{W}$	Thermocouple located at center of package underside

Notes:

¹The device is considered a 2-terminal device; SOIC-8 Pin 1 - Pin 4 are shorted together as the one terminal, and SOIC-8 Pin 5 - Pin 8 are shorted together as the other terminal.

²Testing from the input signal pin to ground.

REGULATORY INFORMATION

See Table 11 for details regarding recommended maximum working voltages for specific cross isolation waveforms and insulation levels.

Table 11.Regulatory

Regulatory	π 110M3x
UL	Recognized under UL 1577 Component Recognition Program ¹ Single Protection, 3000 V rms Isolation Voltage File (E494497)
VDE	DIN VDE V 0884-11:2017-01 Basic insulation, V _{IORM} = 565V peak, V _{IOSM} = 3615 V peak File (40053041)
CQC	Certified under CQC11-471543-2012, GB4943.1-2011 Basic insulation at 500 V rms (707 V peak) working voltage Reinforced insulation at 250 V rms (353 V peak) NB SOIC-8 File (CQC20001260211)

Notes:

¹ In accordance with UL 1577, each π 110M3x is proof tested by applying an insulation test voltage \geq 3600 V rms for 1 sec

² In accordance with DIN V VDE V 0884-11, each π 110M3x is proof tested by applying an insulation test voltage \geq 848V peak for 1 sec (partial discharge detection limit = 5 pC).

DIN V VDE V 0884-11 (VDE V 0884-11) INSULATION CHARACTERISTICS

Table 12.VDE Insulation Characteristics

Description	Test Conditions/Comments	Symbol	Characteristic	Unit
Installation Classification per DIN VDE 0110 For Rated Mains Voltage \leq 150 V rms For Rated Mains Voltage \leq 300 V rms For Rated Mains Voltage \leq 400 V rms			I to IV I to III I to III	
Climatic Classification			40/105/21	
Pollution Degree per DIN VDE 0110, Table 1			2	
Maximum repetitive peak isolation voltage		V _{IORM}	565	Vpeak
Input to Output Test Voltage, Method B1	V _{IORM} \times 1.5 = V _{pd(m)} , 100% production test, t _{ini} = t _m = 1 sec, partial discharge < 5 pC	V _{pd(m)}	848	Vpeak
Input to Output Test Voltage, Method A After Environmental Tests Subgroup 1	V _{IORM} \times 1.2 = V _{pd(m)} , t _{ini} = 60 sec, t _m = 10 sec, partial discharge < 5 pC	V _{pd(m)}	678	Vpeak
After Input and/or Safety Test Subgroup 2 and Subgroup 3	V _{IORM} \times 1.2 = V _{pd(m)} , t _{ini} = 60 sec, t _m = 10 sec, partial discharge < 5 pC	V _{pd(m)}	678	Vpeak
Highest Allowable Overvoltage		V _{IOTM}	4200	Vpeak

Description	Test Conditions/Comments	Symbol	Characteristic	Unit
Surge Isolation Voltage Basic	Basic insulation, 1.2/50 μ s combination wave, $V_{TEST} = 1.3 \times V_{IOSM}$ (qualification) ¹	V_{IOSM}	3615	V _{peak}
Safety Limiting Values	Maximum value allowed in the event of a failure (see Figure 4)			
Maximum Safety Temperature		T_S	150	$^{\circ}$ C
Maximum Power Dissipation at 25 $^{\circ}$ C		P_S	1.25	W
Insulation Resistance at T_S	$V_{IO} = 500$ V	R_S	$>10^9$	Ω

Notes:

¹In accordance with DIN V VDE V 0884-11, π 1xxx3x is proof tested by applying a surge isolation voltage 4700 V.

Typical Thermal Characteristic

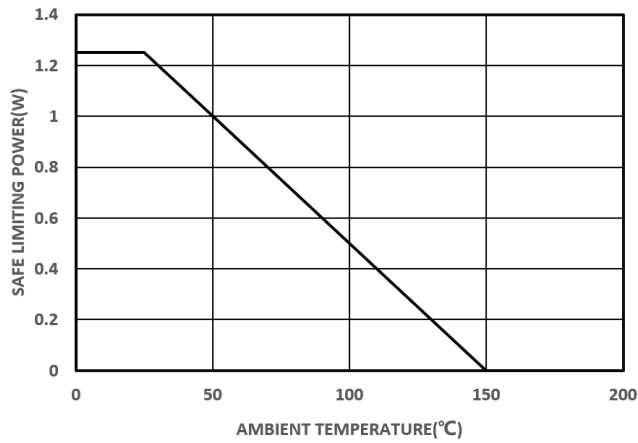


Figure 4. Thermal Derating Curve, Dependence of Safety Limiting Values with Ambient Temperature per VDE

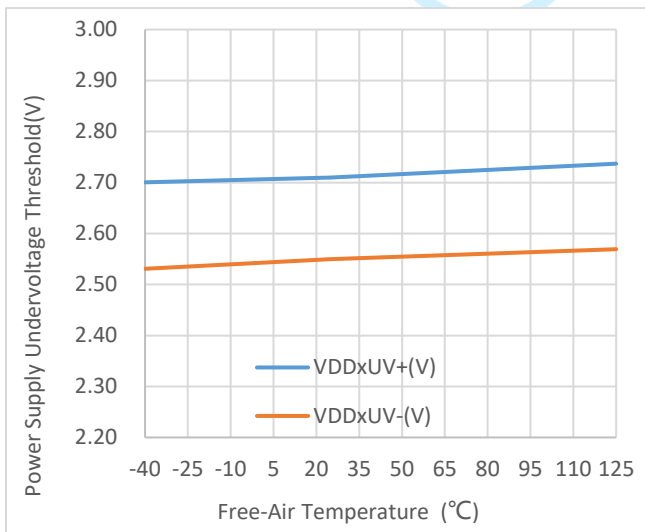


Figure 5. UVLO vs. Free-Air Temperature

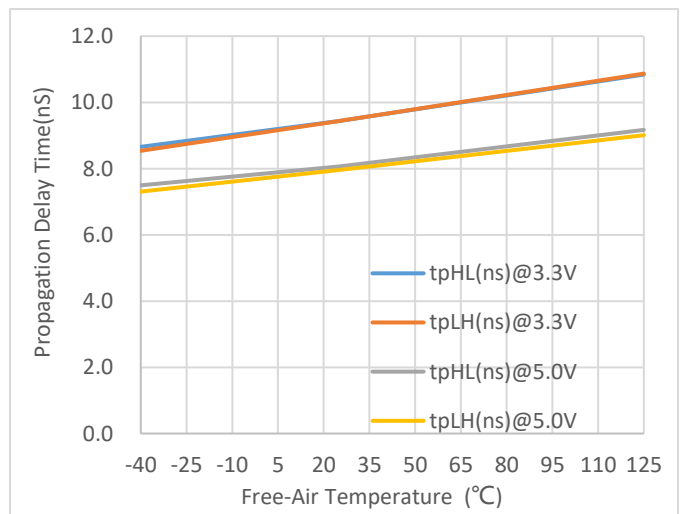


Figure 6. Propagation Delay Time vs. Free-Air Temperature

Timing test information

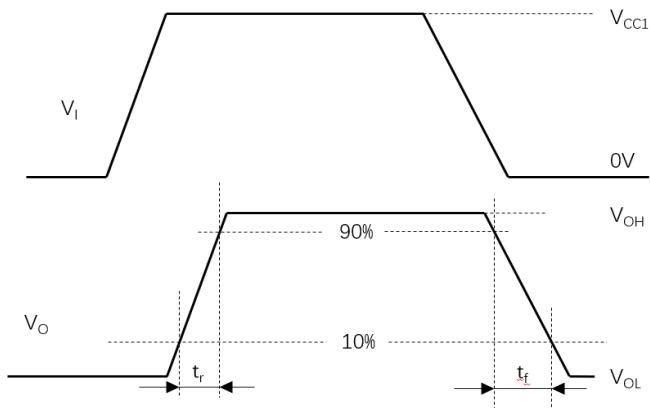


Figure 7. Transition time waveform measurement

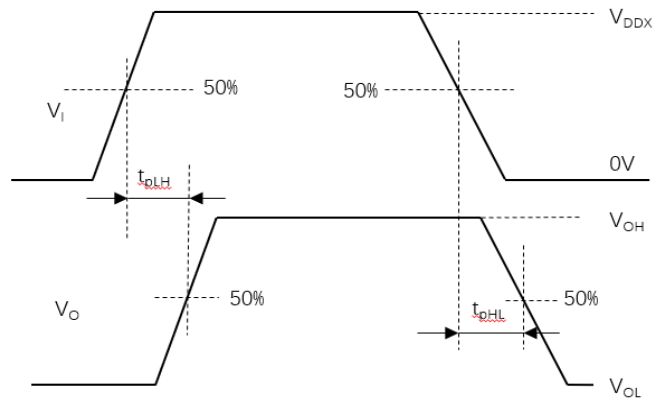


Figure 8. Propagation delay time waveform measurement



APPLICATIONS INFORMATION

OVERVIEW

The π 1xxxxx are 2PaiSemi digital isolators product family based on 2PaiSEMI unique *iDivider*[®] technology. Intelligent voltage *Divider* technology (*iDivider*[®] technology) is a new generation digital isolator technology invented by 2PaiSEMI. It uses the principle of capacitor voltage divider to transmit signal directly cross the isolator capacitor without signal modulation and demodulation. Compare to the traditional Opto-couple technology, icoupler technology, OOK technology, *iDivider*[®] is a more essential and concise isolation signal transmit technology which leads to greatly simplification on circuit design and therefore significantly improves device performance, such as lower power consumption, faster speed, enhanced anti-interference ability, lower noise.

By using matured standard semiconductor CMOS technology and the innovative *iDivider*[®] design, these isolation components provide outstanding performance characteristics and reliability superior to alternatives such as optocoupler devices and other integrated isolators. The π 1xxxxx isolator data channels are independent and are available in a variety of configurations with a withstand voltage rating of 1.5 kV rms to 5.0 kV rms and the data rate from DC up to 600Mbps (see the Ordering Guide).

The π 110M3x are the outstanding 10 Mbps single-channel digital isolators with the enhanced ESD capability. the devices transmit data across an isolation barrier by layers of silicon dioxide isolation.

The devices operate with the supply voltage on either side ranging from 3.0 V to 5.5 V, offering voltage translation of 3.3 V, and 5 V logic. The π 110M3x have very low propagation delay and high speed. The input/output design techniques allow logic and supply voltages over a wide range from 3.0 V to 5.5 V, offering voltage translation of 3.3 V, and 5 V logic. The architecture is designed for high common-mode transient immunity and high immunity to electrical noise and magnetic interference.

See the Ordering Guide for the model numbers that have the fail-safe output state of low or high.

PCB LAYOUT

The low-ESR ceramic bypass capacitors must be connected between V_{DD1} and GND_1 and between V_{DD2} and GND_2 . The bypass capacitors are placed on the PCB as close to the isolator device as possible. The recommended bypass capacitor value is between 0.1 μ F and 10 μ F. To enhance the robustness of a design, the user may also include resistors (50–300 Ω) in series with the inputs and outputs if the system is excessively noisy.

Avoid reducing the isolation capability, Keep the space underneath the isolator device free from metal such as planes, pads, traces and vias.

To minimize the impedance of the signal return loop, keep the solid ground plane directly underneath the high-speed signal path, the closer the better. The return path will couple between the nearest ground plane to the signal path. Keep suitable trace width for controlled impedance transmission lines interconnect.

To reduce the rise time degradation, keep the length of input/output signal traces as short as possible, and route low inductance loop for the signal path and It's return path.

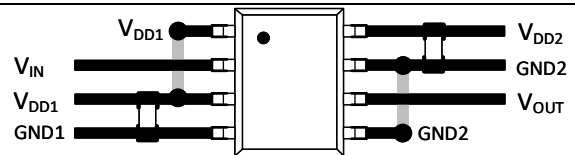


Figure 9. Recommended Printed Circuit Board Layout

JITTER MEASUREMENT

The eye diagram shown in the figure below provides the jitter measurement result for the π 110M3x. The Keysight 81160A pulse function arbitrary generator works as the data source for the π 110M3x, which generates 10Mbps pseudo random bit sequence (PRBS). The Keysight DSOS104A digital storage oscilloscope captures the π 110M3x output waveform and recovers the eye diagram with the SDA tools and eye diagram analysis tools. The result shows a typical measurement jitter data.

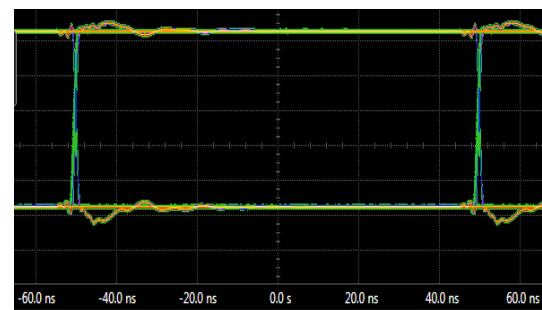


Figure 10. π 110M3x Eye Diagram

CMTI MEASUREMENT

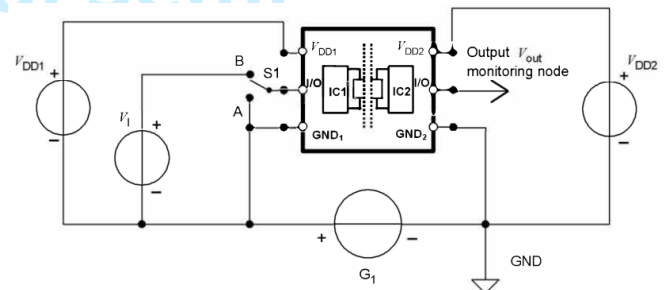


Figure 11. Common-mode transient immunity (CMTI) measurement

To measure the Common-Mode Transient Immunity (CMTI) of π 1xxxxx isolator under specified common-mode pulse magnitude (VCM) and specified slew rate of the common-mode pulse (dVCM/dt) and other specified test or ambient conditions, The common-mode pulse generator (G1) will be capable of providing fast rise and fall pulses of specified magnitude and duration of the common-mode pulse (VCM), such that the maximum common-mode slew rates (dVCM/dt) can be applied to π 1xxxxx isolator coupler under measurement. The common-mode pulse is applied between one side ground GND_1 and the other side ground GND_2 of π 1xxxxx isolator, and shall be capable of providing positive transients as well as negative transients.

OUTLINE DIMENSIONS

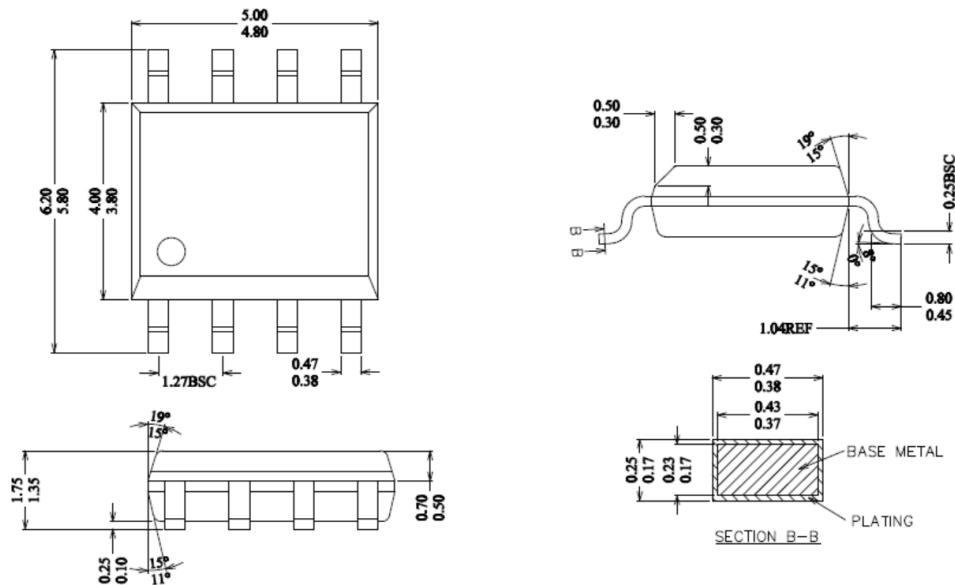


Figure 12.8-Lead Narrow Body SOIC [NB SOIC-8] Package—dimension unit(mm)

Land Patterns

8-Lead Narrow Body SOIC [NB SOIC-8]

The figure below illustrates the recommended land pattern details for the π 1xxxx in an 8-pin narrow-body SOIC. The table below lists the values for the dimensions shown in the illustration.

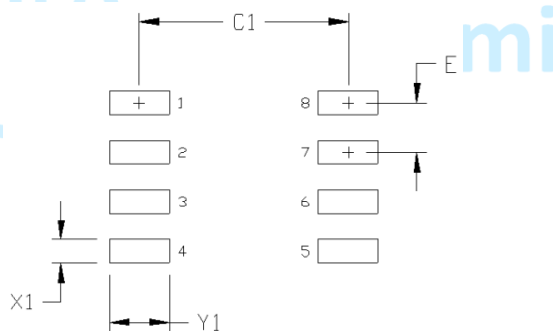


Figure 13.8-Lead Narrow Body SOIC [NB SOIC-8] Land Pattern

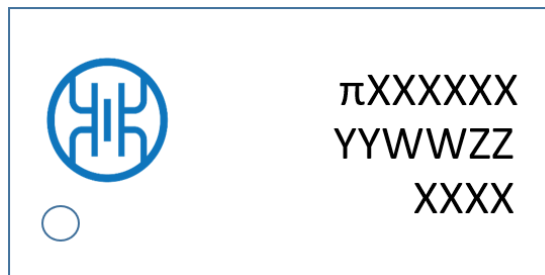
Table 13.8-Lead Narrow Body SOIC Land Pattern Dimensions

Dimension	Feature	Parameter	Unit
C1	Pad column spacing	5.40	mm
E	Pad row pitch	1.27	mm
X1	Pad width	0.60	mm
Y1	Pad length	1.55	mm

Note:

- 1.This land pattern design is based on IPC -7351.
- 2.All feature sizes shown are at maximum material condition and a card fabrication tolerance of 0.05 mm is assumed.

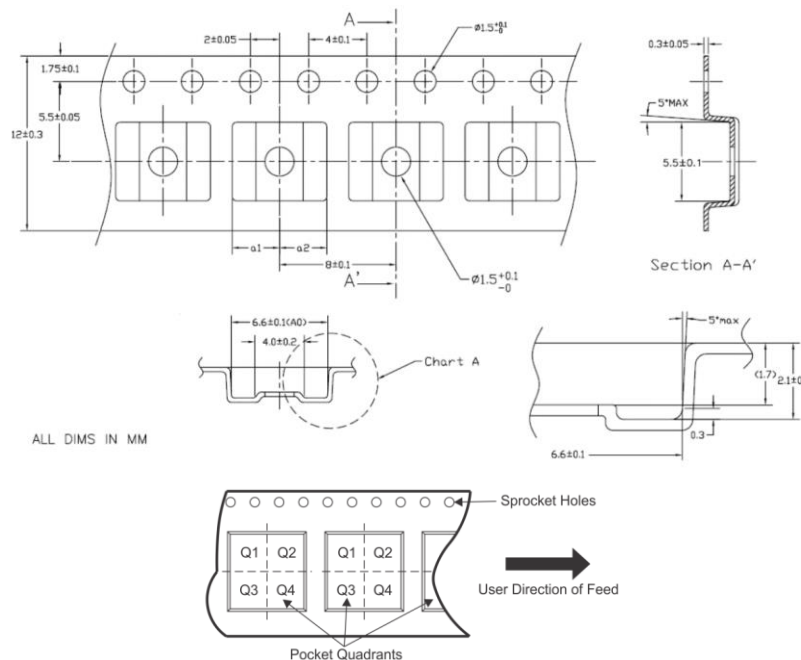
Top Marking



Line 1	Product name
Line 2	YY = Work Year WW = Work Week ZZ=Manufacturing code from assembly house
Line 3	XXXX, no special meaning

Figure 14.Top Making

REEL INFORMATION



ALL DIMS IN MM

Note: The Pin 1of the chip is in the quadrant Q1
Figure 15.NB SOIC-8 Reel Information—dimension unit(mm)

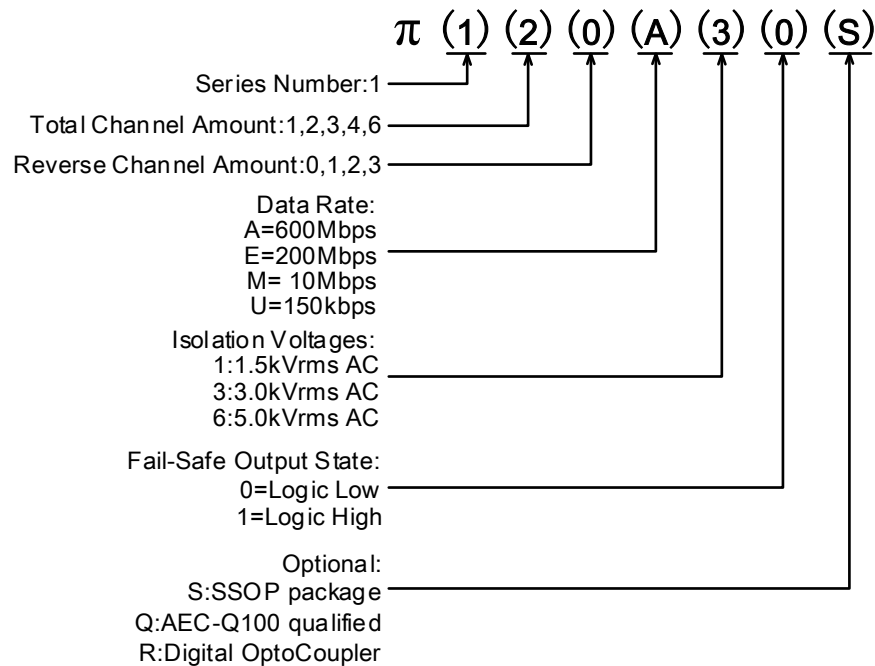
ORDERING GUIDE

Model Name ¹	Temperature Range	No. of Inputs, V _{DD1} Side	No. of Inputs, V _{DD2} Side	Isolation Rating (kV rms)	Fail-Safe Output State	Package	MSL Peak Temp ²	MOQ/ Quantity per reel ³
π 110M31	-40~125°C	1	0	3	High	NB SOIC-8	Level-3-260C-168 HR	4000
π 110M30	-40~125°C	1	0	3	Low	NB SOIC-8	Level-3-260C-168 HR	4000

Note:

- ¹ Pai1xxxx is equals to π 1xxxx in the customer BOM
- ² MSL, Peak Temp. - The Moisture Sensitivity Level rating according to the JEDEC industry standard classifications, and peak solder temperature.
- ³ MOQ, minimum ordering quantity.

PART NUMBER NAMED RULE



Notes:Pai1xxxxx is equals to π1xxxxx in the customer BOM

Figure 16. Part Number Named Rule

IMPORTANT NOTICE AND DISCLAIMER

2Pai semi intends to provide customers with the latest, accurate, and in-depth documentation. However, no responsibility is assumed by 2Pai semi for its use, nor for any infringements of patents or other rights of third parties that may result from its use. Characterization data, available modules, and "Typical" parameters provided can and do vary in different applications. Application examples described herein are for illustrative purposes only. 2Pai semi reserves the right to make changes without further notice and limitation to product information, specifications, and descriptions herein, and does not give warranties as to the accuracy or completeness of the included information. 2Pai semi shall have no liability for the consequences of use of the information supplied herein.

Trademarks and registered trademarks are the property of their respective owners. This document does not imply, or express copyright licenses granted hereunder to design or fabricate any integrated circuits.

Room 307-309, No.22, Boxia Road, Pudong New District, Shanghai, 201203, China 021-50850681

2Pai Semiconductor Co., Limited. All rights reserved.

<http://www.rpsemi.com/>

REVISION HISTORY

Revision	Date	Page	Change Record
1.0	2018/09/17	All	Initial version
1.1	2018/11/28	P11	Changed the recommended bypass capacitor value.
1.2	2019/09/08	Page1	Changed the contact address. Add <i>iDivider</i> technology description in General Description. Changed propagation delay time, CMTI and HBM ESD. Added WB SOIC-16 Lead information.
1.3	2019/12/20	Page1,11,14	Changed description of π 1xxx6x.
1.4	2020/02/16	Page1	Changed propagation delay time.
1.5	2020/02/25	Page5	Changed Pulse Width Distortion.
1.6	2020/03/16	Page6	Changed VDDx Undervoltage Threshold and Regulatory Information. Added information of Land Patterns and Top Marking
1.7	2020/04/16	Page12	Optimize description and format to make it consistent with the Chinese version.
1.8	2021/05/17	Page 11	Changed part number named rule



2Pai Semi

X-ON Electronics

Largest Supplier of Electrical and Electronic Components

Click to view similar products for 2Pai Semi manufacturer:

Other Similar products are found below :

[P142M31](#) [141M61](#) [142M61](#) [P141U31](#) [P131U31](#) [P142U31](#) [P162U31](#) [P161U31](#) [P163M31](#) [P141M30](#) [140U30](#) [P130M31](#) [P120M30](#) [120E31](#)
[P131M31](#) [P122M31](#) [P121M31](#) [P120M31](#) [P120U30](#) [P120U31](#) [P121U31](#) [P122U31](#)