

August 2014

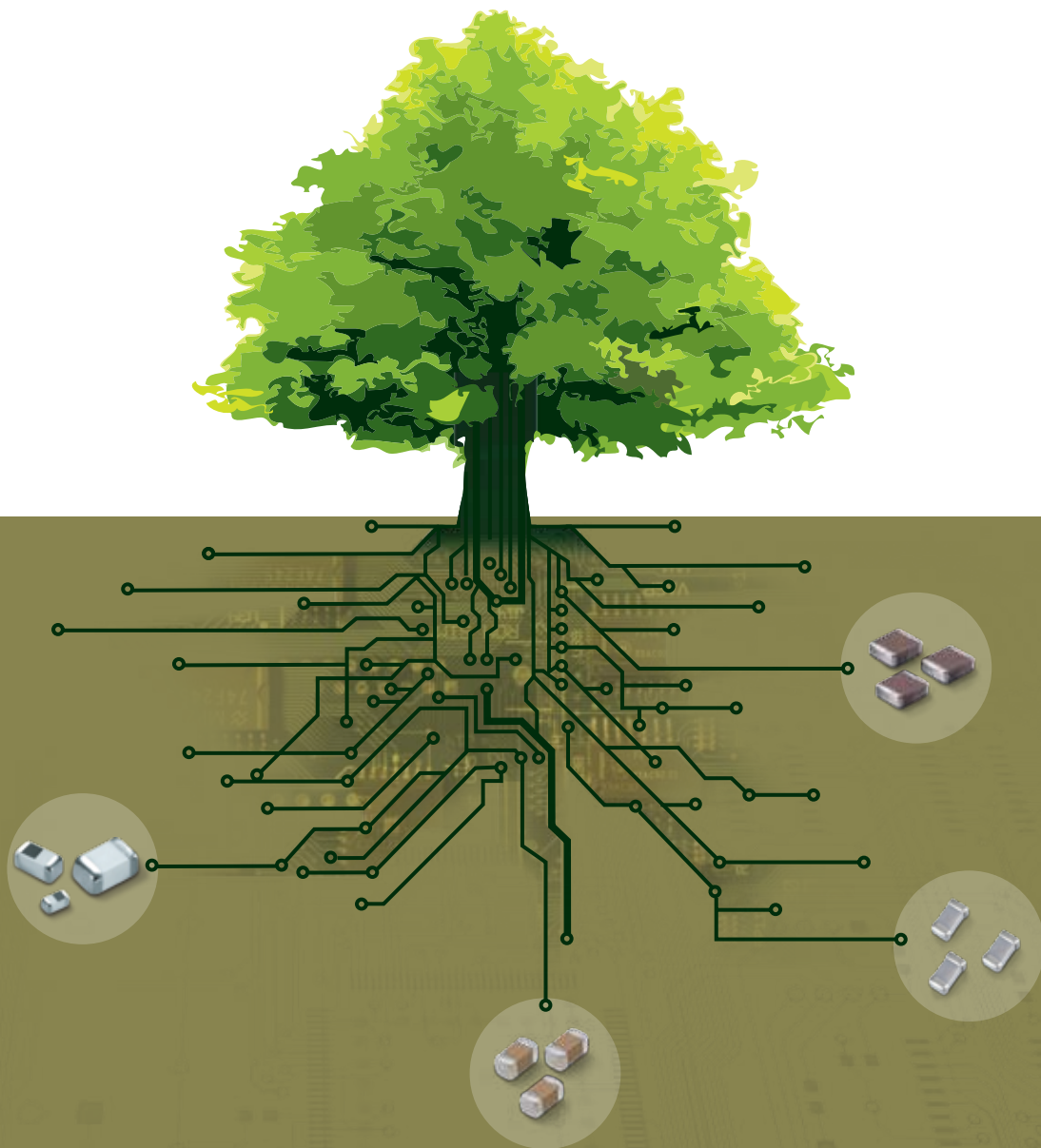

# MULTILAYER CHIP COMPONENTS



SAMSUNG  
ELECTRO-MECHANICS





## We, Samsung, declare that our component EMC is produced in accordance with EU RoHS directive.

### 1. RoHS Compliance and restriction of Br

The following restricted materials are not used in packaging materials as well as products in compliance with the law and restriction.  
- Cd, Pb, Hg, Cr6+, As, Br and the compounds, PCB, asbestos

### 2. No use of materials breaking Ozone layer

The following ODS materials are not used in our fabrication process.  
- ODS material : Freon, Haron, 1-1-1 TCE, CCl4, HCFC

If you want more detailed Information, Please Visit Samsung Electro-mechanics Website  
[<http://www.semlcr.com>]

Please, see the last page of this catalog for our environmental certification list.

# CONTENTS



<b>Product Guide</b> .....	4
<b>Chip Inductors</b>	
CIGT Series(Power Inductor) .....	7
CIG Series (Power Inductor) .....	11
CIH Series (High Frequency Inductor) .....	21
CIL Series (General Inductor) .....	33



<b>Chip Beads</b>	
CIB/CIM Series (For General) .....	41
CIC/CIS Series (For High Current) .....	58
CIV Series (For GHz Noise suppression) .....	77



<b>EMI Products</b>	
<b>Filters</b>	
Common Mode Filter .....	79
3 Terminal Capacitor .....	83



<b>Products For Communication Equipment</b>	
Diplexer .....	85
Band Pass/Low Pass Filter .....	88



<b>Appendix</b>	
Soldering Condition .....	95
Packaging .....	96

## Bead

Type	Series	Size Code mm (inch)	Impedance Range ( $\Omega$ ) at 100MHz	Effective Frequency Range				
				1MHz	10MHz	100MHz	1GHz	10GHz
General Signal  CIB:monolayer CIM:multilayer	CIB10P	1608(0603)	10~33	■	■	■		
	CIB21P	2012(0805)	11~47	■	■	■		
	CIB31P	3216(1206)	26~70	■	■	■		
	CIB32P	3225(1210)	31~60	■	■	■		
	CIB41P	4516(1806)	80~150	■	■	■		
	CIM03U	0603(0201)	80~600	■	■	■		
	CIM05U	1005(0402)	10~1000	■	■	■		
	CIM10U	1608(0603)	80~2000	■	■	■		
	CIM21U	2012(0805)	80~2000	■	■	■		
	CIM31U	3216(1206)	10~600		■	■		
High speed signal	CIB05J	1005(0402)	10			■		
	CIM03J	0603(0201)	120~240			■		
	CIM05J	1005(0402)	30~1800			■		
	CIM10J	1608(0603)	30~2500			■		
	CIM21J	2012(0805)	26~2500			■		
	CIM31J	3216(1206)	150~1500			■		
	CIM03N	0603(0201)	30~80			■		
	CIM05N	1005(0402)	75~220			■		
	CIM10N	1608(0603)	70~240			■		
	CIM21N	2012(0805)	70~240			■		
	CIM10K	1608(0603)	1500~2500			■		
	CIM21K	2012(0805)	1500~2500			■		
	CIM05F	1005(0402)	5~220			■		
	CIM10F	1608(0603)	47~470			■		
	CIM05H	1005(0402)	80~160			■		
High Current	CIC02W	0402(01005)	30~120	■	■	■		
	CIC03P	0603(0201)	30~120	■	■	■		
	CIC05P	1005(0402)	30~120	■	■	■		
	CIC10P	1608(0603)	8~600	■	■	■		
	CIC21P	2012(0805)	11~600	■	■	■		
	CIC31P	3216(1206)	30~600	■	■	■		
	CIC41P	4516(1806)	26~600	■	■	■		
	CIC05J	1005(0402)	60	■	■	■		
	CIC10J	1608(0603)	8~600	■	■	■		
	CIC21J	2012(0805)	60~600	■	■	■		
	CIC31J	3216(1206)	30~600		■	■		
		CIC41J	4516(1806)	26~600		■	■	
	CIC05Y	1005(0402)	30~120		■	■		
Ultra high current	CIS10P	1608(0603)	26~600	■	■	■		
	CIS10J~CIS41J	1608(0603)~4516(1806)	30~120	■	■	■		
	CIS21P~CIS41P	2012(0805)~4516(1806)	30~240	■	■	■		
GHz Band Noise Suppression	CIV05U	1005(0402)	600~1000	■	■	■		
	CIV05J	1005(0402)	1000~1800		■	■		

### Metal Composite Power Inductor

Type	Series	Size Code mm (inch)	Inductance(H) Range						
			1n	10n	100n	1u	10u	100u	1m
Metal Composite Thin Film Power Inductor  DC-DC Converter	CIGT201210UM	2012(0805)							0.16~1.5μH
	CIGT201608UM	2016(0806)							0.24~2.2μH
	CIGT201610UM	2016(0806)							0.24~2.2μH
	CIGT201610LM	2016(0806)							0.24~1.0μH
	CIGT252010LM	2016(0806)							0.47~1.0μH
	CIGT252012LM	2520(1008)							0.47~1.0μH

### Ferrite Multilayer Power Inductor

Type	Series	Size Code mm (inch)	Inductance(H) Range						
			1n	10n	100n	1u	10u	100u	1m
Ferrite Multilayer Power Inductor  DC-DC Converter	CIG10F(Low Profile)	1608(0603)							0.47~2.2μH
	CIG10W(Normal)	1608(0603)							0.27~4.7μH
	CIG10L(Low Rdc)	1680(0603)							2.5μH
	CIG21F(Low Profile)	2012(0805)							0.47~2.2μH
	CIG21L(Low Rdc)	2012(0805)							0.47~4.7μH
	CIG2MW	2012(0805)							0.47~4.7μH
	CIG22L(Low Rdc)	2520(1008)							0.47~10 μH
	CIG22H(High Current)	2520(1008)							0.33~4.7μH
	CIG22E(High Efficiency Type)	2520(1008)							0.47~4.7μH
	CIG21E(High Current Type)	2012(0805)							0.47~2.2μH
	CIG22B	2520(1008)							0.27~4.7μH

### Inductor

Type	Series	Size Code mm (inch)	Inductance(H) Range						
			1n	10n	100n	1u	10u	100u	1m
General Frequency range	CIL05	1005(0402)							2.2μH
	CIL10	1608(0603)							0.047~33μH
	CIL21	2012(0805)							0.047~33μH
	CIL31	3216(1206)							0.047~33μH
High Frequency range	CIH02T	0402(01005)							0.4~47nH
	CIH03T	0603(0201)							0.6~100nH
	CIH03Q	0603(0201)							0.6~100nH
	CIH03U	0603(0201)							0.6~100nH
	CIH03W	0603(0201)							0.6~22nH
	CIH05T	1005(0402)							1~100nH
	CIH05Q	1005(0402)							1~270nH
	CIH10T	1608(0603)							1~270nH



## Filters

Type	Series	Size Code mm (inch)
Common Mode Filter	CMFT080604GN	0806(0302)
	CMFT060503GN	0605(0202)
	CMFT080604HN	0806(0302)
	CMFT060503HN	0806(0302)
	CMFT040302HN	0403(0101)
	CMFT080604GE	0806(0302)
	CMFT060503GE	0605(0202)
3-Terminal capacitor	EMIC10B	1608(0603)
	EMIC21B	2012(0805)
	EMIC21F	2012(0805)
	EMIC31B	3216(1206)
Diplexer	DX21	2012(0805)
LC Filter	LCB10	1608(0603)
	LCB21	2012(0805)
	LCB22	2520(1008)

# Metal Composite Power Inductor, CIGT Series

## DC-DC converter Type

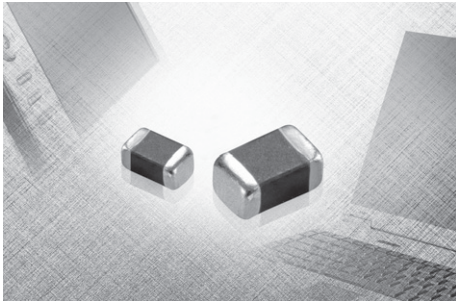

### High Current Type

- Low DC resistance
- Magnetically shielded structure
- Free of all RoHS-regulated substances
- Monolithic structure for high reliability

### Application

- Mobile phones, DSC, DVC, PDA etc. for DC- DC Converter

Operating Temp	-40~+125°C(Including self - temperature rise)
Storage Temp (After mounting)	-40~+125°C

### Dimensions

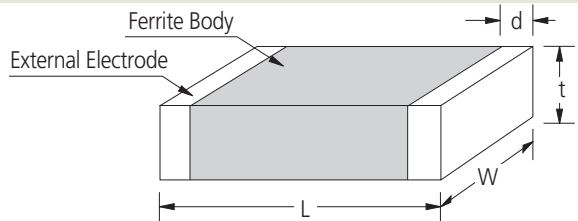

SIZE CODE	Dimension (mm)			
	L	W	t	d
CIGT201210UM	2.0±0.20	1.25±0.20	1.0 max	0.5±0.2
CIGT201608UM	2.0±0.20	1.6±0.20	0.8 max	0.5±0.2
CIGT201610UM	2.0±0.20	1.6±0.20	1.0 max	0.5±0.2
CIGT201610LM	2.0±0.20	1.6±0.20	1.0 max	0.5±0.2
CIGT252010LM	2.5±0.20	2.0±0.20	1.0 max	0.55±0.25
CIGT252012LM	2.5±0.20	2.0±0.20	1.2 max	0.55±0.25

### Part Numbering

**CIG**   **T(W)**   **2016**   **10**   **U**   **M**   **R47**   **M**   **N**   **E**  
 (1)   (2)   (3)   (4)   (5)   (6)   (7)   (8)   (9)   (10)

- (1) SEMCO Power inductor
- (2) Type - T: Thin film, W: Wire wound
- (3) Dimensions (2016: 2.0mm x 1.6mm, 2520: 2.5mm x 2.0mm)
- (4) Thickness (08: 0.8mm / 10: 1.0mm / 12: 1.2mm)
- (5) Product Series (L, U, E)
- (6) Characteristic (M: General, L: Low DCR, H: High current)
- (7) Inductance (R47: 0.47uH, 1R0: 1.0uH, 2R2: 2.2uH)
- (8) Inductance Tolerance (M: ±20%, N: ±30%)
- (9) Internal Code
- (10) Packaging Code (E: Embossed tape, C: Paper tape)



### CIGT 201210 UM Series

Part No.	Size (Inch/mm)	Thickness (mm)Max	Inductance (μH) @1MHz	DC Resistance (mΩ)		Rated Current Idc1(A) ΔL=30%		Rated Current Idc2(A) ΔL=40°C	
				Max	Typ.	Max	Typ.	Max	Typ.
CIG201210UMR16MNE	0805/2012	1.0	0.16 ± 20%	16	13	5.0	5.5	5.0	5.5
CIG201210UMR24MNE	0805/2012	1.0	0.24 ± 20%	26	21	4.0	4.5	3.3	3.7
CIG201210UMR47MNE	0805/2012	1.0	0.47 ± 20%	41	34	3.0	3.4	3.0	3.3
CIG201210UMR68MNE	0805/2012	1.0	0.68 ± 20%	58	48	2.8	3.0	2.7	2.9
CIG201210UM1R0MNE	0805/2012	1.0	1.00 ± 20%	81	67	2.0	2.4	2.0	2.3
CIG201210UM1R5MNE	0805/2012	1.0	1.50 ± 20%	139	116	1.8	1.9	1.8	1.9

- ※ Rated Current Idc1 (A) : DC current value when inductance drops by 30% of initial inductance value.
- ※ Rated Current Idc2 (A) : DC current value when the temperature of inductor rises to 40°C by self heating (Reference ambient temperature: 25°C)
- ※ Operating temperature: -40~125°C (Including self-temperature rise)
- ※ Measuring instrument  
- Inductance, Idc1 : Agilent E4991A, DC Resistance : Agilent 4338A/B

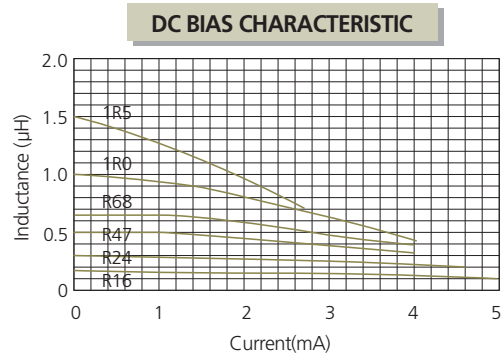
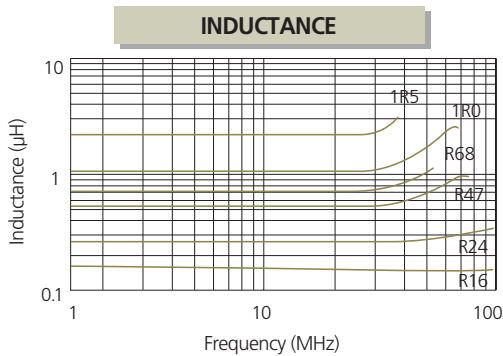

### CIGT 201608 UM Series

Part No.	Size (Inch/mm)	Thickness (mm)Max	Inductance (μH) @1MHz	DC Resistance (mΩ)		Rated Current Idc1(A) ΔL=30%		Rated Current Idc2(A) ΔL=40°C	
				Max	Typ.	Max	Typ.	Max	Typ.
CIG201608UMR24MNE	0806/2016	0.8	0.24 ± 20%	23	21	4.3	4.7	3.6	4.0
CIG201608UMR47MNE	0806/2016	0.8	0.47 ± 20%	38	35	3.3	3.6	3.0	3.4
CIG201608UM1R0MNE	0806/2016	0.8	1.00 ± 20%	57	53	3.0	3.3	2.7	3.0
CIG201608UM1R5MNE	0806/2016	0.8	1.50 ± 20%	120	100	2.1	2.3	1.9	2.1

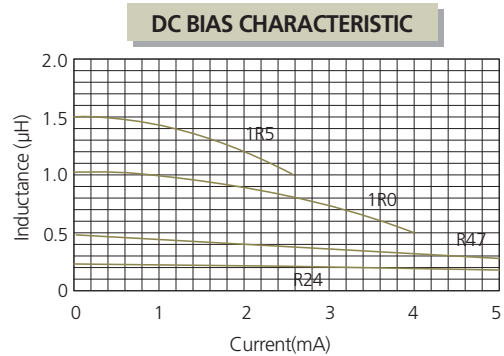
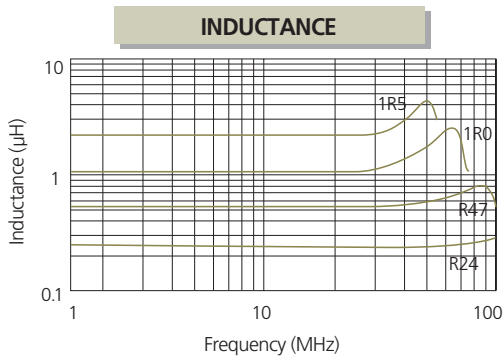



**CIGT 201610 UM Series**

Part No.	Size (Inch/mm)	Thickness (mm)Max	Inductance (μH) @1MHz	DC Resistance (mΩ)		Rated Current Idc1(A) ΔL=30%		Rated Current Idc2(A) ΔL=40°C	
				Max	Typ.	Max	Typ.	Max	Typ.
CIGT201610UMR24MNE	0806/2016	1.0	0.24 ± 20%	21	17	5.1	6.0	4.1	4.7
CIGT201610UMR47MNE	0806/2016	1.0	0.47 ± 20%	36	30	4.5	5.2	3.2	3.6
CIGT201610UMR68MNE	0806/2016	1.0	0.68 ± 20%	48	40	3.7	4.1	3.1	3.4
CIGT201610UM1R0MNE	0806/2016	1.0	1.00 ± 20%	57	48	3.1	3.5	2.8	3.1
CIGT201610UM2R2MNE	0806/2016	1.0	2.20 ± 20%	154	128	1.3	1.7	1.6	1.7

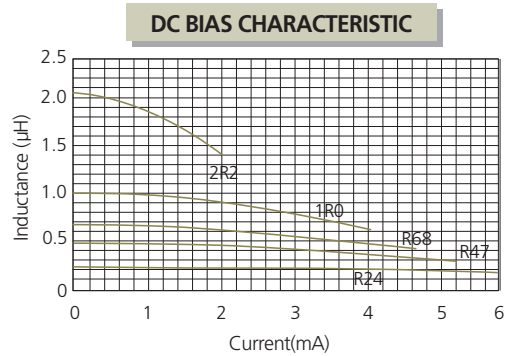
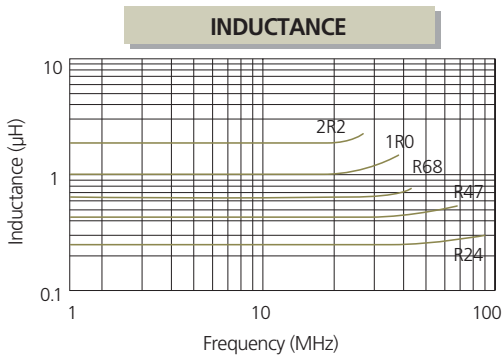

**CIGT 252010 LM Series**

Part No.	Size (Inch/mm)	Thickness (mm)Max	Inductance (μH) @1MHz	DC Resistance (mΩ)		Rated Current Idc1(A) ΔL=30%		Rated Current Idc2(A) ΔL=40°C	
				Max	Typ.	Max	Typ.	Max	Typ.
CIGT252010LMR47MN(U)E	1008/2520	1.0	0.47 ± 20%	29	24	5.0	6.0	3.7	4.1
CIGT252010LMR68MN(U)E	1008/2520	1.0	0.68 ± 20%	45	35	4.0	4.5	3.3	3.7
CIGT252010LM1R0MN(U)E	1008/2520	1.0	1.00 ± 20%	50	43	3.8	4.2	3.1	3.5

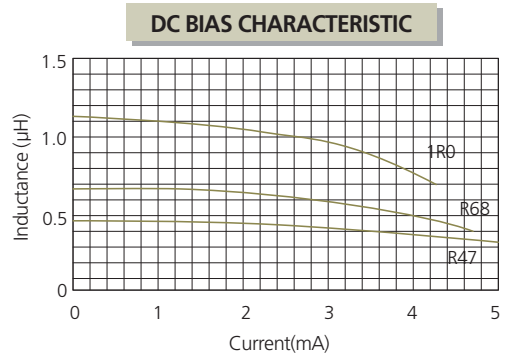
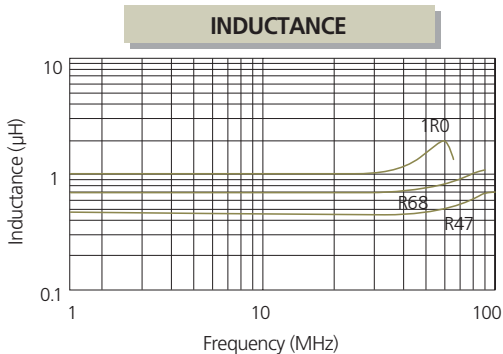

※ Rated Current Idc1 (A) : DC current value when inductance drops by 30% of initial inductance value.  
 ※ Rated Current Idc2 (A) : DC current value when the temperature of inductor rises to 40°C by self heating (Reference ambient temperature: 25°C)  
 ※ Operating temperature: -40~125°C (Including self-temperature rise)  
 ※ Measuring instrument  
 - Inductance, Idc1 : Agilent E4991A, DC Resistance : Agilent 4338A/B

### CIGT 252012 LM Series

Part No.	Size (Inch/mm)	Thickness (mm)Max	Inductance (μH) @1MHz	DC Resistance (mΩ)		Rated Current Idc1(A) ΔL=30%		Rated Current Idc2(A) ΔL=40°C	
				Max	Typ.	Max	Typ.	Max	Typ.
CIGT252012LMR47MN(U)E	1008/2520	1.2	0.47 ± 20%	25	20	5.2	6.0	4.0	4.5
CIGT252012LMR68MN(U)E	1008/2520	1.2	0.68 ± 20%	33	28	4.0	4.7	3.5	3.9
CIGT252012LM1ROMN(U)E	1008/2520	1.2	1.00 ± 20%	40	34	3.8	4.5	3.4	3.8

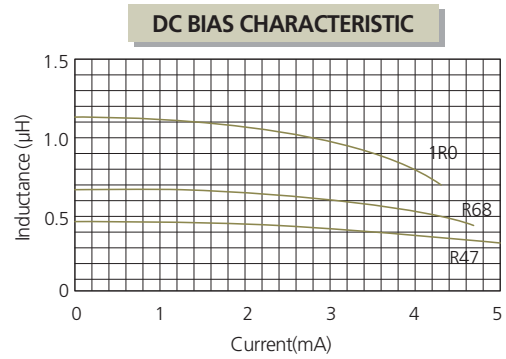
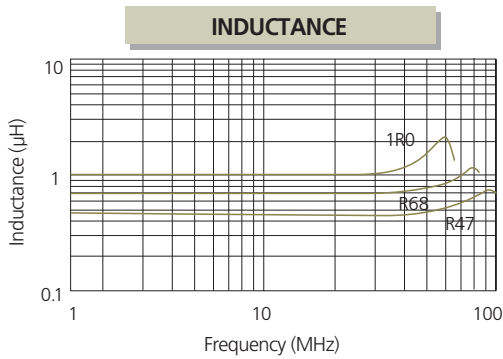

- \* Rated Current Idc1 (A) : DC current value when inductance drops by 30% of initial inductance value.
- \* Rated Current Idc2 (A) : DC current value when the temperature of inductor rises to 40°C by self heating (Reference ambient temperature: 25°C)
- \* Operating temperature: -40~125°C (Including self-temperature rise)
- \* Measuring instrument
  - Inductance, Idc1 : Agilent E4991A, DC Resistance : Agilent 4338A/B

# Power Inductor; CIG Series

## DC-DC converter Type

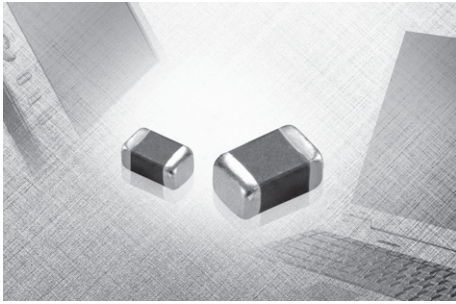

### General Features

- Low profile (1.0mm max height)
- Magnetically shielded and Low DC resistance
- Lead free termination and internal electrode
- Monolithic structure for high reliability

### Application

- Mobile phones, DSC, DVC, PDA etc. for DC- DC Converter

Operating Temp	-40~+125°C(Including self - temperature rise)
Storage Temp (After mounting)	-40~+125°C

### Dimensions

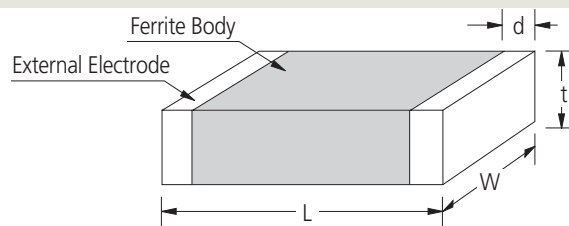

SIZE CODE	Dimension (mm)			
	L	W	t	d
CIG10F Series	1.6±0.15	0.8±0.15	0.5 max	0.3±0.2
CIG10W Series	1.6±0.15	0.8±0.15	0.8±0.15	0.3±0.2
CIG10L Series	1.6±0.10	0.8±0.10	0.65±0.1	0.5+0.2/-0.3
CIG21F Series	2.0±0.10	1.25±0.10	0.5 max	0.5+0.2/-0.3
CIG21W Series	2.0±0.20	1.25±0.20	0.9±0.1	0.5+0.2/-0.3
CIG21L Series	2.0±0.10	1.25±0.10	0.9±0.1	0.5+0.2/-0.3
CIG21C Series	2.0±0.10	1.25±0.10	0.9±0.1	0.5+0.2/-0.3
CIG2MW Series	2.0±0.15	1.6±0.15	0.9±0.1	0.5±0.2
CIG22L Series	2.5±0.20	2.0±0.20	0.9±0.1	0.55±0.25
CIG22H Series(MAE)	2.5±0.20	2.0±0.20	0.9±0.1	0.55±0.25
CIG22H Series(MNE)	2.5±0.20	2.0±0.20	1.1±0.1	0.55±0.25
CIG22E Series(MNE)	2.5±0.20	2.0±0.20	0.9±0.1	0.55±0.25
CIG22B Series(MLE)	2.5±0.15	2.0±0.15	0.9±0.1	0.60±0.20
CIG22B Series(MAE)	2.5±0.20	2.0±0.20	0.7±0.1	0.55±0.25
CIG22B Series(MNE)	2.5±0.20	2.0±0.20	0.9±0.1	0.55±0.25
CIG21E Series	2.0±0.20	1.25±0.15	0.9±0.1	0.5+0.2/-0.3
CIG32W Series	3.2±0.20	2.5±0.20	0.9±0.1	0.50±0.30
CIG32H Series	3.2±0.15	2.5±0.15	1.1±0.1	0.50±0.30

### Part Numbering

**CI**   **G**   **22**   **L**   **4R7**   **M**   **N**   **E**  
 (1)   (2)   (3)   (4)   (5)   (6)   (7)   (8)

- (1) Chip inductor
- (2) Power inductor
- (3) Dimensions (10:1608, 21:2012, 2M:2016, 22:2520,32:3225)
- (4) Product Series (W: Normal Type, L: Low Rdc Type, F: Low profile Type, C:Choke Type  
 H: High Current Type, B: High Current & Low Profile Type)  
 E : High Current Type (2012 size), High Efficiency Type (2520 size)
- (5) Inductance (R47: 0.47uH, 2R2: 2.2uH, 4R7: 4.7uH)
- (6) Tolerance (M: ± 20%, N: ± 30%)
- (7) Thickness Option (N: Standard, A: Thinner than standard, B: Thicker than standard)
- (8) Package Style (C: Paper tape / 7" reel, E: Embossed tape / 7" reel)



### CIG 1608(0603) Type - Low Profile

Part No.	Thickness(mm)	Inductance ( $\mu\text{H}$ ) @1MHz	DC Resistance ( $\Omega$ )	Rated Current (A) Max.
CIG10FR47MNC	0.5max	$0.47 \pm 20\%$	$0.20 \pm 30\%$	0.80
CIG10F1R0MNC	0.5max	$1.0 \pm 20\%$	$0.30 \pm 30\%$	0.70
CIG10F1R5MNC	0.5max	$1.5 \pm 20\%$	$0.35 \pm 30\%$	0.60
CIG10F2R2MNC	0.5max	$2.2 \pm 20\%$	$0.45 \pm 30\%$	0.50

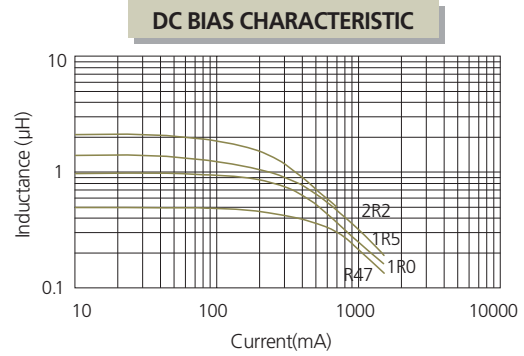
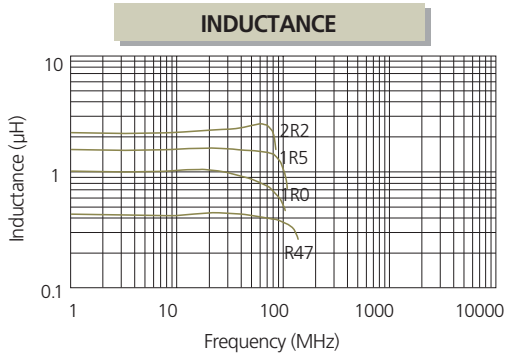

### CIG 1608(0603) Type

Part No.	Thickness(mm)	Inductance ( $\mu\text{H}$ ) @1MHz	DC Resistance ( $\Omega$ )	Rated Current (A) Max.
CIG10WR27MNC	$0.8 \pm 0.15$	$0.27 \pm 25\%$	$0.12 \pm 25\%$	1.30
CIG10WR47MNC	$0.8 \pm 0.15$	$0.47 \pm 20\%$	$0.15 \pm 20\%$	1.10
CIG10W1R0MNC	$0.8 \pm 0.15$	$1.0 \pm 20\%$	$0.20 \pm 20\%$	0.95
CIG10W1R5MNC	$0.8 \pm 0.15$	$1.5 \pm 20\%$	$0.25 \pm 20\%$	0.80
CIG10W2R2MNC	$0.8 \pm 0.15$	$2.2 \pm 20\%$	$0.30 \pm 20\%$	0.75
CIG10W3R3MNC	$0.8 \pm 0.15$	$3.3 \pm 20\%$	$0.40 \pm 20\%$	0.70
CIG10W4R7MNC	$0.8 \pm 0.15$	$4.7 \pm 20\%$	$0.50 \pm 20\%$	0.62

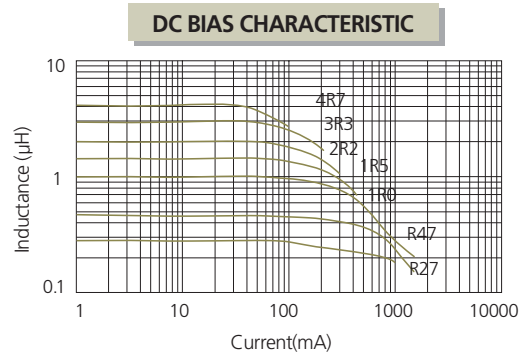
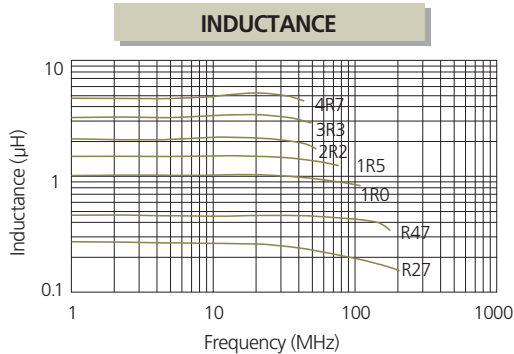

※ Rated Current: DC current value when the self-generation of heat rises to 40°C (Reference ambient temperature: 25°C)  
 ※ Test equipment: Agilent: E4991A+16092A or Equivalent

**CIG 1608(0603) Type - RDC**

Part No.	Thickness(mm)	Inductance ( $\mu\text{H}$ ) @1MHz	DC Resistance ( $\Omega$ )	Rated Current (A) Max.
CIG10L2R5NAC	0.65 $\pm$ 0.1	2.50 $\pm$ 30%	0.240 $\pm$ 25%	0.70

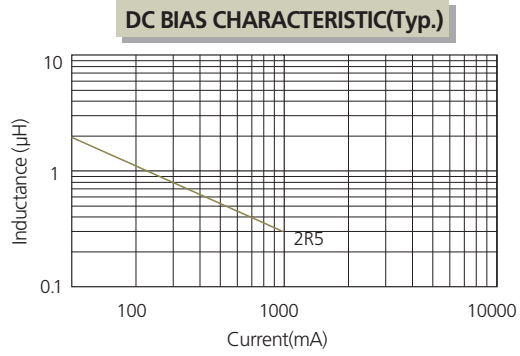
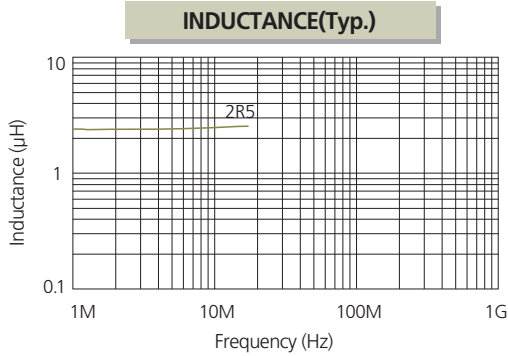

CIG Series

**CIG 2012(0805) Type - Low Profile**

Part No.	Thickness(mm)	Inductance ( $\mu\text{H}$ ) @1MHz	DC Resistance ( $\Omega$ )	Rated Current (A) Max.
CIG21FR47MNC	0.5max	0.47 $\pm$ 20%	0.12 $\pm$ 25%	1.10
CIG21F1R0MNC	0.5max	1.0 $\pm$ 20%	0.19 $\pm$ 25%	0.80
CIG21F1R5MNC	0.5max	1.5 $\pm$ 20%	0.25 $\pm$ 25%	0.70
CIG21F2R2MNC	0.5max	2.2 $\pm$ 20%	0.34 $\pm$ 25%	0.60

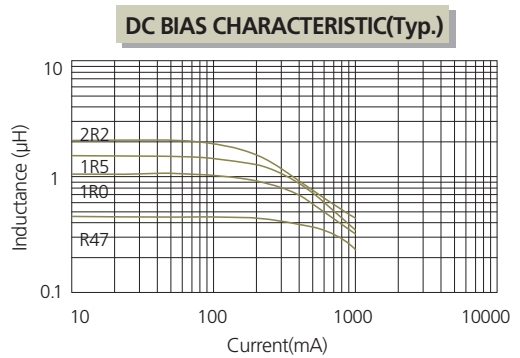
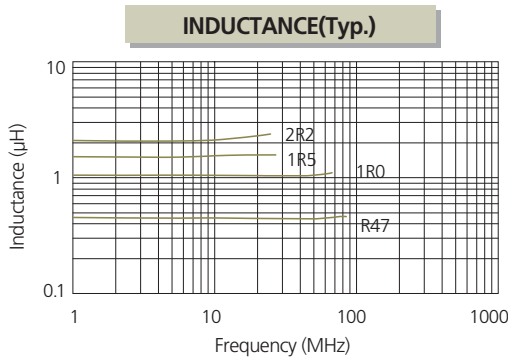

※ Rated Current: DC current value when the self-generation of heat rises to 40°C (Reference ambient temperature: 25°C)  
 ※ Test equipment: Agilent: E4991A+16092A or Equivalent



### CIG 2012(0805) Type

Part No.	Thickness(mm)	Inductance ( $\mu\text{H}$ ) @1MHz	DC Resistance ( $\Omega$ )	Rated Current (A) Max.
CIG21W1R0MNE	$0.9 \pm 0.1$	$1.0 \pm 25\%$	$0.133 \pm 20\%$	1.05
CIG21W1R5MNE	$0.9 \pm 0.1$	$1.5 \pm 25\%$	$0.150 \pm 20\%$	0.96
CIG21W2R2MNE	$0.9 \pm 0.1$	$2.2 \pm 20\%$	$0.200 \pm 20\%$	0.81
CIG21W3R3MNE	$0.9 \pm 0.1$	$3.3 \pm 20\%$	$0.250 \pm 20\%$	0.73
CIG21W4R7MNE	$0.9 \pm 0.1$	$4.7 \pm 20\%$	$0.300 \pm 20\%$	0.65

INDUCTANCE(Typ.)

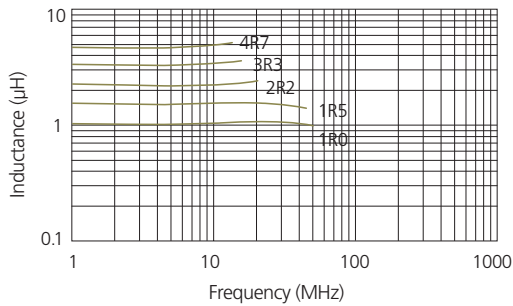

DC BIAS CHARACTERISTIC(Typ.)

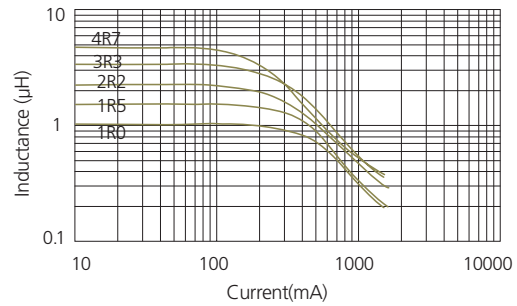

### CIG 2012(0805) Type - Low RDC

Part No.	Thickness(mm)	Inductance ( $\mu\text{H}$ ) @1MHz	DC Resistance ( $\Omega$ )	Rated Current (A) Max.
CIG21LR47MNE	$0.9 \pm 0.1$	$0.47 \pm 20\%$	$0.080 \pm 20\%$	1.30
CIG21L1R0MNE	$0.9 \pm 0.1$	$1.0 \pm 20\%$	$0.110 \pm 20\%$	1.15
CIG21L1R2MNE	$0.9 \pm 0.1$	$1.2 \pm 20\%$	$0.125 \pm 20\%$	1.10
CIG21L1R5MNE	$0.9 \pm 0.1$	$1.5 \pm 20\%$	$0.140 \pm 20\%$	1.05
CIG21L2R2MNE	$0.9 \pm 0.1$	$2.2 \pm 20\%$	$0.160 \pm 20\%$	0.95
CIG21L3R3MNE	$0.9 \pm 0.1$	$3.3 \pm 20\%$	$0.220 \pm 20\%$	0.80
CIG21L4R7MNE	$0.9 \pm 0.1$	$4.7 \pm 20\%$	$0.260 \pm 20\%$	0.75

INDUCTANCE(Typ.)

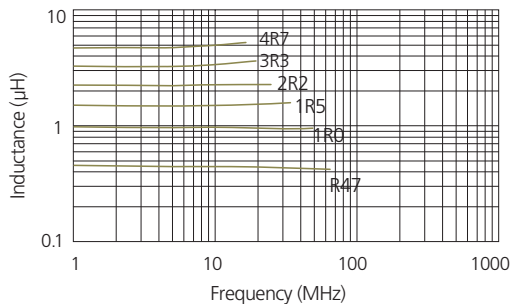

DC BIAS CHARACTERISTIC(Typ.)

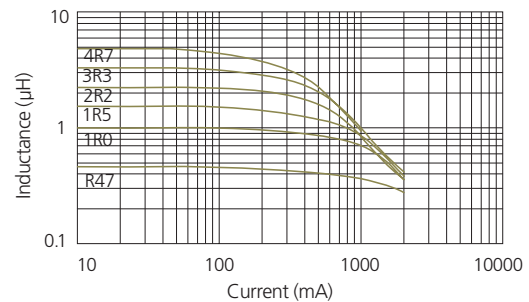

※ Rated Current: DC current value when the self-generation of heat rises to 40°C (Reference ambient temperature: 25°C)  
 ※ Test equipment: Agilent: E4991A+16092A or Equivalent

**CIG 2012(0805) Type - Choke**

Part No.	Thickness(mm)	Inductance ( $\mu\text{H}$ ) @1MHz	DC Resistance ( $\Omega$ )	Rated Current (A) Max.
CIG21C2R2MNE	$0.9 \pm 0.1$	$2.2 \pm 20\%$	$0.250 \pm 20\%$	0.80
CIG21C4R7MNE	$0.9 \pm 0.1$	$4.7 \pm 20\%$	$0.433 \pm 20\%$	0.58

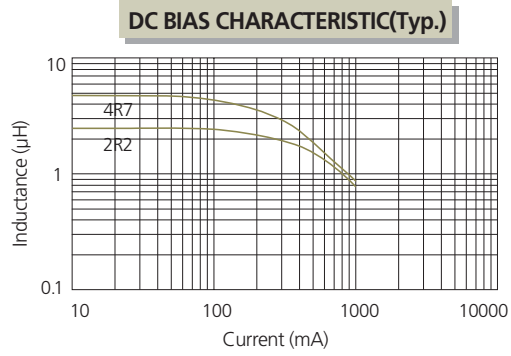
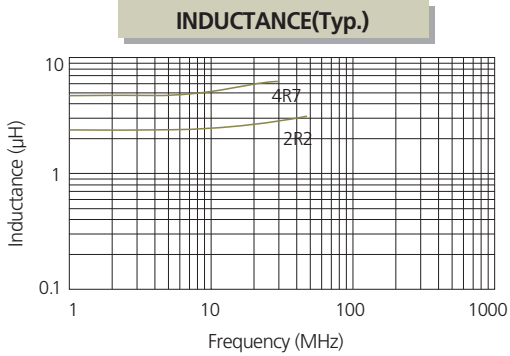

CIG Series

**CIG 2012(0805) Type - High Current**

Part No.	Thickness(mm)	Inductance ( $\mu\text{H}$ ) @1MHz	DC Resistance ( $\Omega$ )	Rated Current (A) Max.
CIG21E1R47MNE	$0.9 \pm 0.1$	$0.47 \pm 20\%$	$0.04 \pm 30\%$	2.48
CIG21E1R0MNE	$0.9 \pm 0.1$	$1.0 \pm 20\%$	$0.08 \pm 25\%$	1.7
CIG21E1R5MNE	$0.9 \pm 0.1$	$1.5 \pm 20\%$	$0.125 \pm 25\%$	1.3
CIG21E2R2MNE	$0.9 \pm 0.1$	$2.2 \pm 20\%$	$0.125 \pm 25\%$	1.3

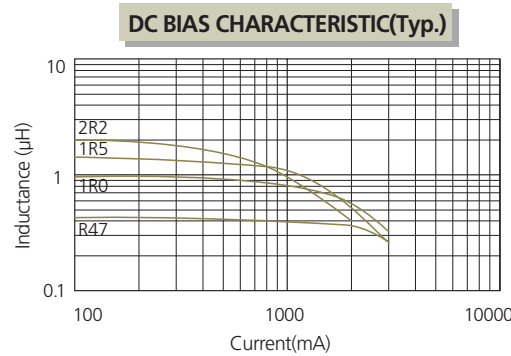
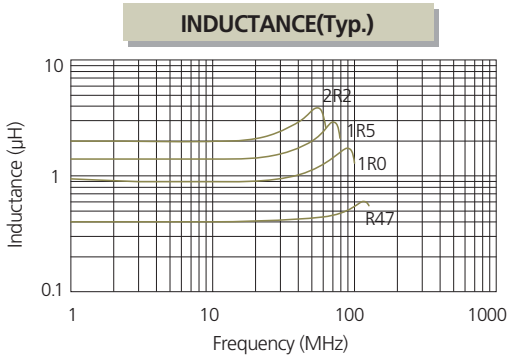

※ Rated Current: DC current value when the self-generation of heat rises to 40°C (Reference ambient temperature: 25°C)  
 ※ Test equipment: Agilent: E4991A+16092A or Equivalent



### CIG 2016 Type

Part No.	Thickness(mm)	Inductance ( $\mu\text{H}$ ) @1MHz	DC Resistance ( $\Omega$ )	Rated Current (A) Max.
CIG2MWR47NNE	$0.9 \pm 0.1$	$0.47 \pm 30\%$	$0.060 \pm 25\%$	1.6
CIG2MW1R0NNE	$0.9 \pm 0.1$	$1.0 \pm 30\%$	$0.085 \pm 25\%$	1.4
CIG2MW1R5NNE	$0.9 \pm 0.1$	$1.5 \pm 30\%$	$0.11 \pm 25\%$	1.2
CIG2MW2R2NNE	$0.9 \pm 0.1$	$2.2 \pm 30\%$	$0.11 \pm 25\%$	1.2
CIG2MW3R3NNE	$0.9 \pm 0.1$	$3.3 \pm 30\%$	$0.12 \pm 25\%$	1.2
CIG2MW4R7NNE	$0.9 \pm 0.1$	$4.7 \pm 30\%$	$0.14 \pm 25\%$	1.1

**INDUCTANCE(Typ.)**

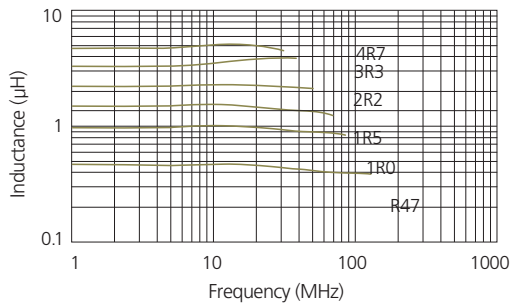

**DC BIAS CHARACTERISTIC(Typ.)**

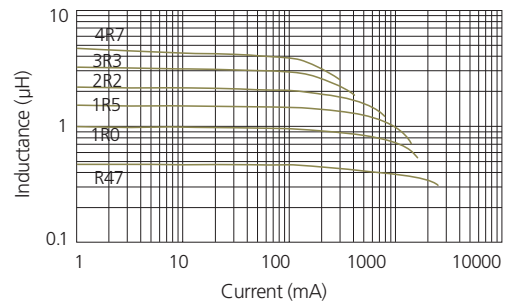

### CIG 2520(1008) Type - Low RDC

Part No.	Thickness(mm)	Inductance ( $\mu\text{H}$ ) @1MHz	DC Resistance ( $\Omega$ )	Rated Current (A) Max.
CIG22LR47MNE	$0.9 \pm 0.1$	$0.47 \pm 20\%$	$0.040 \pm 25\%$	1.8
CIG22L1R0MNE	$0.9 \pm 0.1$	$1.0 \pm 20\%$	$0.060 \pm 25\%$	1.6
CIG22L1R2MNE	$0.9 \pm 0.1$	$1.2 \pm 20\%$	$0.065 \pm 25\%$	1.5
CIG22L1R5MNE	$0.9 \pm 0.1$	$1.5 \pm 20\%$	$0.070 \pm 25\%$	1.5
CIG22L2R2MNE	$0.9 \pm 0.1$	$2.2 \pm 20\%$	$0.080 \pm 25\%$	1.3
CIG22L3R3MNE	$0.9 \pm 0.1$	$3.3 \pm 20\%$	$0.100 \pm 25\%$	1.2
CIG22L4R7MNE	$0.9 \pm 0.1$	$4.7 \pm 20\%$	$0.110 \pm 25\%$	1.1
CIG22L6R8MNE	$0.9 \pm 0.1$	$6.8 \pm 20\%$	$0.203 \pm 30\%$	0.8
CIG22L100MNE	$0.9 \pm 0.1$	$10.0 \pm 20\%$	$0.323 \pm 30\%$	0.6

**INDUCTANCE(Typ.)**

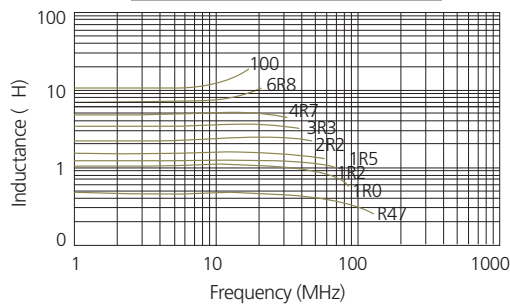

**DC BIAS CHARACTERISTIC(Typ.)**

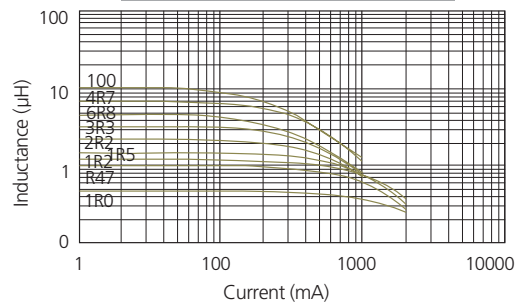



**CIG 2520(1008) Type - High Current and Low Profile**

Part No.	Thickness(mm)	Inductance (μH) @1MHz	DC Resistance (Ω)	Rated Current (A)*1 Typ.	Rated Current (A)*2	
					Typ.	Max.
CIG22BR47MAE	0.7 ± 0.1	0.47 ± 20%	0.08 ± 25%	3.0	2.4	1.6
CIG22BR56MAE	0.7 ± 0.1	0.56 ± 20%	0.10 ± 25%	2.8	2.05	1.4
CIG22B1R0MAE	0.7 ± 0.1	1.0 ± 20%	0.11 ± 25%	1.7	1.9	1.3
CIG22B2R2MAE	0.7 ± 0.1	2.2 ± 20%	0.19 ± 25%	0.85	1.65	1.1
CIG22B3R3MAE	0.7 ± 0.1	3.3 ± 20%	0.22 ± 25%	0.65	1.5	1.0
CIG22B4R7MAE	0.7 ± 0.1	4.7 ± 20%	0.28 ± 25%	0.45	1.3	0.8

CIG Series

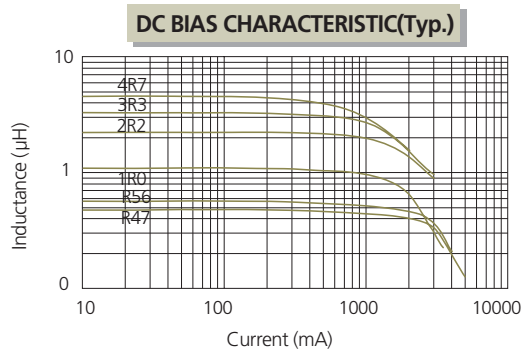
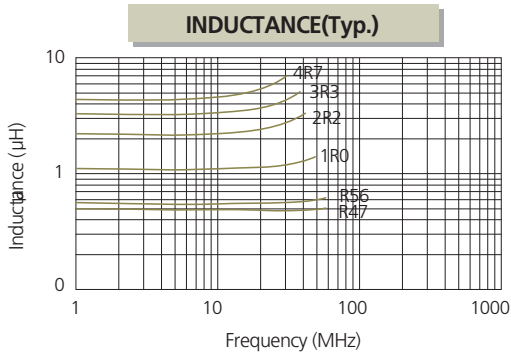

**CIG 2520(1008) Type - High Current and Low Profile(1.0t/LGA Type)**

Part No.	Thickness(mm)	Inductance (μH) @3MHz	DC Resistance (Ω)	Rated Current (A)*1 Typ.	Rated Current (A)*2
					Max.
CIG22B1R5MLE	0.9 ± 0.1	1.5 ± 20%	0.15 ± 25%	1.6	1.0
CIG22B2R2MLE	0.9 ± 0.1	2.2 ± 20%	0.17 ± 25%	1.3	0.9
CIG22B3R3MLE	0.9 ± 0.1	3.3 ± 20%	0.22 ± 25%	0.9	0.8
CIG22B4R7MLE	0.9 ± 0.1	4.7 ± 20%	0.26 ± 25%	0.7	0.7

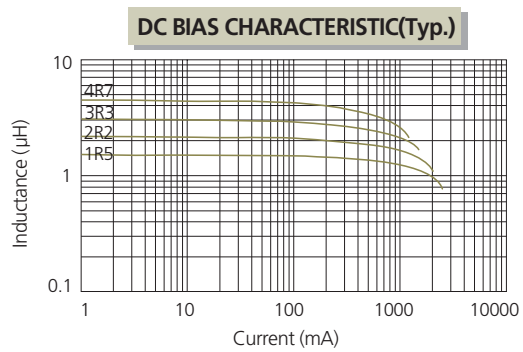
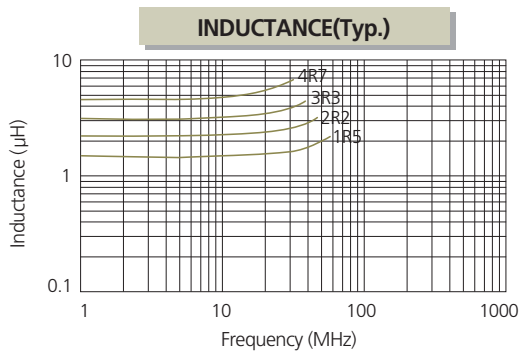

※ Rated Current (A)\*1: DC current value when Inductance drops to 30% of nominal Inductance value.  
 ※ Rated Current (A)\*2: DC current value when the self-generation of heat rises to 40°C (Reference ambient temperature: 25°C)  
 ※ Test equipment: Agilent: E4991A+16092A or Equivalent

**CIG 2520(1008) Type - High Current(1.0t)**

Part No.	Thickness(mm)	Inductance (μH) @1MHz	DC Resistance (Ω)	Rated Current (A)*1 Typ.	Rated Current (A)*2 Max.
CIG22BR27MNE	0.9±0.1	0.27±20%	0.047±30%	2.80	1.80
CIG22BR33MNE	0.9±0.1	0.33±20%	0.047±30%	2.40	1.70
CIG22BR47MNE	0.9±0.1	0.47±20%	0.0655±30%	2.40	1.60
CIG22BR56MNE	0.9±0.1	0.56±20%	0.090±30%	2.70	1.30
CIG22B1R0MNE	0.9±0.1	1.0±20%	0.125±20%	2.00	1.20
CIG22B1R5MNE	0.9±0.1	1.5±20%	0.148±20%	1.70	1.15
CIG22B2R2MNE	0.9±0.1	2.2±20%	0.183±20%	1.20	1.10
CIG22B3R3MNE	0.9±0.1	3.3±20%	0.216±20%	0.96	1.05
CIG22B4R7MNE	0.9±0.1	4.7±20%	0.250±20%	0.65	1.0

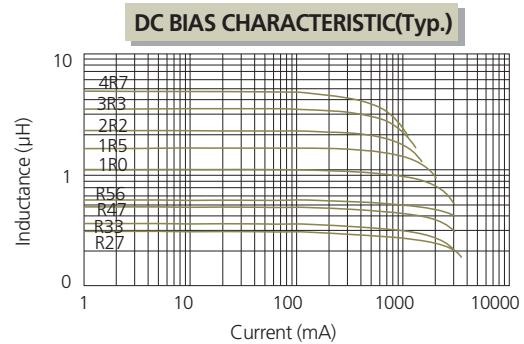
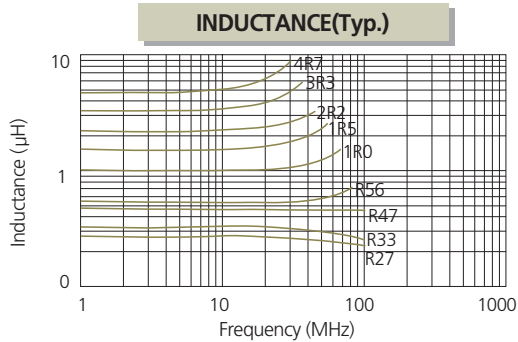
**CIG 2520(1008) Type - High Current(1.0t)**

Part No.	Thickness(mm)	Inductance (μH) @1MHz	DC Resistance (Ω)	Rated Current (A)*1 Typ.	Rated Current (A)*2 Max.
CIG22HR33MAE	0.9±0.1	0.33±20%	0.044±30%	4.80	2.2
CIG22HR47MAE	0.9±0.1	0.47±20%	0.044±30%	3.80	2.1
CIG22HR56MAE	0.9±0.1	0.56±20%	0.055±30%	3.50	2.0
CIG22H1R0MAE	0.9±0.1	1.0±20%	0.065±20%	2.00	1.8
CIG22H1R2MAE	0.9±0.1	1.2±20%	0.065±20%	1.60	1.7
CIG22H1R5MAE	0.9±0.1	1.5±20%	0.074±20%	1.30	1.5
CIG22H2R2MAE	0.9±0.1	2.2±20%	0.138±20%	1.10	1.2
CIG22H3R3MAE	0.9±0.1	3.3±20%	0.138±20%	0.85	1.1

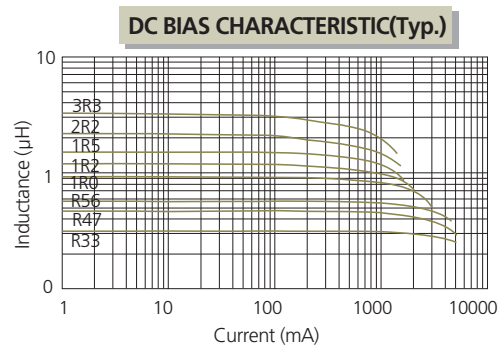
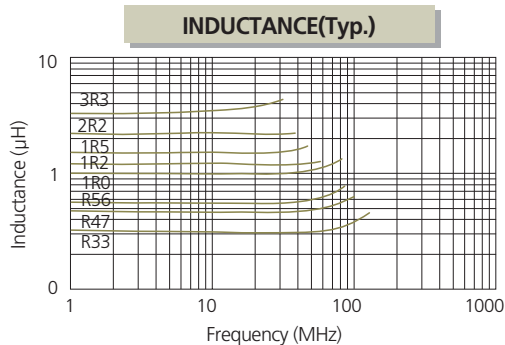

※ Rated Current (A)\*1: DC current value when Inductance drops to 30% of nominal Inductance value.  
 ※ Rated Current (A)\*2: DC current value when the self-generation of heat rises to 40°C (Reference ambient temperature: 25°C)  
 ※ Test equipment: Agilent: E4991A+16092A or Equivalent

**CIG 2520(1008) Type - High Current(1.2t)**

Part No.	Thickness(mm)	Inductance (μH) @1MHz	DC Resistance (Ω)	Rated Current (A)*1 Typ.	Rated Current (A)*2	
					Typ.	Max.
CIG22H1R0MNE	1.1±0.1	1.0±20%	0.080±25%	3.3	2.0	1.5
CIG22H1R2MNE	1.1±0.1	1.2±20%	0.094±20%	2.8	1.9	1.5
CIG22H1R5MNE	1.1±0.1	1.5±20%	0.104±20%	2.4	1.6	1.5
CIG22H2R2MNE	1.1±0.1	2.2±20%	0.116±20%	1.8	1.6	1.2
CIG22H3R3MNE	1.1±0.1	3.3±20%	0.133±20%	1.0	1.5	1.0
CIG22H4R7MNE	1.1±0.1	4.7±20%	0.233±20%	0.95	1.0	0.8

**INDUCTANCE(Typ.)**

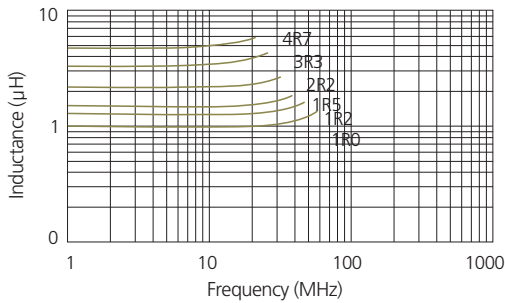

**DC BIAS CHARACTERISTIC(Typ.)**

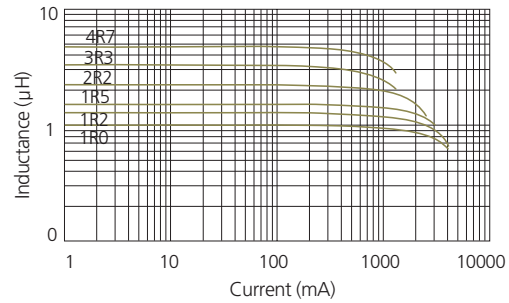

**CIG 2520(1008) Type - High Efficiency**

Part No.	Thickness(mm)	Inductance (μH) @1MHz	DC Resistance (Ω)	Rated Current (A)*1 Typ.	Rated Current (A)*2
					Max.
CIG22ER47MNE	0.9±0.1	0.47±20%	0.036±30%	3.20	3.20
CIG22E1R0MNE	0.9±0.1	1.0±20%	0.048±30%	2.20	2.30
CIG22E1R0SNE	0.9±0.1	1.0±20%	0.040±20%	2.50	2.30
CIG22E1R5MNE	0.9±0.1	1.5±20%	0.130±20%	2.40	1.50
CIG22E2R2MNE	0.9±0.1	2.2±20%	0.150±20%	1.70	1.30
CIG22E3R3MNE	0.9±0.1	3.3±20%	0.200±20%	1.10	1.10
CIG22E4R7MNE	0.9±0.1	4.7±20%	0.265±20%	0.90	1.00

**INDUCTANCE(Typ.)**

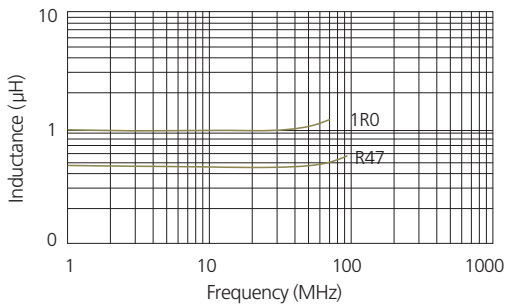

**DC BIAS CHARACTERISTIC(Typ.)**

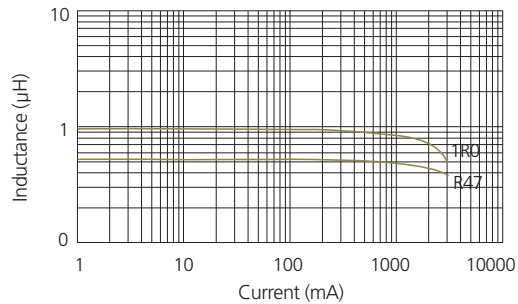

※ Rated Current (A)\*1: DC current value when Inductance drops to 30% of nominal Inductance value.  
 ※ Rated Current (A)\*2: DC current value when the self-generation of heat rises to 40°C (Reference ambient temperature: 25°C)  
 ※ Test equipment: Agilent: E4991A+16092A or Equivalent



### CIG 3225(1210) Type

Part No.	Thickness(mm)	Inductance ( $\mu\text{H}$ ) @1MHz	DC Resistance ( $\Omega$ )	Rated Current (A)*1 Typ.	Rated Current (A)*2	
					Typ.	Max.
CIG32W1R0MNE	$0.9 \pm 0.1$	$1.0 \pm 20\%$	$0.06 \pm 25\%$	2.7	2.0	1.5

INDUCTANCE(Typ.)

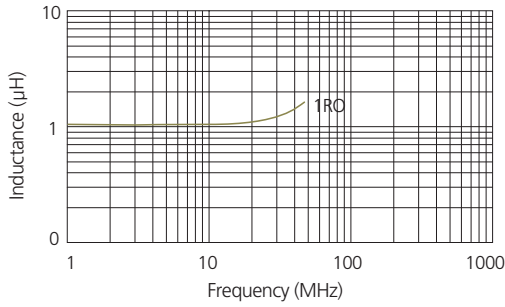

DC BIAS CHARACTERISTIC(Typ.)

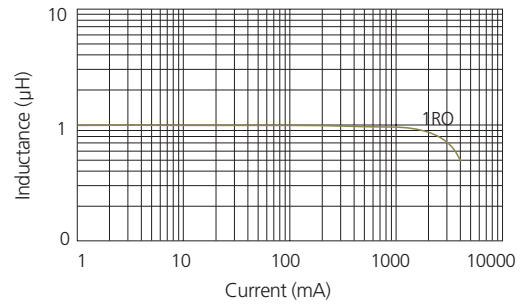

### CIG 3225(1210) Type - High Current

Part No.	Thickness(mm)	Inductance ( $\mu\text{H}$ ) @1MHz	DC Resistance ( $\Omega$ )	Rated Current (A)*1 Typ.	Rated Current (A)*2 Max.
CIG32H2R2MNE	$1.1 \pm 0.1$	$2.2 \pm 20\%$	$0.125 \pm 25\%$	2.9	1.6

INDUCTANCE(Typ.)

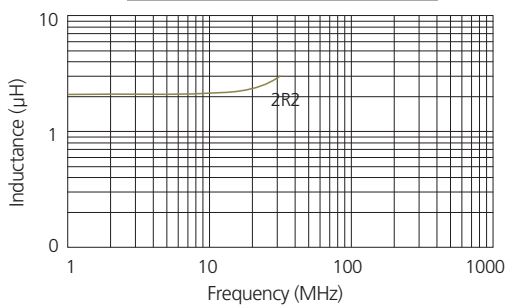

DC BIAS CHARACTERISTIC(Typ.)

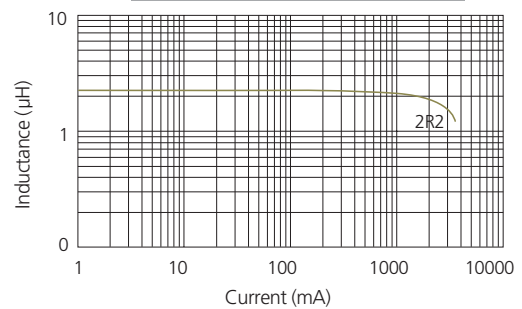

- \* Rated Current (A)\*1: DC current value when Inductance drops to 30% of nominal Inductance value.
- \* Rated Current (A)\*2: DC current value when the self-generation of heat rises to 40°C (Reference ambient temperature: 25°C)
- \* Test equipment: Agilent: E4991A+16092A or Equivalent

# Chip Inductor; CIH Series

## High Frequency Type



### Feature

- Lowest value of specific resistance, good property of Q and high SRF.
- Possible to use at range above 100MHz
- Monolithic structure for high reliability.

### Application

- Mobile communication systems, noise suppression at high frequency and Impedance matching.

CIH Series has dielectric material and 100% Ag as an internal conductor. Therefore, it has high Q and |Z| at high frequency. It is possible to use for high frequency over 100MHz.

Operating Temp	-55~+125°C
Storage Temp (After mounting)	-55~+125°C

### Dimensions

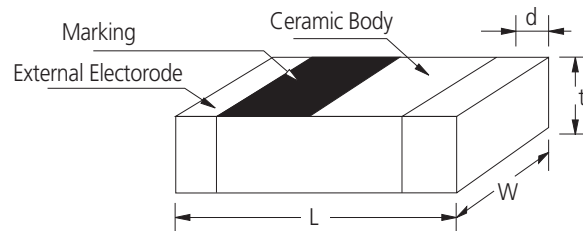

Unit : mm

SIZE CODE	L	W	t	d
02	0.4±0.02	0.2±0.02	0.2±0.02	0.1±0.04
03	0.6±0.03	0.3±0.03	0.3±0.03	0.15±0.05
03*	0.6±0.03	0.3±0.03	0.3±0.03	0.10±0.05
03**	0.6±0.03	0.3±0.03	0.3±0.03	0.07±0.04
05	1.0±0.05	0.5±0.05	0.5±0.05	0.25±0.1
10	1.6±0.15	0.8±0.15	0.8±0.15	0.3±0.2

※ \* Mark is "High-Q"

※ \*\* Mark is " Super High Q"

### Part Numbering

**CI H 03 T 12N J N C**  
 (1) (2) (3) (4) (5) (6) (7) (8)

(1) Chip Inductor

(2) H: High frequency type

(3) Dimension

(4) Material code(T : Normal, Q : High Q, U : High Q and Low Rdc, W : Super High Q, M : Mega Q)

(5) Inductance(4N7:4.7nH, 10N:10nH, R10:100nH)

(6) Tolerance(B: ±0.1nH, C: ±0.2nH, S: ±0.3nH, H: ±3%, J: ±5%,)

(7) Thickness option(N:Standard, A:Thinner than standard, B:Thicker than standard)

(8) Packaging(C: paper tape, E:embossed tape)



CIH 0402(01005) Type - Normal

Part No.	Inductance (nH)@100MHz	Q (Min.) @100 MHz	Q (typical) Frequency					SRF [MHz] min.	DC resistance ( $\Omega$ )Max.	Rated current (mA) Max.
			500MHz	800MHz	1.8GHz	2.0GHz	2.4GHz			
CIH 02T 0N2 □	0.2nH±0.1nH, 0.2nH, 0.3nH	-	11	13	23	24	27	10	0.1	350
CIH 02T 0N3 □	0.3nH±0.1nH, 0.2nH, 0.3nH	-	11	13	23	24	27	10	0.2	350
CIH 02T 0N4 □	0.4nH±0.1nH, 0.2nH, 0.3nH	-	12	14	24	25	29	10	0.2	350
CIH 02T 0N5 □	0.5nH±0.1nH, 0.2nH, 0.3nH	-	12	14	24	25	29	10	0.2	350
CIH 02T 0N6 □	0.6nH±0.1nH, 0.2nH, 0.3nH	-	12	15	26	27	31	10	0.3	320
CIH 02T 0N7 □	0.7nH±0.1nH, 0.2nH, 0.3nH	-	12	15	26	27	31	10	0.4	320
CIH 02T 0N8 □	0.8nH±0.1nH, 0.2nH, 0.3nH	-	12	14	27	27	31	10	0.4	320
CIH 02T 0N9 □	0.9nH±0.1nH, 0.2nH, 0.3nH	2	11	13	22	28	32	10	0.4	320
CIH 02T 1N0 □	1.0nH±0.1nH, 0.2nH, 0.3nH	2	11	13	22	23	27	10	0.4	250
CIH 02T 1N1 □	1.1nH±0.1nH, 0.2nH, 0.3nH	2	11	14	23	23	27	10	0.5	250
CIH 02T 1N2 □	1.2nH±0.1nH, 0.2nH, 0.3nH	2	11	14	24	24	28	10	0.5	250
CIH 02T 1N3 □	1.3nH±0.1nH, 0.2nH, 0.3nH	2	11	14	24	25	29	10	0.6	250
CIH 02T 1N4 □	1.4nH±0.1nH, 0.2nH, 0.3nH	2	10	13	22	25	29	10	0.6	250
CIH 02T 1N5 □	1.5nH±0.1nH, 0.2nH, 0.3nH	2	10	13	22	23	26	10	0.6	220
CIH 02T 1N6 □	1.6nH±0.1nH, 0.2nH, 0.3nH	2	10	13	22	23	26	10	0.6	220
CIH 02T 1N7 □	1.7nH±0.1nH, 0.2nH, 0.3nH	2	10	13	23	23	26	10	0.6	200
CIH 02T 1N8 □	1.8nH±0.1nH, 0.2nH, 0.3nH	2	11	14	23	24	27	10	0.6	200
CIH 02T 1N9 □	1.9nH±0.1nH, 0.2nH, 0.3nH	2	10	14	22	25	28	9.0	0.6	200
CIH 02T 2N0 □	2.0nH±0.1nH, 0.2nH, 0.3nH	2	10	13	21	24	26	9.0	0.6	200
CIH 02T 2N1 □	2.1nH±0.1nH, 0.2nH, 0.3nH	2	10	13	21	23	25	8.0	0.7	200
CIH 02T 2N2 □	2.2nH±0.1nH, 0.2nH, 0.3nH	2	10	13	21	23	25	8.0	0.8	200
CIH 02T 2N3 □	2.3nH±0.1nH, 0.2nH, 0.3nH	2	10	13	21	23	26	7.0	0.8	200
CIH 02T 2N4 □	2.4nH±0.1nH, 0.2nH, 0.3nH	2	10	13	21	23	25	7.0	0.8	200
CIH 02T 2N5 □	2.5nH±0.1nH, 0.2nH, 0.3nH	2	10	13	21	23	25	7.0	0.8	200
CIH 02T2N6 □	2.6nH±0.1nH, 0.2nH, 0.3nH	2	11	13	22	22	25	7.0	0.8	200
CIH 02T 2N7 □	2.7nH±0.1nH, 0.2nH, 0.3nH	2	11	13	22	23	26	7.0	0.8	200
CIH 02T 2N8 □	2.8nH±0.1nH, 0.2nH, 0.3nH	2	10	13	20	23	26	7.0	0.8	200
CIH 02T 2N9 □	2.9nH±0.1nH, 0.2nH, 0.3nH	2	10	13	20	22	24	7.0	0.8	200
CIH 02T 3N0 □	3.0nH±0.1nH, 0.2nH, 0.3nH	2	10	13	20	21	23	7.0	0.8	200
CIH 02T 3N1 □	3.1nH±0.1nH, 0.2nH, 0.3nH	2	10	13	20	21	24	7.0	0.9	200
CIH 02T 3N2 □	3.2nH±0.1nH, 0.2nH, 0.3nH	2	10	13	21	21	24	7.0	1.0	200
CIH 02T 3N3 □	3.3nH±0.1nH, 0.2nH, 0.3nH	2	10	13	21	23	25	7.0	1.1	180
CIH 02T 3N4 □	3.4nH±0.1nH, 0.2nH, 0.3nH	2	10	12	22	24	25	6.5	1.1	180
CIH 02T 3N5 □	3.5nH±0.1nH, 0.2nH, 0.3nH	2	11	13	22	24	25	6.0	1.1	180
CIH 02T 3N6 □	3.6nH±0.1nH, 0.2nH, 0.3nH	2	10	14	22	24	26	6.0	1.1	180
CIH 02T 3N7 □	3.7nH±0.1nH, 0.2nH, 0.3nH	2	10	12	20	22	25	6.0	1.1	180
CIH 02T 3N8 □	3.8nH±0.1nH, 0.2nH, 0.3nH	2	10	13	20	21	23	6.0	1.1	180
CIH 02T 3N9 □	3.9nH±0.1nH, 0.2nH, 0.3nH	2	10	12	20	22	23	6.0	1.2	180
CIH 02T 4N0 □	4.0nH±0.1nH, 0.2nH, 0.3nH	2	10	13	20	21	24	6.0	1.2	180
CIH 02T 4N3 □	4.3nH±0.3nH, 3%,5%	2	11	13	21	22	24	6.0	1.2	180
CIH 02T 4N7 □	4.7nH±0.3nH, 3%,5%	2	10	13	21	22	25	6.0	1.3	160
CIH 02T 5N1 □	5.1nH±0.3nH, 3%,5%	2	11	14	22	23	25	6.0	1.4	160
CIH 02T 5N6 □	5.6nH±0.3nH, 3%,5%	2	10	13	20	22	25	6.0	1.5	140
CIH 02T 6N2 □	6.2nH±0.3nH, 3%,5%	2	10	14	21	23	23	5.5	1.5	140
CIH 02T 6N8 □	6.8nH±3%, 5%	2	11	13	21	22	22	5.5	1.6	140
CIH 02T 7N5 □	7.5nH±3%, 5%	2	10	14	21	22	24	5.0	1.7	140
CIH 02T 8N2 □	8.2nH±3%, 5%	2	11	13	21	22	24	4.5	1.8	140
CIH 02T 9N1 □	9.1nH±3%, 5%	2	11	14	20	21	23	4.0	1.8	140
CIH 02T 10N □	10nH±3%, 5%	3	11	14	21	22	23	4.0	2.1	140
CIH 02T 12N □	12nH±3%, 5%	3	10	13	17	18	19	3.5	2.4	140
CIH 02T 15N □	15nH±3%, 5%	3	11	13	17	18	18	3.0	2.6	140
CIH 02T 18N □	18nH±3%, 5%	3	10	12	17	16	16	2.5	2.8	140
CIH 02T 22N □	22nH±3%, 5%	3	11	13	14	13	9	2.2	3	130
CIH 02T 27N □	27nH±3%, 5%	3	11	13	13	12	8	1.9	3.2	120
CIH 02T 33N □	33nH±3%, 5%	3	11	12	11	10	-	1.7	3.5	120
CIH 02T 39N □	39nH±3%, 5%	3	11	13	10	7	-	1.5	3.8	100
CIH 02T 47N □	47nH±3%, 5%	3	11	12	12	-	-	1.3	4	80

※ □: Tolerance (B: ±0.1nH, C: ±0.2nH, S: ±0.3nH, H: ±3%, J: ±5%)

※ Measurement equipment & Jig

- Impedance Measuring equipment & Jig : Agilent E4991A + 16197A Bottom Electrode SMD Test Fixture or Equivalent

- Resistance Measuring equipment & Jig : Agilent 4338B + 16089A Large Kelvin Clip Leads or Equivalent

**CIH 0603(0201) Type - Normal**

Part No.	Thickness (mm)	Inductance (nH)	Q(Min.) @100MHz	Q (typical) Frequency					SRF [MHz] min.	DC resistance (Ω)Max.	Rated current (mA) Max.
				500MHz	800MHz	1.8GHz	2.0GHz	2.4GHz			
CIH 03T 1N0 □	0.3±0.03	1.0±0.2nH,0.3nH	4	17	20	28	30	33	13000	0.14	300
CIH 03T 1N2 □	0.3±0.03	1.2±0.2nH,0.3nH	4	16	20	28	30	33	10000	0.14	250
CIH 03T 1N3 □	0.3±0.03	1.3±0.2nH,0.3nH	4	16	20	28	30	33	10000	0.14	250
CIH 03T 1N5 □	0.3±0.03	1.5±0.2nH,0.3nH	4	15	20	27	29	32	10000	0.18	230
CIH 03T 1N8 □	0.3±0.03	1.8±0.2nH,0.3nH	4	15	20	27	29	31	10000	0.19	200
CIH 03T 2N0 □	0.3±0.03	2.0±0.2nH,0.3nH	4	15	20	26	28	30	8800	0.22	200
CIH 03T 2N2 □	0.3±0.03	2.2±0.2nH,0.3nH	4	15	20	26	28	30	8800	0.22	200
CIH 03T 2N4 □	0.3±0.03	2.4±0.2nH,0.3nH	5	15	20	26	28	30	7500	0.25	200
CIH 03T 2N7 □	0.3±0.03	2.7±0.2nH,0.3nH	5	15	20	26	28	30	7700	0.25	200
CIH 03T 3N0 □	0.3±0.03	3.0±0.2nH,0.3nH	5	15	20	26	28	30	7200	0.27	200
CIH 03T 3N3 □	0.3±0.03	3.3±0.2nH,0.3nH	5	15	20	26	28	30	6700	0.30	200
CIH 03T 3N6 □	0.3±0.03	3.6±0.2nH,0.3nH	5	15	20	27	29	31	6000	0.30	200
CIH 03T 3N9 □	0.3±0.03	3.9±0.2nH,0.3nH	5	15	20	27	29	31	6000	0.30	200
CIH 03T 4N3 □	0.3±0.03	4.3±0.2nH,0.3nH	5	15	19	26	28	30	5600	0.35	200
CIH 03T 4N7 □	0.3±0.03	4.7±0.2nH,0.3nH	5	15	19	26	28	30	5300	0.40	200
CIH 03T 5N6 □	0.3±0.03	5.6±0.2nH,0.3nH	5	15	19	26	27	28	4600	0.40	200
CIH 03T 6N2 □	0.3±0.03	6.2±0.2nH,0.3nH	5	17	18	23	24	25	4100	0.48	150
CIH 03T 6N8 □	0.3±0.03	6.8±5%	5.5	14	18	23	24	25	4100	0.48	150
CIH 03T 7N5 □	0.3±0.03	7.5±5%	5	14	18	22	23	23	3700	0.51	150
CIH 03T 8N2 □	0.3±0.03	8.2±5%	5	14	18	22	23	23	3400	0.55	150
CIH 03T 10N □	0.3±0.03	10.0±5%	5	14	17	22	22	21	3300	0.63	150
CIH 03T 12N □	0.3±0.03	12.0±5%	6	14	17	21	21	19	3000	0.70	150
CIH 03T 15N □	0.3±0.03	15.0±5%	6	13	16	19	18	14	2700	0.80	100
CIH 03T 18N □	0.3±0.03	18.0±5%	6	13	17	16	14	9	2100	0.90	100
CIH 03T 22N □	0.3±0.03	22.0±5%	5	13	15	14	11	5	1800	1.20	100
CIH 03T 24N □	0.3±0.03	24.0±5%	5	13	15	12	9	3	1800	1.60	100
CIH 03T 27N □	0.3±0.03	27.0±5%	4	12	14	10	7	2	1800	1.80	50
CIH 03T 33N □	0.3±0.03	33.0±5%	4	12	14	8	5	1	1700	2.10	50
CIH 03T 39N □	0.3±0.03	39.0±5%	4	12	13	4	1	-	1500	2.40	50
CIH 03T 47N □	0.3±0.03	47.0±5%	4	11	12	2	-	-	1300	2.80	50
CIH 03T 56N □	0.3±0.03	56.0±5%	4	11	11	-	-	-	1100	3.00	50
CIH 03T 68N □	0.3±0.03	68.0±5%	5	13	11	-	-	-	1050	3.00	50
CIH 03T 82N □	0.3±0.03	82.0±5%	5	12	8	-	-	-	900	4.00	50
CIH 03T R10 □	0.3±0.03	100.0±5%	5	11	-	-	-	-	770	4.50	50

※ □ : Tolerance (C: ±0.2nH,S: ±0.3nH,H: ±3%,J: ±5%)

※ Measurement equipment & Jig : Agilent E4991A+16196C or Equivalent

CIH Series



CIH 0603(0201) Type - High Q

Part No.	Thickness (mm)	Inductance (nH)	Test Freq. [MHz]	Q (Min.) @500 MHz	Q (typical) Frequency					SRF [MHz] min.	DC resistance (Ω)Max.	Rated current (mA) Max.
					500MHz	800MHz	1.8GHz	2.0GHz	2.4GHz			
CIH 03Q 0N6 □	0.3±0.03	0.6±0.1nH,0.2nH, 0.3nH	500	13	>24	>31	>53	>56	>64	10000	0.06	600
CIH 03Q 0N7 □	0.3±0.03	0.7±0.1nH,0.2nH, 0.3nH	500	13	>24	>31	>53	>56	>64	10000	0.06	600
CIH 03Q 0N8 □	0.3±0.03	0.8±0.1nH,0.2nH, 0.3nH	500	13	>24	>31	>53	>56	>64	10000	0.07	550
CIH 03Q 0N9 □	0.3±0.03	0.9±0.1nH,0.2nH, 0.3nH	500	13	>24	>31	>53	>56	>64	10000	0.07	550
CIH 03Q 1N0 □	0.3±0.03	1.0±0.1nH,0.2nH, 0.3nH	500	13	24	31	53	56	64	10000	0.09	490
CIH 03Q 1N1 □	0.3±0.03	1.1±0.1nH,0.2nH, 0.3nH	500	13	24	31	53	56	64	10000	0.12	420
CIH 03Q 1N2 □	0.3±0.03	1.2±0.1nH,0.2nH, 0.3nH	500	13	22	27	50	55	59	10000	0.12	420
CIH 03Q 1N3 □	0.3±0.03	1.3±0.1nH,0.2nH, 0.3nH	500	13	22	27	50	55	59	10000	0.12	420
CIH 03Q 1N4 □	0.3±0.03	1.4±0.1nH,0.2nH, 0.3nH	500	13	19	24	39	41	47	10000	0.11	440
CIH 03Q 1N5 □	0.3±0.03	1.5±0.1nH,0.2nH, 0.3nH	500	13	19	24	39	41	46	10000	0.11	440
CIH 03Q 1N6 □	0.3±0.03	1.6±0.1nH,0.2nH, 0.3nH	500	13	19	24	39	41	46	10000	0.13	410
CIH 03Q 1N7 □	0.3±0.03	1.7±0.1nH,0.2nH, 0.3nH	500	13	19	24	39	41	46	10000	0.13	410
CIH 03Q 1N8 □	0.3±0.03	1.8±0.1nH,0.2nH, 0.3nH	500	13	18	24	39	41	46	10000	0.16	370
CIH 03Q 1N9 □	0.3±0.03	1.9±0.1nH,0.2nH, 0.3nH	500	13	18	23	37	41	45	10000	0.20	330
CIH 03Q 2N0 □	0.3±0.03	2.0±0.1nH,0.2nH, 0.3nH	500	13	18	23	37	41	45	10000	0.20	330
CIH 03Q 2N1 □	0.3±0.03	2.1±0.1nH,0.2nH, 0.3nH	500	13	17	23	37	39	44	10000	0.20	330
CIH 03Q 2N2 □	0.3±0.03	2.2±0.1nH,0.2nH, 0.3nH	500	13	17	23	37	39	43	10000	0.20	330
CIH 03Q 2N3 □	0.3±0.03	2.3±0.1nH,0.2nH, 0.3nH	500	13	17	23	36	38	43	10000	0.20	330
CIH 03Q 2N4 □	0.3±0.03	2.4±0.1nH,0.2nH, 0.3nH	500	13	17	22	36	38	42	10000	0.20	330
CIH 03Q 2N5 □	0.3±0.03	2.5±0.1nH,0.2nH, 0.3nH	500	13	17	22	34	35	39	9500	0.22	310
CIH 03Q 2N6 □	0.3±0.03	2.6±0.1nH,0.2nH, 0.3nH	500	13	17	22	33	35	39	9300	0.22	310
CIH 03Q 2N7 □	0.3±0.03	2.7±0.1nH,0.2nH, 0.3nH	500	13	17	22	33	35	39	9100	0.22	310
CIH 03Q 2N8 □	0.3±0.03	2.8±0.1nH,0.2nH, 0.3nH	500	13	17	22	33	35	39	8900	0.22	310
CIH 03Q 2N9 □	0.3±0.03	2.9±0.1nH,0.2nH, 0.3nH	500	13	17	22	33	35	39	8700	0.22	310
CIH 03Q 3N0 □	0.3±0.03	3.0±0.1nH,0.2nH, 0.3nH	500	13	17	22	33	39	43	8600	0.30	270
CIH 03Q 3N1 □	0.3±0.03	3.1±0.1nH,0.2nH, 0.3nH	500	13	17	22	33	39	43	8400	0.30	270
CIH 03Q 3N2 □	0.3±0.03	3.2±0.1nH,0.2nH, 0.3nH	500	13	18	22	33	35	39	8200	0.30	270
CIH 03Q 3N3 □	0.3±0.03	3.3±0.1nH,0.2nH, 0.3nH	500	13	18	22	33	35	39	8100	0.30	270
CIH 03Q 3N4 □	0.3±0.03	3.4±0.1nH,0.2nH, 0.3nH	500	13	16	22	33	35	39	8000	0.30	270
CIH 03Q 3N5 □	0.3±0.03	3.5±0.1nH,0.2nH, 0.3nH	500	13	16	22	33	35	39	7800	0.30	270
CIH 03Q 3N6 □	0.3±0.03	3.6±0.1nH,0.2nH, 0.3nH	500	13	16	22	33	35	39	7700	0.30	270
CIH 03Q 3N7 □	0.3±0.03	3.7±0.1nH,0.2nH, 0.3nH	500	13	16	22	33	35	38	7600	0.30	270
CIH 03Q 3N8 □	0.3±0.03	3.8±0.1nH,0.2nH, 0.3nH	500	13	16	22	33	35	38	7500	0.30	270
CIH 03Q 3N9 □	0.3±0.03	3.9±0.1nH,0.2nH, 0.3nH	500	13	16	22	33	35	38	7300	0.30	270
CIH 03Q 4N3 □	0.3±0.03	4.3±3%,5%, 0.3nH	500	13	16	21	32	34	37	6500	0.38	260
CIH 03Q 4N7 □	0.3±0.03	4.7±3%,5%, 0.3nH	500	13	16	21	32	34	37	6200	0.44	220
CIH 03Q 5N1 □	0.3±0.03	5.1±3%,5%, 0.3nH	500	13	16	21	32	34	37	5900	0.44	220
CIH 03Q 5N6 □	0.3±0.03	5.6±3%,5%, 0.3nH	500	13	16	21	32	34	37	5500	0.47	210
CIH 03Q 6N2 □	0.3±0.03	6.2±3%,5%, 0.3nH	500	13	16	21	32	33	36	5100	0.47	210
CIH 03Q 6N8 □	0.3±0.03	6.8±3%,5%	500	13	16	21	31	32	35	4800	0.55	190
CIH 03Q 7N5 □	0.3±0.03	7.5±3%,5%	500	13	16	20	30	32	34	4600	0.61	190
CIH 03Q 8N2 □	0.3±0.03	8.2±3%,5%	500	13	16	20	30	31	33	4300	0.57	190
CIH 03Q 9N1 □	0.3±0.03	9.1±3%,5%	500	13	16	20	30	30	32	4000	0.73	170
CIH 03Q 10N □	0.3±0.03	10.0±3%,5%	500	13	16	20	28	29	31	3800	0.73	170
CIH 03Q 12N □	0.3±0.03	12.0±3%,5%	500	12	16	20	27	27	27	3300	0.85	160
CIH 03Q 15N □	0.3±0.03	15.0±3%,5%	500	12	15	19	24	24	23	2600	0.89	150
CIH 03Q 18N □	0.3±0.03	18.0±3%,5%	500	11	15	19	23	23	21	2300	1.05	140
CIH 03Q 22N □	0.3±0.03	22.0±3%,5%	500	10	15	19	22	22	19	1900	1.29	130

※ □: Tolerance (B: ±0.1nH,C: ±0.2nH,S: ±0.3nH,H: ±3%,J: ±5%)

※ Measurement equipment & Jig

- Impedance Measuring equipment & Jig : Agilent E4991A + 16197A Bottom Electrode SMD Test Fixture or Equivalent

- Resistance Measuring equipment & Jig : Agilent 4338B + 16089A Large Kelvin Clip Leads or Equivalent



**CIH 0603(0201) Type - High Q**

Part No.	Thickness (mm)	Inductance (nH)	Test Freq. [MHz]	Q (Min.) @500 MHz	Q (typical) Frequency					SRF [MHz] min.	DC resistance (Ω)Max.	Rated current (mA) Max.
					500MHz	800MHz	1.8GHz	2.0GHz	2.4GHz			
CIH 03Q 27N □	0.3±0.03	27.0±5%	500	14	18	21	18	15	-	2200	1.9	140
CIH 03Q 33N □	0.3±0.03	33.0±5%	300	10	16	17	11	-	-	1800	2.0	140
CIH 03Q 39N □	0.3±0.03	39.0±5%	300	10	15	17	-	-	-	1800	2.1	130
CIH 03Q 47N □	0.3±0.03	47.0±5%	300	10	16	17	-	-	-	1600	2.6	120
CIH 03Q 56N □	0.3±0.03	56.0±5%	300	10	15	15	-	-	-	1400	3.3	110
CIH 03Q 68N □	0.3±0.03	68.0±5%	300	9	15	15	-	-	-	1200	3.3	110
CIH 03Q 82N □	0.3±0.03	82.0±5%	300	9	15	14	-	-	-	1200	3.8	100
CIH 03Q R10 □	0.3±0.03	100.0±5%	300	9	14	12	-	-	-	900	4.3	90

※ □: Tolerance (B: ±0.1nH, C: ±0.2nH, S: ±0.3nH, H: ±3%, J: ±5%)

※ Measurement equipment & Jig

- Impedance Measuring equipment & Jig : Agilent E4991A + 16197A Bottom Electrode SMD Test Fixture or Equivalent

- Resistance Measuring equipment & Jig : Agilent 4338B + 16089A Large Kelvin Clip Leads or Equivalent

CIH Series

**CIH 0603(0201) Type - High Q**

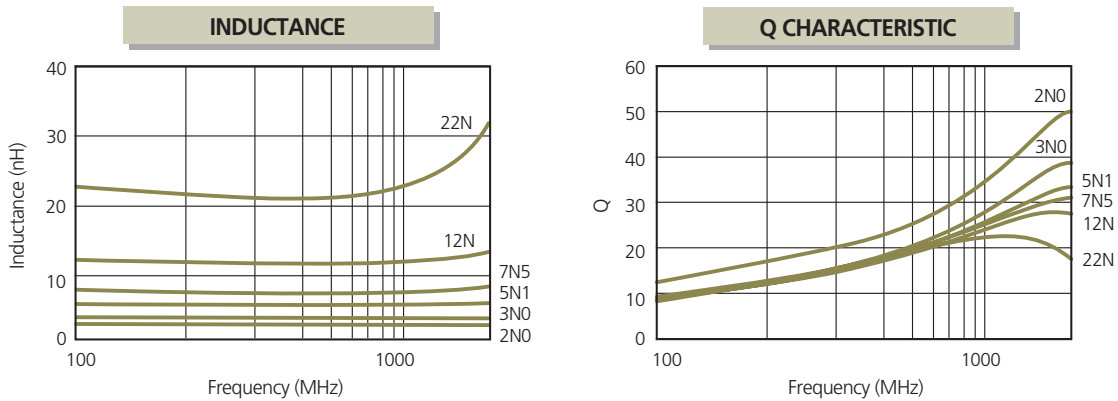



**CIH 0603(0201) Type - High Q & Low RDC**

Part No.	Thickness (mm)	Inductance (nH)	Test Freq. [MHz]	Q (Min.) @500 MHz	Q (typical) Frequency					SRF [MHz] min.	DC resistance (Ω) Max.	Rated current (mA) Max.
					500MHz	800MHz	1.8GHz	2.0GHz	2.4GHz			
CIH 03U 0N6 □	0.3±0.03	0.6±0.1nH,0.2nH, 0.3nH	500	15	>24	>31	>53	>56	>64	>10000	0.06	1000
CIH 03U 0N7 □	0.3±0.03	0.7±0.1nH,0.2nH, 0.3nH	500	15	>24	>31	>53	>56	>64	>10000	0.06	1000
CIH 03U 0N8 □	0.3±0.03	0.8±0.1nH,0.2nH, 0.3nH	500	15	>24	>31	>53	>56	>64	>10000	0.06	1000
CIH 03U 0N9 □	0.3±0.03	0.9±0.1nH,0.2nH, 0.3nH	500	15	>24	>31	>53	>56	>64	>10000	0.06	1000
CIH 03U 1N0 □	0.3±0.03	1.0±0.1nH,0.2nH, 0.3nH	500	15	24	31	53	56	64	>10000	0.07	1000
CIH 03U 1N1 □	0.3±0.03	1.1±0.1nH,0.2nH, 0.3nH	500	15	24	31	53	56	64	>10000	0.07	1000
CIH 03U 1N2 □	0.3±0.03	1.2±0.1nH,0.2nH, 0.3nH	500	15	22	27	50	55	59	>10000	0.10	800
CIH 03U 1N3 □	0.3±0.03	1.3±0.1nH,0.2nH, 0.3nH	500	15	22	27	50	55	59	>10000	0.10	800
CIH 03U1N4 □	0.3±0.03	1.4±0.1nH,0.2nH, 0.3nH	500	15	21	24	39	41	47	>10000	0.10	800
CIH 03U 1N5 □	0.3±0.03	1.5±0.1nH,0.2nH, 0.3nH	500	15	21	24	39	41	46	>10000	0.10	800
CIH 03U 1N6 □	0.3±0.03	1.6±0.1nH,0.2nH, 0.3nH	500	14	19	24	39	41	46	>10000	0.15	800
CIH 03U 1N7 □	0.3±0.03	1.7±0.1nH,0.2nH, 0.3nH	500	14	19	24	39	41	46	>10000	0.15	800
CIH 03U1N8 □	0.3±0.03	1.8±0.1nH,0.2nH, 0.3nH	500	14	18	24	39	41	46	>10000	0.15	800
CIH 03U 1N9 □	0.3±0.03	1.9±0.1nH,0.2nH, 0.3nH	500	14	18	24	37	41	45	>10000	0.15	800
CIH 03U 2N0 □	0.3±0.03	2.0±0.1nH,0.2nH, 0.3nH	500	14	19	23	37	41	45	>10000	0.15	800
CIH 03U2N1 □	0.3±0.03	2.1±0.1nH,0.2nH, 0.3nH	500	15	21	24	37	39	44	>10000	0.15	700
CIH 03U 2N2 □	0.3±0.03	2.2±0.1nH,0.2nH, 0.3nH	500	15	21	24	37	39	43	>10000	0.15	700
CIH 03U 2N3 □	0.3±0.03	2.3±0.1nH,0.2nH, 0.3nH	500	15	20	24	36	38	43	>10000	0.18	700
CIH 03U 2N4 □	0.3±0.03	2.4±0.1nH,0.2nH, 0.3nH	500	15	20	24	36	38	42	>10000	0.18	700
CIH 03U 2N5 □	0.3±0.03	2.5±0.1nH,0.2nH, 0.3nH	500	15	20	24	36	38	42	>10000	0.20	600
CIH 03U 2N6 □	0.3±0.03	2.6±0.1nH,0.2nH, 0.3nH	500	14	19	22	35	36	40	>10000	0.20	600
CIH 03U 2N7 □	0.3±0.03	2.7±0.1nH,0.2nH, 0.3nH	500	14	19	22	35	36	40	>10000	0.25	600
CIH 03U 2N8 □	0.3±0.03	2.8±0.1nH,0.2nH, 0.3nH	500	14	19	22	35	36	40	9500	0.25	600
CIH 03U 2N9 □	0.3±0.03	2.9±0.1nH,0.2nH, 0.3nH	500	14	19	22	35	36	40	9500	0.25	600
CIH 03U3N0 □	0.3±0.03	3.0±0.1nH,0.2nH, 0.3nH	500	14	19	22	35	39	43	9000	0.25	500
CIH 03U 3N1 □	0.3±0.03	3.1±0.1nH,0.2nH, 0.3nH	500	14	17	22	33	39	43	9000	0.25	500
CIH 03U 3N2 □	0.3±0.03	3.2±0.1nH,0.2nH, 0.3nH	500	14	18	22	34	35	39	9000	0.25	500
CIH 03U 3N3 □	0.3±0.03	3.3±0.1nH,0.2nH, 0.3nH	500	14	18	22	33	35	39	9000	0.25	500
CIH 03U 3N4 □	0.3±0.03	3.4±0.1nH,0.2nH, 0.3nH	500	14	18	23	34	35	39	8700	0.25	500
CIH 03U 3N5 □	0.3±0.03	3.5±0.1nH,0.2nH, 0.3nH	500	14	18	23	34	35	38	8700	0.25	500
CIH 03U 3N6 □	0.3±0.03	3.6±0.1nH,0.2nH, 0.3nH	500	14	18	23	33	35	39	8500	0.25	450
CIH 03U 3N7 □	0.3±0.03	3.7±0.1nH,0.2nH, 0.3nH	500	14	18	23	34	35	38	8500	0.25	450
CIH 03U 3N8 □	0.3±0.03	3.8±0.1nH,0.2nH, 0.3nH	500	14	18	22	33	35	38	8000	0.25	450
CIH 03U 3N9 □	0.3±0.03	3.9±0.1nH,0.2nH, 0.3nH	500	14	18	22	33	35	38	8000	0.25	450
CIH 03U 4N3 □	0.3±0.03	4.3±3%,5%, 0.3nH	500	14	18	22	32	34	37	7000	0.35	400
CIH 03U 4N7 □	0.3±0.03	4.7±3%,5%, 0.3nH	500	14	18	22	31	32	34	7000	0.35	400
CIH 03U 5N1 □	0.3±0.03	5.1±3%,5%, 0.3nH	500	14	18	22	32	34	37	6000	0.35	400
CIH 03U 5N6 □	0.3±0.03	5.6±3%,5%, 0.3nH	500	14	18	22	32	34	37	6000	0.35	400
CIH 03U 6N2 □	0.3±0.03	6.2±3%,5%, 0.3nH	500	14	18	22	32	33	36	5500	0.40	350
CIH 03U 6N8 □	0.3±0.03	6.8±3%,5%	500	14	18	22	31	32	35	5500	0.40	350
CIH 03U 7N5 □	0.3±0.03	7.5±3%,5%	500	14	18	22	30	32	34	5000	0.50	350
CIH 03U 8N2 □	0.3±0.03	8.2±3%,5%	500	14	18	22	30	31	33	5000	0.50	350
CIH 03U 9N1 □	0.3±0.03	9.1±3%,5%	500	14	18	22	30	31	32	4500	0.60	350

※ □: Tolerance (B: ±0.1nH,C: ±0.2nH,S: ±0.3nH,H: ±3%,J: ±5%)

※ Measurement equipment & Jig

- Impedance Measuring equipment & Jig : Agilent E4991A + 16197A Bottom Electrode SMD Test Fixture or Equivalent

- Resistance Measuring equipment & Jig : Agilent 4338B + 16089A Large Kelvin Clip Leads or Equivalent

**CIH 0603(0201) Type - High Q & Low RDC**

Part No.	Thickness (mm)	Inductance (nH)	Test Freq. [MHz]	Q (Min.) @500 MHz	Q (typical) Frequency					SRF [MHz] min.	DC resistance (Ω)Max.	Rated current (mA) Max.
					500MHz	800MHz	1.8GHz	2.0GHz	2.4GHz			
CIH 03U 10N □	0.3±0.03	10.0±3%,5%	500	14	18	22	28	29	31	4500	0.60	350
CIH 03U 12N □	0.3±0.03	12.0±3%,5%	500	14	18	22	28	28	27	4000	0.70	180
CIH 03U 15N □	0.3±0.03	15.0±3%,5%	500	14	18	22	27	26	24	3500	0.85	170
CIH 03U 18N □	0.3±0.03	18.0±3%,5%	500	14	18	22	25	24	21	3100	1.00	160
CIH 03U 22N □	0.3±0.03	22.0±3%,5%	500	14	18	21	22	22	19	2300	1.15	150
CIH 03U 27N □	0.3±0.03	27.0±5%	500	14	18	21	18	15	-	2200	1.90	140
CIH 03U 33N □	0.3±0.03	33.0±5%	300	10	16	17	11	-	-	1800	2.00	140
CIH 03U 39N □	0.3±0.03	39.0±5%	300	10	15	17	-	-	-	1800	2.10	130
CIH 03U 47N □	0.3±0.03	47.0±5%	300	10	16	17	-	-	-	1600	2.60	120
CIH 03U 56N □	0.3±0.03	56.0±5%	300	10	15	15	-	-	-	1400	3.30	110
CIH 03U 68N □	0.3±0.03	68.0±5%	300	9	15	15	-	-	-	1200	3.30	110
CIH 03U 82N □	0.3±0.03	82.0±5%	300	9	15	14	-	-	-	1200	3.80	100
CIH 03U R10 □	0.3±0.03	100.0±5%	300	9	14	12	-	-	-	900	4.30	90

CIH Series

**CIH0603(0201) Type -Super High Q**

Part No.	Inductance (nH)	Test Freq. [MHz]	Q (Min.) @500 MHz	Q (typical) Frequency					SRF [MHz] min.	DC resistance (Ω)Max.	Rated current (mA) Max.
				500MHz	800MHz	1.8GHz	2.0GHz	2.4GHz			
CIH03W0N6 □	0.6±0.1nH, 0.2nH, 0.3nH	500	15	>40	>45	>70	>75	>80	>20000	0.06	870
CIH03W0N7 □	0.7±0.1nH, 0.2nH, 0.3nH	500	15	>40	>45	>70	>75	>80	>20000	0.07	850
CIH03W0N8 □	0.8±0.1nH, 0.2nH, 0.3nH	500	15	>40	>45	>70	>75	>80	>18500	0.07	850
CIH03W0N9 □	0.9±0.1nH, 0.2nH, 0.3nH	500	15	>39	>45	>70	>75	>80	>18500	0.09	770
CIH03W1N0 □	1.0±0.1nH, 0.2nH, 0.3nH	500	15	>38	>45	>70	>75	>78	>17500	0.09	760
CIH03W1N1 □	1.1±0.1nH, 0.2nH, 0.3nH	500	15	>44	>45	>70	>75	>78	>17500	0.09	760
CIH03W1N2 □	1.2±0.1nH, 0.2nH, 0.3nH	500	15	42	51	76	76	79	>17500	0.09	760
CIH03W1N3 □	1.3±0.1nH, 0.2nH, 0.3nH	500	15	43	51	75	76	78	>17500	0.11	660
CIH03W1N4 □	1.4±0.1nH, 0.2nH, 0.3nH	500	15	45	55	78	81	81	>17000	0.11	660
CIH03W1N5 □	1.5±0.1nH, 0.2nH, 0.3nH	500	15	38	47	67	69	70	>16000	0.13	630
CIH03W1N6 □	1.6±0.1nH, 0.2nH, 0.3nH	500	15	38	46	67	68	69	>16000	0.13	630
CIH03W1N7 □	1.7±0.1nH, 0.2nH, 0.3nH	500	15	30	37	56	57	59	>15200	0.13	630
CIH03W1N8 □	1.8±0.1nH, 0.2nH, 0.3nH	500	15	31	39	56	58	61	>15200	0.13	610
CIH03W1N9 □	1.9±0.1nH, 0.2nH, 0.3nH	500	15	31	38	55	56	58	>12700	0.13	610
CIH03W2N0 □	2.0±0.1nH, 0.2nH, 0.3nH	500	15	31	38	56	57	59	>12700	0.13	610
CIH03W2N1 □	2.1±0.1nH, 0.2nH, 0.3nH	500	15	28	36	51	53	56	>11200	0.14	610
CIH03W2N2 □	2.2±0.1nH, 0.2nH, 0.3nH	500	15	28	34	49	51	55	>11200	0.14	610

※ □: Tolerance (B: ±0.1nH,C: ±0.2nH,S: ±0.3nH,H: ±3%,J: ±5%)

※ Measurement equipment & Jig

- Impedance Measuring equipment & Jig : Agilent E4991A + 16197A Bottom Electrode SMD Test Fixture or Equivalent

- Resistance Measuring equipment & Jig : Agilent 4338B + 16089A Large Kelvin Clip Leads or Equivalent



### CIH0603(0201) Type -Super High Q

Part No.	Inductance (nH) @100MHz	Test Freq. [MHz]	Q (Min) @100 MHz	Q (typical.)					SRF (MHz) Min.	DC resistance ( $\Omega$ ) Max.	Rated current (mA) Max.
				500MHz	800MHz	1.8GHz	2.0GHz	2.4GHz			
CIH03W2N3 □	2.3 ± 0.1nH, 0.2nH, 0.3nH	500	15	28	35	50	52	54	>10200	0.15	560
CIH03W2N4 □	2.4 ± 0.1nH, 0.2nH, 0.3nH	500	15	26	33	51	52	56	>10200	0.16	560
CIH03W2N5 □	2.5 ± 0.1nH, 0.2nH, 0.3nH	500	14	26	33	48	49	53	10200	0.16	560
CIH03W2N6 □	2.6 ± 0.1nH, 0.2nH, 0.3nH	500	14	23	31	46	48	50	10200	0.17	530
CIH03W2N7 □	2.7 ± 0.1nH, 0.2nH, 0.3nH	500	14	21	28	42	44	47	10500	0.18	530
CIH03W2N8 □	2.8 ± 0.1nH, 0.2nH, 0.3nH	500	14	24	30	42	44	47	9600	0.18	530
CIH03W2N9 □	2.9 ± 0.1nH, 0.2nH, 0.3nH	500	14	23	29	42	43	46	9600	0.19	510
CIH03W3N0 □	3.0 ± 0.1nH, 0.2nH, 0.3nH	500	14	24	31	48	49	52	9700	0.19	510
CIH03W3N1 □	3.1 ± 0.1nH, 0.2nH, 0.3nH	500	14	24	30	44	46	49	8100	0.2	500
CIH03W3N2 □	3.2 ± 0.1nH, 0.2nH, 0.3nH	500	14	24	30	43	44	47	8100	0.2	500
CIH03W3N3 □	3.3 ± 0.1nH, 0.2nH, 0.3nH	500	14	25	30	43	44	47	8500	0.23	480
CIH03W3N4 □	3.4 ± 0.1nH, 0.2nH, 0.3nH	500	14	23	29	42	43	44	7200	0.23	480
CIH03W3N5 □	3.5 ± 0.1nH, 0.2nH, 0.3nH	500	14	22	28	41	42	44	7100	0.23	480
CIH03W3N6 □	3.6 ± 0.1nH, 0.2nH, 0.3nH	500	14	22	27	40	41	42	6100	0.25	460
CIH03W3N7 □	3.7 ± 0.1nH, 0.2nH, 0.3nH	500	14	22	27	39	40	42	6000	0.25	460
CIH03W3N8 □	3.8 ± 0.1nH, 0.2nH, 0.3nH	500	14	22	27	38	39	40	6100	0.25	460
CIH03W3N9 □	3.9 ± 0.1nH, 0.2nH, 0.3nH	500	14	22	28	40	41	43	5800	0.25	440
CIH03W4N3 □	4.3 ± 3%, 5%, 0.2nH, 0.3nH	500	14	21	26	37	38	39	5300	0.3	400
CIH03W4N7 □	4.7 ± 3%, 5%, 0.2nH, 0.3nH	500	14	22	27	40	41	41	4500	0.3	400
CIH03W5N1 □	5.1 ± 3%, 5%, 0.2nH, 0.3nH	500	14	20	26	34	35	36	4200	0.35	370
CIH03W5N6 □	5.6 ± 3%, 5%, 0.2nH, 0.3nH	500	14	20	24	35	35	36	4100	0.35	370
CIH03W6N2 □	6.2 ± 3%, 5%, 0.2nH, 0.3nH	500	14	20	24	33	34	35	4000	0.55	320
CIH03W6N8 □	6.8 ± 3%, 5%	500	14	20	25	36	37	37	3900	0.55	320
CIH03W7N5 □	7.5 ± 3%, 5%	500	14	19	24	34	35	36	3800	0.6	300
CIH03W8N2 □	8.2 ± 3%, 5%	500	14	19	24	33	34	34	3700	0.65	250
CIH03W9N1 □	9.1 ± 3%, 5%	500	14	19	24	32	32	31	3300	0.7	250
CIH03W10N □	10.0 ± 3%, 5%	500	14	18	23	31	31	30	3250	0.85	220
CIH03W12N □	12.0 ± 3%, 5%	500	14	18	22	30	30	28	3000	0.85	220
CIH03W15N □	15.0 ± 3%, 5%	500	14	18	22	28	29	26	2900	1	200
CIH03W18N □	18.0 ± 3%, 5%	500	14	18	23	23	21	16	2300	1.1	180
CIH03W22N □	22.0 ± 3%, 5%	500	14	17	21	25	22	18	2300	1.6	160

※ □: Tolerance (B: ±0.1nH, C: ±0.2nH, S: ±0.3nH, H: ±3%, J: ±5%)

※ Measurement equipment & Jig

- Impedance Measuring equipment & Jig : Agilent E4991A + 16197A Bottom Electrode SMD Test Fixture or Equivalent

- Resistance Measuring equipment & Jig : Agilent 4338B + 16089A Large Kelvin Clip Leads or Equivalent

CIH0603(0201) Type -Super High Q

INDUCTANCE

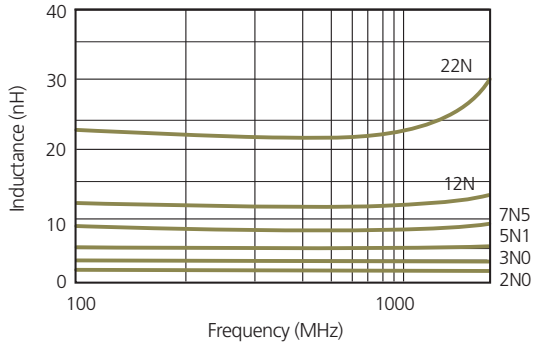

Q CHARACTERISTIC

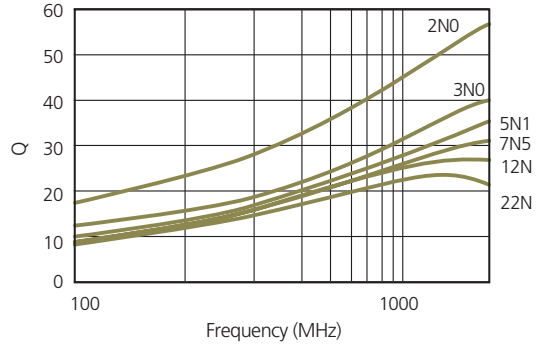

CIH  
Series



CIH 1005(0402) Type

Part No.	Thickness (mm)	Inductance (nH) @100MHz	Q (Min) @100 MHz	Q (typical.)					SRF (MHz) Min.	DC resistance ( $\Omega$ ) Max.	Rated current (mA) Max.
				500MHz	800MHz	1.8GHz	2.0GHz	2.4GHz			
CIH 05T 1N0 □	0.5±0.05	1.0±0.2nH,0.3nH	8	23	29	48	50	56	10000	0.12	300
CIH 05T 1N2 □	0.5±0.05	1.2±0.2nH,0.3nH	8	23	29	48	50	56	10000	0.12	300
CIH 05T 1N5 □	0.5±0.05	1.5±0.2nH,0.3nH	8	23	29	47	50	56	6000	0.13	300
CIH 05T 1N8 □	0.5±0.05	1.8±0.2nH,0.3nH	8	20	26	41	43	49	6000	0.14	300
CIH 05T 2N0 □	0.5±0.05	2.0±0.2nH,0.3nH	8	22	27	44	47	52	6000	0.16	300
CIH 05T 2N2 □	0.5±0.05	2.2±0.2nH,0.3nH	8	22	27	44	47	52	6000	0.16	300
CIH 05T 2N4 □	0.5±0.05	2.4±0.2nH,0.3nH	8	22	27	44	47	52	6000	0.16	300
CIH 05T 2N7 □	0.5±0.05	2.7±0.2nH,0.3nH	8	22	27	43	45	50	6000	0.17	300
CIH 05T 3N0 □	0.5±0.05	3.0±0.2nH,0.3nH	8	24	30	46	48	53	6000	0.19	300
CIH 05T 3N3 □	0.5±0.05	3.3±0.2nH,0.3nH	8	24	30	46	48	53	6000	0.19	300
CIH 05T 3N6 □	0.5±0.05	3.6±0.2nH,0.3nH	8	24	30	46	48	53	6000	0.19	300
CIH 05T 3N9 □	0.5±0.05	3.9±0.2nH,0.3nH	8	22	28	43	45	50	4000	0.22	300
CIH 05T 4N3 □	0.5±0.05	4.3±0.2nH,0.3nH	8	22	28	43	45	50	4000	0.24	300
CIH 05T 4N7 □	0.5±0.05	4.7±0.2nH,0.3nH	8	23	30	45	47	50	4000	0.24	300
CIH 05T 5N1 □	0.5±0.05	5.1±0.2nH,0.3nH	8	22	28	42	43	45	4000	0.27	300
CIH 05T 5N6 □	0.5±0.05	5.6±0.2nH,0.3nH	8	22	28	42	43	45	4000	0.27	300
CIH 05T 6N2 □	0.5±0.05	6.2±0.2nH,0.3nH	8	22	28	40	41	41	3900	0.32	300
CIH 05T 6N8 □	0.5±0.05	6.8±5%, 10%	8	22	28	40	41	41	3900	0.32	300
CIH 05T 7N5 □	0.5±0.05	7.5±5%, 10%	8	22	28	38	38	36	3600	0.37	300
CIH 05T 8N2 □	0.5±0.05	8.2±5%, 10%	8	22	28	38	38	36	3600	0.37	300
CIH 05T 9N1 □	0.5±0.05	9.1±5%, 10%	8	22	28	37	36	31	3200	0.42	300
CIH 05T 10N □	0.5±0.05	10.0±5%, 10%	8	22	28	37	36	31	3200	0.42	300
CIH 05T 12N □	0.5±0.05	12.0±5%, 10%	8	22	28	33	31	23	2700	0.50	300
CIH 05T 15N □	0.5±0.05	15.0±5%, 10%	8	22	28	29	26	17	2300	0.55	300
CIH 05T 18N □	0.5±0.05	18.0±5%, 10%	8	23	28	26	22	11	2100	0.65	250
CIH 05T 22N □	0.5±0.05	22.0±5%, 10%	8	22	27	21	14	2	1900	0.80	250
CIH 05T 27N □	0.5±0.05	27.0±5%, 10%	8	20	23	10	3	-	1600	0.90	250
CIH 05T 33N □	0.5±0.05	33.0±5%, 10%	8	20	23	3	-	-	1300	1.00	250
CIH 05T 39N □	0.5±0.05	39.0±5%, 10%	8	20	21	-	-	-	1200	1.20	200
CIH 05T 47N □	0.5±0.05	47.0±5%, 10%	8	19	20	-	-	-	1000	1.30	200
CIH 05T 56N □	0.5±0.05	56.0±5%, 10%	8	19	18	-	-	-	750	1.40	180
CIH 05T 68N □	0.5±0.05	68.0±5%, 10%	8	17	15	-	-	-	750	1.40	180
CIH 05T 82N □	0.5±0.05	82.0±5%, 10%	8	16	11	-	-	-	600	1.60	150
CIH 05T R10 □	0.5±0.05	100.0±5%, 10%	8	15	9	-	-	-	600	1.60	130

※ □: Tolerance (C:±0.2nH,S:±0.3nH,J:±5%,K±10%)

※ Measurement equipment & Jig : Agilent E4991A+16192A or Equivalent

**CIH 1005(0402) High Q Type**

Part No.	Thickness (mm)	Inductance (nH) @100MHz	Q (Min) @100 MHz	Q (typical.)					SRF (MHz) Min.	DC resistance (Ω) Max.	Rated current (mA) Max.
				500MHz	800MHz	1.8GHz	2.0GHz	2.4GHz			
CIH05Q1N0 □	0.5±0.05	1.0nH±0.3nH	8	23	34	51	54	57	10000	0.07	1000
CIH05Q1N2 □	0.5±0.05	1.2nH±0.3nH	8	23	36	56	58	60	6000	0.09	1000
CIH05Q1N5 □	0.5±0.05	1.5nH±0.3nH	8	23	34	50	53	55	6000	0.10	1000
CIH05Q1N8 □	0.5±0.05	1.8nH±0.3nH	8	20	33	48	49	50	6000	0.10	900
CIH05Q2N2 □	0.5±0.05	2.2nH±0.3nH	8	22	34	48	49	50	6000	0.12	900
CIH05Q2N4 □	0.5±0.05	2.4nH±0.3nH	8	22	34	51	52	52	6000	0.15	800
CIH05Q2N7 □	0.5±0.05	2.7nH±0.3nH	8	22	33	49	50	50	6000	0.15	800
CIH05Q3N0 □	0.5±0.05	3.0nH±0.3nH	8	24	34	49	51	50	6000	0.17	800
CIH05Q3N3 □	0.5±0.05	3.3nH±0.3nH	8	24	33	46	47	46	6000	0.17	800
CIH05Q3N6 □	0.5±0.05	3.6nH±0.3nH	8	24	33	45	47	46	6000	0.18	700
CIH05Q3N9 □	0.5±0.05	3.9nH±0.3nH	8	22	33	49	47	46	6000	0.18	700
CIH05Q4N3 □	0.5±0.05	4.3nH±0.3nH	8	22	33	44	45	44	6000	0.18	700
CIH05Q4N7 □	0.5±0.05	4.7nH±0.3nH	8	23	33	42	43	42	6000	0.18	700
CIH05Q5N1 □	0.5±0.05	5.1nH±0.3nH	8	22	33	44	45	42	5300	0.20	600
CIH05Q5N6 □	0.5±0.05	5.6nH±0.3nH	8	22	32	41	40	38	4500	0.20	600
CIH05Q6N2 □	0.5±0.05	6.2nH±0.3nH	8	22	31	41	41	38	4500	0.22	600
CIH05Q6N8 □	0.5±0.05	6.8nH±5%	8	22	30	40	40	37	4500	0.24	600
CIH05Q7N5 □	0.5±0.05	7.5nH±5%	8	22	29	38	37	34	4200	0.24	500
CIH05Q8N2 □	0.5±0.05	8.2nH±5%	8	22	29	35	34	29	3700	0.24	500
CIH05Q9N1 □	0.5±0.05	9.1nH±5%	8	22	29	36	35	31	3400	0.26	500
CIH05Q10N □	0.5±0.05	10nH±5%	8	22	29	35	33	28	3400	0.28	500
CIH05Q12N □	0.5±0.05	12nH±5%	8	22	27	28	24	18	3000	0.30	400
CIH05Q15N □	0.5±0.05	15nH±5%	8	22	27	25	21	13	2500	0.40	400
CIH05Q18N □	0.5±0.05	18nH±5%	8	23	25	22	18	-	2200	0.42	350
CIH05Q22N □	0.5±0.05	22nH±5%	8	22	24	16	-	-	1900	0.45	350
CIH05Q27N □	0.5±0.05	27nH±5%	8	20	21	-	-	-	1700	0.48	300
CIH05Q33N □	0.5±0.05	33nH±5%	8	20	20	-	-	-	1600	0.58	300
CIH05Q39N □	0.5±0.05	39nH±5%	8	20	18	-	-	-	1200	0.65	250
CIH05Q47N □	0.5±0.05	47nH±5%	8	19	16	-	-	-	1000	0.78	250
CIH05Q56N □	0.5±0.05	56nH±5%	8	19	13	-	-	-	800	0.82	200
CIH05Q68N □	0.5±0.05	68nH±5%	8	17	10	-	-	-	800	0.92	200
CIH05Q82N □	0.5±0.05	82nH±5%	8	16	6	-	-	-	700	1.20	200
CIH05Q91N □	0.5±0.05	91nH ±5%	8	-	-	-	-	-	600	1.32	200
CIH05QR10 □	0.5±0.05	100nH±5%	8	-	-	-	-	-	600	1.35	200
CIH05QR12 □	0.5±0.05	120nH±5%	8	-	-	-	-	-	600	2.00	150
CIH05QR15 □	0.5±0.05	150nH±5%	8	-	-	-	-	-	550	2.99	150
CIH05QR18 □	0.5±0.05	180nH±5%	8	-	-	-	-	-	500	3.38	150
CIH05QR22 □	0.5±0.05	220nH±5%	8	-	-	-	-	-	450	3.77	120
CIH05QR27 □	0.5±0.05	270nH±5%	8	-	-	-	-	-	400	4.94	110

CIH Series



### CIH 1608(0603) Type

Part No.	Thickness (mm)	Inductance (nH) @100MHz	Q (typical)		SRF (MHz) Min.	DC resistance (Ω) Max.	Rated current (mA) Max.
			100MHz	800MHz			
CIH 10T 1N0 □	0.8±0.15	1.0±0.3nH	8	20	10000	0.05	800
CIH 10T 1N2 □	0.8±0.15	1.2±0.3nH	8	20	10000	0.05	800
CIH 10T 1N5 □	0.8±0.15	1.5±0.3nH	8	20	6000	0.10	800
CIH 10T 1N8 □	0.8±0.15	1.8±0.3nH	8	20	6000	0.10	800
CIH 10T 2N2 □	0.8±0.15	2.2±0.3nH	8	20	6000	0.10	800
CIH 10T 2N7 □	0.8±0.15	2.7±0.3nH	10	25	6000	0.10	800
CIH 10T 3N3 □	0.8±0.15	3.3±0.3nH, 10%	10	25	6000	0.12	800
CIH 10T 3N9 □	0.8±0.15	3.9±0.3nH, 10%	10	27	6000	0.14	800
CIH 10T 4N7 □	0.8±0.15	4.7±0.3nH, 10%	10	27	4000	0.16	800
CIH 10T 5N6 □	0.8±0.15	5.6±0.3nH, 10%	10	27	4000	0.18	800
CIH 10T 6N8 □	0.8±0.15	6.8±10%, 5%	10	27	4000	0.22	700
CIH 10T 8N2 □	0.8±0.15	8.2±10%, 5%	10	26	3500	0.24	700
CIH 10T 10N □	0.8±0.15	10.0±10%, 5%	12	26	3400	0.26	600
CIH 10T 12N □	0.8±0.15	12.0±10%, 5%	12	24	2600	0.28	600
CIH 10T 15N □	0.8±0.15	15.0±10%, 5%	12	24	2300	0.32	500
CIH 10T 18N □	0.8±0.15	18.0±10%, 5%	12	24	2000	0.35	500
CIH 10T 22N □	0.8±0.15	22.0±10%, 5%	12	25	1600	0.40	500
CIH 10T 27N □	0.8±0.15	27.0±10%, 5%	12	25	1400	0.45	500
CIH 10T 33N □	0.8±0.15	33.0±10%, 5%	12	24	1200	0.55	500
CIH 10T 39N □	0.8±0.15	39.0±10%, 5%	12	20	1100	0.60	400
CIH 10T 47N □	0.8±0.15	47.0±10%, 5%	12	20	900	0.77	400
CIH 10T 56N □	0.8±0.15	56.0±10%, 5%	12	20	900	0.75	400
CIH 10T 68N □	0.8±0.15	68.0±10%, 5%	12	(1)20	700	0.85	350
CIH 10T 82N □	0.8±0.15	82.0±10%, 5%	12	(1)20	600	0.95	350
CIH 10T R10 □	0.8±0.15	100.0±10%, 5%	12	(1)20	600	1.00	350
CIH 10T R12 □	0.8±0.15	120.0±10%, 5%	(2)8	-	500	1.20	300
CIH 10T R15 □	0.8±0.15	150.0±10%, 5%	(2)8	-	500	1.20	250
CIH 10T R18 □	0.8±0.15	180.0±10%, 5%	(2)8	-	400	1.30	250
CIH 10T R22 □	0.8±0.15	220.0±10%, 5%	(2)8	-	400	1.50	200
CIH 10T R27 □	0.8±0.15	270.0±10%, 5%	(2)8	-	400	1.50	200

※ □: Tolerance (S: ±0.3nH, J: ±5%, K: ±10%)

※ (1) 500MHz, (2) 50MHz

※ Measurement equipment & Jig : HP4291B +16092A or Equivalent

### Residual inductance

Residual inductance	Series	Test Frequency
0nH	CIH05T, CIH05Q, CIH10T	100MHz
0.02nH	CIH03T	100MHz
0.11nH	CIH02T	100MHz
0.16nH	CIH03S	500MHz (0.6 ~ 27nH)
		300MHz (33 ~ 100nH)
0.30nH	CIH03Q	500MHz (0.6 ~ 27nH)
		300MHz (33 ~ 100nH)
0.43nH	CIH03U	500MHz (0.6 ~ 27nH)
		300MHz (33 ~ 100nH)
0.48nH	CIH03W	500MHz

※ Residual inductance = Short Bar Residual inductance



# Chip Inductor; CIL Series

## General Type

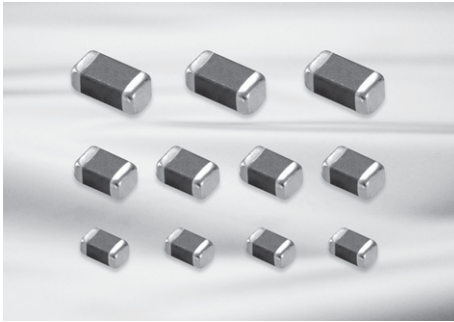

### Feature

- Magnetic shielding eliminates crosstalk, thus permitting higher mounting density.
- Excellent solderability and high thermal resistance for either flow or reflow soldering.
- Monolithic structure for high reliability.

### Application

- Resonance circuits, PLL circuits, Noise suppression, etc.

As it has ferrite body and 100 % Ag internal conductor, the CIL series Inductors have excellent Q characteristics and free of cross talk.

Operating Temp	-40~+85°C
Storage Temp (After mounting)	-40~+85°C

### Dimensions

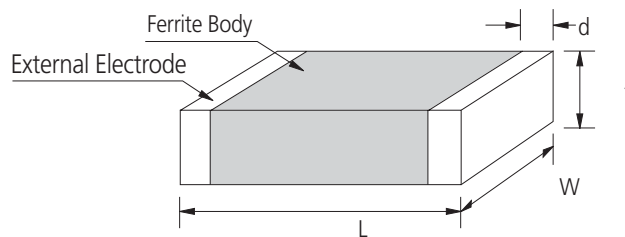

Unit : mm

SIZE CODE	L	W	T	d
05	1.0±0.05	0.5±0.05	0.5±0.05	0.25±0.1
10	1.6±0.15	0.8±0.15	0.8±0.15	0.3±0.2
21	2.0±0.2	1.25±0.2	0.85±0.2 1.25±0.2	0.5+ 0.2,-0.3
31	3.2±0.2	1.6±0.2	0.6±0.2 1.1±0.2	0.5+ 0.2,-0.3

### Part Numbering

**CI**   **L**   **10**   **Y**   **5R6**   **K**   **N**   **C**  
 (1)   (2)   (3)   (4)   (5)   (6)   (7)   (8)

- (1) Chip Inductor
- (2) L:General Type
- (3) Dimension
- (4) Material code(N, J, Y, S)
- (5) Inductance (R10:0.1μH, 5R6:5.6μH, 100:10μH)
- (6) Tolerance(J: ±5%,K: ±10%,M: ±20%)
- (7) Thickness option(N: Standard, A: Thinner than standard, B: Thicker than standard)
- (8) Packaging(C : paper tape, E:embossed tape)



### CIL 1005(0402) Type

Part No.	Thickness (mm)	Inductance ( $\mu$ H)	Q Min.	L, Q test frequency (MHz)	SRF (MHz) Min.	DC resistance ( $\Omega$ ) Max.	Rated current (mA) Max.
CIL 05J 2R2 □	0.5 $\pm$ 0.05	2.2 $\pm$ 20%, 10%	20	10	40	1.70	10

### CIL 1608(0603) Type - Tight Tolerance

Part No.	Thickness (mm)	Inductance ( $\mu$ H)	Q Min.	L, Q test frequency (MHz)	SRF (MHz) Min.	DC resistance ( $\Omega$ ) Max.	Rated current (mA) Max.
CIL10NR10 □	0.80 $\pm$ 0.15	0.10 $\pm$ 5%	15	25	450	0.35	200
CIL10NR12 □	0.80 $\pm$ 0.15	0.12 $\pm$ 5%	15	25	400	0.40	200
CIL10NR15 □	0.80 $\pm$ 0.15	0.15 $\pm$ 5%	15	25	350	0.45	200
CIL10NR18 □	0.80 $\pm$ 0.15	0.18 $\pm$ 5%	15	25	320	0.50	150
CIL10NR22 □	0.80 $\pm$ 0.15	0.22 $\pm$ 5%	15	25	290	0.55	150
CIL10NR27 □	0.80 $\pm$ 0.15	0.27 $\pm$ 5%	15	25	260	0.60	150
CIL10NR33 □	0.80 $\pm$ 0.15	0.33 $\pm$ 5%	15	25	230	0.75	100
CIL10NR39 □	0.80 $\pm$ 0.15	0.39 $\pm$ 5%	15	25	210	0.85	100
CIL10NR47 □	0.80 $\pm$ 0.15	0.47 $\pm$ 5%	15	25	190	0.95	100
CIL10NR56 □	0.80 $\pm$ 0.15	0.56 $\pm$ 5%	15	25	170	1.05	100
CIL10NR68 □	0.80 $\pm$ 0.15	0.68 $\pm$ 5%	15	25	150	1.25	70
CIL10NR82 □	0.80 $\pm$ 0.15	0.82 $\pm$ 5%	15	25	130	1.40	70

\* □: Tolerance (J:  $\pm$ 5%, K:  $\pm$ 10%, M:  $\pm$ 20%)

**CIL 1608(0603) Type - Normal**

Part No.	Thickness (mm)	Inductance (μH)	Q Min.	L, Q test frequency (MHz)	SRF (MHz) Min.	DC resistance (Ω) Max.	Rated current (mA) Max.
CIL 10N 47N □	0.80±0.15	0.047±20%, 10%	10	50	260	0.30	50
CIL 10N 56N □	0.80±0.15	0.056±20%, 10%	10	50	260	0.30	50
CIL 10N 68N □	0.80±0.15	0.068±20%, 10%	10	50	250	0.30	50
CIL 10N 82N □	0.80±0.15	0.082±20%, 10%	10	50	245	0.30	50
CIL 10N R10 □	0.80±0.15	0.10±20%, 10%	15	25	240	0.50	50
CIL 10N R12 □	0.80±0.15	0.12±20%, 10%	15	25	205	0.50	50
CIL 10N R15 □	0.80±0.15	0.15±20%, 10%	15	25	180	0.60	50
CIL 10N R18 □	0.80±0.15	0.18±20%, 10%	15	25	165	0.60	50
CIL 10N R22 □	0.80±0.15	0.22±20%, 10%	15	25	150	0.80	50
CIL 10N R27 □	0.80±0.15	0.27±20%, 10%	15	25	136	0.80	50
CIL 10N R33 □	0.80±0.15	0.33±20%, 10%	15	25	125	0.85	35
CIL 10N R39 □	0.80±0.15	0.39±20%, 10%	15	25	110	1.00	35
CIL 10N R47 □	0.80±0.15	0.47±20%, 10%	15	25	105	1.35	35
CIL 10N R56 □	0.80±0.15	0.56±20%, 10%	15	25	95	1.55	35
CIL 10N R68 □	0.80±0.15	0.68±20%, 10%	15	25	80	1.70	35
CIL 10N R82 □	0.80±0.15	0.82±20%, 10%	15	25	75	2.10	35
CIL 10J 1R0 □	0.80±0.15	1.0±20%, 10%	35	10	70	0.60	25
CIL 10J 1R2 □	0.80±0.15	1.2±20%, 10%	35	10	60	0.80	25
CIL 10J 1R5 □	0.80±0.15	1.5±20%, 10%	35	10	55	0.80	25
CIL 10J 1R8 □	0.80±0.15	1.8±20%, 10%	35	10	50	0.95	25
CIL 10J 2R2 □	0.80±0.15	2.2±20%, 10%	35	10	45	1.15	15
CIL 10J 2R7 □	0.80±0.15	2.7±20%, 10%	35	10	40	1.35	15
CIL 10J 3R3 □	0.80±0.15	3.3±20%, 10%	35	10	38	1.55	15
CIL 10J 3R9 □	0.80±0.15	3.9±20%, 10%	35	10	36	1.70	15
CIL 10J 4R7 □	0.80±0.15	4.7±20%, 10%	35	10	33	2.10	15
CIL 10Y 5R6 □	0.80±0.15	5.6±20%, 10%	35	4	22	1.55	5
CIL 10Y 6R8 □	0.80±0.15	6.8±20%, 10%	35	4	20	1.70	5
CIL 10Y 8R2 □	0.80±0.15	8.2±20%, 10%	35	4	18	2.10	5
CIL 10Y 100 □	0.80±0.15	10.0±20%, 10%	35	2	17	2.55	5
CIL 10Y 120 □	0.80±0.15	12.0±20%, 10%	35	2	15	2.75	5
CIL 10S 150 □	0.80±0.15	15.0±20%, 10%	20	1	14	1.70	1
CIL 10S 180 □	0.80±0.15	18.0±20%, 10%	20	1	13	1.85	1
CIL 10S 220 □	0.80±0.15	22.0±20%, 10%	20	1	11	2.10	1
CIL 10S 270 □	0.80±0.15	27.0±20%, 10%	20	1	10	2.75	1
CIL 10S 330 □	0.80±0.15	33.0±20%, 10%	20	0.4	9	2.95	1

※ □: Tolerance (K: ±10%, M: ±20%)  
 ※ Test equipment: Agilent 4291B+16193A

CIL Series

**CIL 2012(0805) Type**

Part No.	Thickness (mm)	Inductance ( $\mu$ H)	Q Min.	L, Q test frequency (MHz)	SRF (MHz) Min.	DC resistance ( $\Omega$ ) Max.	Rated current (mA) Max.
CIL 21N 47N□	0.85±0.2	0.047±20%, 10%	15	50	320	0.20	300
CIL 21N 68N□	0.85±0.2	0.068±20%, 10%	15	50	280	0.20	300
CIL 21N 82N□	0.85±0.2	0.082±20%, 10%	15	50	255	0.20	300
CIL 21N R10□	0.85±0.2	0.10±20%, 10%	20	25	235	0.20	250
CIL 21N R12□	0.85±0.2	0.12±20%, 10%	20	25	220	0.20	250
CIL 21N R15□	0.85±0.2	0.15±20%, 10%	20	25	200	0.25	250
CIL 21N R18□	0.85±0.2	0.18±20%, 10%	20	25	185	0.25	250
CIL 21N R22□	0.85±0.2	0.22±20%, 10%	20	25	170	0.30	250
CIL 21N R27□	0.85±0.2	0.27±20%, 10%	20	25	150	0.30	250
CIL 21N R33□	0.85±0.2	0.33±20%, 10%	20	25	145	0.30	250
CIL 21N R39□	0.85±0.2	0.39±20%, 10%	25	25	135	0.40	200
CIL 21N R47□	1.25±0.2	0.47±20%, 10%	25	25	125	0.40	200
CIL 21N R56□	1.25±0.2	0.56±20%, 10%	25	25	115	0.50	150
CIL 21N R68□	1.25±0.2	0.68±20%, 10%	25	25	105	0.50	150
CIL 21N R82□	1.25±0.2	0.82±20%, 10%	25	25	100	0.60	150
CIL 21J 1R0□	0.85±0.2	1.0±20%, 10%	45	10	75	0.30	50
CIL 21J 1R2□	0.85±0.2	1.2±20%, 10%	45	10	65	0.40	50
CIL 21J 1R5□	0.85±0.2	1.5±20%, 10%	45	10	60	0.40	50
CIL 21J 1R8□	0.85±0.2	1.8±20%, 10%	45	10	55	0.40	50
CIL 21J 2R2□	0.85±0.2	2.2±20%, 10%	45	10	50	0.50	30
CIL 21J 2R7□	1.25±0.2	2.7±20%, 10%	45	10	45	0.60	30
CIL 21J 3R3□	1.25±0.2	3.3±20%, 10%	45	10	41	0.60	30
CIL 21J 3R9□	1.25±0.2	3.9±20%, 10%	45	10	38	0.80	30
CIL 21J 4R7□	1.25±0.2	4.7±20%, 10%	45	10	35	0.90	30
CIL 21Y 5R6□	1.25±0.2	5.6±20%, 10%	50	4	32	0.50	25
CIL 21Y 6R8□	1.25±0.2	6.8±20%, 10%	50	4	29	0.60	15
CIL 21Y 8R2□	1.25±0.2	8.2±20%, 10%	50	4	26	0.70	15
CIL 21Y 100□	1.25±0.2	10.0±20%, 10%	50	2	24	0.80	15
CIL 21Y 120□	1.25±0.2	12.0±20%, 10%	50	2	22	0.90	15
CIL 21S 150□	1.25±0.2	15.0±20%, 10%	30	1	19	0.80	5
CIL 21S 180□	1.25±0.2	18.0±20%, 10%	30	1	18	0.90	5
CIL 21S 220□	1.25±0.2	22.0±20%, 10%	30	1	16	1.10	5
CIL 21S 270□	1.25±0.2	27.0±20%, 10%	30	1	14	1.15	5
CIL 21S 330□	1.25±0.2	33.0±20%, 10%	30	0.4	13	1.25	5

\* □: Tolerance (K: ±10%, M: ±20%)

\* Test equipment: Agilent 4291B+16193A

CIL 3216(1206) Type

Part No.	Thickness (mm)	Inductance (μH)	Q Min.	L, Q test frequency (MHz)	SRF (MHz) Min.	DC resistance (Ω) Max.	Rated current (mA) Max.
CIL 31N 47N□	0.6±0.2	0.047±20%, 10%	20	50	320	0.15	300
CIL 31N 68N□	0.6±0.2	0.068±20%, 10%	20	50	280	0.25	300
CIL 31N R10□	0.6±0.2	0.10±20%, 10%	20	25	235	0.25	250
CIL 31N R12□	0.6±0.2	0.12±20%, 10%	20	25	220	0.30	250
CIL 31N R15□	0.6±0.2	0.15±20%, 10%	20	25	200	0.30	250
CIL 31N R18□	0.6±0.2	0.18±20%, 10%	20	25	185	0.40	250
CIL 31N R22□	0.6±0.2	0.22±20%, 10%	20	25	170	0.40	250
CIL 31N R27□	0.6±0.2	0.27±20%, 10%	20	25	150	0.50	250
CIL 31N R33□	0.6±0.2	0.33±20%, 10%	20	25	145	0.60	250
CIL 31N R39□	1.1±0.2	0.39±20%, 10%	25	25	135	0.50	200
CIL 31N R47□	1.1±0.2	0.47±20%, 10%	25	25	125	0.60	200
CIL 31N R56□	1.1±0.2	0.56±20%, 10%	25	25	115	0.70	150
CIL 31N R68□	1.1±0.2	0.68±20%, 10%	25	25	105	0.80	150
CIL 31N R82□	1.1±0.2	0.82±20%, 10%	25	25	100	0.90	150
CIL 31J 1R0□	0.6±0.2	1.0±20%, 10%	45	10	75	0.40	100
CIL 31J 1R2□	0.6±0.2	1.2±20%, 10%	45	10	65	0.50	100
CIL 31J 1R5□	1.1±0.2	1.5±20%, 10%	45	10	60	0.50	50
CIL 31J 1R8□	1.1±0.2	1.8±20%, 10%	45	10	55	0.50	50
CIL 31J 2R2□	1.1±0.2	2.2±20%, 10%	45	10	50	0.60	50
CIL 31J 2R7□	1.1±0.2	2.7±20%, 10%	45	10	45	0.60	50
CIL 31J 3R3□	1.1±0.2	3.3±20%, 10%	45	10	41	0.70	50
CIL 31J 3R9□	1.1±0.2	3.9±20%, 10%	45	10	38	0.80	50
CIL 31J 4R7□	1.1±0.2	4.7±20%, 10%	45	10	35	0.90	50
CIL 31Y 5R6□	1.1±0.2	5.6±20%, 10%	50	4	32	0.70	25
CIL 31Y 6R8□	1.1±0.2	6.8±20%, 10%	50	4	29	0.80	25
CIL 31Y 8R2□	1.1±0.2	8.2±20%, 10%	50	4	26	0.90	25
CIL 31Y 100□	1.1±0.2	10.0±20%, 10%	50	2	24	1.00	25
CIL 31Y 120□	1.1±0.2	12.0±20%, 10%	50	2	22	1.05	15
CIL 31S 150□	1.1±0.2	15.0±20%, 10%	35	1	19	0.70	5
CIL 31S 180□	1.1±0.2	18.0±20%, 10%	35	1	18	0.70	5
CIL 31S 220□	1.1±0.2	22.0±20%, 10%	35	1	16	0.90	5
CIL 31S 270□	1.1±0.2	27.0±20%, 10%	35	1	14	0.90	5
CIL 31S 330□	1.1±0.2	33.0±20%, 10%	35	0.4	13	1.05	5

\* □: Tolerance (K:±10%,M:±20%)  
\* Test equipment: Agilent 4291B+16193A



## CIL 1005(0402) Type

### ■ IMPEDANCE CHARACTERISTICS

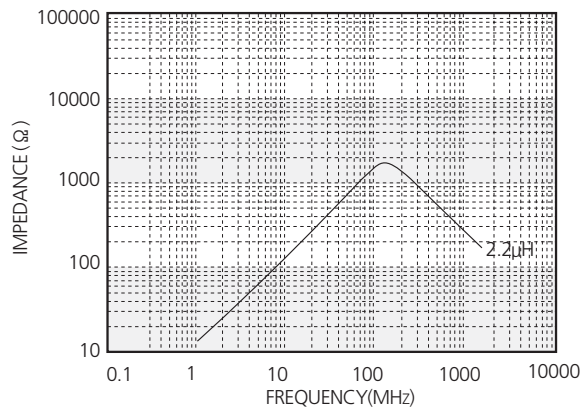

### ■ Q CHARACTERISTICS

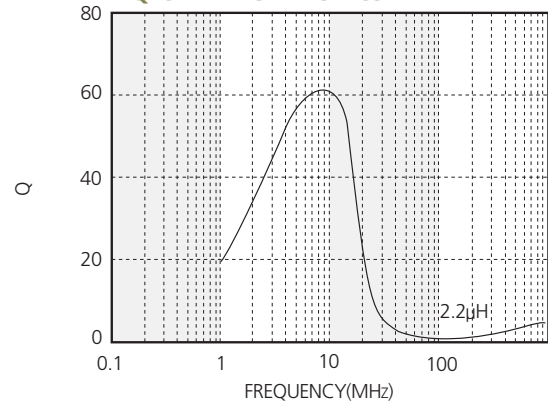

### ■ DC BIAS CHARACTERISTICS

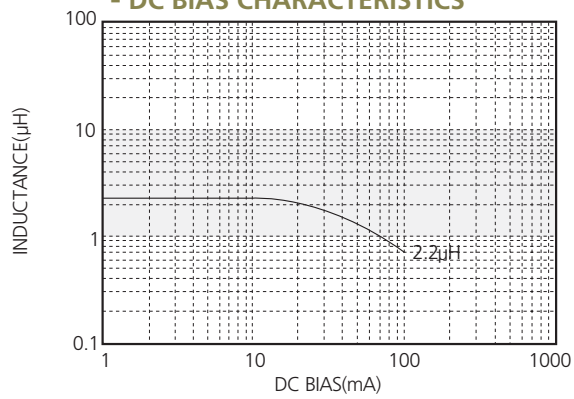

**CIL 1608(0603) Type - Tight Tolerance**

■ IMPEDANCE CHARACTERISTICS

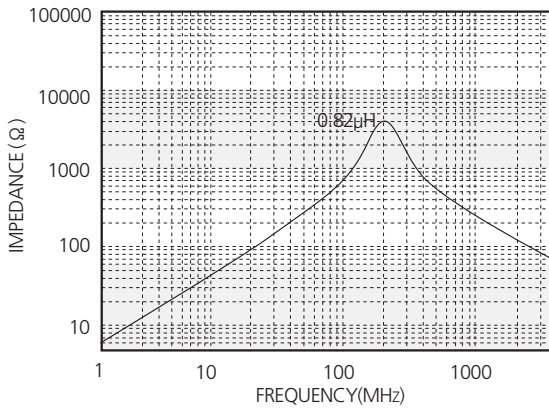

■ Q CHARACTERISTICS

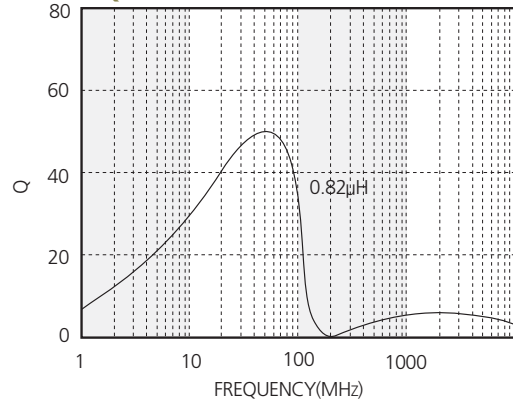

■ DC BIAS CHARACTERISTICS

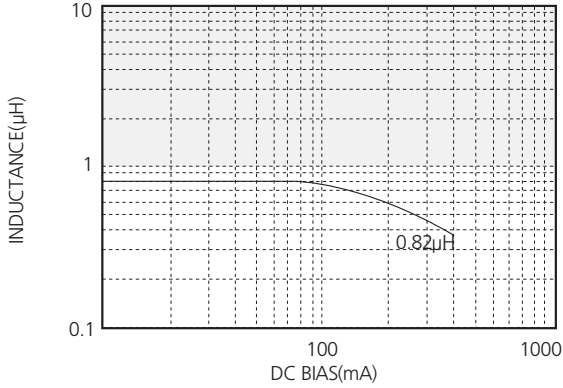

**CIL 1608(0603) Type - Normal**

■ IMPEDANCE CHARACTERISTICS

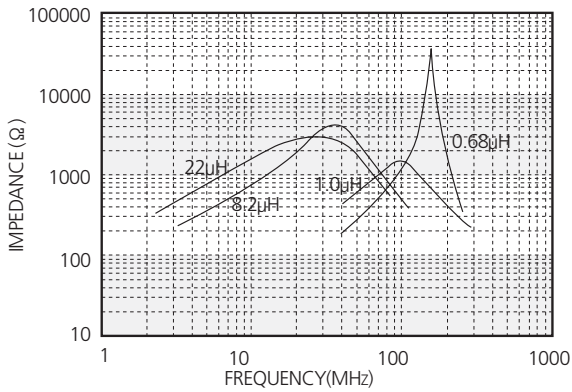

■ Q CHARACTERISTICS

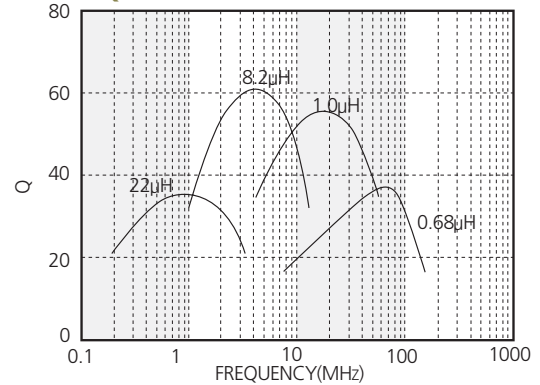

■ DC BIAS CHARACTERISTICS

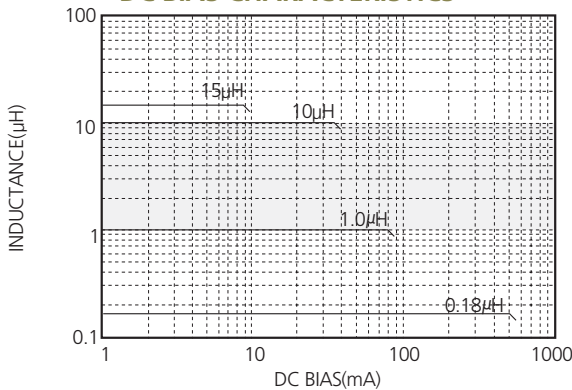

CIL  
Series



### CIL 2012(0805) Type

#### ■ IMPEDANCE CHARACTERISTICS

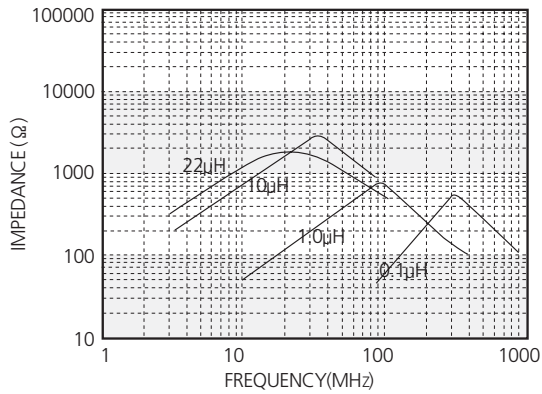

#### ■ Q CHARACTERISTICS

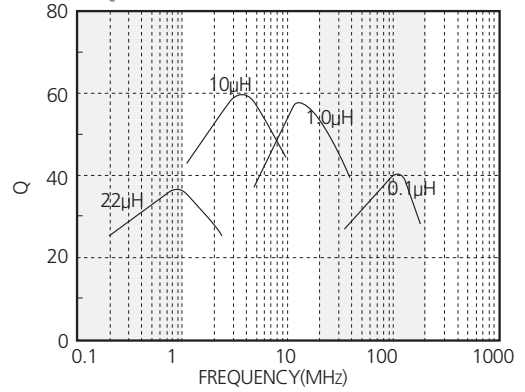

#### ■ DC BIAS CHARACTERISTICS

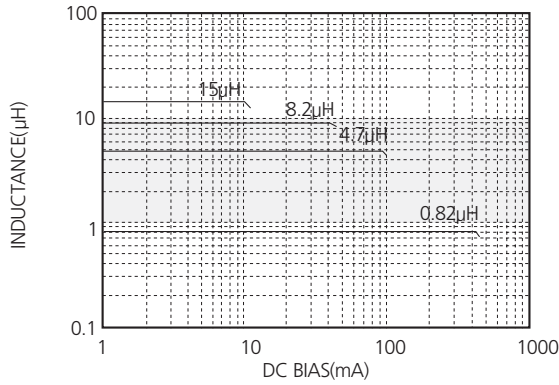

### CIL 3216(1206) Type

#### ■ IMPEDANCE CHARACTERISTICS

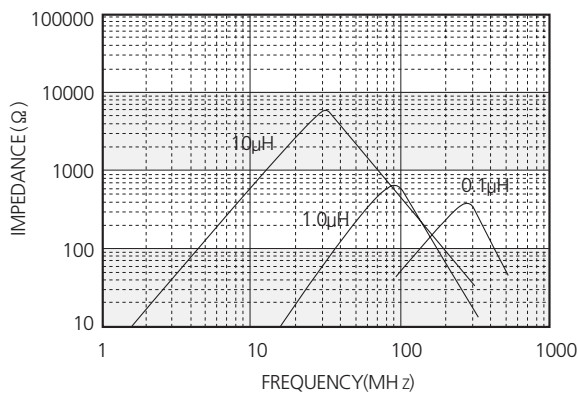

#### ■ Q CHARACTERISTICS

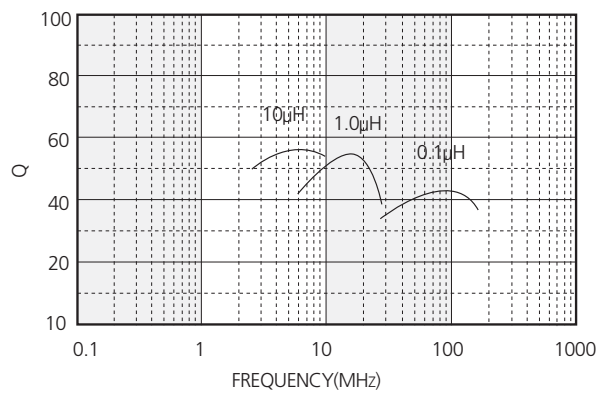

#### ■ DC BIAS CHARACTERISTICS

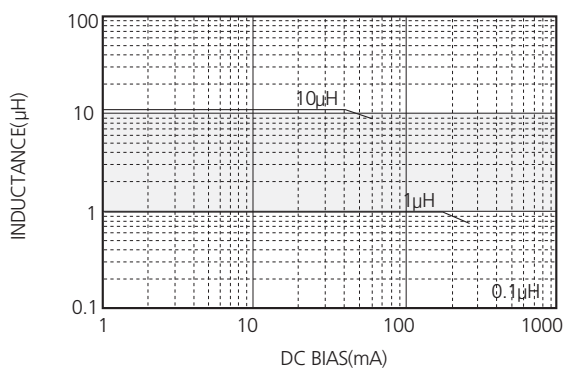



# Chip Bead ; CIB/CIM Series

## For EMI Suppression



### Feature

- Smallest beads suitable for surface mounting
- Perfect shape for automatic mounting, with no directionality.
- Excellent solderability and high heat resistance for either flow or reflow soldering.
- Monolithic inorganic material construction for high reliability.
- Closed magnetic circuit configuration avoids crosstalk and is suitable for high density PCBs.

### Application

- High frequency EMI prevention application to computers, printers, VCRs, TVs and mobile phones.

The CIB/CIM Series are used for EMI suppression filter. These beads suppress electro-magnetic wave noise by increased impedance, especially by increased resistance at noise frequency.

#### CIB Series

The CIB Series is composed of mono-layer internal conductor that allows low impedance and low DC resistance.

#### CIM Series

The CIM Series display high impedance because it is composed of a multilayered internal conductor and has excellent attenuation characteristics for wide band frequencies.

Operating Temp	-55~+125℃
Storage Temp (After mounting)	-55~+125℃

### Dimensions

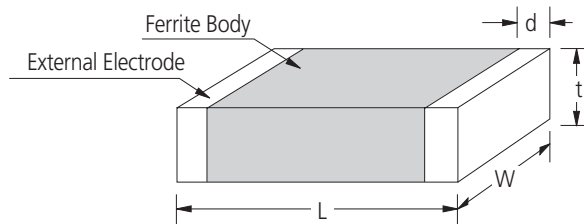

Unit: mm

SIZE CODE	L	W	t	d
03	0.6±0.03	0.3±0.03	0.3±0.03	0.15±0.05
05	1.0±0.05	0.5±0.05	0.5±0.05	0.25±0.1
10	1.6±0.15	0.8±0.15	0.8±0.15	0.3±0.2
21	2.0±0.2	1.25±0.2	0.9±0.2	0.5+ 0.2,-0.3
31	3.2±0.2	1.6±0.2	1.1±0.2	0.5+ 0.2,-0.3
32	3.2±0.2	2.5±0.2	1.3±0.2	0.5±0.3
41	4.5±0.2	1.6±0.2	1.6±0.2/1.2±0.2	0.5±0.3

### Part Numbering

**C** (1)   **M** (2)   **03** (3)   **J** (4)   **121** (5)   **N** (6)   **C** (7)

- (1) Chip Beads
- (2) B: Mono-layer type, M: Multi-layer type
- (3) Dimension
- (4) Material Code
- (5) Nominal impedance (110: 11Ω ; 121: 120Ω)
- (6) Thickness option (N: Standard, A: Thinner than standard, B: Thicker than standard)
- (7) Packaging (C: paper tape, E: embossed tape)

### CIM 0603(0201) Type

Part No.	Thickness (mm)	Impedance ( $\Omega$ ) $\pm 25\%$ @100 MHz	DC Resistance ( $\Omega$ ) Max.	Rated Current (mA) Max.
CIM 03U 800N □	0.3 $\pm$ 0.03	80	0.40	200
CIM 03U 121N □	0.3 $\pm$ 0.03	120	0.50	200
CIM 03U 241N □	0.3 $\pm$ 0.03	240	0.75	200
CIM 03U 471N □	0.3 $\pm$ 0.03	470	1.30	100
CIM 03U 601N □	0.3 $\pm$ 0.03	600	1.50	100
CIM 03J 750N □	0.3 $\pm$ 0.03	75	0.50	300
CIM 03J 121N □	0.3 $\pm$ 0.03	120	0.50	200
CIM 03J 241N □	0.3 $\pm$ 0.03	240	1.00	100

\* Test equipment : Agilent E4991A +16197A or Equivalent

### Electrical Characteristics

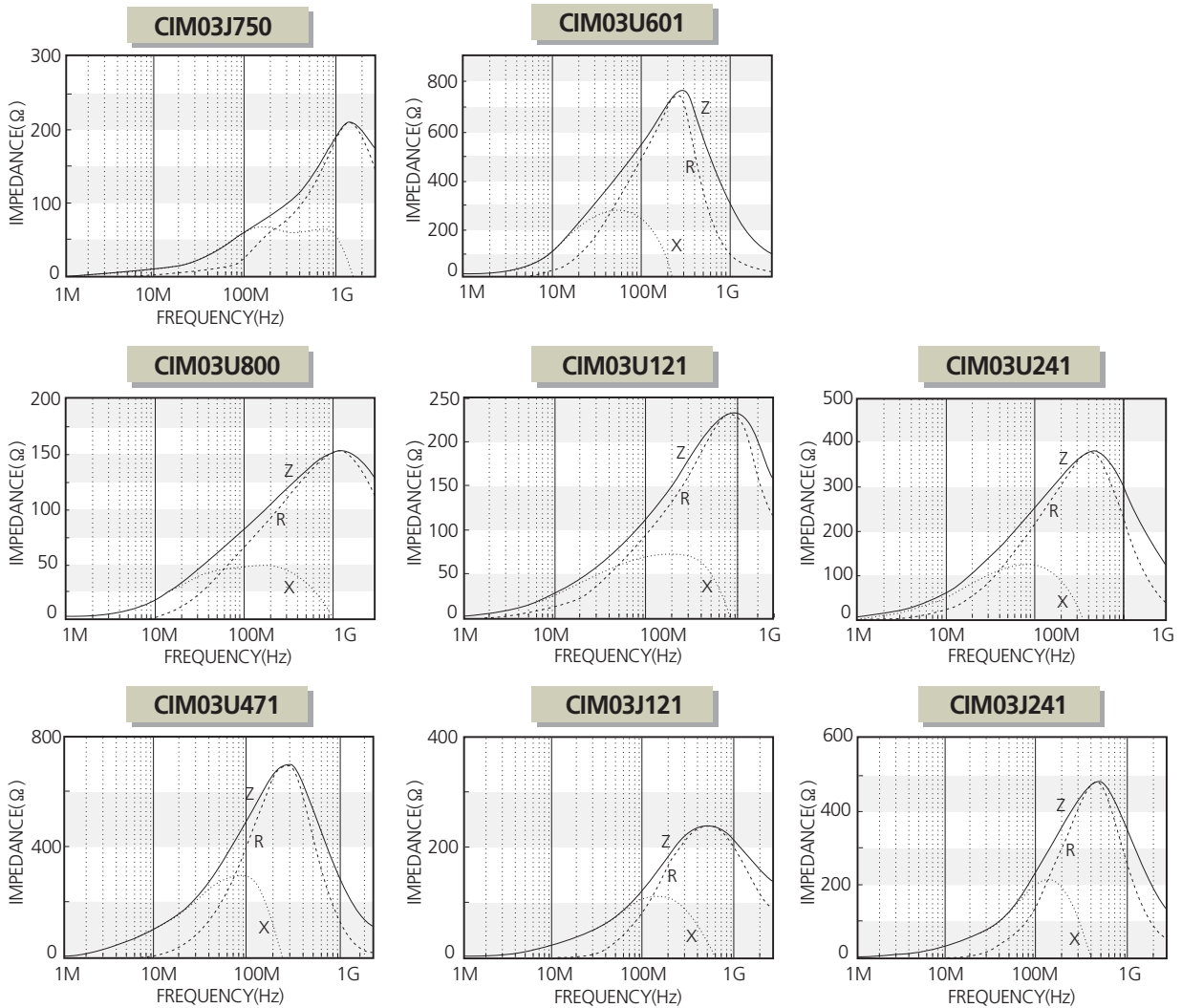

**CIB/CIM1005(0402) Type**

Part No.	Thickness (mm)	Impedance ( $\Omega$ ) $\pm 25\%$ @100 MHz	DC Resistance ( $\Omega$ ) Max.	Rated Current (mA) Max.
CIB 05J 100 N□	0.5±0.05	10(typ.)	0.05	1200
CIM 05U 100 N□	0.5±0.05	10	0.05	1200
CIM 05U 300 N□	0.5±0.05	30	0.10	700
CIM 05U 600 N□	0.5±0.05	60	0.15	600
CIM 05U 800 N□	0.5±0.05	80	0.20	600
CIM 05U 121 N□	0.5±0.05	120	0.25	600
CIM 05U 221 N□	0.5±0.05	220	0.35	500
CIM 05U 241 N□	0.5±0.05	240	0.35	400
CIM 05U 301 N□	0.5±0.05	300	0.45	400
CIM 05U 471 N□	0.5±0.05	470	0.55	300
CIM 05U 601 N□	0.5±0.05	600	0.60	300
CIM 05U 102 N□	0.5±0.05	1000	0.80	300
CIM 05J 300 N□	0.5±0.05	30	0.20	700
CIM 05J 600 N□	0.5±0.05	60	0.20	650
CIM 05J 800 N□	0.5±0.05	80	0.25	600
CIM 05J 121 N□	0.5±0.05	120	0.25	500
CIM 05J 221 N□	0.5±0.05	220	0.35	400
CIM 05J 241 N□	0.5±0.05	240	0.35	400
CIM 05J 301 N□	0.5±0.05	300	0.45	400
CIM 05J 471 N□	0.5±0.05	470	0.55	300
CIM 05J 601 N□	0.5±0.05	600	0.60	300
CIM 05J 102 N□	0.5±0.05	1000	0.80	250
CIM 05J 152 N□	0.5±0.05	1500	1.00	250
CIM 05J 182 N□	0.5±0.05	1800	1.40	200
CIM 05N 750 N□	0.5±0.05	75	0.35	300
CIM 05N 121 N□	0.5±0.05	120	0.55	300
CIM 05N 221 N□	0.5±0.05	220	0.80	200
CIM 05F 050 N□	0.5±0.05	5	0.08	500
CIM 05F 100 N□	0.5±0.05	10	0.10	300
CIM 05F 220 N□	0.5±0.05	22	0.20	300
CIM 05F 470 N□	0.5±0.05	47	0.35	300
CIM 05F 750 N□	0.5±0.05	75	0.40	300
CIM 05F 121 N□	0.5±0.05	120	0.55	300
CIM 05F 221 N□	0.5±0.05	220	0.80	200
CIM 05H 800 N□	0.5±0.05	80	0.20	450
CIM 05H 121 N□	0.5±0.05	120	0.25	400
CIM 05H 241 N□	0.5±0.05	240	0.31	400
CIM 05H 431 N□	0.5±0.05	430	0.50	350
CIM 05H 601 N□	0.5±0.05	600	0.80	200

※ Test equipment: Agilent E4991A + 16192A or Equivalent

CIB/CIM Series

**Electrical Characteristics**

**CIB05J100**

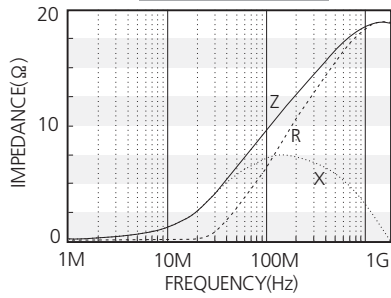

**CIM05U100**

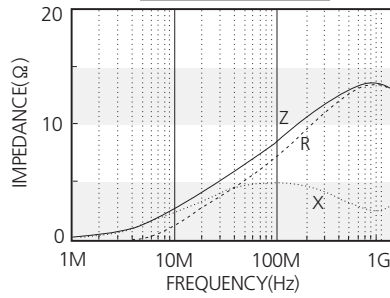

**CIM05U300**

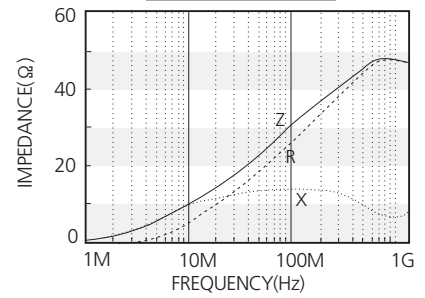

**CIM05U600**

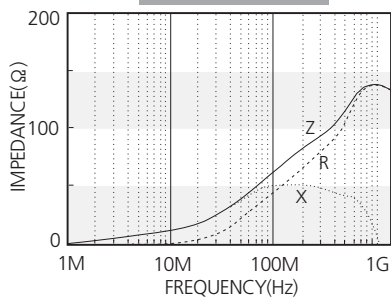

**CIM05U800**

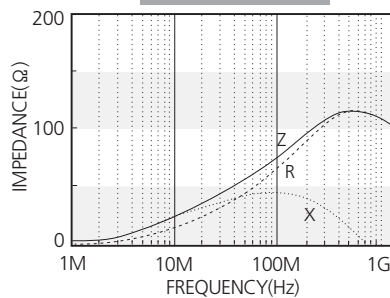

**CIM05U121**

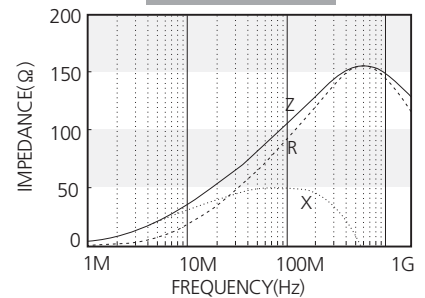

**CIM05U221**

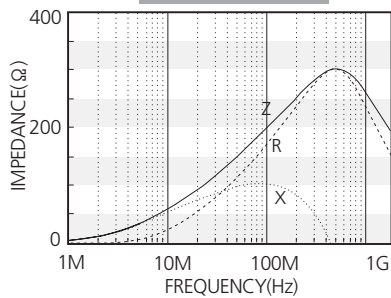

**CIM05U241**

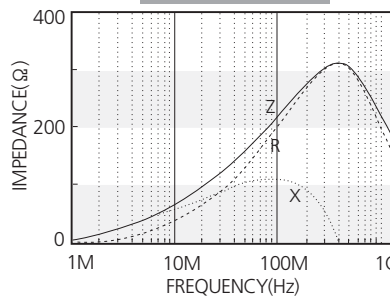

**CIM05U301**

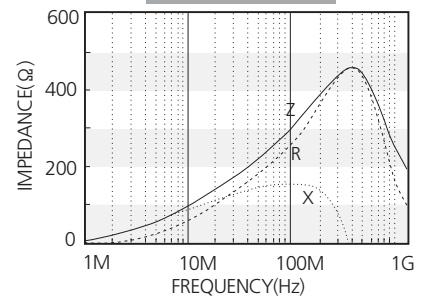

**CIM05U471**

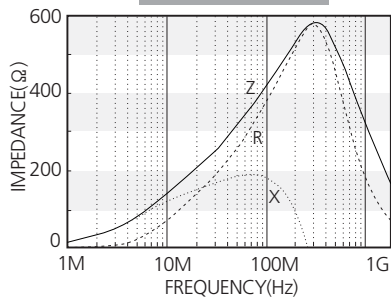

**CIM05U601**

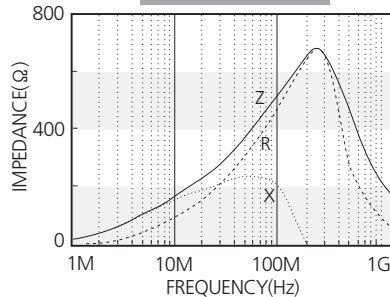

**CIM05U102**

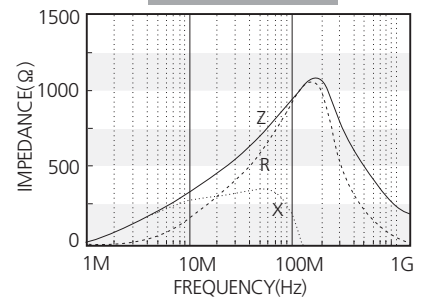

**CIM05N750**

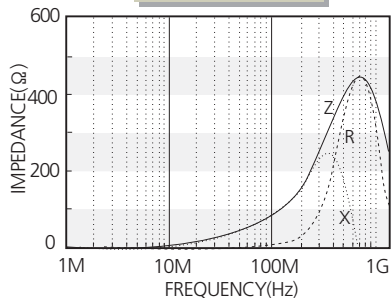

**CIM05N121**

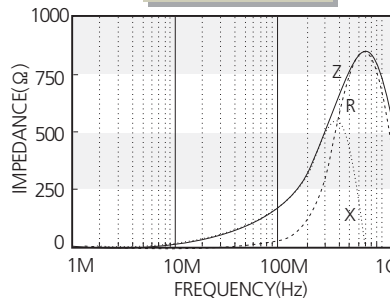

**CIM05N221**

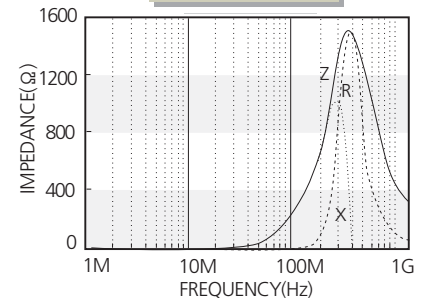

Electrical Characteristics

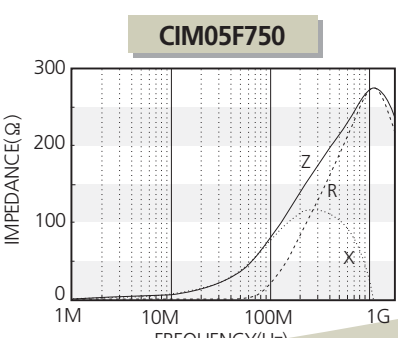
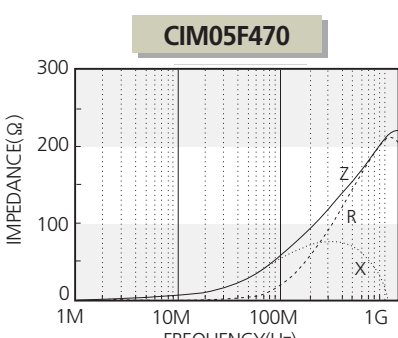
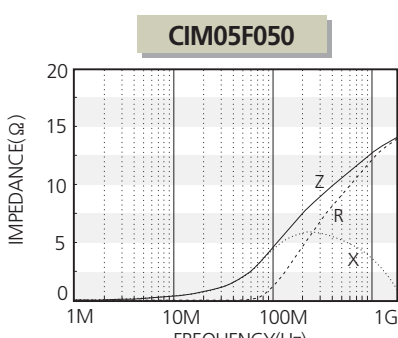
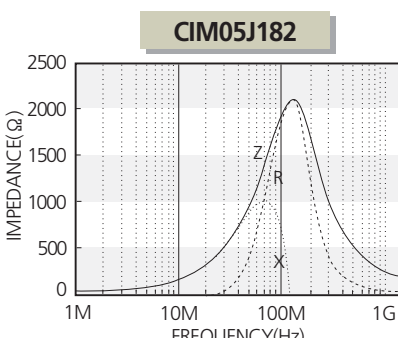
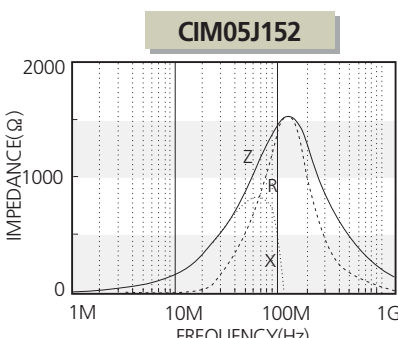
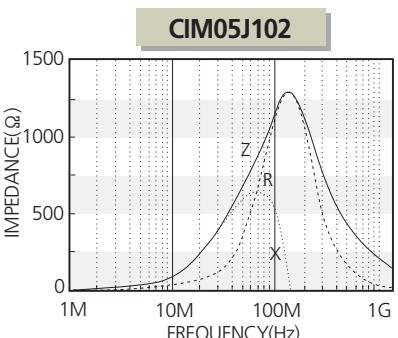
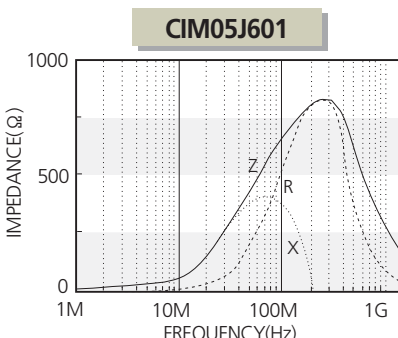
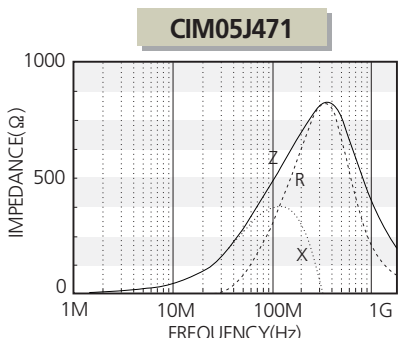
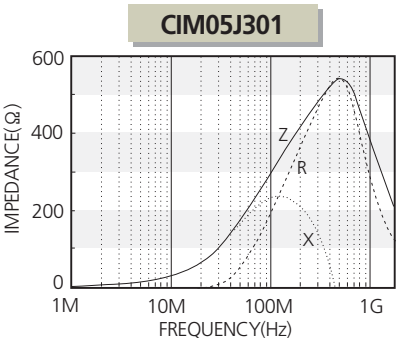
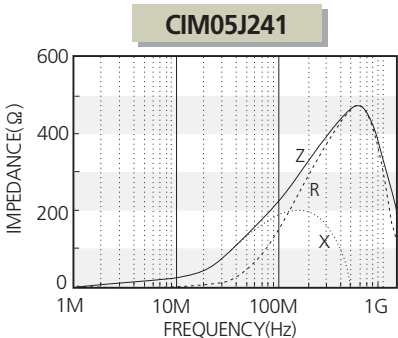
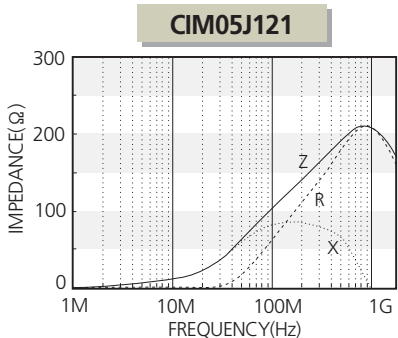
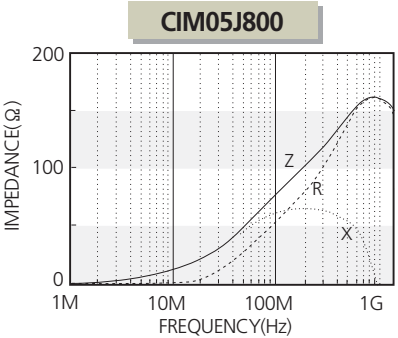
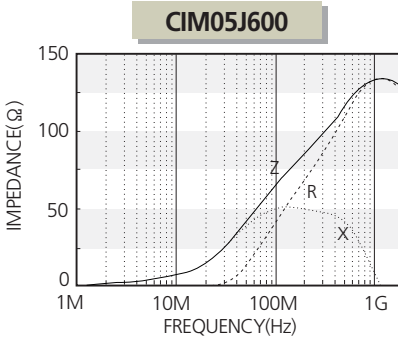
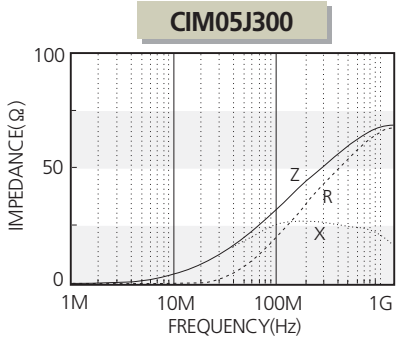

CIB/CIM  
Series

Electrical Characteristics

**CIM05F121**

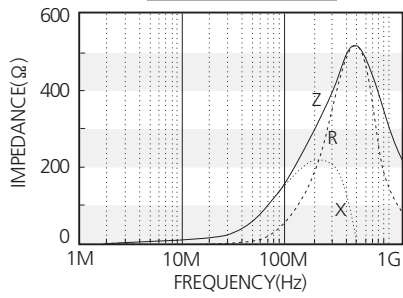

**CIM05F221**

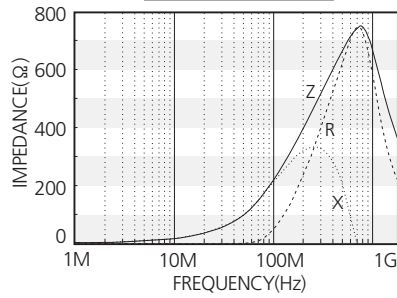

**CIM05H800**

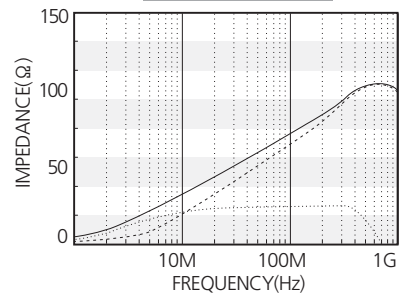

**CIM05H121**

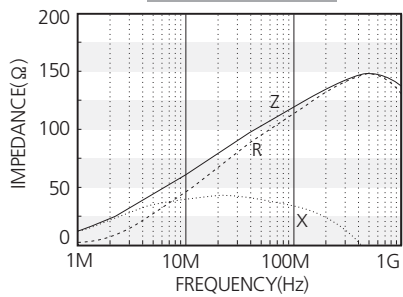

**CIM05H241**

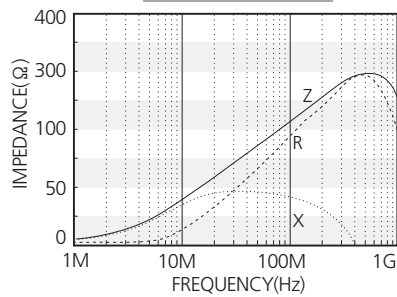

**CIM05H431**

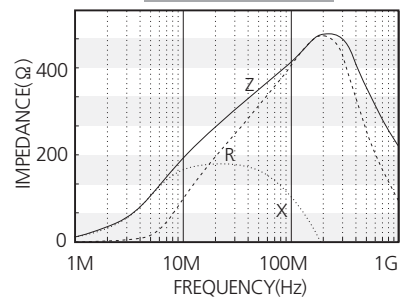

**CIM05H601**

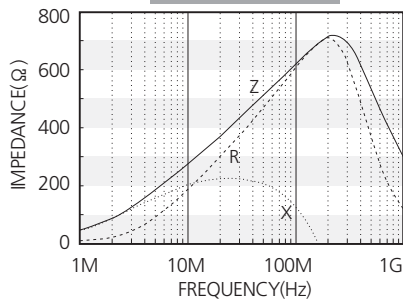

**CIM05H800**

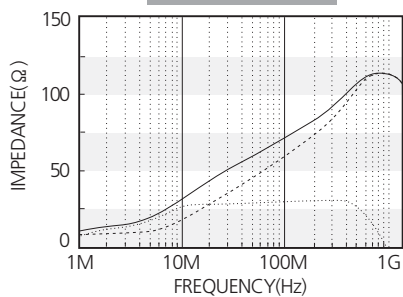

**CIM05H241**

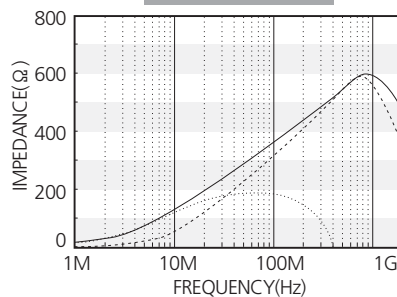

**CIM05H121**

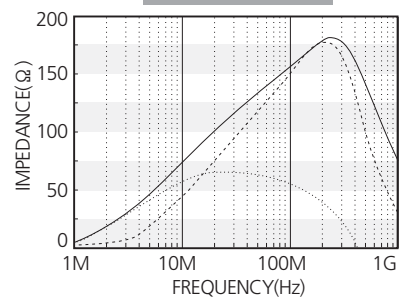

**CIB/CIM 1608(0603) Type**

Part No.	Thickness (mm)	Impedance ( $\Omega$ ) $\pm 25\%$ @100 MHz	DC Resistance ( $\Omega$ ) Max.	Rated Current (mA) Max.
CIB 10P 100 N □	0.8 $\pm$ 0.15	10(typ.)	0.05	1000
CIB 10P 220 N □	0.8 $\pm$ 0.15	22	0.05	1500
CIB 10P 260 N □	0.8 $\pm$ 0.15	26	0.08	1000
CIB 10P 300 N □	0.8 $\pm$ 0.15	30	0.08	1000
CIB 10P 330 N □	0.8 $\pm$ 0.15	33	0.08	1000
CIM 10U 800 N □	0.8 $\pm$ 0.15	80	0.10	600
CIM 10U 121 N □	0.8 $\pm$ 0.15	120	0.15	500
CIM 10U 221 N □	0.8 $\pm$ 0.15	220	0.25	400
CIM 10U 241 N □	0.8 $\pm$ 0.15	240	0.25	400
CIM 10U 301 N □	0.8 $\pm$ 0.15	300	0.30	500
CIM 10U 471 N □	0.8 $\pm$ 0.15	470	0.35	300
CIM 10U 601 N □	0.8 $\pm$ 0.15	600	0.38	500
CIM 10U 102 N □	0.8 $\pm$ 0.15	1000	0.50	400
CIM 10U 202 N □	0.8 $\pm$ 0.15	2000(at 70MHz)	1.20	200
CIB 10J 300 N □	0.8 $\pm$ 0.15	30	0.10	1000
CIM 10J 400 N □	0.8 $\pm$ 0.15	40	0.12	600
CIM 10J 470 N □	0.8 $\pm$ 0.15	47	0.12	600
CIM 10J 600 N □	0.8 $\pm$ 0.15	60	0.12	600
CIM 10J 750 N □	0.8 $\pm$ 0.15	75	0.15	550
CIM 10J 800 N □	0.8 $\pm$ 0.15	80	0.15	550
CIM 10J 121 N □	0.8 $\pm$ 0.15	120	0.20	500
CIM 10J 151 N □	0.8 $\pm$ 0.15	150	0.20	400
CIM 10J 221 N □	0.8 $\pm$ 0.15	220	0.30	400
CIM 10J 241 N □	0.8 $\pm$ 0.15	240	0.30	400
CIM 10J 301 N □	0.8 $\pm$ 0.15	300	0.35	400
CIM 10J 331 N □	0.8 $\pm$ 0.15	330	0.35	400
CIM 10J 471 N □	0.8 $\pm$ 0.15	470	0.35	300
CIM 10J 601 N □	0.8 $\pm$ 0.15	600	0.45	300
CIM 10J 751 N □	0.8 $\pm$ 0.15	750	0.50	300
CIM 10J 102 N □	0.8 $\pm$ 0.15	1000	0.60	250
CIM 10J 152 N □	0.8 $\pm$ 0.15	1500	0.70	250
CIM 10J 252 N □	0.8 $\pm$ 0.15	2500	1.50	200
CIM 10K 152 N □	0.8 $\pm$ 0.15	1500	0.80	250
CIM 10K 202 N □	0.8 $\pm$ 0.15	2000	1.00	200
CIM 10K 252 N □	0.8 $\pm$ 0.15	2500	1.20	200
CIM 10N 700 N □	0.8 $\pm$ 0.15	70	0.30	500
CIM 10N 121 N □	0.8 $\pm$ 0.15	120	0.45	400
CIM 10N 241 N □	0.8 $\pm$ 0.15	240	0.60	300
CIM 10F 470 N □	0.8 $\pm$ 0.15	47	0.25	550
CIM 10F 600 N □	0.8 $\pm$ 0.15	60	0.25	550
CIM 10F 121 N □	0.8 $\pm$ 0.15	120	0.30	500
CIM 10F 331 N □	0.8 $\pm$ 0.15	330	0.58	400
CIM 10F 471 N □	0.8 $\pm$ 0.15	470	0.85	300

\* Test equipment: Agilent E4991A + 16193A or Equivalent





Electrical Characteristics

**CIB10J300**

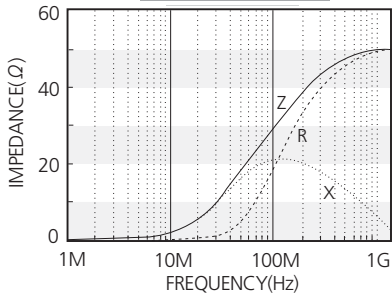

**CIM10J400**

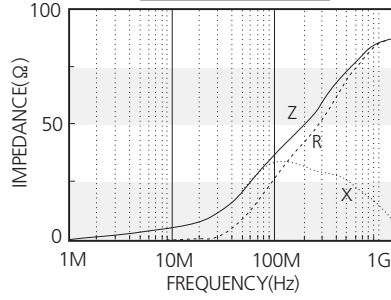

**CIM10J470**

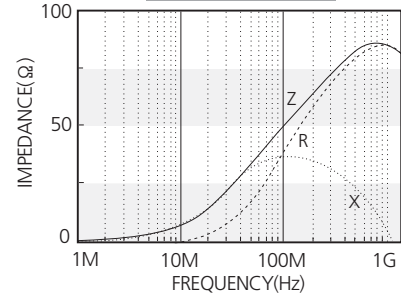

**CIM10J600**

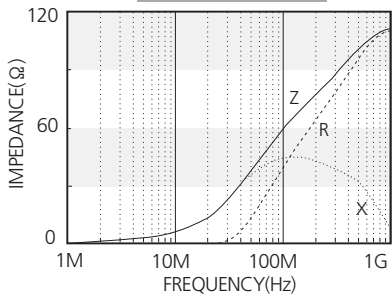

**CIM10J750**

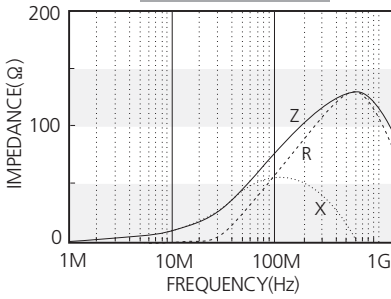

**CIM10J800**

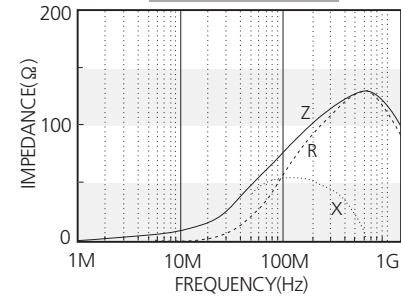

**CIM10J121**

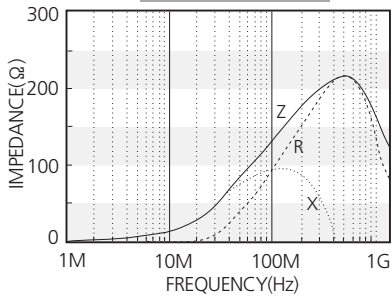

**CIM10J151**

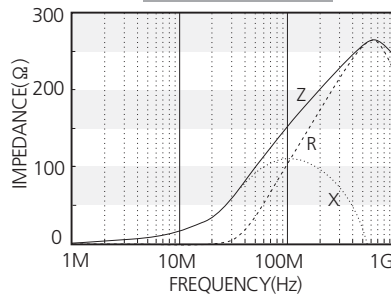

**CIM10J221**

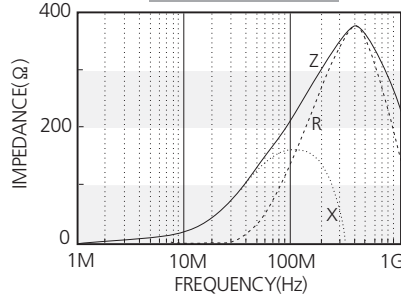

**CIM10J241**

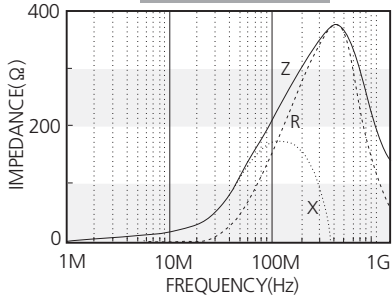

**CIM10J301**

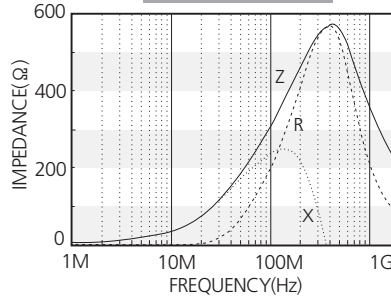

**CIM10J331**

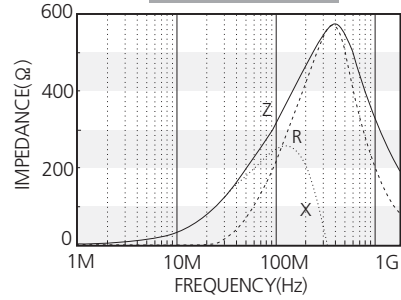

**CIM10J471**

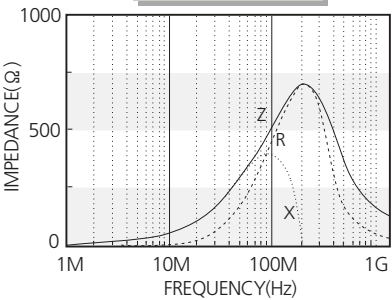

**CIM10J601**

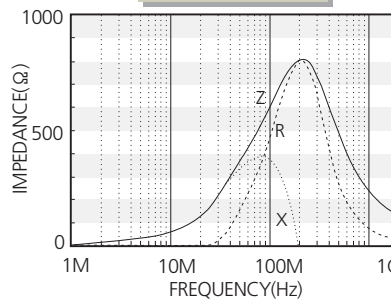

**CIM10J751**

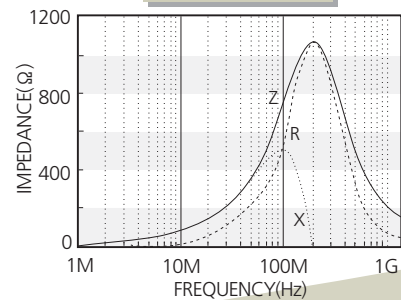

CIB/CIM  
Series

## Electrical Characteristics

**CIM10J102**

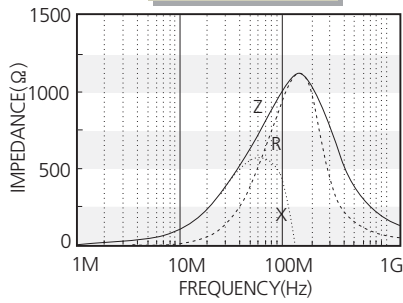

**CIM10J152**

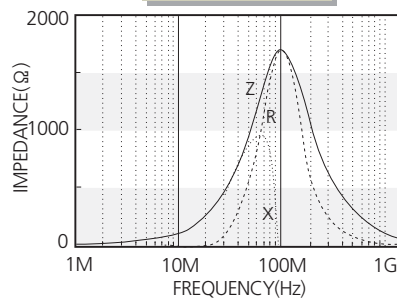

**CIM10J252**

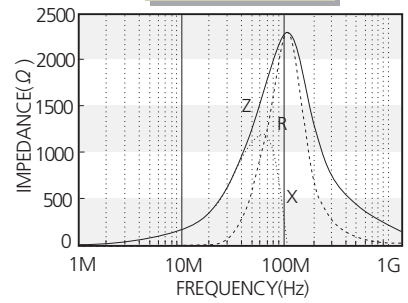

**CIM10K152**

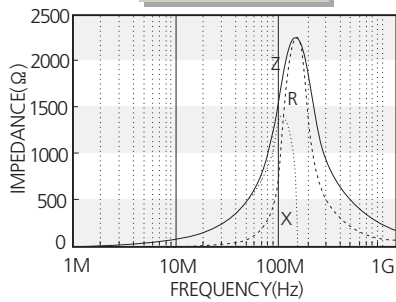

**CIM10K202**

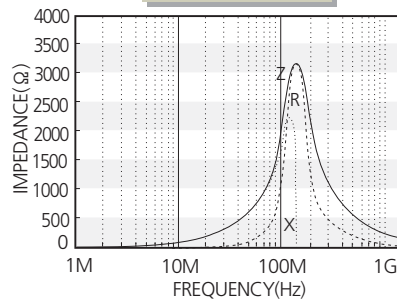

**CIM10K252**

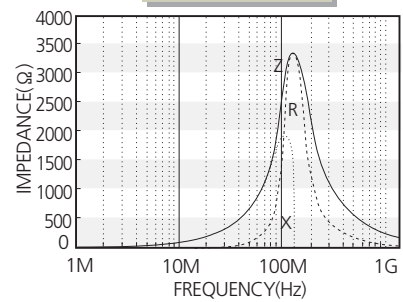

**CIM10N700**

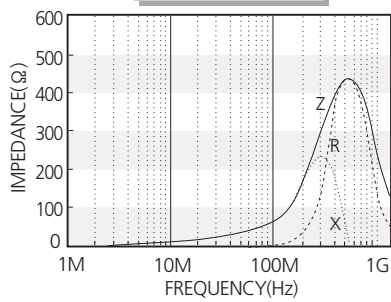

**CIM10N121**

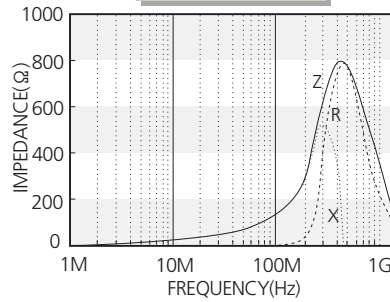

**CIM10N241**

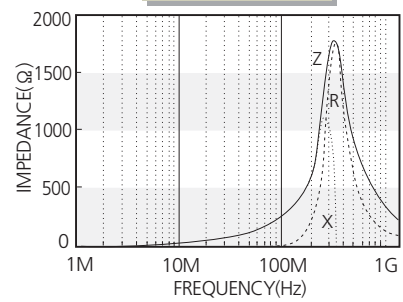

**CIM10F600**

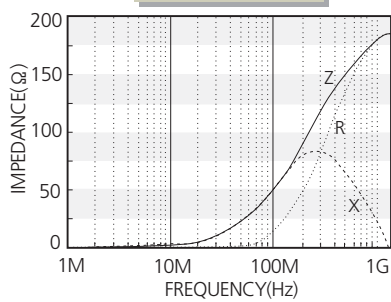

**CIM10F121**

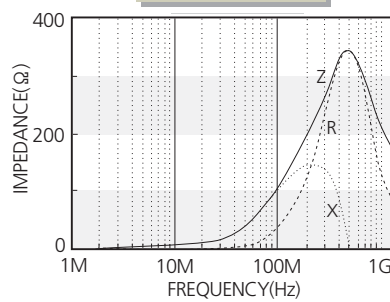

**CIB/CIM 2012(0805) Type**

Part No.	Thickness (mm)	Impedance ( $\Omega$ ) $\pm 25\%$ @100 MHz	DC Resistance ( $\Omega$ ) Max.	Rated Current (mA) Max.
CIB 21P 110 N □	0.9 $\pm$ 0.2	11(typ.)	0.01	2000
CIB 21P 150 N □	0.9 $\pm$ 0.2	15	0.01	2000
CIB 21P 260 N □	0.9 $\pm$ 0.2	26	0.01	2000
CIB 21P 300 N □	0.9 $\pm$ 0.2	30	0.05	2000
CIB 21P 330 N □	0.9 $\pm$ 0.2	33	0.05	1500
CIB 21P 470 N □	0.9 $\pm$ 0.2	47	0.05	1500
CIB 21U 600 N □	0.9 $\pm$ 0.2	60	0.08	900
CIM 21U 800 N □	0.9 $\pm$ 0.2	80	0.10	900
CIM 21U 101 N □	0.9 $\pm$ 0.2	100	0.10	800
CIM 21U 121 N □	0.9 $\pm$ 0.2	120	0.10	800
CIM 21U 151 N □	0.9 $\pm$ 0.2	150	0.15	600
CIM 21U 241 N □	0.9 $\pm$ 0.2	240	0.15	600
CIM 21U 301 N □	0.9 $\pm$ 0.2	300	0.15	500
CIM 21U 471 N □	0.9 $\pm$ 0.2	470	0.30	500
CIM 21U 601 N □	0.9 $\pm$ 0.2	600	0.30	500
CIM 21U 102 N □	0.9 $\pm$ 0.2	1000(at 70MHz)	0.40	500
CIM 21U 202 N □	0.9 $\pm$ 0.2	2000(at 70MHz)	0.70	300
CIB 21J 260 N □	0.9 $\pm$ 0.2	26	0.05	2000
CIB 21J 300 N □	0.9 $\pm$ 0.2	30	0.05	2000
CIB 21J 400 N □	0.9 $\pm$ 0.2	40	0.05	2000
CIM 21J 600 N □	0.9 $\pm$ 0.2	60	0.08	900
CIM 21J 800 N □	0.9 $\pm$ 0.2	80	0.08	1000
CIM 21J 121 N □	0.9 $\pm$ 0.2	120	0.15	800
CIM 21J 151 N □	0.9 $\pm$ 0.2	150	0.15	500
CIM 21J 221 N □	0.9 $\pm$ 0.2	220	0.20	500
CIM 21J 241 N □	0.9 $\pm$ 0.2	240	0.20	500
CIM 21J 301 N □	0.9 $\pm$ 0.2	300	0.20	500
CIM 21J 471 N □	0.9 $\pm$ 0.2	470	0.25	500
CIM 21J 601 N □	0.9 $\pm$ 0.2	600	0.25	500
CIM 21J 751 N □	0.9 $\pm$ 0.2	750	0.35	400
CIM 21J 102 N □	0.9 $\pm$ 0.2	1000	0.35	500
CIM 21J 152 N □	0.9 $\pm$ 0.2	1500(at 70MHz)	0.45	500
CIM 21J 182 N □	0.9 $\pm$ 0.2	1800(at 70MHz)	0.45	500
CIM 21J 202 N □	0.9 $\pm$ 0.2	2000(at 70MHz)	0.50	500
CIM 21J 222 N □	0.9 $\pm$ 0.2	2200(at 70MHz)	0.70	300
CIM 21J 252 N □	0.9 $\pm$ 0.2	2500(at 50MHz)	0.70	300
CIM 21J 302 N □	0.9 $\pm$ 0.2	3000(at 50MHz)	0.60	300
CIM 21K 152 N □	0.9 $\pm$ 0.2	1500	0.45	300
CIM 21K 252 N □	0.9 $\pm$ 0.2	2500	0.80	250
CIM 21N 560 N □	0.9 $\pm$ 0.2	56	0.20	600
CIM 21N 700 N □	0.9 $\pm$ 0.2	70	0.20	600
CIM 21N 121 N □	0.9 $\pm$ 0.2	120	0.25	500
CIM 21N 241 N □	0.9 $\pm$ 0.2	240	0.30	400

※ Test equipment: Agilent E4991A + 16193A or Equivalent

CIB/CIM Series

**Electrical Characteristics**

**CIB21P110**

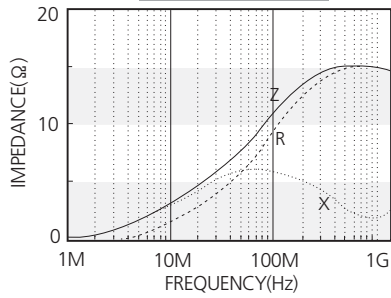

**CIB21P150**

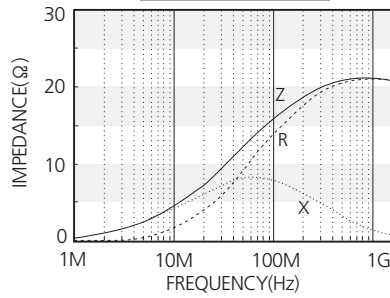

**CIB21P260**

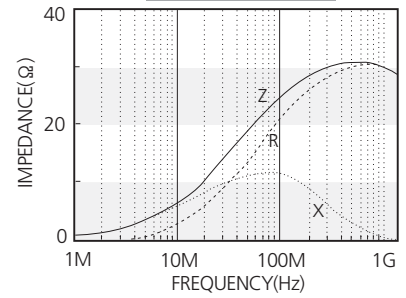

**CIB21P300**

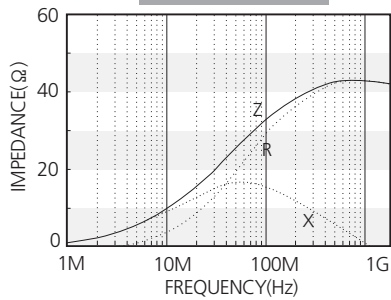

**CIB21P330**

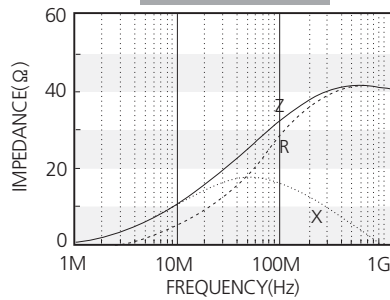

**CIB21P470**

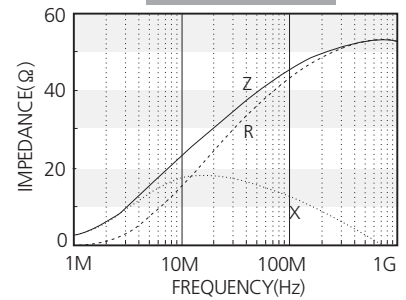

**CIM21U600**

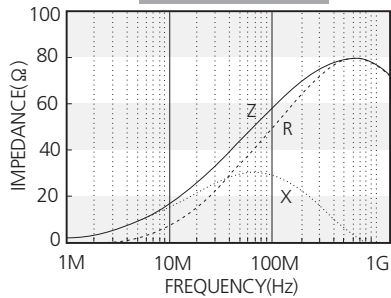

**CIM21U800**

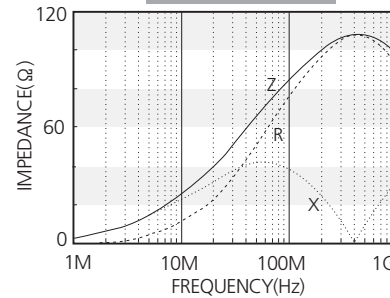

**CIM21U101**

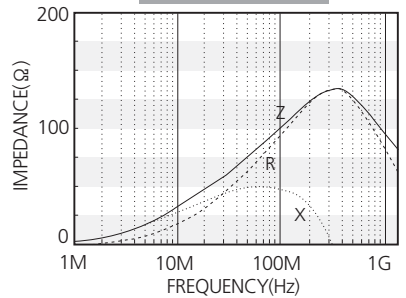

**CIM21U121**

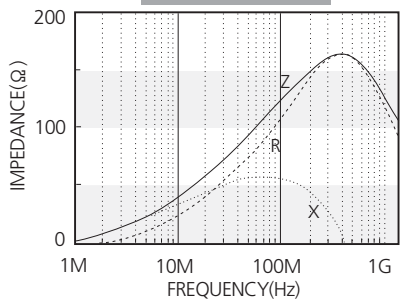

**CIM21U151**

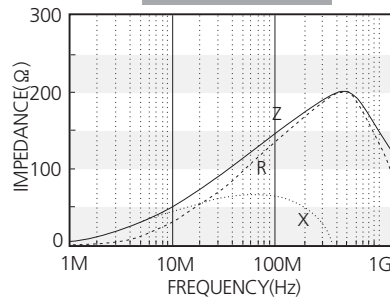

**CIM21U241**

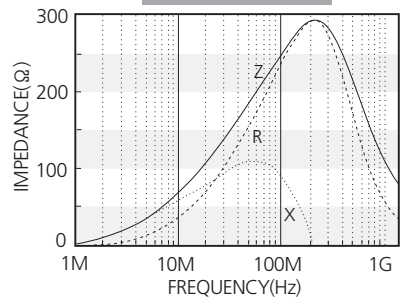

**CIM21U301**

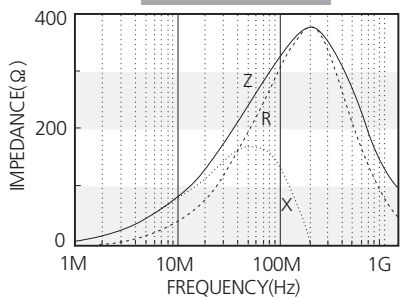

**CIM21U471**

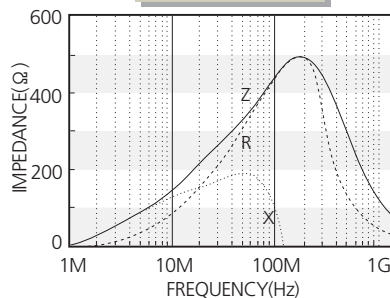

**CIM21U601**

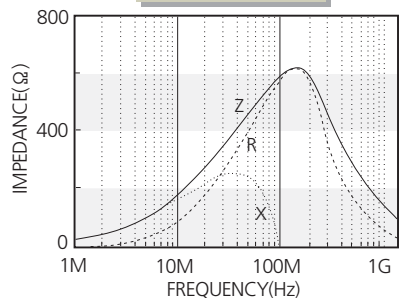

Electrical Characteristics

CIM21U102

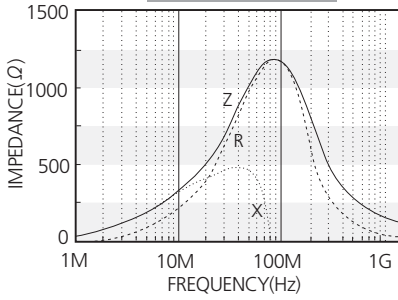

CIM21U202

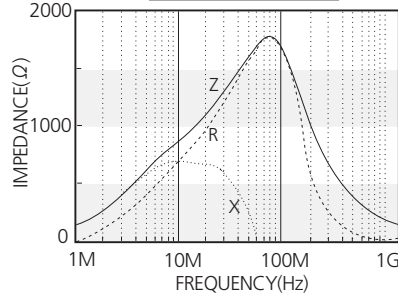

CIB21J260

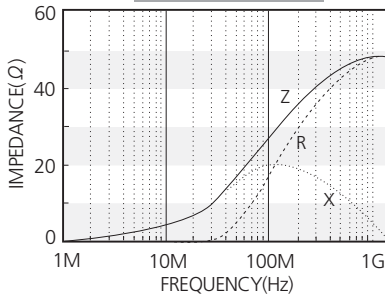

CIB21J300

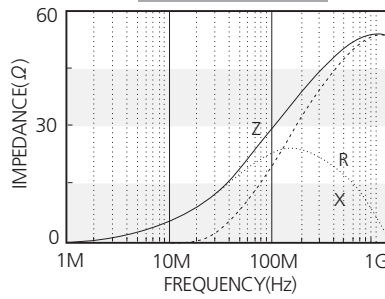

CIB21J400

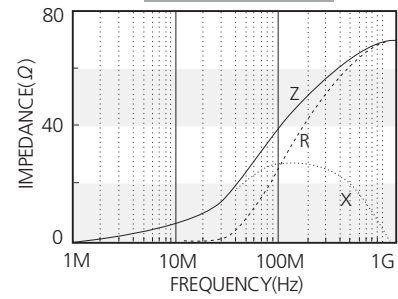

CIM21J600

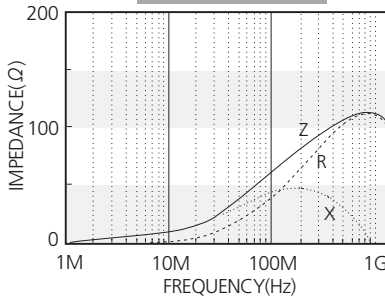

CIM21J800

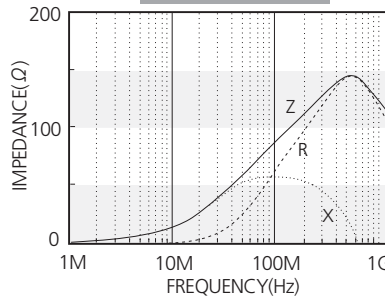

CIM21J121

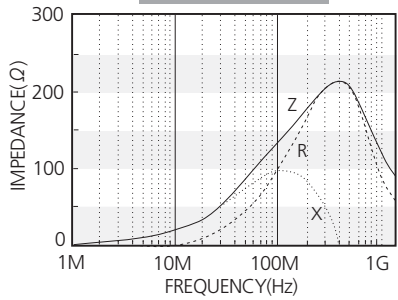

CIM21J151

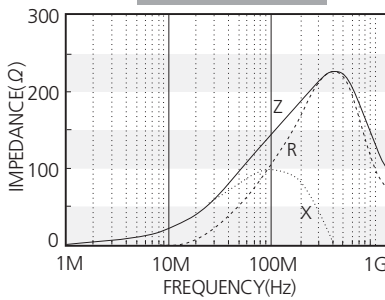

CIM21J221

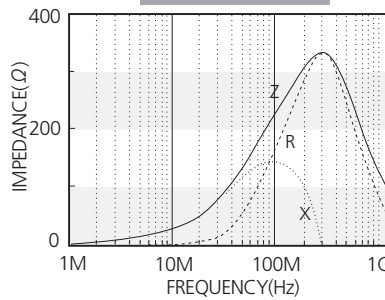

CIM21J241

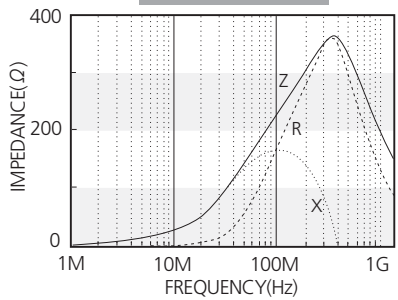

CIM21J301

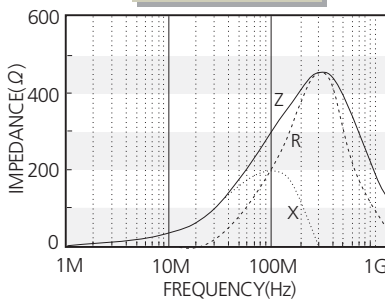

CIM21J471

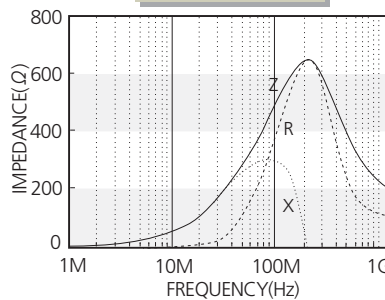

CIM21J601

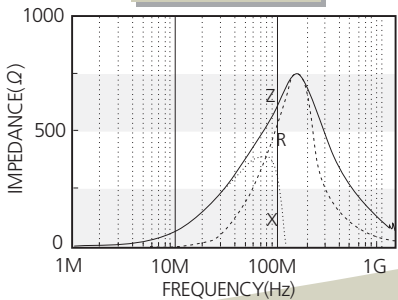

CIB/CIM  
Series

**Electrical Characteristics**

**CIM21J751**

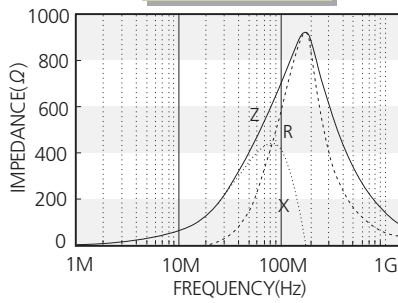

**CIM21J102**

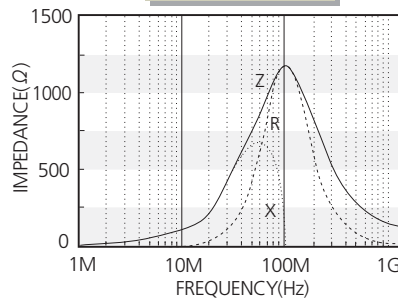

**CIM21J152**

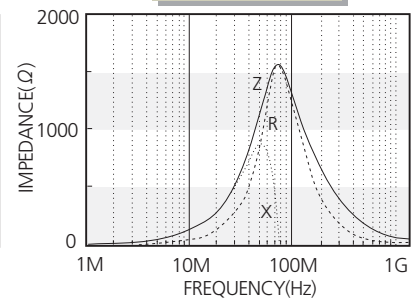

**CIM21J182**

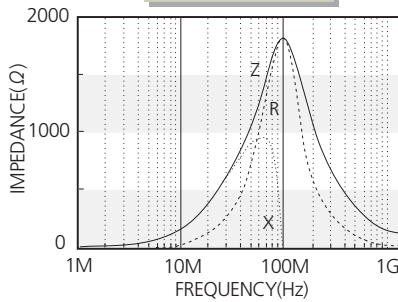

**CIM21J202**

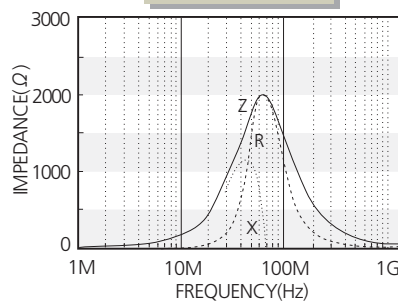

**CIM21J222**

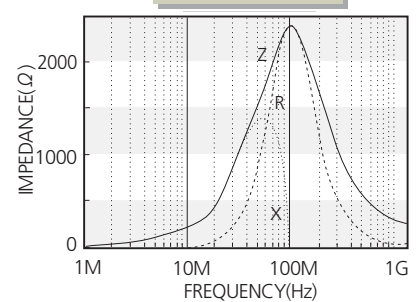

**CIM21J252**

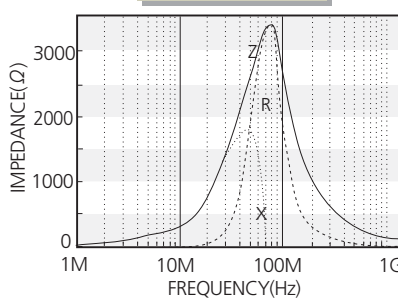

**CIM21K152**

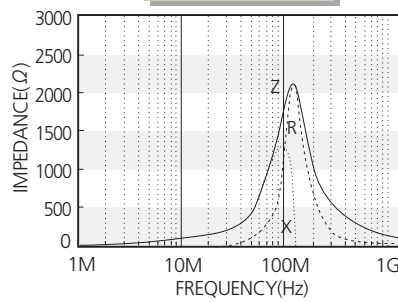

**CIM21K252**

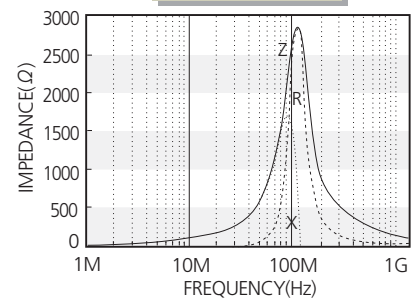

**CIM21N560**

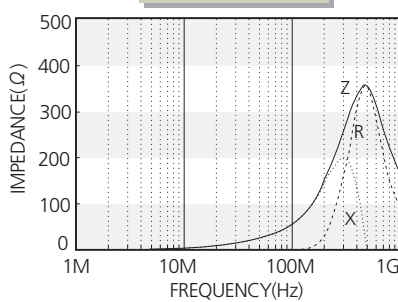

**CIM21N700**

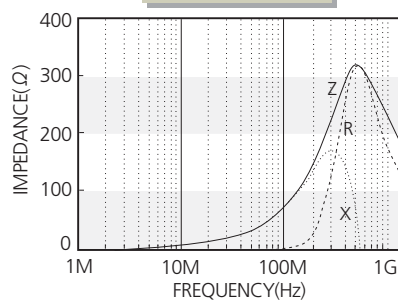

**CIM21N121**

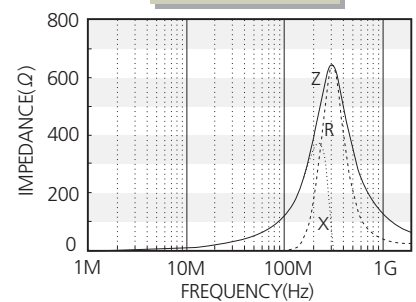

**CIM21N241**

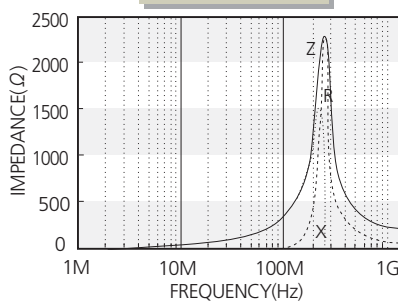

### CIB/CIM 3216(1206) Type

Part No.	Thickness (mm)	Impedance ( $\Omega$ ) $\pm 25\%$ @100 MHz	DC Resistance ( $\Omega$ ) Max.	Rated Current (mA) Max.
CIB 31P 260 N □	1.1 $\pm$ 0.2	26	0.05	2000
CIB 31P 310 N □	1.1 $\pm$ 0.2	31	0.05	2000
CIB 31P 500 N □	1.1 $\pm$ 0.2	50	0.05	2000
CIB 31P 600 N □	1.1 $\pm$ 0.2	60	0.05	1500
CIB 31P 700 N □	1.1 $\pm$ 0.2	70	0.10	1500
CIM 31U 101 N □	1.1 $\pm$ 0.2	100	0.15	500
CIM 31U 601 N □	1.1 $\pm$ 0.2	600	0.30	400
CIM 31J 151 N □	1.1 $\pm$ 0.2	150	0.20	600
CIM 31J 221 N □	1.1 $\pm$ 0.2	220	0.20	600
CIM 31J 301 N □	1.1 $\pm$ 0.2	300	0.25	600
CIM 31J 601 N □	1.1 $\pm$ 0.2	600	0.30	600
CIM 31J 801 N □	1.1 $\pm$ 0.2	800	0.40	500
CIM 31J 102 N □	1.1 $\pm$ 0.2	1000	0.45	500
CIM 31J 152 N □	1.1 $\pm$ 0.2	1500(at 70MHz)	0.55	300

\* Test equipment: Agilent E4991A + 16193A or Equivalent)

### CIB/CIM 3225(1210), 4516(1806) Type

Part No.	Thickness (mm)	Impedance ( $\Omega$ ) $\pm 25\%$ @100 MHz	DC Resistance ( $\Omega$ ) Max.	Rated Current (mA) Max.
CIB 32P 310 N □	1.3 $\pm$ 0.2	31	0.02	3000
CIB 32P 600 N □	1.3 $\pm$ 0.2	60	0.02	1500
CIB 41P 800 N □	1.6 $\pm$ 0.2	80	0.03	1000
CIB 41P 151 N □	1.6 $\pm$ 0.2	150	0.05	1000

Customized products are available.

\* Test equipment: Agilent E4991A + 16193A or Equivalent)

**Electrical Characteristics**

**CIB31P260**

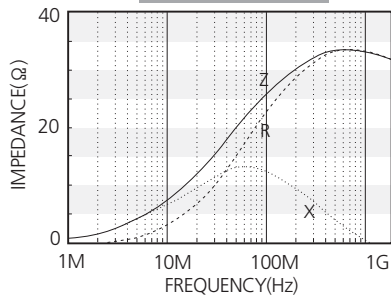

**CIB31P310**

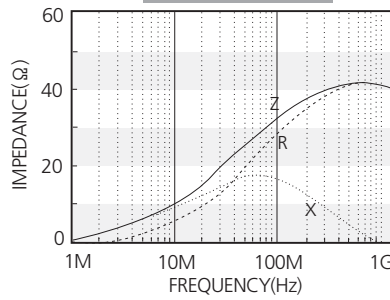

**CIB31P500**

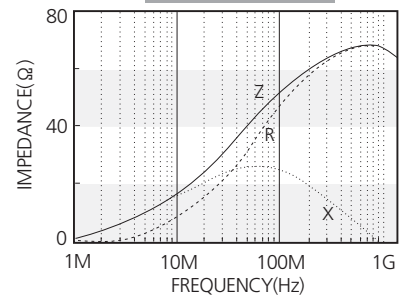

**CIB31P600**

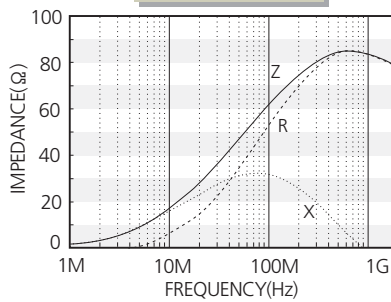

**CIB31P700**

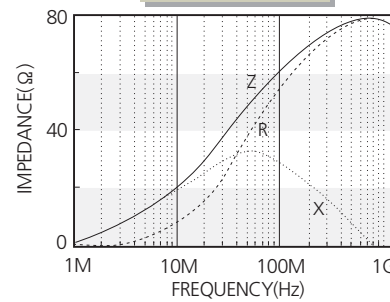

**CIM31U101**

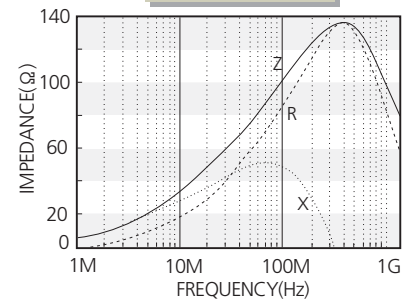

**CIM31U601**

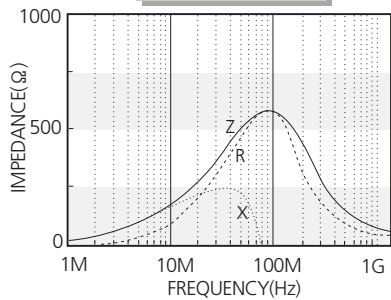

**CIM31J151**

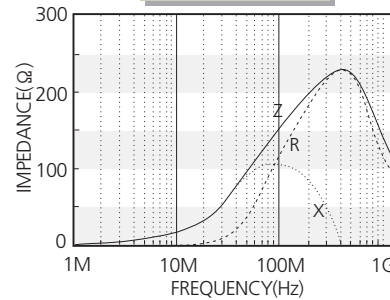

**CIM31J221**

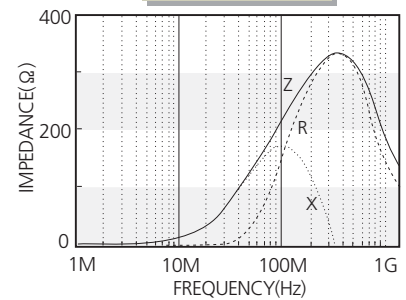

**CIM31J301**

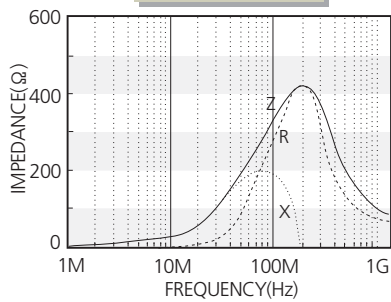

**CIM31J601**

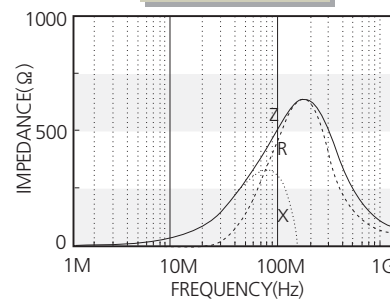

**CIM31J801**

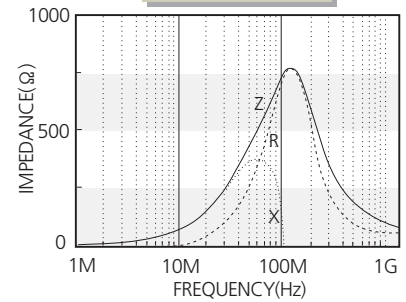

**CIM31J102**

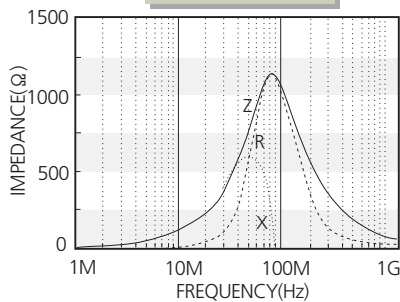

**CIM31J152**

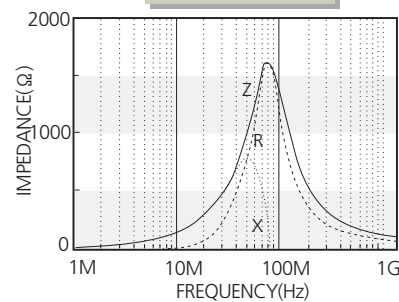



**Electrical Characteristics**

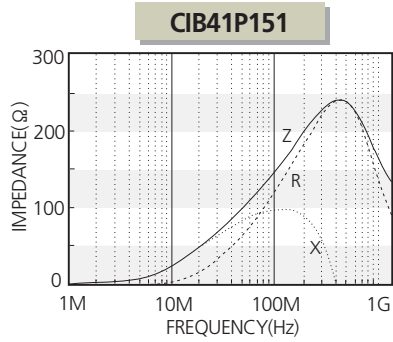
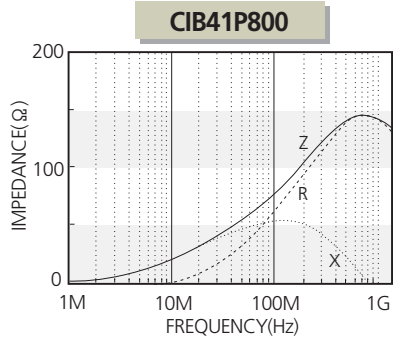
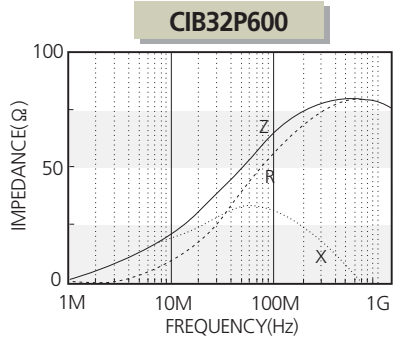
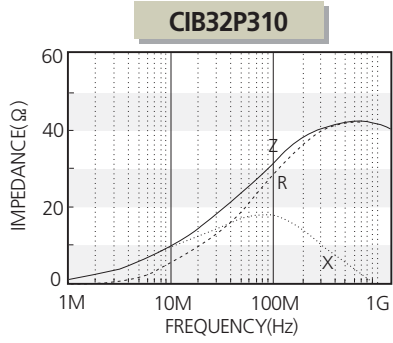

CIB/CIM  
Series

# Chip Bead ; CIC/CIS Series

## For High Current

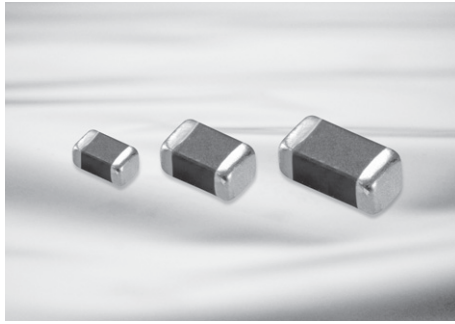

### Feature

- The smallest beads used for high current.

### Application

- Suppression of noise in power line

The CIC/CIS Series can be used in high current owing to their low DC resistance. They can match power lines to a maximum of 6A DC.

Operating Temp	-55~+125°C
Storage Temp (After mounting)	-55~+125°C

### Dimensions

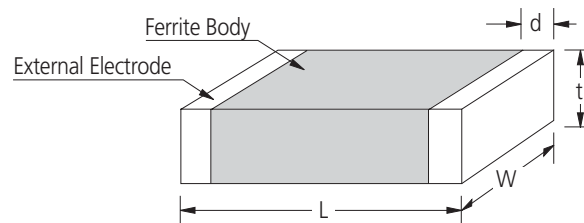

Unit : mm

SIZE CODE	L	W	t	d
02	0.4±0.02	0.2±0.02	0.2±0.02	0.10+0.04,-0.03
03	0.6±0.03	0.3±0.03	0.3±0.03	0.15±0.05
05	1.0±0.05	0.5±0.05	0.5±0.05	0.25±0.1
10	1.6±0.15	0.8±0.15	0.8±0.15/0.6±0.15	0.3±0.2
21	2.0±0.2	1.25±0.2	0.9±0.2	0.5+0.2,-0.3
31	3.2±0.2	1.6±0.2	1.1±0.2	0.5+0.2,-0.3
32	3.2±0.2	2.5±0.2	1.3±0.2	0.5±0.3
41	4.5±0.2	1.6±0.2	1.6±0.2	0.5±0.3

### Part Numbering

**CI**   **C**   **05**   **P**   **300**   **N**   **C**  
 (1)   (2)   (3)   (4)   (5)   (6)   (7)

- (1) Chip Beads
- (2) C: For high current ~3A, S: Ultra high current ~6A
- (3) Dimension
- (4) Material Code(J, P)
- (5) Nominal impedance(310: 31Ω, 121: 120Ω)
- (6) Thickness option(N: Standard, A: Thinner than standard, B: Thicker than standard)
- (7) Packaging(C: paper tape, E: embossed tape)

## CIC/CIS 0402(01005) Type

Part No.	Thickness (mm)	Impedance ( $\Omega$ ) $\pm 25\%$ @100 MHz	DC Resistance ( $\Omega$ ) Max.	Rated Current (mA) Max.
CIC 02U 100 N □	0.20 $\pm$ 0.02	10(typ.)	0.07	750
CIC 02U 700 N □	0.20 $\pm$ 0.02	70	0.37	300
CIC 02U 121 N □	0.20 $\pm$ 0.02	120	0.50	250
CIC 02U 241 N □	0.20 $\pm$ 0.02	240	0.90	200
CIC 02W 100 N □	0.20 $\pm$ 0.02	10(typ.)	0.10	500
CIC 02W 700 N □	0.20 $\pm$ 0.02	70	0.45	260
CIC 02W 121 N □	0.20 $\pm$ 0.02	120	0.60	220
CIC 02W 151 N □	0.20 $\pm$ 0.02	150	0.65	200
CIC 02W 181 N □	0.20 $\pm$ 0.02	180	0.75	200
CIS 02P 100 N □	0.20 $\pm$ 0.02	10(typ.)	0.045	1000

**CIC/CIS 0402(01005) Type**

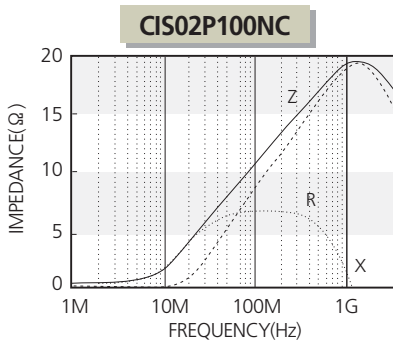
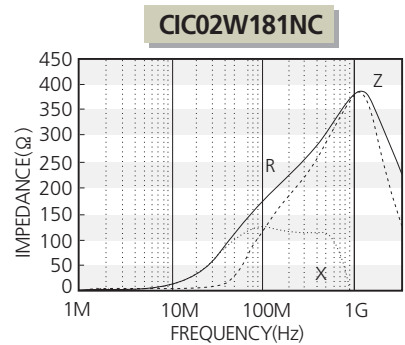
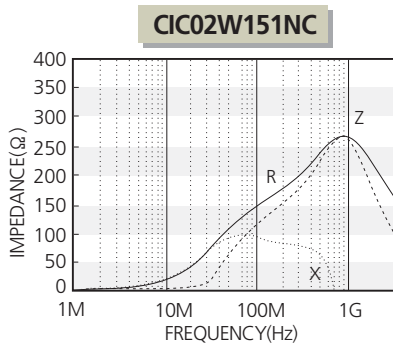
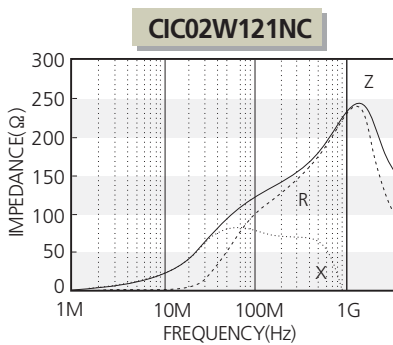
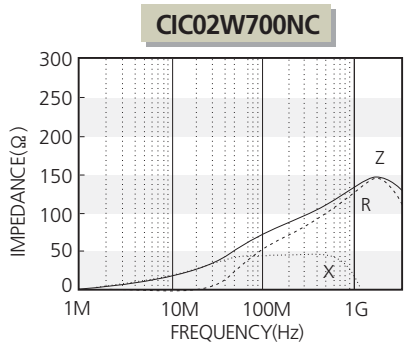
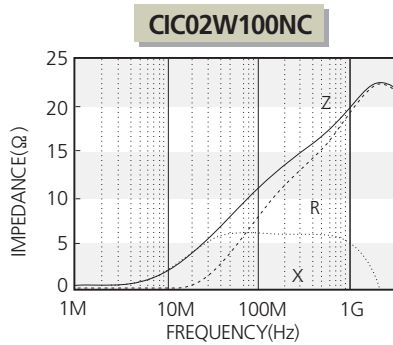
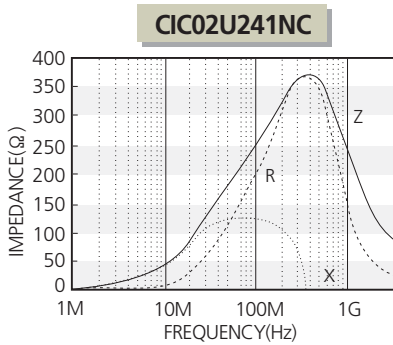
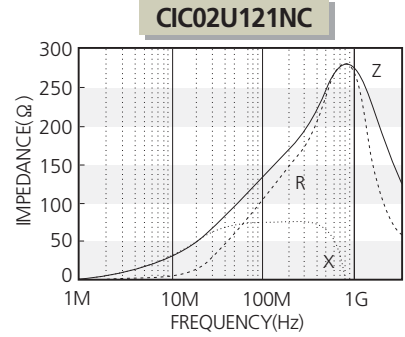
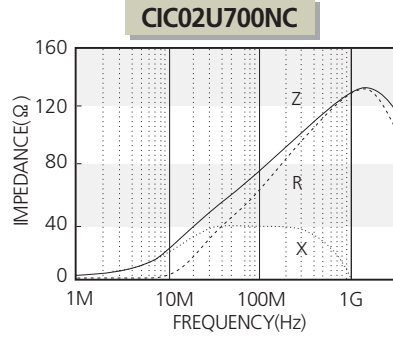
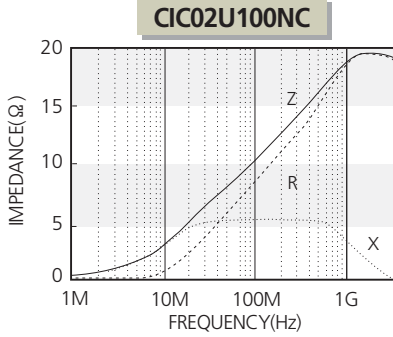

**CIC 0603(0201) Type**

Part No.	Thickness (mm)	Impedance ( $\Omega$ ) $\pm 25\%$ @100 MHz	DC Resistance ( $\Omega$ ) Max.	Rated Current (mA) Max.
CIC 03W 100 N □	0.30 $\pm$ 0.03	10(typ.)	0.05	1000
CIC 03W 800 N □	0.30 $\pm$ 0.03	80	0.18	500
CIC 03W 121 N □	0.30 $\pm$ 0.03	120	0.23	450
CIC 03W 241 N □	0.30 $\pm$ 0.03	240	0.38	350
CIC 03W 601 N □	0.30 $\pm$ 0.03	600	0.85	250
CIC 03W 102 N □	0.30 $\pm$ 0.03	1000	1.25	200

\* Test equipment : Agilent E4991A + 16197A or Equivalent

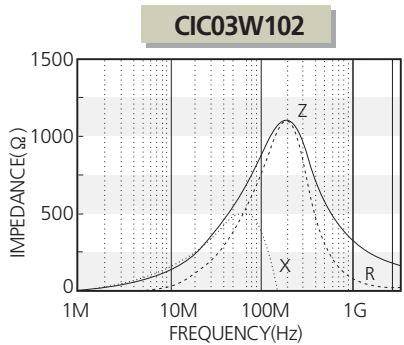
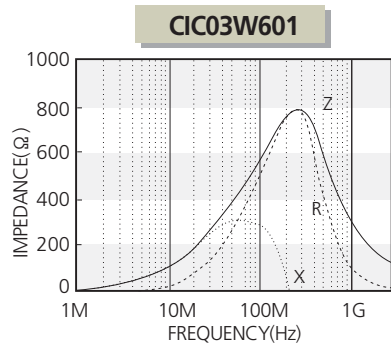
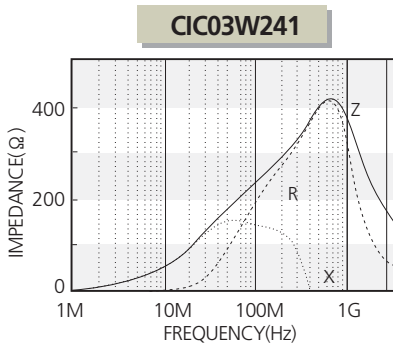
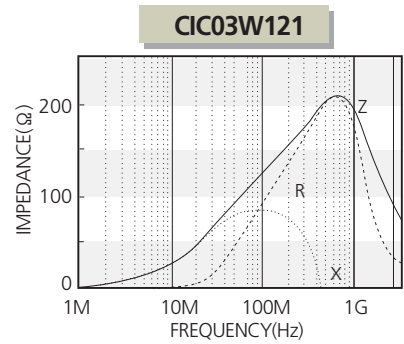
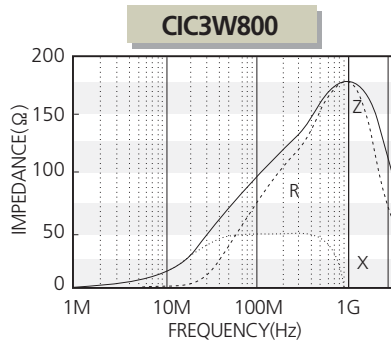
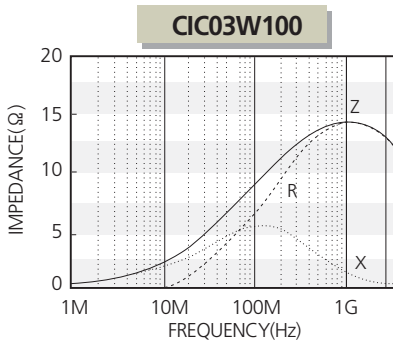

CIC/CIS  
Series

**CIC 1005(0402) Type**

Part No.	Thickness (mm)	Impedance ( $\Omega$ ) $\pm 25\%$ @100 MHz	DC Resistance ( $\Omega$ ) Max.	Rated Current (mA) Max.
CIC05P100 N □	0.50 $\pm$ 0.05	10(typ.)	0.015	1750
CIC05P300 N □	0.50 $\pm$ 0.05	30	0.06	1100
CIC05P700 N □	0.50 $\pm$ 0.05	70	0.10	700
CIC05P121 N □	0.50 $\pm$ 0.05	120	0.13	700
CIC05P221 N □	0.50 $\pm$ 0.05	220	0.18	600
CIC05P471 N □	0.50 $\pm$ 0.05	470	0.30	500
CIC05P601 N □	0.50 $\pm$ 0.05	600	0.34	420
CIC05P102 N □	0.50 $\pm$ 0.05	1000	0.49	350
CIC05J 600 N □	0.50 $\pm$ 0.05	60	0.09	1500
CIC05Y100 N □	0.50 $\pm$ 0.05	10(typ.)	0.035	2200
CIC05Y300 N □	0.50 $\pm$ 0.05	30	0.035	2200
CIC05Y600 N □	0.50 $\pm$ 0.05	60	0.06	1700
CIC05Y800 N □	0.50 $\pm$ 0.05	80	0.07	1500
CIC05Y101 N □	0.50 $\pm$ 0.05	100	0.07	1500
CIC05Y121 N □	0.50 $\pm$ 0.05	120	0.09	1300

\* Test equipment : Agilent E4991A + 16192A or Equivalent

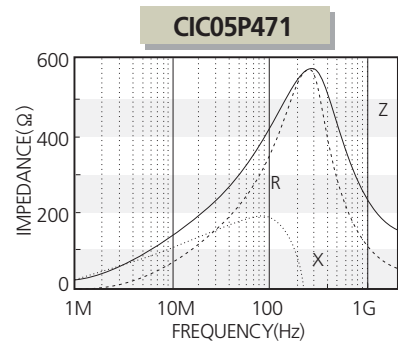
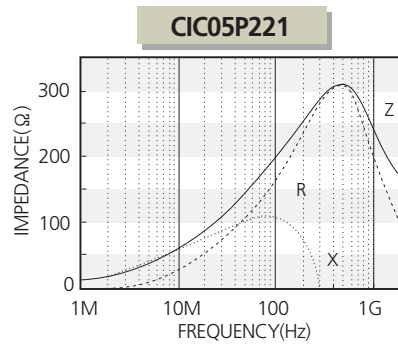
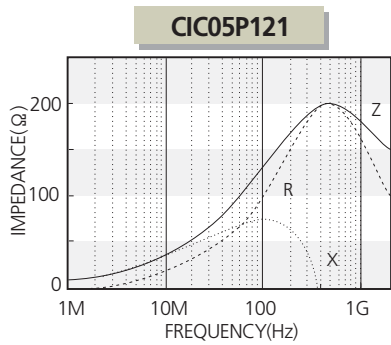
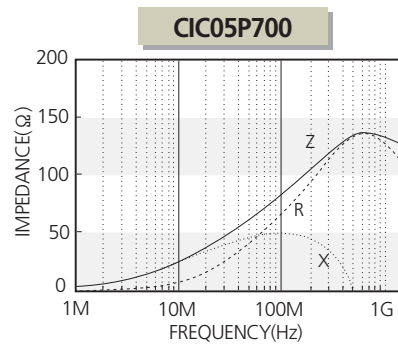
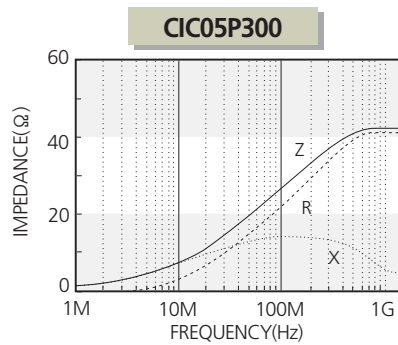
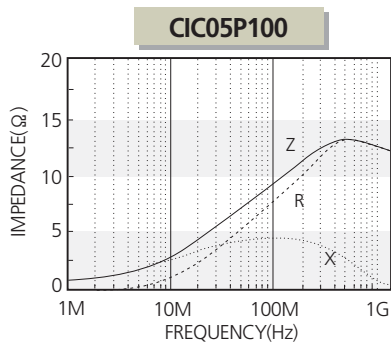

CIC 1005(0402) Type

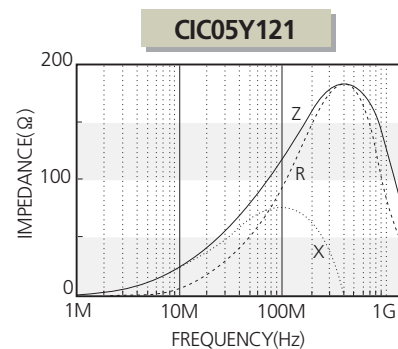
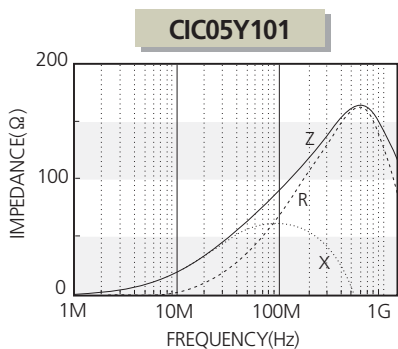
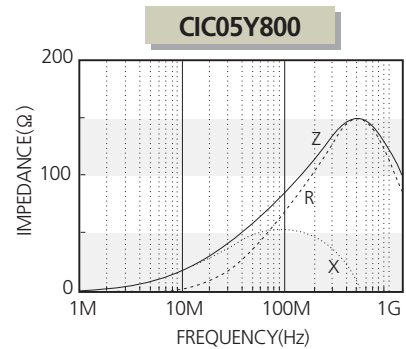
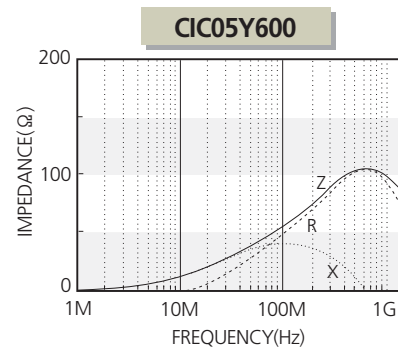
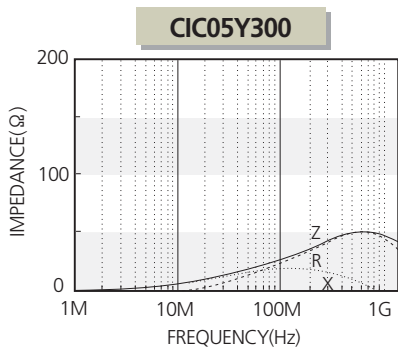
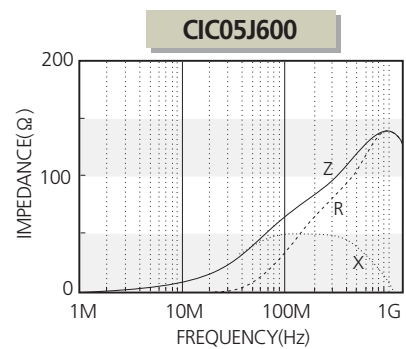
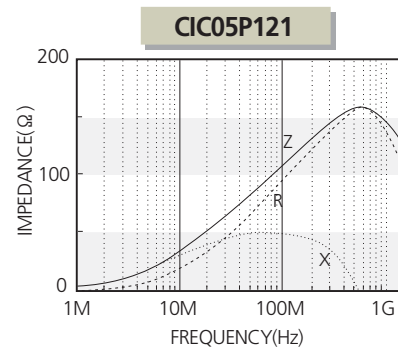
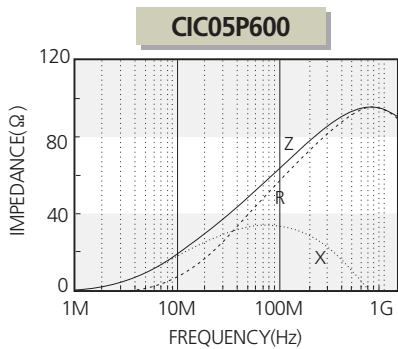
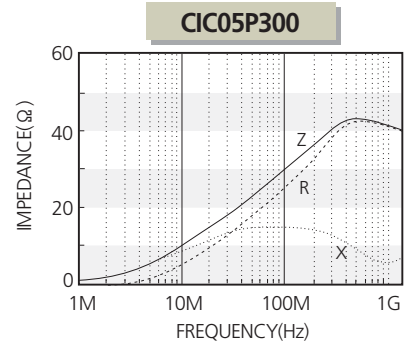
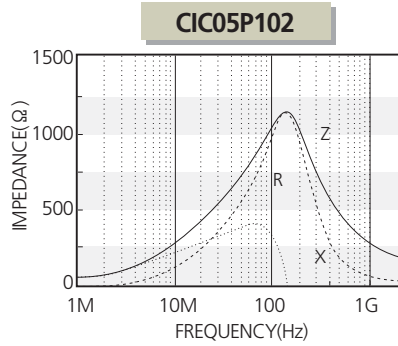
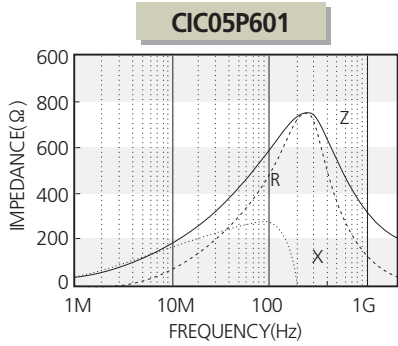

CIC/CIS  
Series



### CIC 1608(0603) Type

Part No.	Thickness (mm)	Impedance ( $\Omega$ ) $\pm 25\%$ @100 MHz	DC Resistance ( $\Omega$ ) Max.	Rated Current (mA) Max.
CIC 10P 080 N □	0.8 $\pm$ 0.15	8(typ.)	0.03	3000
CIC 10P 220 N □	0.8 $\pm$ 0.15	22	0.025	3000
CIC 10P 300 N □	0.8 $\pm$ 0.15	30	0.025	3000
CIC 10P 330 N □	0.8 $\pm$ 0.15	33	0.025	3000
CIC 10P 600 N □	0.8 $\pm$ 0.15	60	0.05	2500
CIC 10P 800 N □	0.8 $\pm$ 0.15	80	0.05	2000
CIC 10P 101 N □	0.8 $\pm$ 0.15	100	0.05	2000
CIC 10P 121 N □	0.8 $\pm$ 0.15	120	0.05	2000
CIC 10P 151 N □	0.8 $\pm$ 0.15	150	0.09	1500
CIC 10P 181 N □	0.8 $\pm$ 0.15	180	0.09	1500
CIC 10P 221 N □	0.8 $\pm$ 0.15	220	0.10	1400
CIC 10P 301 N □	0.8 $\pm$ 0.15	300	0.12	1200
CIC 10P 331 N □	0.8 $\pm$ 0.15	330	0.14	1200
CIC 10P 471 N □	0.8 $\pm$ 0.15	470	0.15	1200
CIC 10P 601 N □	0.8 $\pm$ 0.15	600	0.15	1200
CIC 10J 080 N □	0.8 $\pm$ 0.15	8(typ.)	0.02	3000
CIC 10J 300 N □	0.8 $\pm$ 0.15	30	0.03	3000
CIC 10J 470 N □	0.8 $\pm$ 0.15	47	0.05	2000
CIC 10J 600 N □	0.8 $\pm$ 0.15	60	0.05	2000
CIC 10J 800 N □	0.8 $\pm$ 0.15	80	0.10	2000
CIC 10J 121 N □	0.8 $\pm$ 0.15	120	0.10	2000
CIC 10J 151 N □	0.8 $\pm$ 0.15	150	0.15	1500
CIC 10J 221 N □	0.8 $\pm$ 0.15	220	0.15	1500
CIC 10J 301 N □	0.8 $\pm$ 0.15	300	0.15	800
CIC 10J 471 N □	0.8 $\pm$ 0.15	470	0.15	800
CIC 10J 601 N □	0.8 $\pm$ 0.15	600	0.15	750

※ Test equipment: Agilent E4991A + 16193A or Equivalent



Electrical Characteristics

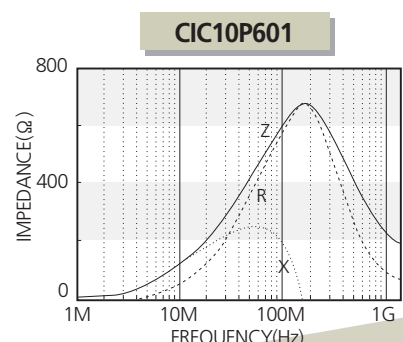
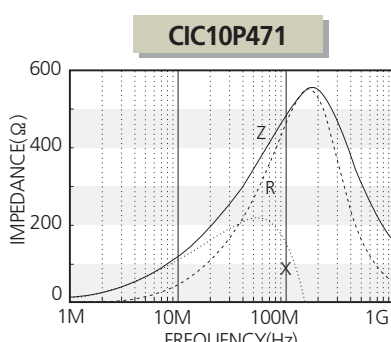
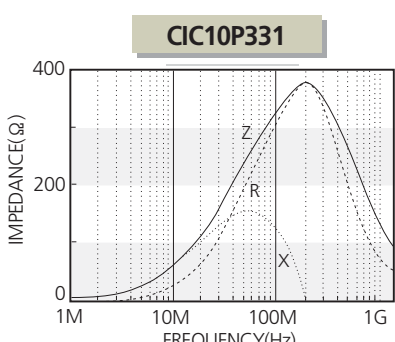
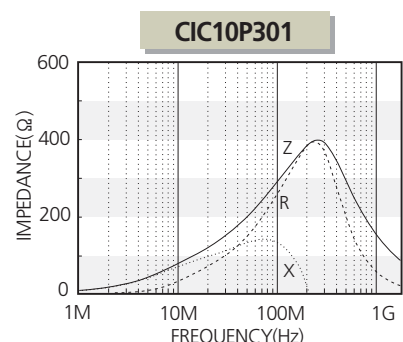
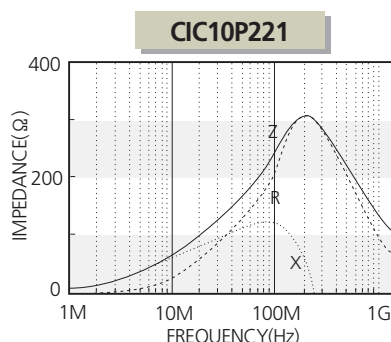
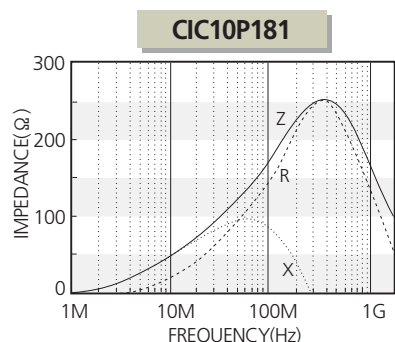
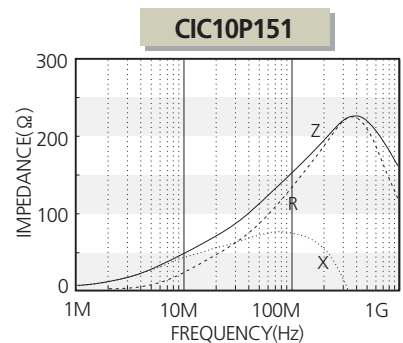
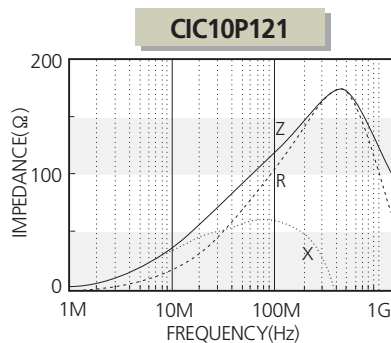
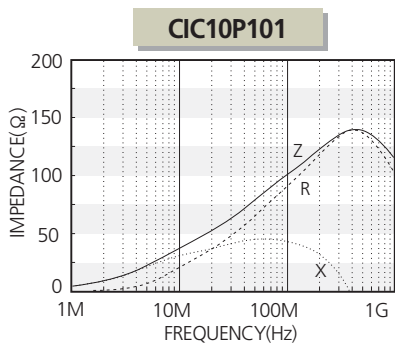
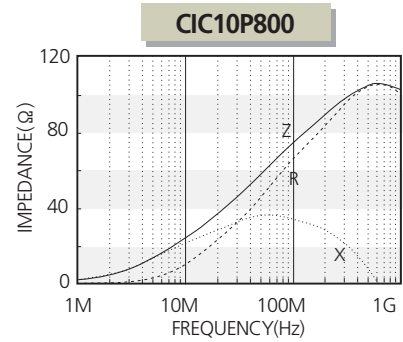
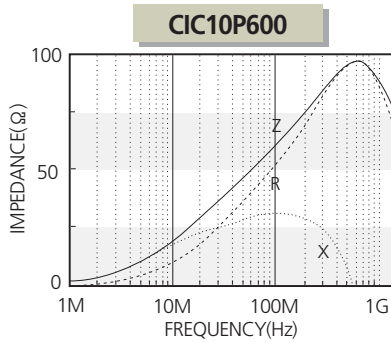
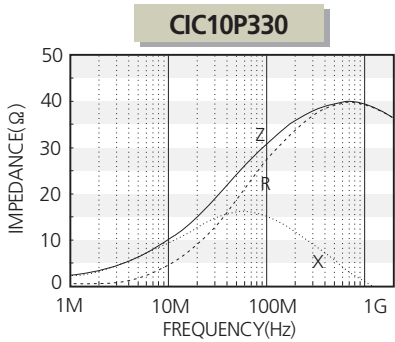
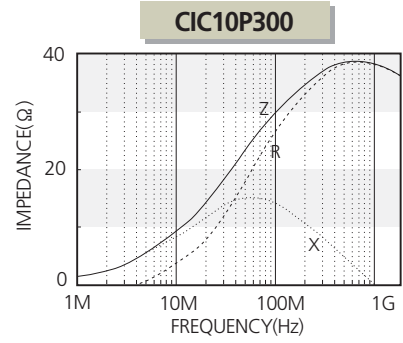
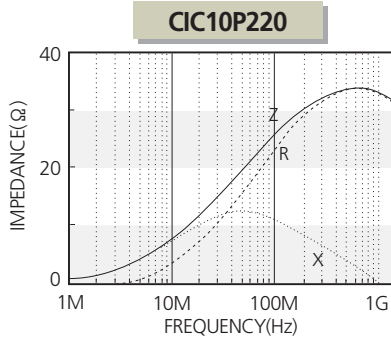
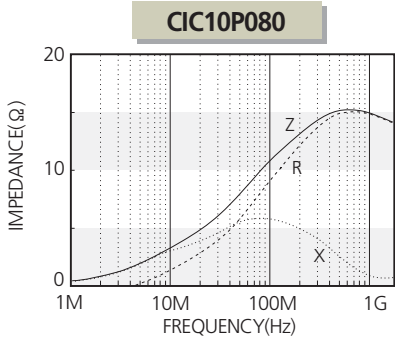

CIC/CIS  
Series

## Electrical Characteristics

**CIC10J080**

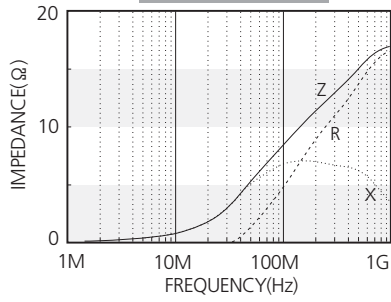

**CIC10J300**

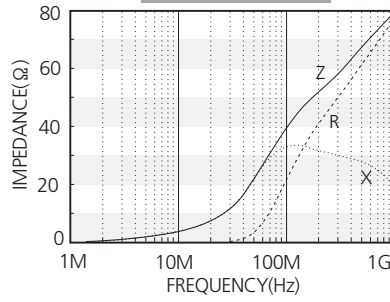

**CIC10J470**

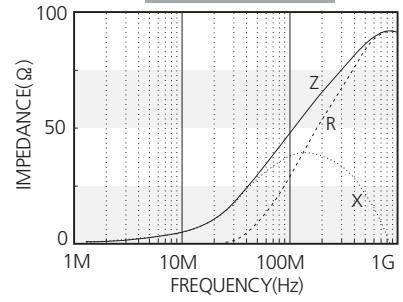

**CIC10J600**

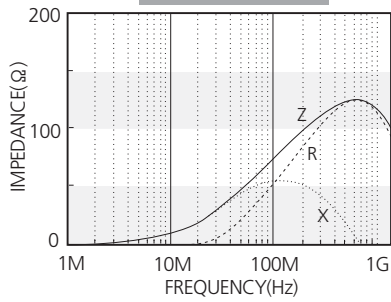

**CIC10J800**

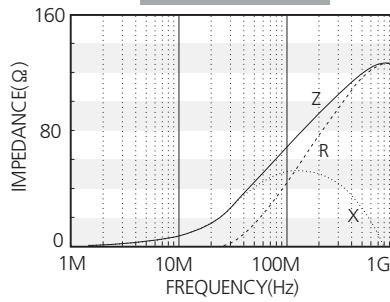

**CIC10J121**

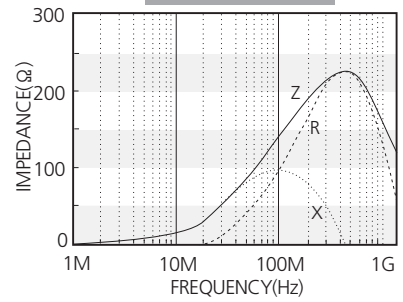

**CIC10J151**

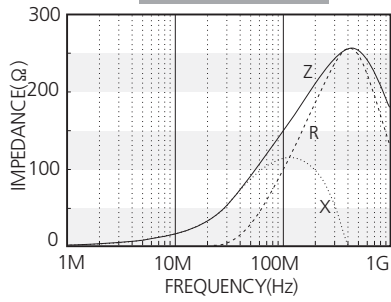

**CIC10J221**

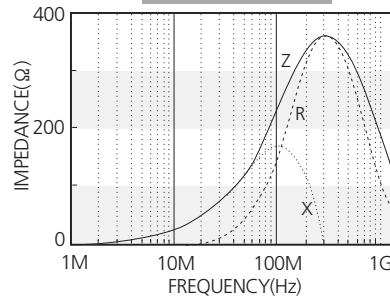

**CIC10J301**

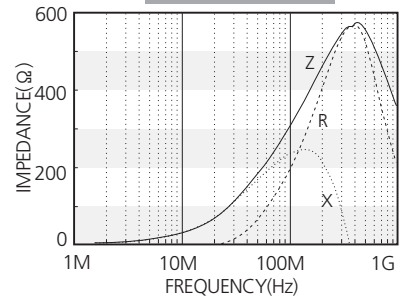

**CIC10J471**

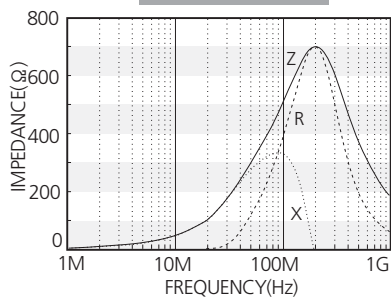

**CIC10J601**

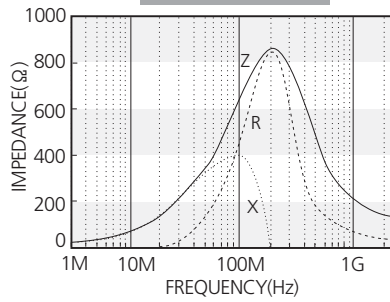

**CIC 2012(0805) Type**

Part No.	Thickness (mm)	Impedance ( $\Omega$ ) $\pm 25\%$ @100 MHz	DC Resistance ( $\Omega$ ) Max.	Rated Current (mA) Max.
CIC 21P 110 N □	0.90 $\pm$ 0.2	11(typ.)	0.05	6000
CIC 21P 300 N □	0.90 $\pm$ 0.2	30	0.015	3000
CIC 21P 600 N □	0.90 $\pm$ 0.2	60	0.025	3000
CIC 21P 800 N □	0.90 $\pm$ 0.2	80	0.025	2500
CIC 21P 101 N □	0.90 $\pm$ 0.2	100	0.02	2000
CIC 21P 121 N □	0.90 $\pm$ 0.2	120	0.05	2000
CIC 21P 221 N □	0.90 $\pm$ 0.2	220	0.035	3200
CIC 21P 331 N □	0.85 $\pm$ 0.2	330	0.05	2000
CIC 21P 601 N □	0.90 $\pm$ 0.2	600	0.15	1000
CIC 21J 600 N □	0.90 $\pm$ 0.2	60	0.03	3800
CIC 21J 121 N □	0.90 $\pm$ 0.2	120	0.05	2500
CIC 21J 221 N □	0.90 $\pm$ 0.2	220	0.05	1500
CIC 21J 301 N □	0.90 $\pm$ 0.2	300	0.10	1500
CIC 21J 471 N □	0.90 $\pm$ 0.2	470	0.08	1500
CIC 21J 601 N □	0.90 $\pm$ 0.2	600	0.10	1000

\* Test equipment: Agilent E4991A + 16193A or Equivalent



**CIC 3216(1206) Type**

Part No.	Thickness (mm)	Impedance ( $\Omega$ ) $\pm 25\%$ @100 MHz	DC Resistance ( $\Omega$ ) Max.	Rated Current (mA) Max.
CIC 31P 260 N □	1.1 $\pm$ 0.2	26	0.01	6000
CIC 31P 300 N □	1.1 $\pm$ 0.2	30	0.01	6000
CIC 31P 310 N □	1.1 $\pm$ 0.2	31	0.01	6000
CIC 31P 330 N □	1.1 $\pm$ 0.2	33	0.01	6000
CIC 31P 350 N □	1.1 $\pm$ 0.2	35	0.025	3000
CIC 31P 500 N □	1.1 $\pm$ 0.2	50	0.025	3000
CIC 31P 520 N □	1.1 $\pm$ 0.2	52	0.025	3000
CIC 31P 600 N □	1.1 $\pm$ 0.2	60	0.025	3000
CIC 31P 680 N □	1.1 $\pm$ 0.2	68	0.025	3000
CIC 31P 700 N □	1.1 $\pm$ 0.2	70	0.025	3000
CIC 31P 800 N □	1.1 $\pm$ 0.2	80	0.025	3000
CIC 31P 900 N □	1.1 $\pm$ 0.2	90	0.025	2000
CIC 31P 121 N □	1.1 $\pm$ 0.2	120	0.025	2000
CIC 31P 151 N □	1.1 $\pm$ 0.2	150	0.05	2000
CIC 31P 221 N □	1.1 $\pm$ 0.2	220	0.05	2000
CIC 31P 301 N □	1.1 $\pm$ 0.2	300	0.05	2000
CIC 31P 391 N □	1.1 $\pm$ 0.2	390	0.05	2000
CIC 31P 471 N □	1.1 $\pm$ 0.2	470	0.07	1500
CIC 31P 601 N □	1.1 $\pm$ 0.2	600	0.07	1500
CIC 31J 300 N □	1.1 $\pm$ 0.2	30	0.02	4000
CIC 31J 500 N □	1.1 $\pm$ 0.2	50	0.02	4000
CIC 31J 680 N □	1.1 $\pm$ 0.2	68	0.02	4000
CIC 31J 800 N □	1.1 $\pm$ 0.2	80	0.02	4000
CIC 31J 900 N □	1.1 $\pm$ 0.2	90	0.02	4000
CIC 31J 121 N □	1.1 $\pm$ 0.2	120	0.03	4000
CIC 31J 151 N □	1.1 $\pm$ 0.2	150	0.03	3000
CIC 31J 241 N □	1.1 $\pm$ 0.2	240	0.05	3000
CIC 31J 301 N □	1.1 $\pm$ 0.2	300	0.05	3000
CIC 31J 471 N □	1.1 $\pm$ 0.2	470	0.05	3000
CIC 31J 501 N □	1.1 $\pm$ 0.2	500	0.05	3000
CIC 31J 601 N □	1.1 $\pm$ 0.2	600	0.05	2500

\* Test equipment : Agilent E4991A + 16193A or Equivalent

CIC/CIS  
Series

## Electrical Characteristics

**CIC31P260**

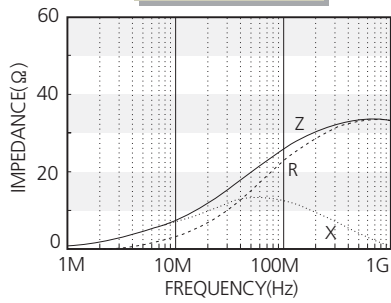

**CIC31P300**

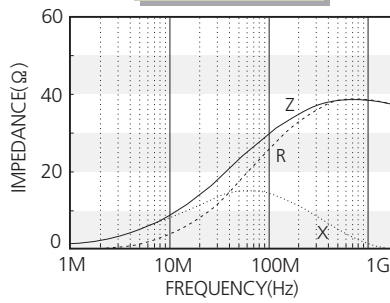

**CIC31P310**

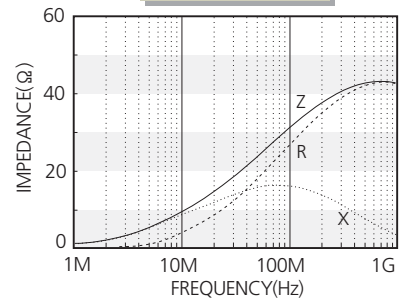

**CIC31P330**

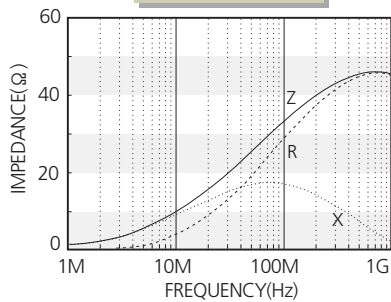

**CIC31P350**

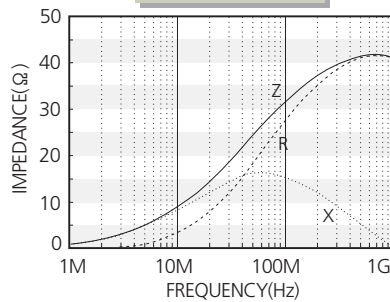

**CIC31P500**

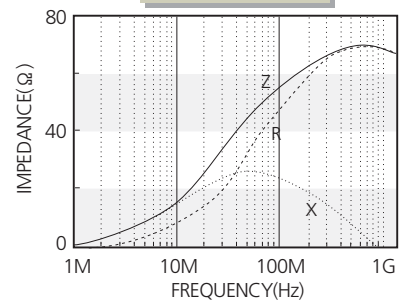

**CIC31P520**

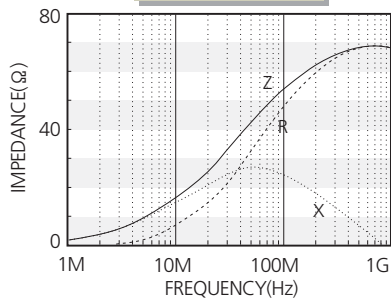

**CIC31P600**

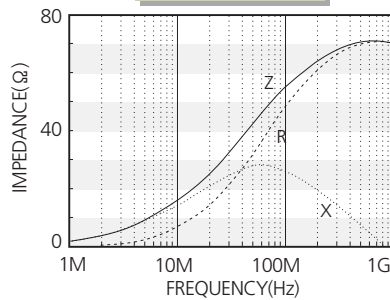

**CIC31P680**

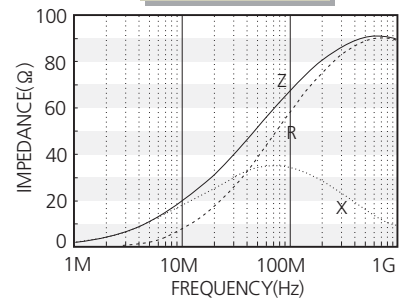

**CIC31P121**

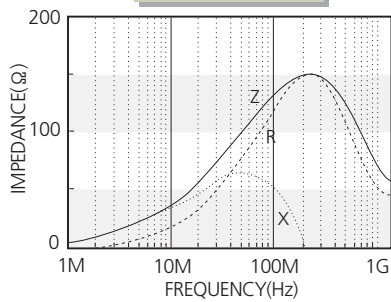

**CIC31P151**

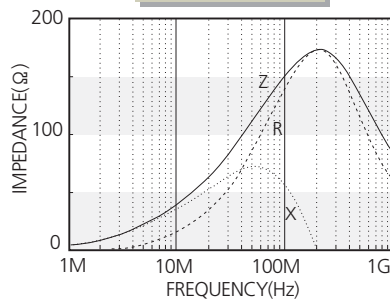

**CIC31P221**

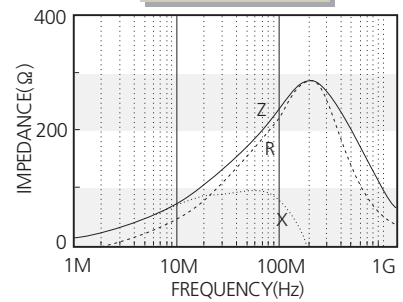

**CIC31P301**

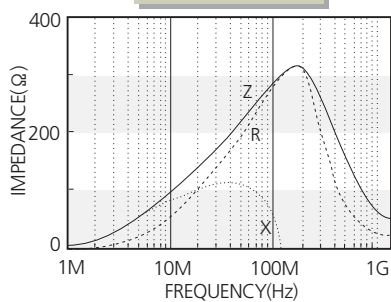

**CIC31P471**

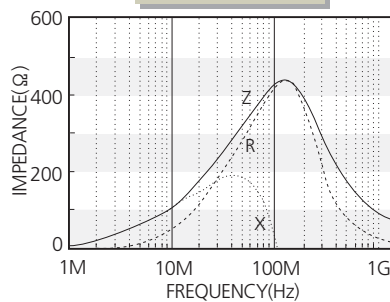

**CIC31P601**

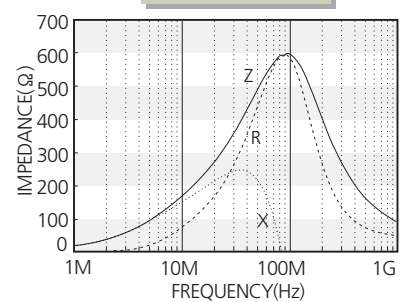

Electrical Characteristics

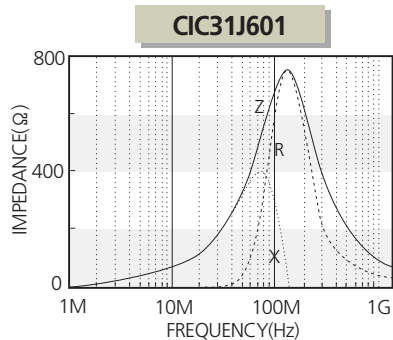
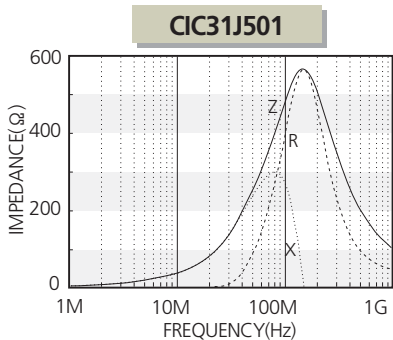
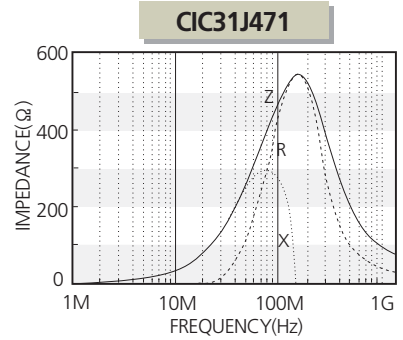
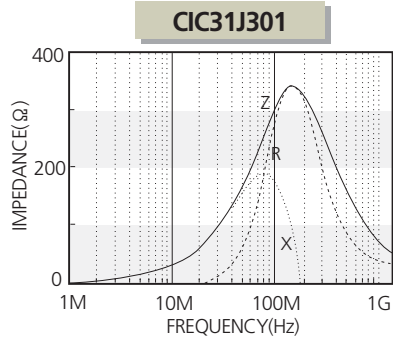
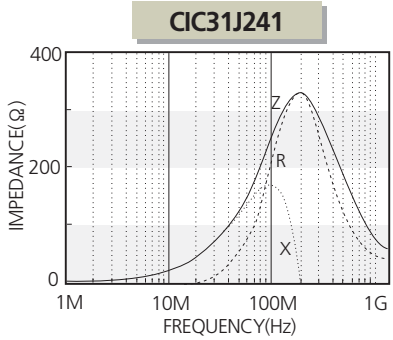
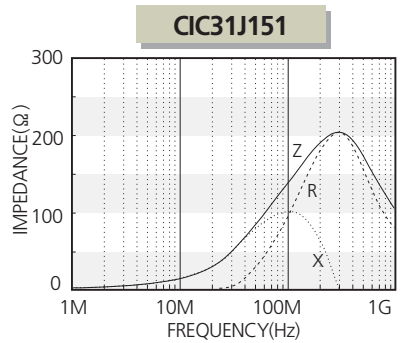
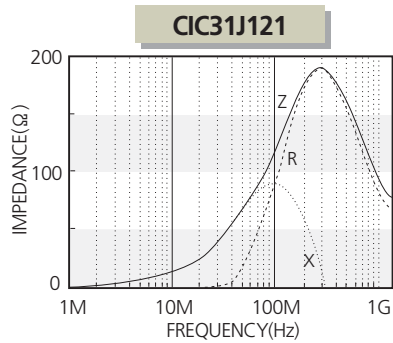
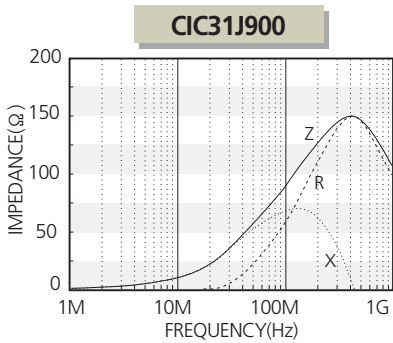
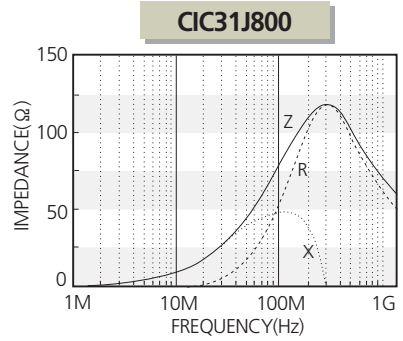
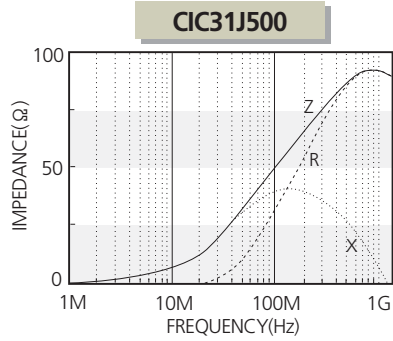
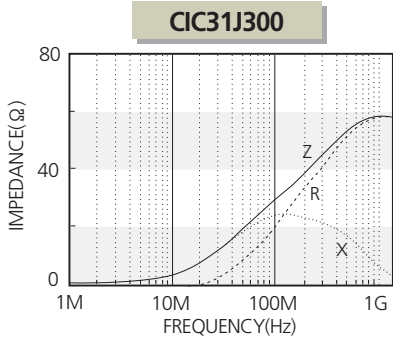

CIC/CIS  
Series



### CIC 4516(1806) Type

Part No.	Thickness (mm)	Impedance ( $\Omega$ ) $\pm 25\%$ @100 MHz	DC Resistance ( $\Omega$ ) Max.	Rated Current (mA) Max.
CIC 41P 260 N□	1.6 $\pm$ 0.2	26(typ.)	0.01	6000
CIC 41P 600 N□	1.6 $\pm$ 0.2	60	0.01	6000
CIC 41P 750 N□	1.6 $\pm$ 0.2	75	0.01	6000
CIC 41P 800 N□	1.6 $\pm$ 0.2	80	0.01	6000
CIC 41P 910 N□	1.6 $\pm$ 0.2	91	0.025	3000
CIC 41P 111 N□	1.6 $\pm$ 0.2	110	0.025	3000
CIC 41P 121 N□	1.6 $\pm$ 0.2	120	0.025	3000
CIC 41P 151 N□	1.6 $\pm$ 0.2	150	0.025	3000
CIC 41P 181 N□	1.6 $\pm$ 0.2	180	0.025	3000
CIC 41P 221 N□	1.6 $\pm$ 0.2	220	0.05	2000
CIC 41P 301 N□	1.6 $\pm$ 0.2	300	0.05	2000
CIC 41P 471 N□	1.6 $\pm$ 0.2	470	0.05	2000
CIC 41P 601 N□	1.6 $\pm$ 0.2	600	0.08	1500
CIC 41J 260 N□	1.6 $\pm$ 0.2	26(typ.)	0.01	6000
CIC 41J 400 N□	1.6 $\pm$ 0.2	40	0.01	6000
CIC 41J 600 N□	1.6 $\pm$ 0.2	60	0.01	6000
CIC 41J 800 N□	1.6 $\pm$ 0.2	80	0.01	6000
CIC 41J 910 N□	1.6 $\pm$ 0.2	91	0.02	6000
CIC 41J 121 N□	1.6 $\pm$ 0.2	120	0.03	3000
CIC 41J 151 N□	1.6 $\pm$ 0.2	150	0.03	3000
CIC 41J 221 N□	1.6 $\pm$ 0.2	220	0.04	2500
CIC 41J 301 N□	1.6 $\pm$ 0.2	300	0.04	2500
CIC 41J 471 N□	1.6 $\pm$ 0.2	470	0.04	2500
CIC 41J 601 N□	1.6 $\pm$ 0.2	600	0.04	2500

※ Test equipment: Agilent E4991A + 16193A or Equivalent



Electrical Characteristics

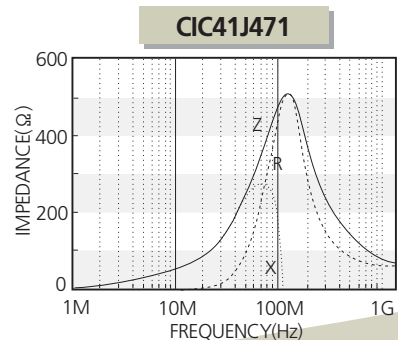
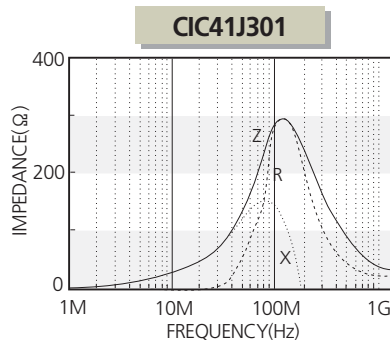
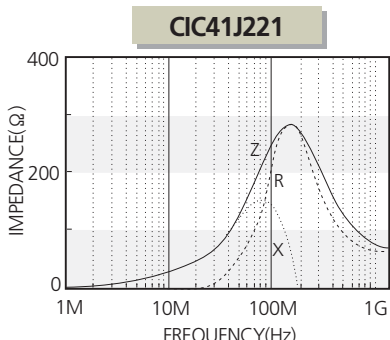
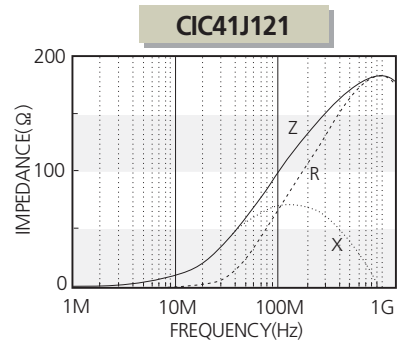
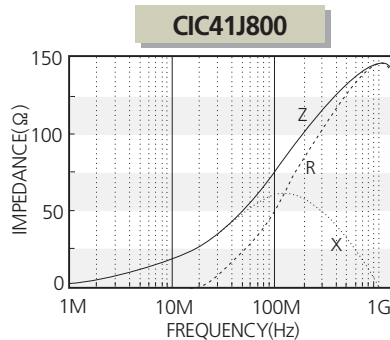
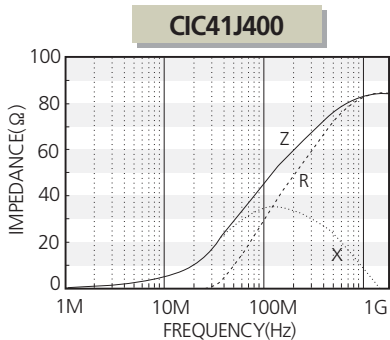
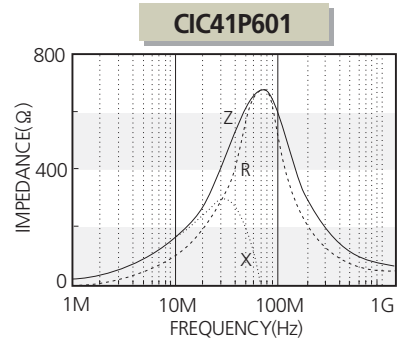
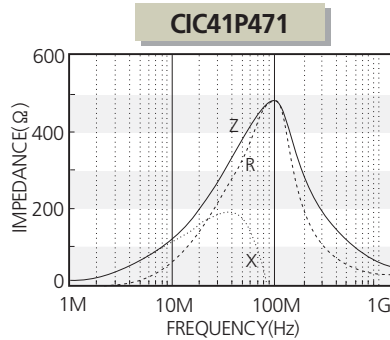
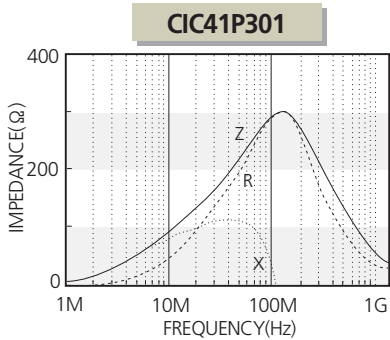
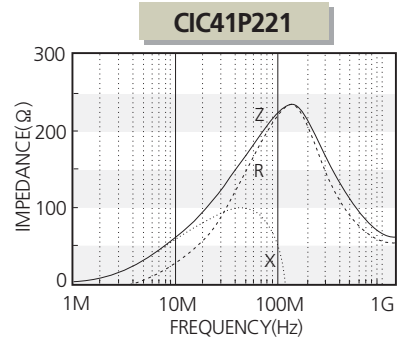
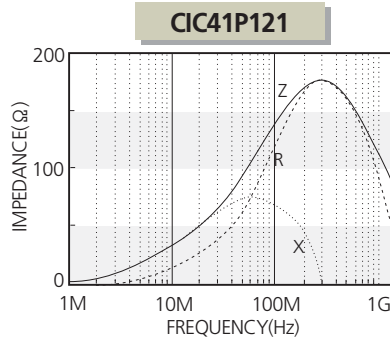
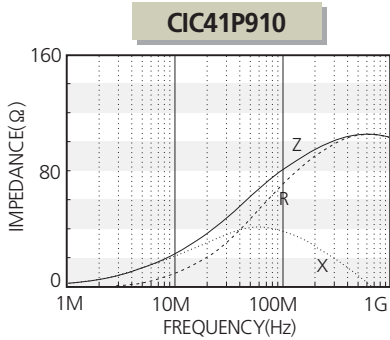
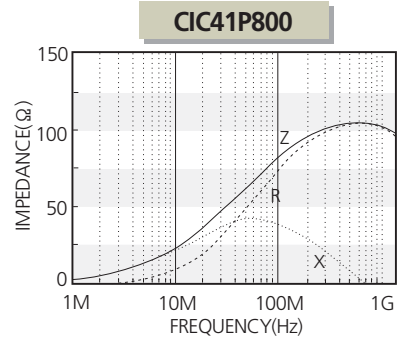
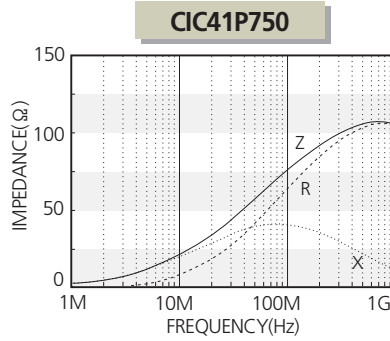
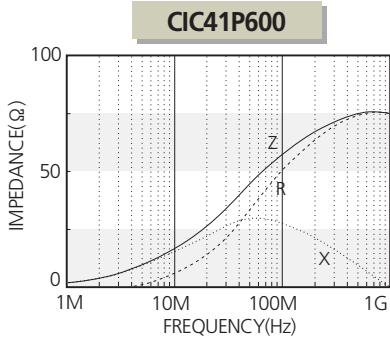

CIC/CIS  
Series



## Electrical Characteristics

CIC41J601

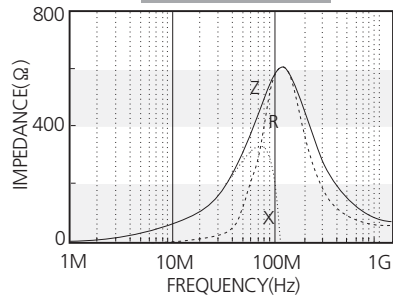

**CIS Series**

Part No.	Thickness (mm)	Impedance ( $\Omega$ ) $\pm 25\%$ @100 MHz	DC Resistance ( $\Omega$ ) Max.	Rated Current (mA) Max.
CIS 10P 260 A □	0.6 ± 0.15	26	0.007	6000
CIS 10P 300 A □	0.6 ± 0.15	30	0.01	6000
CIS 10P 700 A □	0.6 ± 0.15	70	0.02	4000
CIS 10P 101 A □	0.6 ± 0.15	100	0.03	3000
CIS 10P 121 A □	0.6 ± 0.15	120	0.03	3000
CIS 10P 181 A □	0.6 ± 0.15	180	0.04	2500
CIS 10P 221 N □	0.8 ± 0.15	220	0.05	2500
CIS 10P 301 N □	0.8 ± 0.15	300	0.07	2000
CIS 10P 331 N □	0.8 ± 0.15	330	0.07	1700
CIS 10P 391 N □	0.8 ± 0.15	390	0.10	1200
CIS 10P 471 N □	0.8 ± 0.15	470	0.13	1500
CIS 10P 601 N □	0.8 ± 0.15	600	0.15	1300
CIS 10J 300 N □	0.8 ± 0.15	30	0.01	6000
CIS 21P 300 N □	0.9 ± 0.2	30	0.01	6000
CIS 21P 101 N □	0.9 ± 0.2	100	0.02	4000
CIS 21J 121 N □	0.9 ± 0.2	120	0.02	5000
CIS 32P 520 N □	1.3 ± 0.2	52	0.01	6000
CIS 41P 600 N □	1.6 ± 0.2/1.2 ± 0.2	60	0.01	6000
CIS 41J 600 N □	1.6 ± 0.2/1.2 ± 0.2	60	0.01	6000

\* Test equipment : Agilent E4991A + 16193A or Equivalent

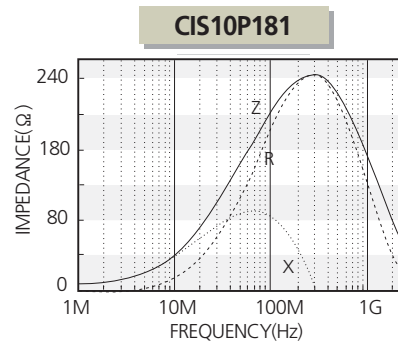
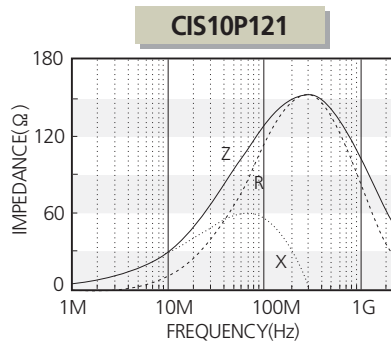
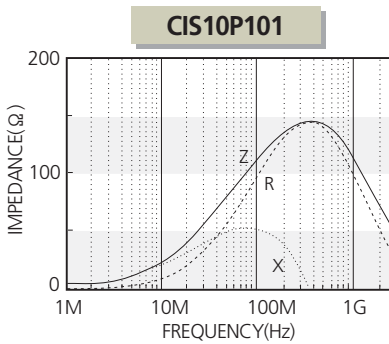
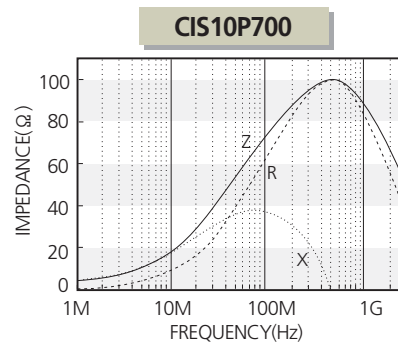
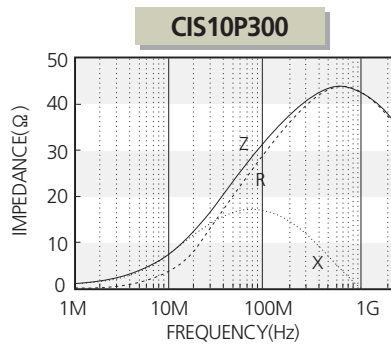
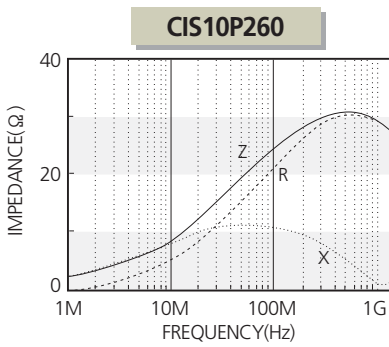

CIS/CIS  
Series

**Electrical Characteristics**

**CIS10P221**

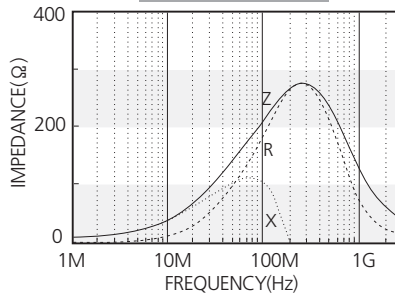

**CIS10P331**

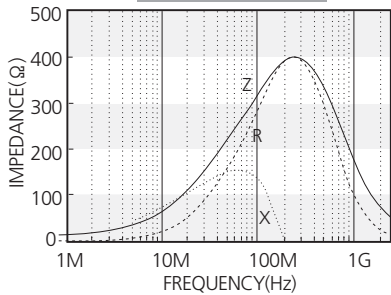

**CIS10P391**

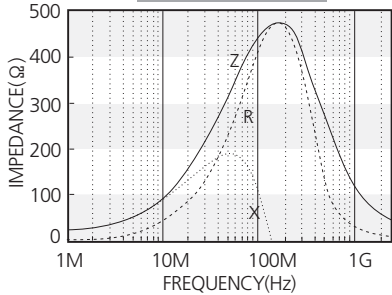

**CIS10P471**

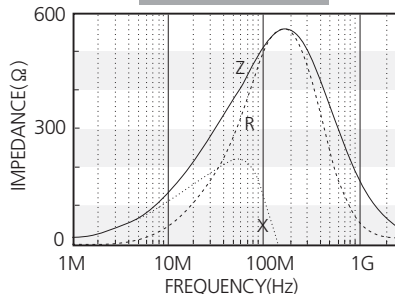

**CIS10P601**

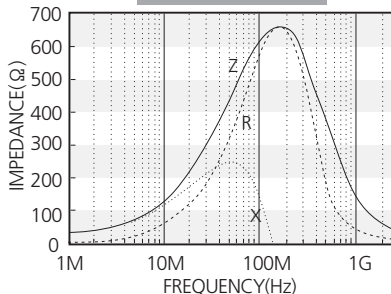

**CIS10J300**

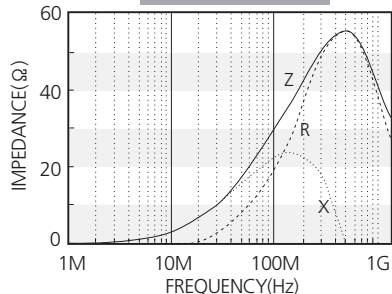

**CIS21P300**

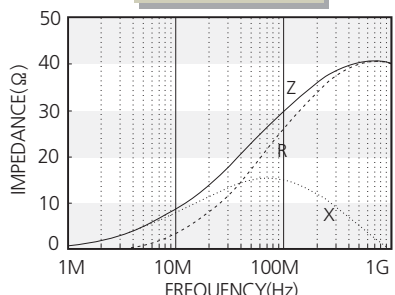

**CIS21P101**

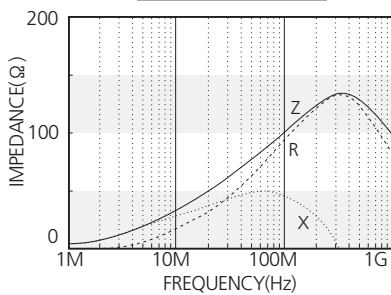

**CIS21J121**

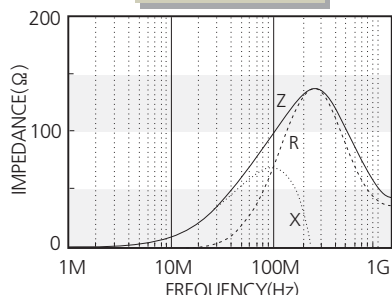

**CIS32P520**

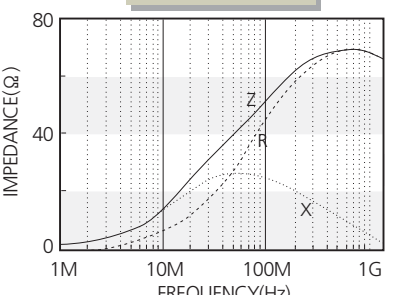

**CIS41P600**

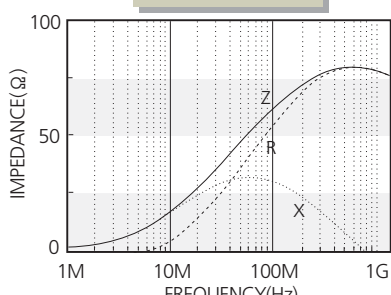

**CIS41J600**

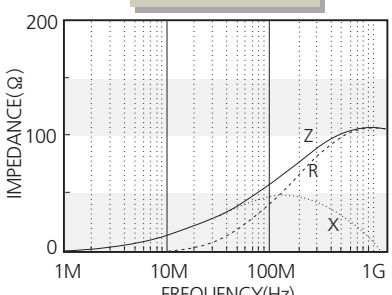

# CIV Series

## GHz noise suppression

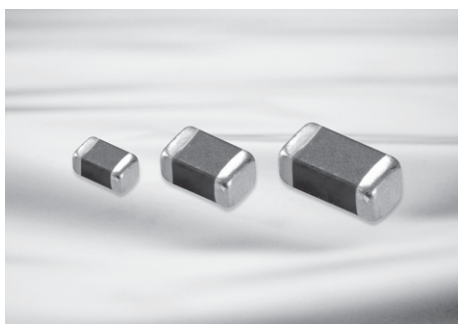

### Feature

- CIV Series have high impedance in a GHz band and suppress GHz noise
- Small beads suitable for surface mounting
- Excellent solderability and high heat resistance for either flow or reflow soldering

### Application

- High frequency EMI prevention application to computers, printers, VCRs, TVs and mobile phones.

Operating Temp	-55~+125°C
Storage Temp (After mounting)	-55~+125°C

### Dimensions

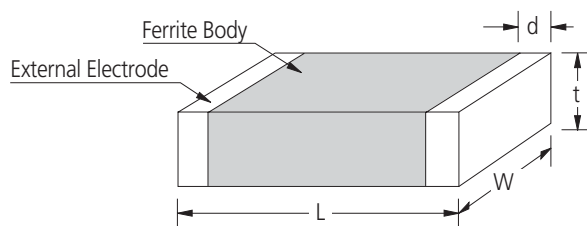

Unit : mm

SIZE CODE	L	W	t	d
03	0.6±0.03	0.3±0.03	0.3±0.03	0.15±0.05
05	1.0±0.05	0.5±0.05	0.5±0.05	0.25±0.1

### Part Numbering

**CI**   **V**   **05**   **U**   **102**   **N**   **C**  
 (1)   (2)   (3)   (4)   (5)   (6)   (7)

- (1) Chip Beads
- (2) V: For GHz Noise Suppression
- (3) Dimension
- (4) Material Code (U,J)
- (5) Nominal impedance (601:600Ω 102:1000Ω ,)
- (6) Thickness option (N: Standard, A: Thinner than standard, B: Thicker than standard)
- (7) Packaging (C: paper tape, E: embossed tape)

### CIV 0603(0201) Type

Part No.	Thickness (mm)	Impedance ( $\Omega$ ) $\pm 25\%$ @100 MHz	Impedance ( $\Omega$ ) $\pm 40\%$ @1 GHz	DC Resistance ( $\Omega$ ) Max.	Rated Current (mA) Max.
CIV03W601N □	0.03 $\pm$ 0.03	600	1500	1.7	150
CIV03W102N □	0.03 $\pm$ 0.03	1000	2300	2.9	120

\* Test equipment: Agilent E4991A + 16197A or Equivalent

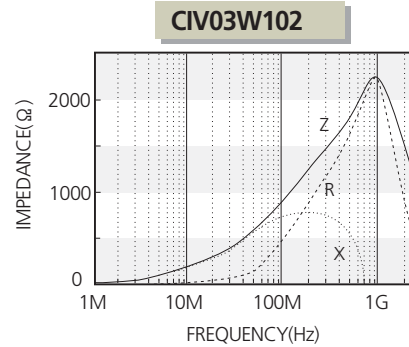
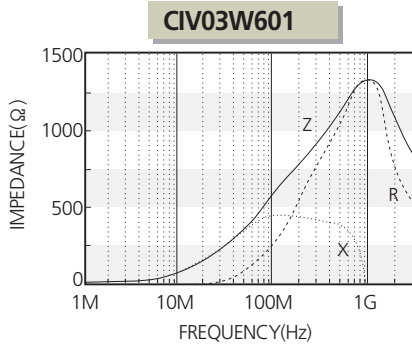

### CIV 1005(0402) Type

Part No.	Thickness (mm)	Impedance ( $\Omega$ ) $\pm 25\%$ @100 MHz	Impedance ( $\Omega$ ) $\pm 40\%$ @1 GHz	DC Resistance ( $\Omega$ ) Max.	Rated Current (mA) Max.
CIV05U601N □	0.5 $\pm$ 0.05	600	1000	0.7	300
CIV05U102N □	0.5 $\pm$ 0.05	1000	1400	1.1	250
CIV05J102N □	0.5 $\pm$ 0.05	1000	2000	1.25	250
CIV05J182N □	0.5 $\pm$ 0.05	1800	2700	2.20	200
CIV05L750N □	0.5 $\pm$ 0.05	75	1000	1.3	200

\* Test equipment: Agilent E4991A + 16192A or Equivalent

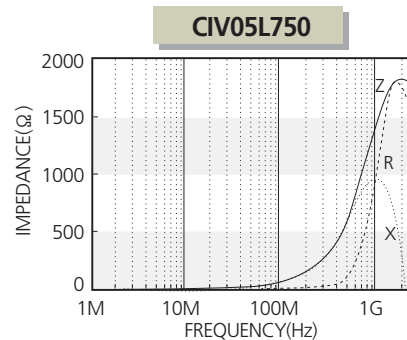
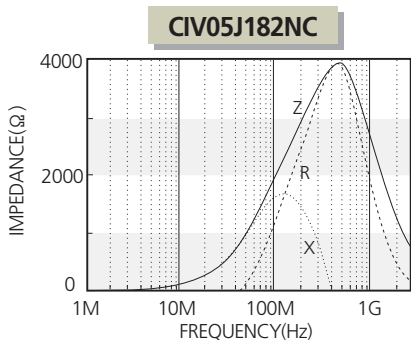
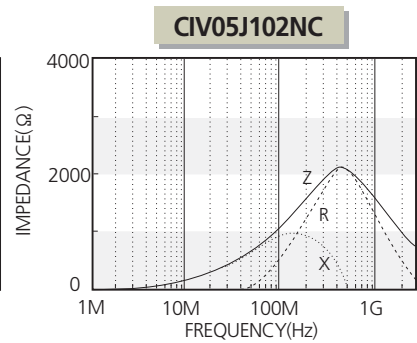
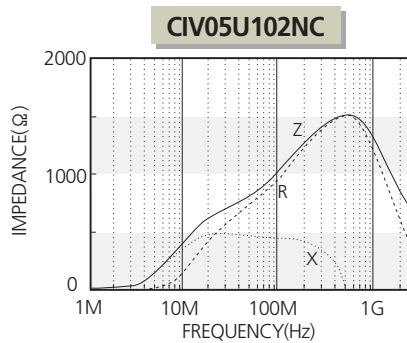
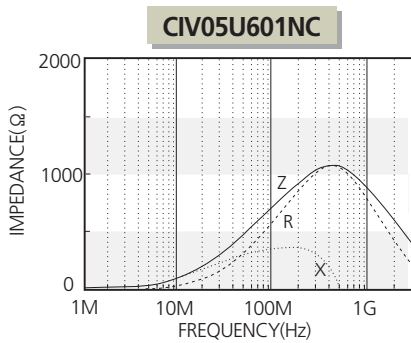

# Common Mode Filter

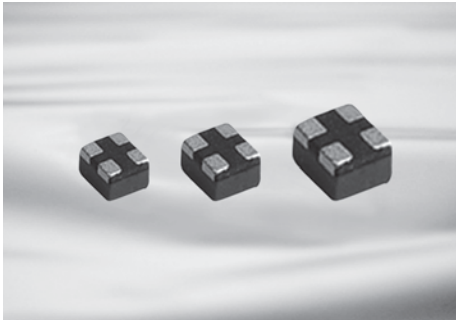

## Features

- A compact film type common mode filter
- Low DC resistance
- Free of all RoHS-regulated substances

## Application

- High speed interface such as LVDS, IEEE1394, USB 2.0, MIPI, S-ata2, etc.

## Dimensions

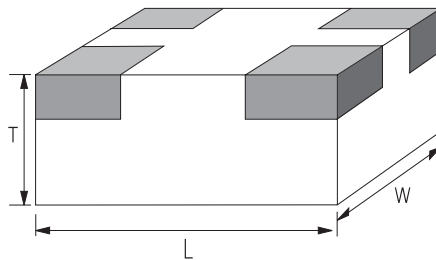

Unit : mm

SIZE CODE	L	W	T
040302	0.45±0.02	0.30±0.02	0.23±0.02
060503	0.65±0.05	0.50±0.05	0.30±0.05
080604	0.85±0.05	0.65±0.05	0.45±0.05

Common Mode Filter

## Part Numbering

**CMF**    **T**    **060503**    **GN**    **900**    **M**    **N**    **C**  
 (1)    (2)    (3)    (4)    (5)    (6)    (7)    (8)

- (1) Common mode filter
- (2) T: Film type
- (3) Dimensions
- (4) Type code (GN: High speed, HN: Ultra High speed, GE: High Speed + ESD)
- (5) Nominal impedance (350: 35Ω, 650: 65Ω, 900: 90Ω )
- (6) Tolerance (N: ± 30%, M: ± 20%, S: Special)
- (7) Internal code
- (8) Packaging (C: Paper tape, E: Embossed tape)



### CMFT080604GN Series

Part No.	Common Mode Impedance( $\Omega$ ) @100MHz	DC Resistance( $\Omega$ ) [1line]	Rated Current (mA) Max.	Rated Voltage (V) Max	Insulation Resistance (M $\Omega$ ) Min.
CMFT080604GN350N	35 $\Omega$ $\pm$ 30%	1.4 max	100	10	10
CMFT080604GN900M	90 $\Omega$ $\pm$ 20%	3.5 max	100	10	10

Impedance vs. Frequency Characteristics(Typ.)

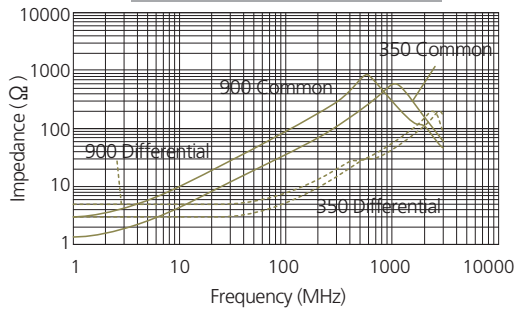

CM/DM Transmission Characteristics(Typ.)

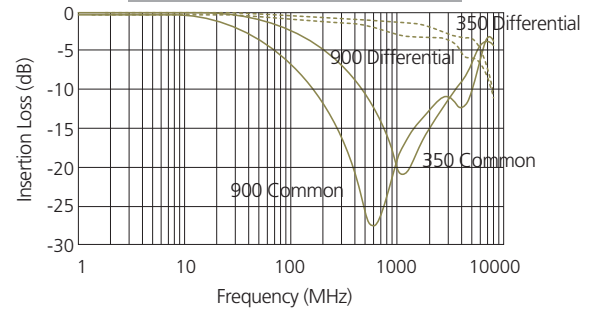

### CMFT060503GN Series

Part No.	Common Mode Impedance( $\Omega$ ) @100MHz	DC Resistance( $\Omega$ ) [1line]	Rated Current (mA) Max.	Rated Voltage (V) Max	Insulation Resistance (M $\Omega$ ) Min.
CMFT060503GN900M	90 $\Omega$ $\pm$ 20%	3.9 max	100	5	10

Impedance vs. Frequency Characteristics(Typ.)

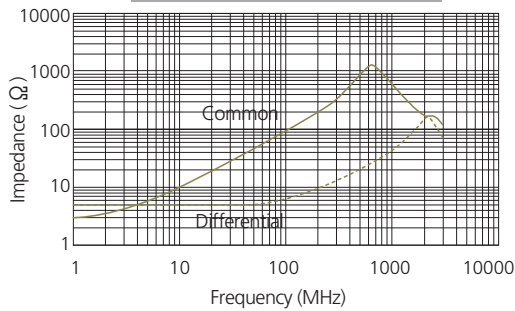

CM/DM Transmission Characteristics(Typ.)

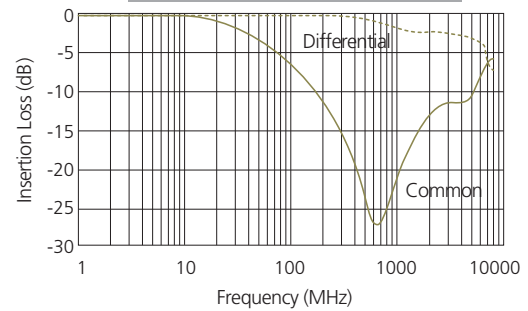



### CMFT080604HN Series

Part No.	Common Mode Impedance( $\Omega$ ) @100MHz	DC Resistance( $\Omega$ ) [1line]	Rated Current (mA) Max.	Rated Voltage (V) Max	Insulation Resistance (M $\Omega$ ) Min.
CMFT080604HN350S	35 $\Omega$ $\pm$ 12 $\Omega$	1.3 max	100	10	10

Impedance vs. Frequency Characteristics(Typ.)

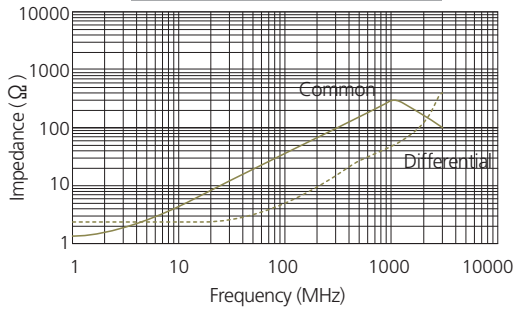

CM/DM Transmission Characteristics(Typ.)

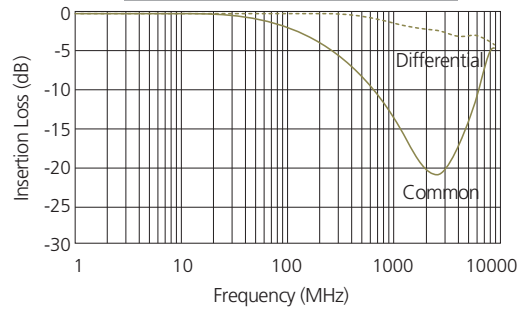

### CMFT060503HN Series

Part No.	Common Mode Impedance( $\Omega$ ) @100MHz	DC Resistance( $\Omega$ ) [1line]	Rated Current (mA) Max.	Rated Voltage (V) Max	Insulation Resistance (M $\Omega$ ) Min.
CMFT060503HN350S	35 $\Omega$ $\pm$ 12 $\Omega$	2.4 max	100	5	10

Impedance vs. Frequency Characteristics(Typ.)

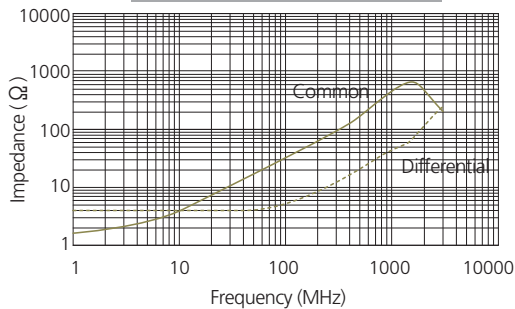

CM/DM Transmission Characteristics(Typ.)

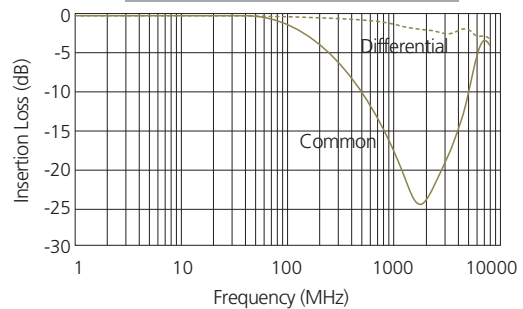

Common Mode Filter

### CMFT040302HN Series

Part No.	Common Mode Impedance( $\Omega$ ) @100MHz	DC Resistance( $\Omega$ ) [1line]	Rated Current (mA) Max.	Rated Voltage (V) Max	Insulation Resistance (M $\Omega$ ) Min.
CMFT040302HN350S	35 $\Omega$ $\pm$ 12 $\Omega$	3.5 max	100	5	10

Impedance vs. Frequency Characteristics(Typ.)

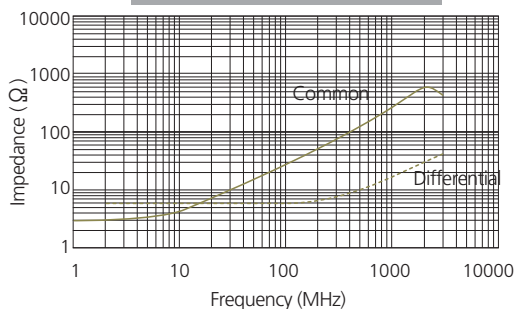

CM/DM Transmission Characteristics(Typ.)

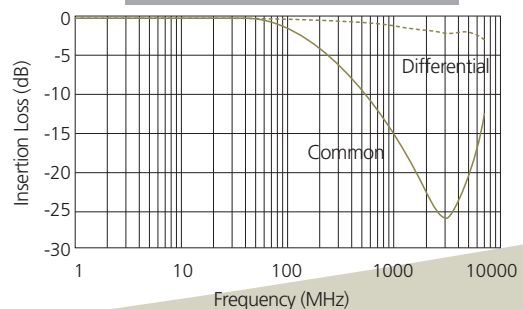



### CMFT080604GE Series

Part No.	Common Mode Impedance( $\Omega$ ) @100MHz	DC Resistance( $\Omega$ ) Max[1line]	Capacitance (pF) Max @1MHz	Leakage Current ( $\mu$ A) Max.	Rated Current (mA) Max.	Rated Voltage (V) Max	Insulation Resistance ( $M\Omega$ ) Min.
CMFT080604GE750N	$75\Omega \pm 30\%$	3.3 max	1	10	100	10	10

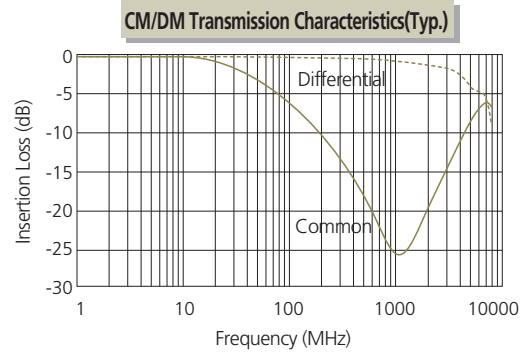
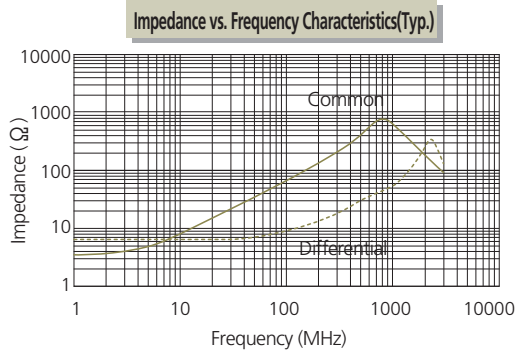

# EMI products

## 3-Terminal Capacitor

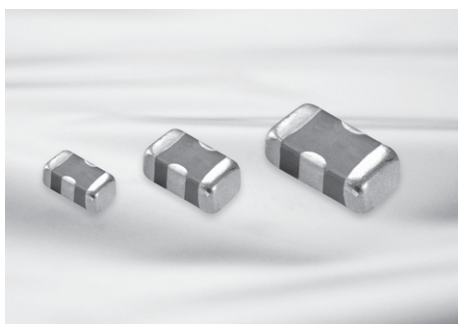

### Feature

- Lower ESL Characteristics
- High Performance at High Frequency Range
- Small size enables high density mounting
- Effective noise suppression filter

### Application

- High frequency EMI prevention applicable to digital equipment such as TV, VCR, LCD monitors and PDP TVs.
- Computer equipment such as personal computers and peripherals.

More excellent by-pass filter than MLCC.  
EMIC Series is capacitor type of three terminals and low residual inductance value.

### Dimensions

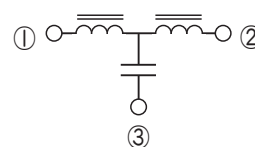
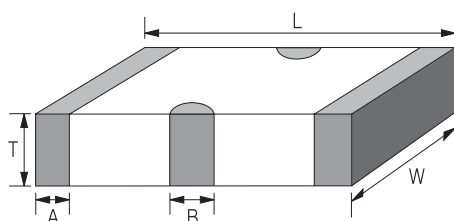

Equivalent circuit

Unit : mm

SIZE CODE	L	W	T	A	B
10	1.6±0.15	0.8±0.1	0.6±0.1	0.25±0.15	0.4±0.1
21	2.0±0.2	1.25±0.2	0.8±0.2	0.3±0.2	0.6±0.2
31	3.2±0.2	1.6±0.2	1.1max	0.4±0.3	1.0±0.3

### Part Numbering

**EMIC 10 B 473 S A N C**  
(1) (2) (3) (4) (5) (6) (7) (8)

- (1) Chip EMI Filter 3-Terminal Capacitor For Signal line
- (2) Dimensions
- (3) Capacitance temperature characteristics  
C : 0±30ppm/°C  
A : ±15%(-55~85°C)  
B : ±15%(-55~125°C)  
F : -82~+22%(-30~+85°C)
- (4) Nominal capacitance (101: 100pF, 102: 1000pF, 104: 100000pF)
- (5) Capacitance tolerance (M: ±20%, S: +50%,-20%)
- (6) Rated voltage (P: 10V, O: 16V, A: 25V, B: 50V)
- (7) Thickness option (N: Standard, A: Thinner than standard, B: Thicker than standard)
- (8) Packaging (C: Paper 7" Reel, D: Paper 13" Reel)



### EMIC 1608(0603) Type

Part No.	Capacitance (pF)	Tolerance	Rated Voltage (V) Max.	Insulation Resistance (MΩ)	DC Resistance (Ω) Max.	Rated Current (mA) Max
EMIC10B104MONC	100000	+20~-20%	16	1000 min	0.1	2000

### EMIC 2012(0805) Type

Part No.	Capacitance (pF)	Tolerance	Rated Voltage (V) Max.	Insulation Resistance (MΩ)	DC Resistance (Ω) Max.	Rated Current (mA) Max
EMIC21B471SBNC	470	+50~-20%	50	10000 min	0.3	300
EMIC21B223SBNC	22000	+50~-20%	50	10000 min	0.08	1000
EMIC21F104SANC	100000	+50~-20%	25	1000 min	0.1	1000

### EMIC 3216(1206) Type

Part No.	Capacitance (pF)	Tolerance	Rated Voltage (V) Max.	Insulation Resistance (MΩ)	DC Resistance (Ω) Max.	Rated Current (mA) Max
EMIC31B222MANC	2200	+20~-20%	25	1000 min	0.3	300
EMIC31B104SANC	100000	+50~-20%	25	1000 min	0.1	1000

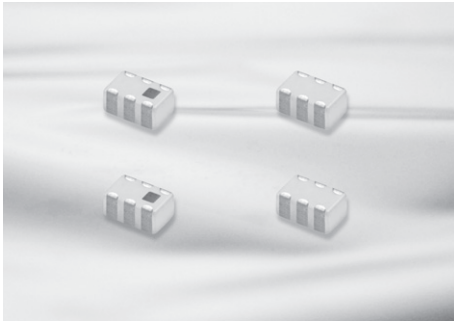

## Feature

- Small and thin size
- Low Insertion Loss
- Lead free

## Application

- Applying to mobile phones and wireless LAN Combo.
- AMPS/GPS, AMPS/PCS, CDMAWCDMA, CDMA/S-DMB, PCS/S-DMB, T-DMB/CDMA,
- T-DMB/K-PCS, CDMAW-LAN, CDMA/K-PCS, iDEN/GPS

Diplexer is used for separating specific frequency in mobile phones and wireless LAN 11a/b/g. Two kinds of pin assignment demanded on customers are lined up so that designing circuit regardless output direction is available.

## Dimensions

### ■ F Type

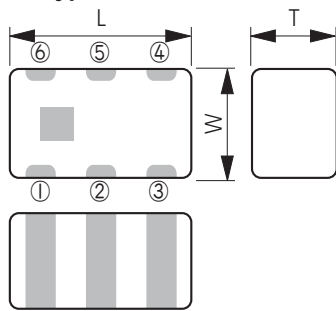

### ■ H Type

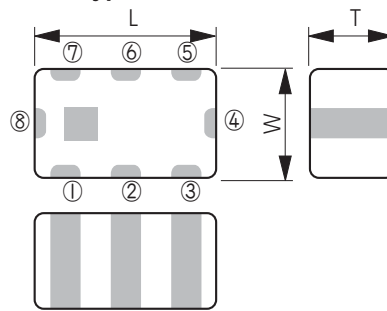

Dimension(mm)		Terminal	
L	2.00±0.15	Common	②
W	1.25±0.15	Low Band	⑥
		High Band	④
T	0.95±0.10	GND	① ③ ⑤

Dimension(mm)		Terminal	
L	2.00±0.15	Common	②
W	1.25±0.15	Low Band	⑧
		High Band	④
T	0.95±0.15	GND	①③⑤⑥⑦

※ Pin assignment can be changeable

## Part Numbering

**DX 21 T F 3L 01**  
 (1) (2) (3) (4) (5) (6)

- (1) Diplexer
- (2) Dimension
- (3) Material code
- (4) Terminal number (F: 6, H: 8)
- (5) Low band: Band 3  
High band: L Band
- (6) Serial number, pin assignment



## HHP Diplexer

Part No.	Application	Thickness (mm)	Center Frequency	Insertion Loss (dB) Max.	Attenuation(dB) Min.
DX21TFAG01	APMS / GPS	0.95	859MHz/ 1575MHz	0.5 at 859MHz	15 at 1575MHz
				0.7 at 1575MHz	15 at 859MHz
DX21TFAG02	APMS / GPS	0.95	859MHz/ 1575MHz	0.5 at 859MHz	15 at 1575MHz
				0.7 at 1575MHz	15 at 859MHz
DX21TFAP02	APMS / PCS	0.95	859MHz/ 1920MHz	0.5 at 859MHz	20 at 1920MHz
				0.55 at 1920MHz	20 at 859MHz
DX21TFAP03	APMS / PCS	0.95	859MHz/ 1920MHz	0.5 at 859MHz	20 at 1920MHz
				0.55 at 1920MHz	20 at 859MHz
DX21DFIG01	iden / GPS	1.05	806MHz/ 1576.42MHz	0.65 at 873.5MHz	16 at 1575.42MHz
					16 at 1631MHz
				0.70 at 1575.42MHz	13 at 1798MHz
					17 at 873.5MHz
DX21TFCD01	CDMA / S-DMB	0.95	859MHz/ 2630MHz	0.5 at 859MHz	20 at 2645MHz
				0.6 at 2645MHz	20 at 859MHz
DX21TFCD02	CDMA / S-DMB	0.95	859MHz/ 2630MHz	0.5 at 859MHz	17 at 2630MHz
				0.6 at 2630MHz	20 at 859MHz
DX21TFCL01	CDMA / W-LAN	0.95	859MHz/ 2450MHz	0.5 at 859MHz	20 at 2450MHz
				0.6 at 2450MHz	20 at 859MHz
DX21TFKL01	K-PCS / W-LAN	0.95	1810MHz/ 2450MHz	0.8 at 1810MHz	15 at 2450MHz
				1.0 at 2450MHz	15 at 1810MHz
DX21TFM01	Cellular/WiMAX	1.00	1368MHz/ 2592.5MHz	1.0 at 1368MHz	15 at 2592.5MHz
				1.2 at 2592.5MHz	15 at 1368MHz

**Electrical Characteristics**

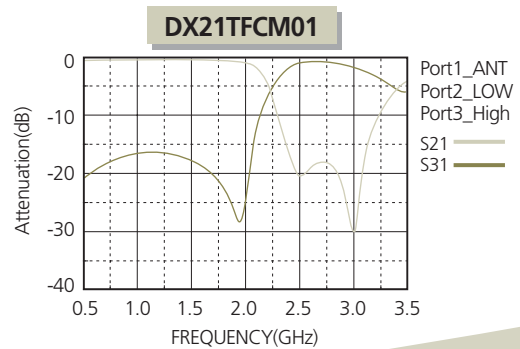
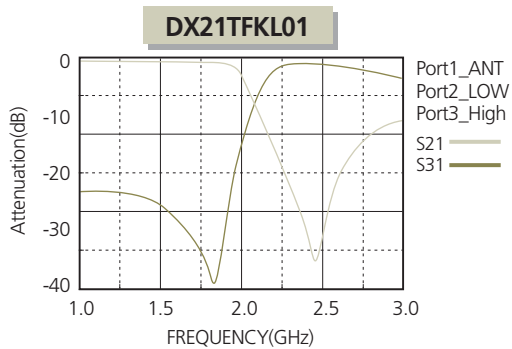
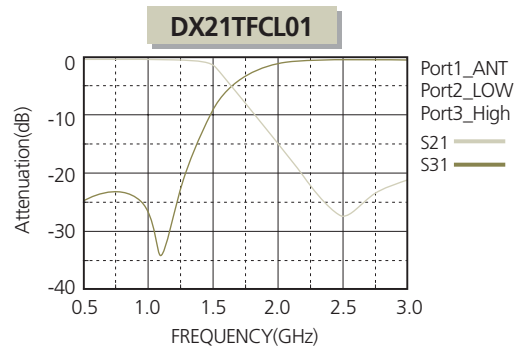
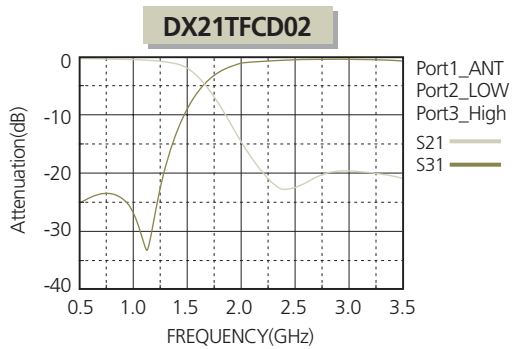
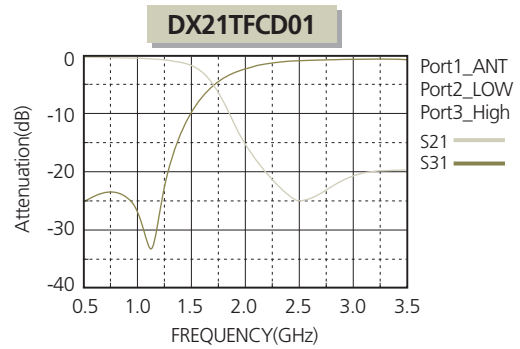
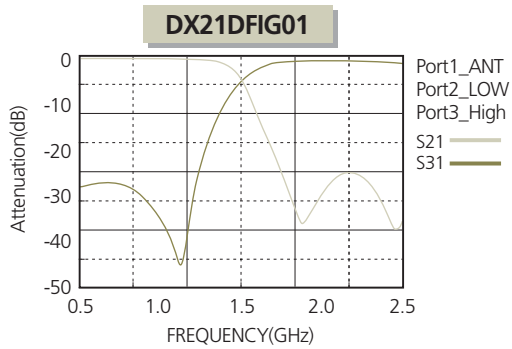
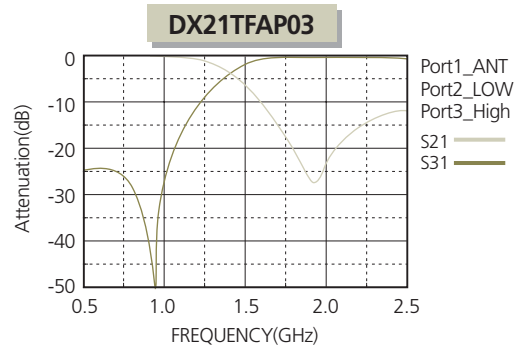
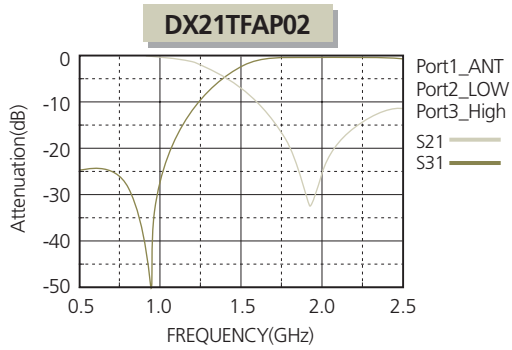
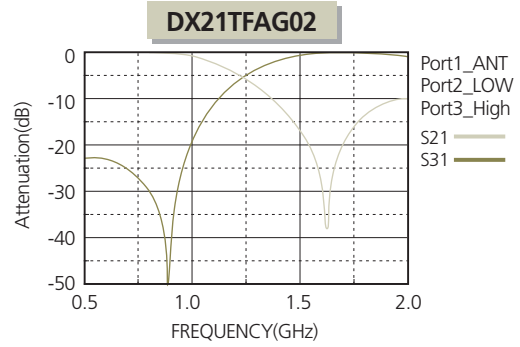
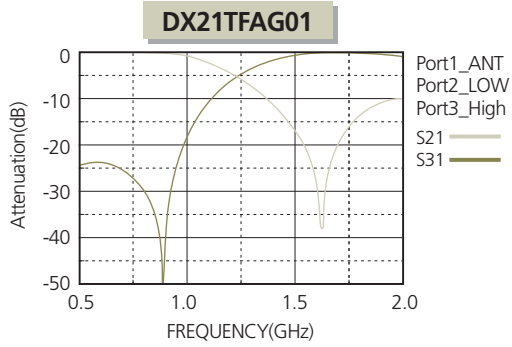

Diplexer

# LC Filter

Band pass/Low pass filter

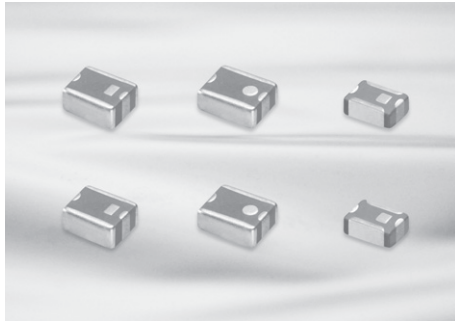

## Feature

- High Attenuation, Low Insertion Loss
- Small and Thin size
- Lead free

## Application

- Bluetooth Module
- W-LAN Module
- HHP-WiBro, WiMAX, DMB

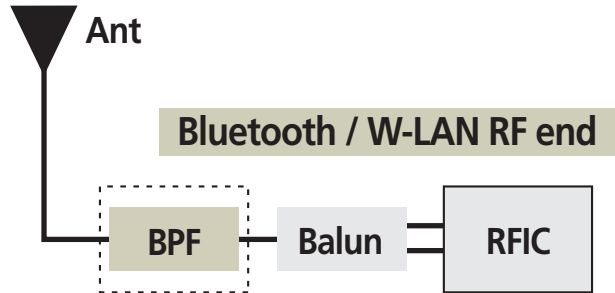

Chip LC filter made by our own RF design and LTCC fabrication technology has excellent products with low loss and good attenuation characteristics

## Part Numbering

<b>LC</b>	<b>B</b>	<b>10</b>	<b>C</b>	<b>2450</b>	<b>K1</b>
(1)	(2)	(3)	(4)	(5)	(6)

- (1) Chip LC Filter
- (2) B: Band Pass Filter, L : Low Pass Filter
- (3) Dimension (10 : 1.6x0.8mm, 21 : 2.0x1.25mm, 22 : 2.5x2.0mm)
- (4) Material code (C, M, T)
- (5) Center frequency [MHz]
- (6) Serial Number



### Band Pass Filter

Application	Part No.	L×W×T (mm)	Pass Band (GHz)	IL (dB) Max.	VSWR	Attenuation (dB) Min. (at MHz)			
11b/g BT	LCB22M2450B1	2.5×2.0×1.0	2.4 ~2.5	1.2	2.0	50 (1200)	30 (2f0)		
	LCB22B2450L1	2.5×2.0×1.0	2.4 ~2.5	2.2	2.0	40 (2100)	30 (2f0)		
	LCB22B2450S1	2.5×2.0×1.0	2.4 ~2.5	2.5	2.0	20 (1700~1900)	20 (2700)	30 (2f0)	15 (3f0)
	LCB21B2450F2	2.0×1.25×0.75	2.4 ~2.5	2.6	2.0	40 (880~960)	30 (1710~1990)	30 (2f0)	
	LCB21B2450Q1	2.0×1.25×0.95	2.4 ~2.5	1.8	2.0	30 (1300)	10 (2000)	20 (3600)	35 (2f0)
	LCB21B2450Q3	2.0×1.25×0.75	2.4 ~2.5	1.8	2.0	30 (1300)	10 (2000)	15 (3600)	30 (2f0)
	LCB10B2450K3	1.6×0.8×0.6	2.4 ~2.5	2.2	2.0	25 (880~960)	16 (2f0)	20 (3f0)	
	LCB10B2450K4	1.6×0.8×0.6	2.4 ~2.5	1.8	2.0	27 (880~960)	36 (2f0)	36 (3f0)	
T-DMB	LCB22G0205A3	2.5×2.0×1.2	0.174 ~0.237	1.5	2.0	10 (100)	40 (1750~1870)		
	LCB22G0205B3	2.5×2.0×1.2	0.174 ~0.237	1.5	2.0	10 (100)	40 (824~894)		

### Low Pass Filter

Part No.	Application	L×W×T (mm)	Pass Band (GHz)	IL (dB) Max.	VSWR	Attenuation (dB) Min. (at MHz)		
LCL10T2500A1	WiBro WiMAX	1.6×0.8×0.6	2.3 ~2.7	0.55	1.7	35 (2f0)	25 (3f0)	
LCL10T2450A1	11b/g,BT	1.6×0.8×0.6	2.4 ~2.5	0.45	1.5	35 (2f0)	25 (2f0)	



**Dimensions & Frequency Characteristics Band Pass Filter**

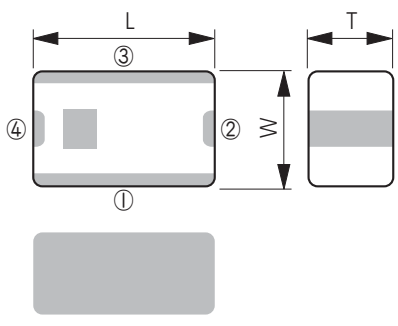

Dimension(mm)	
L	$2.50 \pm 0.20$
W	$2.00 \pm 0.20$
T	$1.00 \pm 0.10$

Terminal	
Input	④
Output	②
GND	① ③

S11  
S21

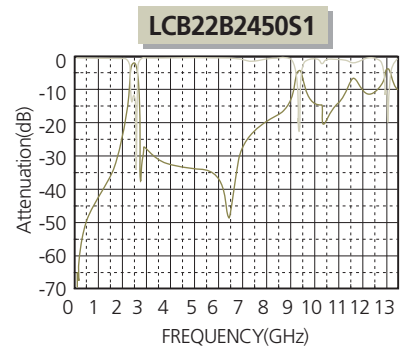
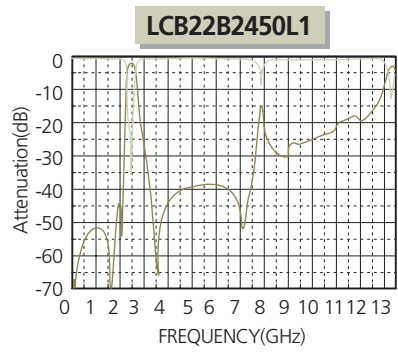
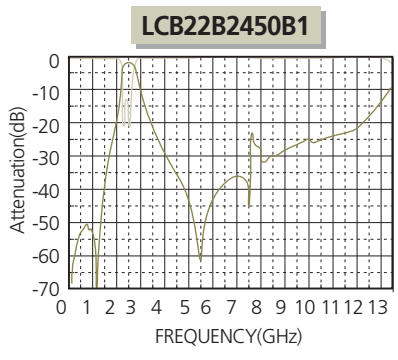

**Dimensions & Frequency Characteristics Band Pass Filter**

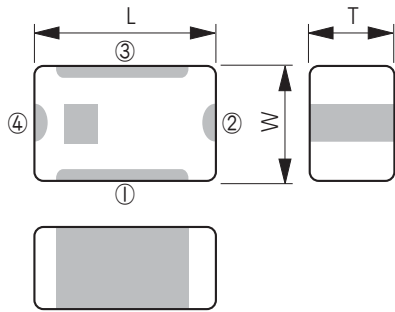

Dimension(mm)	
1608	L 1.60+0.2/-0.1
	W 0.80+0.2/-0.1
	T 0.60±0.10
2012	L 2.00±0.15
	W 1.25±0.10
	T 0.95±0.10 (0.75max : Q3, Q5)

Terminal	
Input	④
Output	②
GND	① ③

S11  
S21

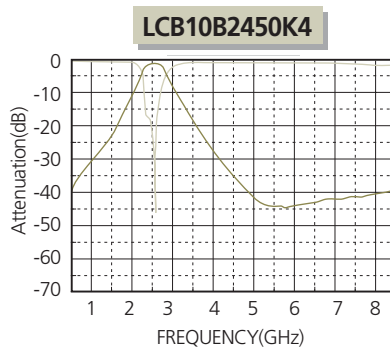
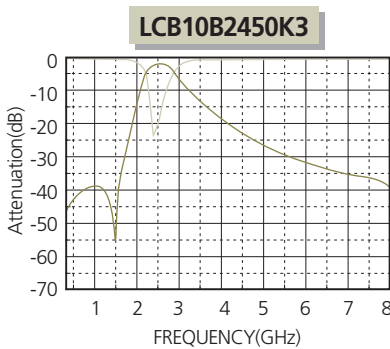
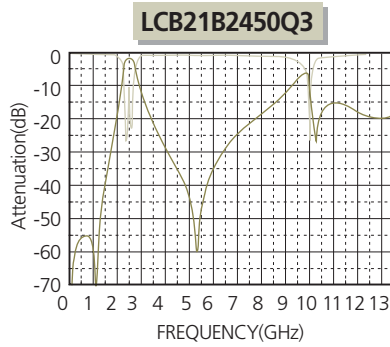
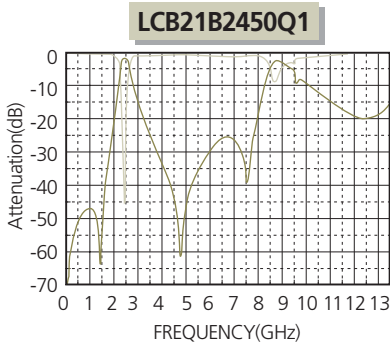

## Dimensions & Frequency Characteristics Band Pass Filter

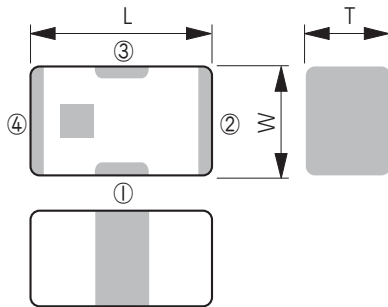

Dimension(mm)		Terminal	
2012	L	$2.00 \pm 0.15$	Input ①
	W	$1.25 \pm 0.10$	Output ③
	T	0.75max	GND ② ④

S11  
S21

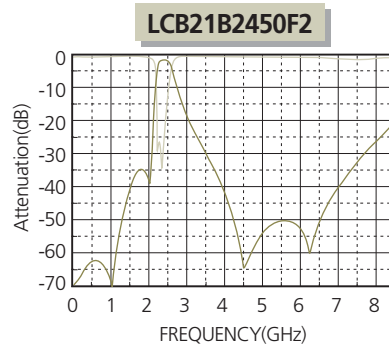

**Dimensions & Frequency Characteristics Band Pass Filter**

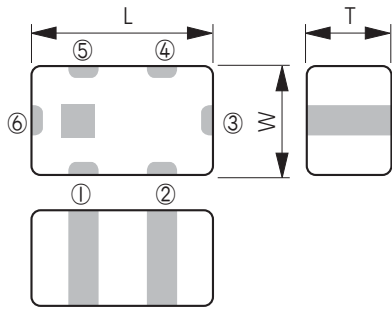

Dimension(mm)	
L	2.50±0.20
W	2.00±0.20
T	1.20±0.10

	Terminal	
	A3	B3
Input	⑥	⑥
Output	③	③
GND	① ⑤	① ④
N.C	② ④	② ⑤

S11  
S21

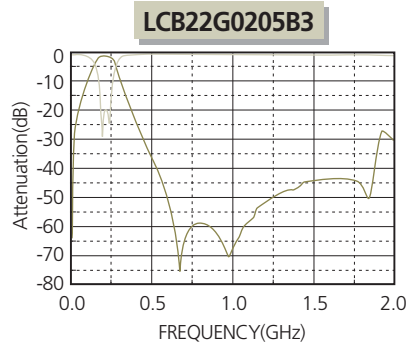
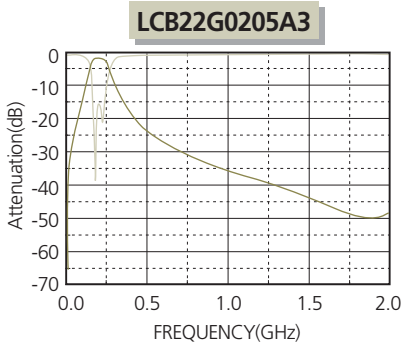

**Dimensions & Frequency Characteristics Low Pass Filter**

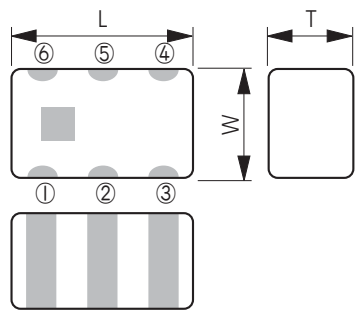

Dimension(mm)	
L	$1.60 \pm 0.10$
W	$0.80 \pm 0.10$
T	$0.60 \pm 0.10$

Terminal	
Input	②
Output	⑤
GND	① ③ ④ ⑥

S11 —  
S21 —

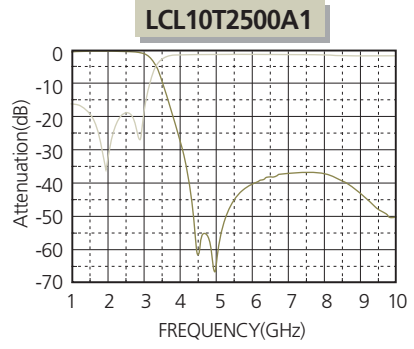
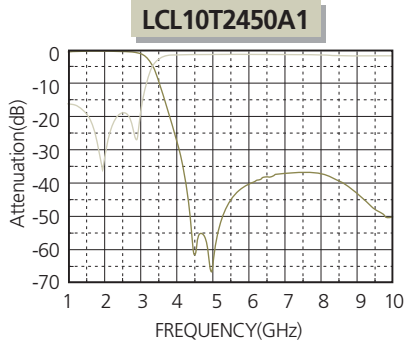

## Soldering Condition

### REFLOW SOLDERING

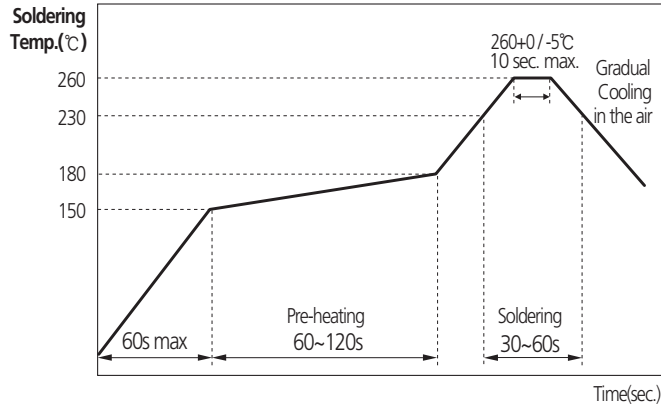

Soldering Temp. (°C)	Pre-heating Time (sec)	Soldering Time (sec)
260+0/-5°C	60~120	30~60

### FLOW SOLDERING

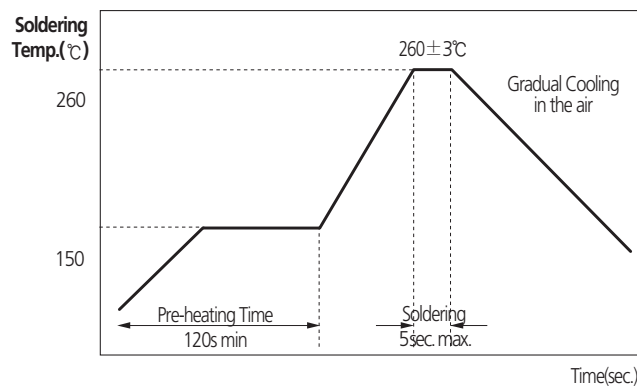

$\Delta T$ (°C)	Soldering Temp. (°C)	Pre-heating Time(sec)	Soldering Time(sec)
$\leq 150$ (1206 and below size)	260±3	$\geq 120$	$\leq 5$

### SOLDER IRON(Hand Soldering)

Variation of Temp.(°C)	Soldering Temp(°C)	Pre-heating Time(sec.)	Soldering Time(sec.)	Cooling Time(sec.)	Condition of Iron Facilities		
					Wattage	Tip Diameter	Soldering Time
$\Delta T \leq 130$	300±10°C max.	$\geq 60$ sec.	$\leq 4$ sec.	-	20W max.	3mm max.	4 sec max.

\* Caution - Iron tip should not contact with ceramic body directly

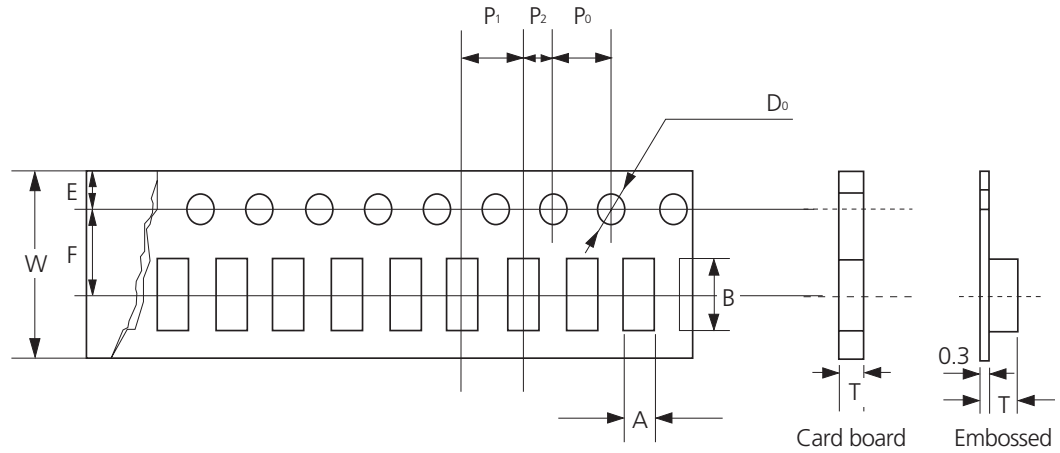
**Packaging**

Unit: mm

Type	02	03	05	10	21				22				31			32	41		
Tape	Card	Card	Card	Card	Card	Embossed				Card				Embossed			Card	Embossed	Embossed
Chip Thickness	0.2	0.3	0.5	0.5	0.8	0.9	1.0	1.25	0.5	0.85	1.0	1.2	0.6	0.8	1.1	0.85	1.3	N1.6 A1.2	
Chip Cavity	A	0.25 ±0.02	0.40 ±0.06	0.65 ±0.1	1.0 ±0.05	1.0 ±0.2	1.5 ±0.2	1.5 ±0.2	1.5 ±0.2	1.55 ±0.05	1.45 ±0.1	2.29 ±0.1	2.23 ±0.1	1.9 ±0.2	1.9 ±0.2	1.9 ±0.2	2.0 ±0.2	2.9 ±0.2	1.6T:1.9±0.2 1.2T:1.7±0.2
	B	0.46 ±0.02	0.70 ±0.06	1.15 ±0.1	1.9 ±0.05	1.8 ±0.2	2.3 ±0.2	2.3 ±0.2	2.3 ±0.2	2.3 ±0.55	2.4 ±0.2	2.74 ±0.1	2.73 ±0.1	3.6 ±0.2	3.6 ±0.2	3.6 ±0.2	3.6 ±0.2	3.6 ±0.2	3.6 ±0.2
T max	0.31 ±0.03	0.45	0.8	0.65 ±0.05	1.1	1.1	2.0	2.0	0.6 ±0.05	0.95 ±0.1	1.14 ±0.1	1.6 ±0.1	1.15	1.4	1.4	1.1	1.55	1.6T:1.95 1.2T:1.45	
W	8.0 ±0.1	8.0 ±0.2	8.0 ±0.2	8.0 ±0.1	8.0 ±0.2	8.0 ±0.2	8.0 ±0.2	8.0 ±0.2	8.0 ±0.1	8.0 ±0.3	8.0 ±0.2	8.0 ±0.2	8.0 ±0.2	8.0 ±0.2	8.0 ±0.2	8.0 ±0.2	8.0 ±0.2	1.6T:12-0.1±0.3 1.2T:12±0.1	
F	3.5 ±0.05	3.5 ±0.05	3.5 ±0.05	3.5 ±0.05	3.5 ±0.05	3.5 ±0.05	3.5 ±0.05	3.5 ±0.05	3.5 ±0.05	3.5 ±0.05	3.5 ±0.05	3.5 ±0.05	3.5 ±0.05	3.5 ±0.05	3.5 ±0.05	3.5 ±0.05	3.5 ±0.05	5.5 ±0.05	
E	1.75 ±0.05	1.75 ±0.1	1.75 ±0.1	1.75 ±0.05	1.75 ±0.1	1.75 ±0.1	1.75 ±0.1	1.75 ±0.1	1.75 ±0.1	1.75 ±0.1	1.75 ±0.1	1.75 ±0.1	1.75 ±0.1	1.75 ±0.1	1.75 ±0.1	1.75 ±0.1	1.75 ±0.1	1.75 ±0.1	
P <sub>1</sub>	2.0 ±0.05	2.0 ±0.05	2.0 ±0.05	4.0 ±0.1	4.0 ±0.1	4.0 ±0.1	4.0 ±0.1	4.0 ±0.1	4.0 ±0.1	4.0 ±0.1	4.0 ±0.1	4.0 ±0.1	4.0 ±0.1	4.0 ±0.1	4.0 ±0.1	4.0 ±0.1	4.0 ±0.1	4.0 ±0.1	4.0 ±0.1
P <sub>2</sub>	2.0 ±0.05	2.0 ±0.1	2.0 ±0.1	2.0 ±0.1	2.0 ±0.1	2.0 ±0.05	2.0 ±0.1	2.0 ±0.1	2.0 ±0.05	2.0 ±0.1	2.0 ±0.1	2.0 ±0.1	2.0 ±0.1	2.0 ±0.1	2.0 ±0.05	2.0 ±0.1	2.0 ±0.1	2.0 ±0.1	2.0 ±0.05
P <sub>0</sub>	4.0 ±0.05	4.0 ±0.1	4.0 ±0.1	4.0 ±0.1	4.0 ±0.1	4.0 ±0.1	4.0 ±0.1	4.0 ±0.1	4.0 ±0.1	4.0 ±0.1	4.0 ±0.1	4.0 ±0.1	4.0 ±0.1	4.0 ±0.1	4.0 ±0.1	4.0 ±0.1	4.0 ±0.1	4.0 ±0.1	4.0 ±0.1
D <sub>0</sub>	∅1.5 ±0.1	∅1.5 ±0.1	∅1.5 ±0.1	∅1.55 ±0.03	∅1.5 ±0.1	∅1.5 ±0.1	∅1.5 ±0.1	∅1.5 ±0.1	∅1.55 ±0.1	∅1.5 ±0.1	∅1.55 ±0.1	∅1.55 ±0.1	∅1.5 ±0.1	∅1.5 ±0.1	∅1.5 ±0.1	∅1.5 ±0.1	∅1.5 ±0.1	∅1.5 ±0.1	∅1.5 ±0.1
Quantity / Reel (PCS)	20,000	10,000	10,000	4,000	4,000	4,000	3,000	2,000	4,000	4,000	3,000	2,500	4,000	3,000	3,000	4,000	2,500	2,000 /3,000	

• Reel dimensions

Unit: mm

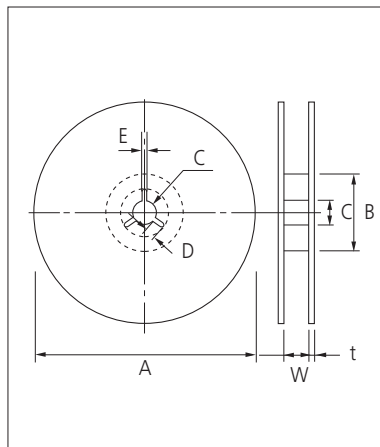

Symbol	Tape Width	A	B	C	D
7" Reel	8mm	180±0/-3	∅60±1/0	∅13±0.3	4±0.2
	12mm	∅180±0/-3	∅60±1/0	∅13±0.3	4±0.2
10" Reel	8mm	∅258±0/-3	∅80±1/0	∅13±0.3	4±0.2
	12mm	∅258±0/-3	∅80±1/0	∅13±0.3	4±0.2
13" Reel	8mm	∅330±2.0	∅80±1.0	∅13±0.3	4±0.2
	12mm	∅330±2.0	∅80±1.0	∅13±0.3	4±0.2

Symbol	Tape Width	E	W	t
7" Reel	8mm	2.0±0.5	9±0.5	1.2±0.2
	12mm	2.0±0.5	13±0.5	1.2±0.2
10" Reel	8mm	2.0±0.5	9±0.5	1.8±0.2
	12mm	2.0±0.5	13±0.5	1.8±0.2
13" Reel	8mm	2.0±0.5	9±0.5	2.2±0.2
	12mm	2.0±0.5	13±0.5	2.2±0.2



 **Attention**

1. This catalogue is valid only to the products purchased either from us or through our official distributors.
2. Product specifications included in this catalogue are effective as of September 1, 2014.  
Please be advised that they are standard product specifications for reference only.  
We may change, modify or discontinue the product specifications without notice at any time.  
So, you need to approve the product specifications before placing an order. Should you have any question regarding our product specifications, please contact our sales personnel or application engineers.
3. We may modify or cease to produce the products listed in this catalogue without notice. Should you have any question, please contact our sales personnel or application engineers.
4. Without obtaining our permission, you should not be allowed to reproduce, copy, use or transfer any content or information contained this catalogue in any manner whatsoever for any purpose.
5. In no event, will we be responsible for any claim, dispute, damage or liability whatsoever arising from, relating to or in connection with your misuse of the products or/and information included in this catalogue.  
We will also not assume any responsibilities whatsoever for any claim, dispute, damage or liability with regards to the intellectual property rights or other related rights of ours or any third party associated with your use of our products and/or information contained in this catalogue. We expressly disclaim that no license is granted regarding the aforementioned rights.
6. Please note that the products in this catalogue are not designed or intended to use for the applications set forth below. So, if you intend to use the products in this catalogue for the applications listed below, you should contact our sales personnel or application engineers before using.  
Please be aware that any misuse of the products deviating from product specifications or information provided in this catalogue may cause a serious property damage or a personal injury.
  - ① Aerospace/Aviation equipment
  - ② Transportation equipment (vehicles, trains, ships, etc)
  - ③ Medical equipment
  - ④ Military equipment
  - ⑤ Disaster prevention/crime prevention equipment
  - ⑥ Any other applications with the same as or similar complexity or reliability to the applications set forth above.



ISO/TS 16949



ISO 14001



OHSAS 18001



QC080000



**Quality System Certification List**

Table 1: Certification list of Samsung Factory

Certification	Section	Busan (Korea)
TS 16949	Authority	BSI
	Number	BSI TS 91430-001
	Date	2013 - 08 - 08
	Validity	2016 - 08 - 07
ISO 14001	Authority	BSI
	Number	BSI EMS 599427
	Date	2013 - 06 - 25
	Validity	2016 - 06 - 24
OSHAS 18001	Authority	BSI
	Number	BSI OHS 599428
	Date	2013 - 06 - 25
	Validity	2016 - 06 - 24
QC080000	Authority	UL
	Number	UL KR-HSPM-0112
	Date	2013 - 06 - 27
	Validity	2016 - 07 - 19





## Passive components sales offices

### • Head office

150, Meayoungro(Maetan-dong)  
Yeongtong-gu, Suwon-city,  
Gyeonggi province, Korea, 443-743  
Tel : +82-31-210-5114

#### Europe

Tel : +82-31-210-6328  
E-mail : james.pyun@samsung.com

#### America

Tel : +82-31-210-6803  
E-mail : wesley.roh@samsung.com

#### China

Tel : +82-31-210-3476  
E-mail : james.h.leel@samsung.com

#### Japan

Tel : +82-31-210-6304  
E-mail : jdkim1@samsung.com

#### Domestic

Tel : +82-31-210-3692  
E-mail : jeongki.um@samsung.com

### • Manufacturing sites

#### Suwon Plant(Korea)

150, Meayoungro(Maetan-dong)  
Yeongtong-gu, Suwon-city,  
Gyeonggi province, Korea, 443-743  
Tel : +82-31-210-5114

#### Busan Plant (Korea)

333, Noksan Sanupjoongro(Songjeong-dong,)  
Gangseo-gu, Busan, Korea, 618-270  
Tel : +82-51-970-7114

### • Asia sales offices

#### Shenzhen office

46 F, New World Center, Yitian Road, Futian  
District, Shenzhen, China 518026  
Tel : +86-755-8608-5579  
E-mail : andy.li@samsung.com

#### Shanghai office

Rm. 1211, Shanghai International Trade  
Center No.2201 Yan An(W) Rd., Shanghai,  
China 200335  
Tel : +86-21-2231-4341  
E-mail : koogil@samsung.com

#### Beijing office

12/F China Merchants Tower No. 118,  
Jian Guo Lu, Chao Yang District, Beijing, China  
Tel : +86-10-6566-8100-6606  
E-mail : kiko.wang@samsung.com

#### Qingdao Office

Rm 1201, Growne Plaza Qingdao 76,  
Xiang Gang Zhong Rd, Qingdao,  
266071 China  
Tel : +86-532-85779102  
E-mail : zhengguo.cui@samsung.com

#### Taipei Office

9F-1, Np. 399 Ruey Kuang Rd., Neihu  
District, Taipei City, Taiwan, 114  
Tel : +886-2-2656-8350  
E-mail : kevin0130.wang@samsung.com

#### Singapore office

Samsung Electro-Mechanics Private Limited  
3 Church Street Samsung Hub #23-01  
Singapore 049483  
Tel : +65-6933-2630  
E-mail : alvin.koh@samsung.com

#### Bangkok office

24180 Wellgrow Industrial Estate, 93 Moo 5,  
Bangsamak A. Bangpakong, Chachoensao,  
Thailand  
Tel : +66-38-562-110  
E-mail : kyunghoon1.leel@samsung.com

#### Japan office

108-0075 Minato-ku Tokyo Kounan 2-16-4  
Shinagawa Grand Cnetral Tower 9F, Japan  
Tel : +81-3-6369-6452  
E-mail : hikota.suga@samsung.com

### • America sales office

#### Irvine office

3333 Michelson Drive, Suite 500, Irvine,  
CA 92612, USA  
Tel : +1-949-797-8016  
E-mail : andrew.skelly@samsung.com

#### San Jose office

601, McCarthy Blvd., San Jose, CA 95035, USA  
Tel : +1-408-544-4552  
E-mail : jay.pauer@samsung.com

#### Chicago office

1870 West Winchester Rd, Suite 247,  
Libertyville IL 60048, USA  
Tel : +1-847-549-9424  
E-mail : sweety@samsung.com

### • Europe sales offices

#### London office

KT130NY 2nd floor, No 5. No 5. The Heights,  
Brooklands, Weybridge Surrey, England  
Tel : +44-1932-826-811  
E-mail : river.leel@samsung.com

#### Helsinki office

02600, Lars Sonckin Kaari 14, Espoo, Finland  
Tel : +358-9-853-1132  
E-mail : jouni.riittanen@samsung.com

### • Domestic Distributors

#### Korchip Corporation

359, Manan-ro, Manan-gu, Anyang-si,  
Gyeonggi-do, Korea  
Tel : +82-31-361-8100  
E-mail : parts@korchip.com

#### SAMT

315, Yeongdong-daero, Gangnam-gu, Seoul,  
Korea  
Tel : +82-2-3458-9000  
E-mail : info@sammt.com

#### CHUNGMAC

40-3, Gokseon-ro 49beon-gil, Gwonseon-gu,  
Suwon-si, Gyeonggi-do, Korea  
Tel : +82-31-234-2367  
E-mail : webmaster@chungmac.co.kr

#### YOUNGDUK

632, Seobusaet-gil, Geumcheon-gu, Seoul,  
Korea  
Tel : +82-2-2107-7860  
E-mail : dryblood@hanmail.net

## X-ON Electronics

Largest Supplier of Electrical and Electronic Components

*Click to view similar products for [samsung manufacturer](#):*

Other Similar products are found below :

[DA61-04475B](#) [KM44C4100BK-60](#) [CL05C160JB5NCNC](#) [CL05C1R8CB5NNNC](#) [CL05C221JA5NNNC](#) [CL10B822KB8NNNC](#)  
[CL10C680FB8NNNC](#) [CL21B223KCFNNNG](#) [CL21C151FBANNWC](#) [CL21C1R2BBAANNC](#) [CL21C1R5CBAANNC](#)  
[CL21C8R2CBAANNC](#) [CL21C8R2CBANNNC](#) [CL31C223JBHNNNE](#) [M471B5673EH1-CH900](#) [K4H510838B-TCB3](#) [CL10C820JB8NNND](#)  
[RC1608F86R6CS](#) [CL31C120JBCNNNC](#) [CL21CR47BBANNNC](#) [CL21C150JBANNNC](#) [CL10C102JA8NNNC](#) [CL10B104JO8NNNC](#)  
[CL32C103JBFNNNE](#) [CL31C271JGFNNNE](#) [CL31B223JBCNNNC](#) [CL21C221JDCNFNC](#) [CL21B223KBANNWC](#) [CL10B563KB8NFNC](#)  
[CL10B473KB8SFNC](#) [CL10B122KB8NFNC](#) [SI-B8T171550WW](#) [SL-B8V2N70LAWW](#) [BN96-35590A](#) [BN96-31876D](#) [DC97-15103A](#) [DA67-](#)  
[02638B](#) [BN96-32239D](#) [BN39-02189A](#) [BN39-02190A](#) [DA61-08574A](#) [DA97-17215A](#) [DC47-00027F](#) [AH59-02748B](#) [3903-001209](#)  
[RF062PJ150CS](#) [CL10A335MQ8NNNC](#) [CL10B823KA8NNNC](#) [CL10C680JB8NFNC](#) [CL31B681KHFNFNE](#)