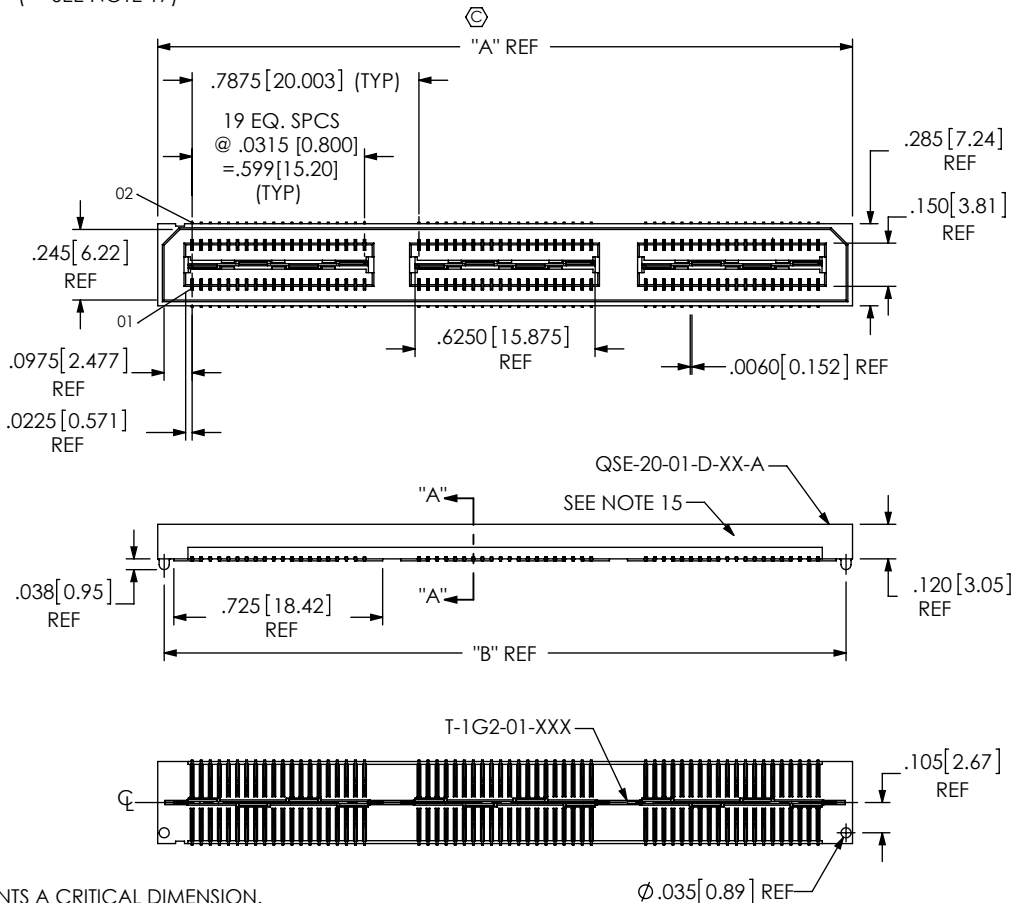

TABLE 2		
No OF POS	"A"	"B"
-020	.838 [21.27]	.793 [20.13]
-040	1.625 [41.28]	1.580 [40.13]
-060	2.413 [61.28]	2.368 [60.13]
*-080	3.200 [81.28]	3.155 [80.14]
*-100	3.988 [101.28]	3.943 [100.14]

(* = SEE NOTE 17)

TABLE 1	
No OF POS	COPLANARITY INCLUDING GP
-020 THRU -040	.004[0.10]
-060, *-080, *-100	.006[0.15]

(* = SEE NOTE 17)



- NOTES:
1. \odot REPRESENTS A CRITICAL DIMENSION.
 2. MINIMUM CONTACT RETENTION: 8 OZ
 3. MINIMUM GROUND PLANE RETENTION: 8 OZ
 4. PARTS ARE MOLDED TO POSITION.
 5. DELETED.
 6. MAXIMUM VARIANCE: .002[0.51].
 7. DIMENSION APPLIES TO CONTACTS & GROUND PLANE.
 8. -L PLATING CAN BE SUBSTITUTED FOR -F PLATING, -G PLATED GROUND PLANE CAN BE SUBSTITUTED FOR -F PLATED GROUND PLANE.
 9. GROUND PLANE PRESS HEIGHT MUST BE .003 [0.08] LESS THAN THE MAX HEIGHT OR .001 [0.03] GREATER THAN THE MINIMUM HEIGHT OF THE SOCKETS.
 10. MINIMUM SUB-SC-05-01-XX RETENTION: 1 LB IN BODY.
 11. MAY SUB C-126-01-XXX FOR C-126-21-XXX.
 12. NOTE DELETED.
 13. FOR -080, -100 POSITIONS USE C-269-11-XXX. DO NOT SUB C-126.
 14. DUE TO THE HIGH AMOUNT OF INSERTION FORCE NEEDED, THE -LC OPTION IS NOT COMPATIBLE WITH AUTO PLACEMENT. SAMTEC RECOMMENDS MANUAL PLACEMENT FOR ALL ASSEMBLIES WITH THE -LC OPTION.
 15. SIDE WALLS ARE RIBBED AS NECESSARY TO CONTROL BOW.
 16. CHECK ONCE PER BANK ALTERNATING SIDES FOR MULTIPLE BANK PARTS.
 17. AVAILABLE FOR EXISTING CUSTOMERS ONLY.

QSE-XXX-01-XXX-D-XXX

No OF POSITIONS
-020, -040, -060
*-080, *-100 (PER ROW)
(* = SEE NOTE & 17)

LEAD STYLE
-01: .1280[3.251]

PLATING SPECIFICATION

- (SEE NOTES 8, 11 & 13)
- F: 3 μ " SELECTIVE GOLD IN CONTACT AREA, MATTE TIN ON TAIL (USE C-126-21-F, T-1G2-01-F) (SEE NOTE 8)
- L: 10 μ " SELECTIVE GOLD IN CONTACT AREA, MATTE TIN ON TAIL (USE C-126-21-L, T-1G2-01-L)
- H: 30 μ " GOLD IN CONTACT AREA, 3 μ " GOLD ON TAIL (USE C-126-21-H, T-1G2-01-G)
- C: 50 μ " ELECTRO POLISHED SELECTIVE GOLD IN CONTACT AREA, MATTE TIN ON TAIL (USE C-126-21-C, T-1G2-01-L)
- STL: 30 μ " SELECTIVE GOLD IN CONTACT AREA, TIN LEAD (90/10 \pm 5%) ON TAIL (USE C-126-21-STL, T-1G2-01-STL)
- FTL: 3 μ " SELECTIVE GOLD IN CONTACT AREA, TIN LEAD (90/10 \pm 5%) ON TAIL (USE C-126-21-FTL, T-1G2-01-FTL)
- LTL: 10 μ " SELECTIVE GOLD IN CONTACT AREA, TIN LEAD (90/10 \pm 5%) ON TAIL (USE C-126-21-LTL, T-1G2-01-LTL)
- S: 30 μ " SELECTIVE GOLD IN CONTACT AREA, MATTE TIN ON TAIL (USE C-126-21-S, T-1G2-01-L)

OPTION

- A: ALIGNMENT PINS (USE QSE-20-XX-D-XX-A) (NOT AVAILABLE WITH -LC OPTION)
- LC: LOCKING CLIPS (SEE NOTE 14) (USE LC-08-1M-01, SEE FIG 2, SHT 2) (NOT AVAILABLE WITH -A OPTION)
- GP: GUIDE POSTS (SEE FIG 4, SHT 3) (USE QSE-20-01-D-XX-X-GP) (T & R PACKAGING: 40 POS MAX)
- K: POLYIMIDE FILM (USE K-DOT-.325-.450-.005) (SEE FIG 3, SHT 2)
- TR: TAPE & REEL (60 POS MAX) (SEE FIG 8, SHT 5) (40 POS MAX -GP OPTION)
- FL: FRICTION LOCKS (SEE FIG 5, SHT 3) (NOT AVAILABLE WITH -GP)
- RT1: RETENTION OPTION (MUST USE -A OPTION) (USE QSE-20-01-D-XX-A-RT1 & SUB-SC-05-01-FF) (SEE FIG 6, SHT 4) (NOT AVAILABLE WITH -LC, -GP, OR -FL) (NOT AVAILABLE WITH -100 POS)
- L: LATCHING OPTION (40 POS MAX) (SEE FIG 7, SHT 4) (MUST USE -A OPTION) (NOT AVAILABLE WITH -LC, -GP, -FL, OR -RT1)

ROW SPECIFICATION

- D: DOUBLE (USE QSE-20-XX-D-XXX)
- No OF BANKS

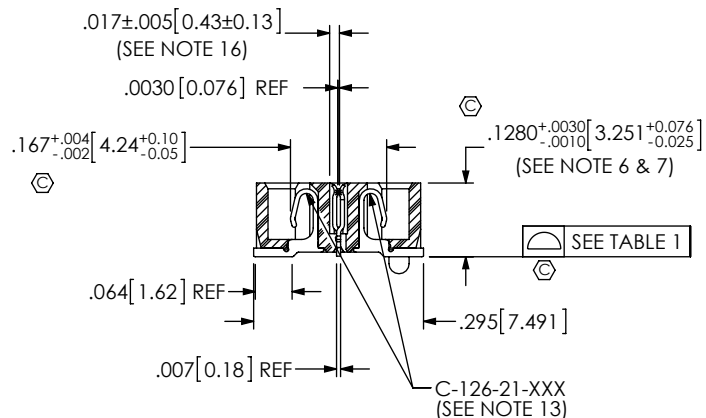

FIG 1

-A: ALIGNMENT PIN OPTION (QSE-060-01-XXX-D-A SHOWN)

UNLESS OTHERWISE SPECIFIED, DIMENSIONS ARE IN INCHES. TOLERANCES ARE: DECIMALS ANGLES .XX: \pm .01[.3] .XXX: \pm .005[.13] .XXXX: \pm .0020[.051]	PROPRIETARY NOTE THIS DOCUMENT CONTAINS INFORMATION CONFIDENTIAL AND PROPRIETARY TO SAMTEC, INC. AND SHALL NOT BE REPRODUCED OR TRANSFERRED TO OTHER DOCUMENTS OR DISCLOSED TO OTHERS OR USED FOR ANY PURPOSE OTHER THAN THAT WHICH IT WAS OBTAINED WITHOUT THE EXPRESSED WRITTEN CONSENT OF SAMTEC, INC.		
		520 PARK EAST BLVD. NEW ALBANY, IN 47150 PHONE: 812-944-6733 FAX: 812-948-5047 e-Mail: info@SAMTEC.com code 55322	
MATERIAL: DO NOT SCALE DRAWING SHEET SCALE: 1:5.1 INSULATOR: LCP, UL94V-0; COLOR: BLACK CONTACT: PHOS BRONZE GROUND PLANE: PHOS BRONZE		DESCRIPTION: .8mm DOUBLE ROW HS SOCKET ASSEMBLY	
DWG. NO. QSE-XXX-01-XXX-D-XXX		BY: ERIC M 05/20/1999 SHEET 1 OF 5	

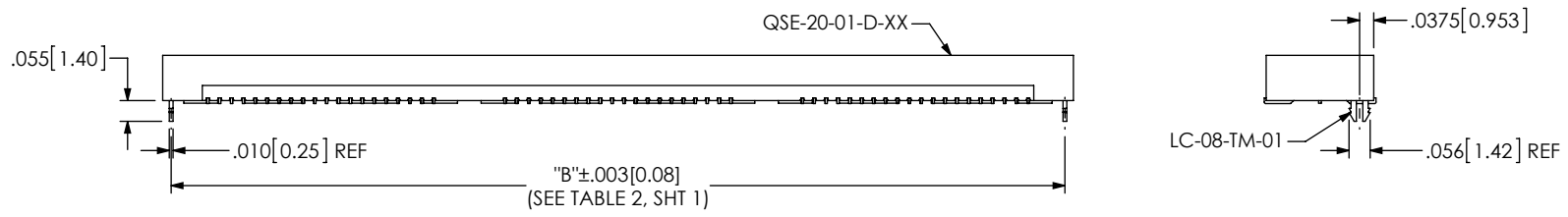

FIG 2
 -LC: LOCKING CLIP OPTION
 (QSE-060-01-XXX-D-LC SHOWN)
 (DIFFERENT AS SHOWN, OTHERWISE SAME AS FIG 1)

TABLE 3

No OF POS	"R"				"S"			
	-LC, -A, -FL	-GP	-RT1	-L	-LC, -A, -FL	-GP	-RT1	-L
-020	.839 [21.31]	1.216 [30.89]	1.438 [36.51]	1.048 [26.61]	.257 [6.53]	.446 [11.32]	.556 [14.13]	.361 [9.18]
-040	1.627 [41.31]	2.004 [50.89]	2.225 [56.52]	1.835 [46.61]	.651 [16.53]	.839 [21.32]	.950 [24.13]	.755 [19.18]
-060	2.417 [61.38]	2.791 [70.89]	3.013 [76.52]	N/A	1.046 [26.56]	1.233 [31.32]	1.344 [34.13]	N/A
*-080	3.204 [81.38]	3.579 [90.89]	3.800 [96.52]	N/A	1.440 [36.56]	1.627 [41.32]	1.738 [44.13]	N/A
*-100	3.991 [101.37]	4.366 [110.90]	N/A	N/A	1.833 [46.56]	2.021 [51.32]	N/A	N/A

(* = SEE NOTE 17)

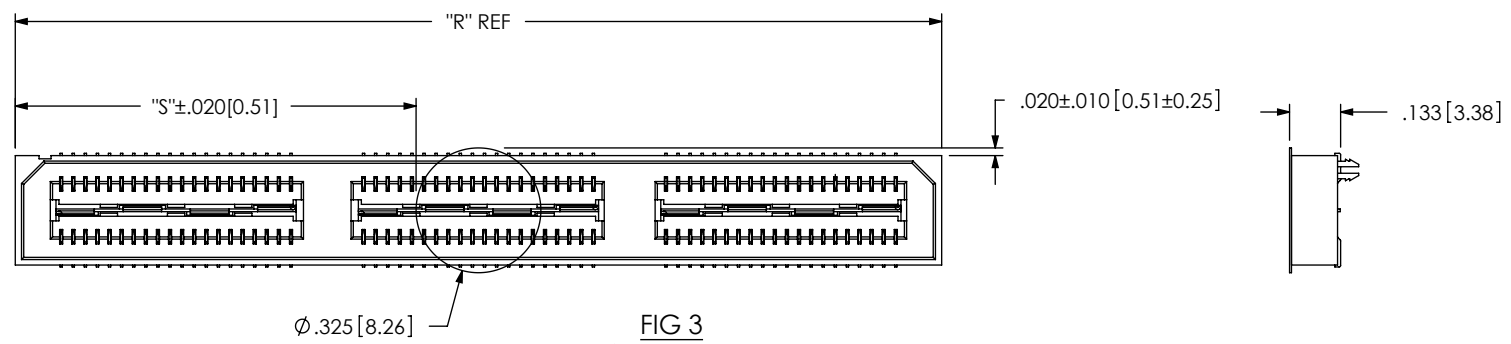



FIG 3
 -K: POLYIMIDE FILM PAD
 (K-DOT-.325-.450-.005)

F:\DWG\MISC\MKTG\QSE-XXX-01-XXX-D-XXX-MKT.SLDDRW

<p>PROPRIETARY NOTE THIS DOCUMENT CONTAINS INFORMATION CONFIDENTIAL AND PROPRIETARY TO SAMTEC, INC. AND SHALL NOT BE REPRODUCED OR TRANSFERRED TO OTHER DOCUMENTS OR DISCLOSED TO OTHERS OR USED FOR ANY PURPOSE OTHER THAN THAT WHICH IT WAS OBTAINED WITHOUT THE EXPRESSED WRITTEN CONSENT OF SAMTEC, INC.</p> <p>DO NOT SCALE DRAWING</p> <p>SHEET SCALE: 2:1</p>		
	<p>520 PARK EAST BLVD, NEW ALBANY, IN 47150 PHONE: 812-944-6733 FAX: 812-948-5047 e-Mail: info@SAMTEC.com code 55322</p>	
	<p>DESCRIPTION: .8mm DOUBLE ROW HS SOCKET ASSEMBLY</p>	
	<p>DWG. NO. QSE-XXX-01-XXX-D-XXX</p>	
<p>BY: ERIC M 05/20/1999</p>		<p>SHEET 2 OF 5</p>

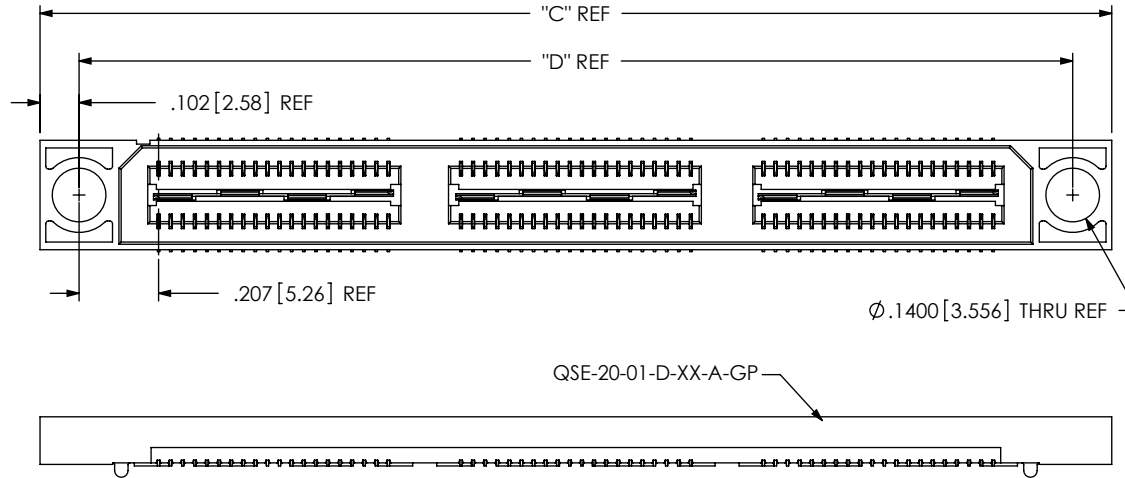
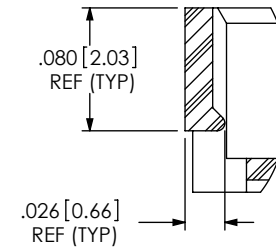
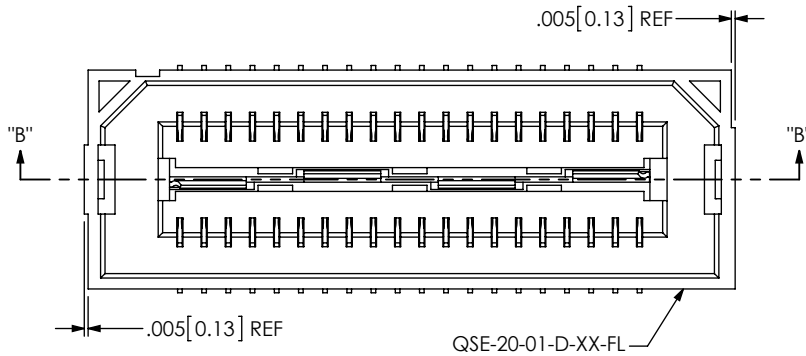

TABLE 4		
POS	"C"	"D"
-020	1.216 [30.89]	1.013 [25.72]
-040	2.004 [50.89]	1.800 [45.72]
-060	2.791 [70.89]	2.588 [65.72]
*-080	3.579 [90.89]	3.375 [85.73]
*-100	4.366 [110.90]	4.163 [105.73]

(* = SEE NOTE 17)

FIG 4
 -GP: GUIDE POST OPTION
 (QSE-060-01-XXX-D-A-GP SHOWN)
 (DIFFERENT AS SHOWN, OTHERWISE SAME AS FIG 1)
 (40 POS MAX WITH T & R PACKAGING)



DETAIL 'C'
 SCALE 8 : 1

FIG 5
 -FL: FRICTION LOCKS
 (QSE-020-01-XXX-D-FL SHOWN)
 (DIFFERENT AS SHOWN, OTHERWISE SAME AS FIG 1)
 (NOT AVAILABLE WITH -GP OPTION)

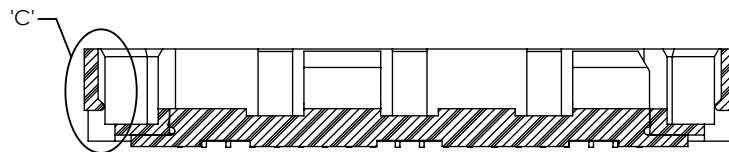

SECTION "B"-"B"
 SCALE 4 : 1

PROPRIETARY NOTE
 THIS DOCUMENT CONTAINS INFORMATION
 CONFIDENTIAL AND PROPRIETARY TO
 SAMTEC, INC. AND SHALL NOT BE REPRODUCED
 OR TRANSFERRED TO OTHER DOCUMENTS OR
 DISCLOSED TO OTHERS OR USED FOR ANY
 PURPOSE OTHER THAN THAT WHICH IT WAS
 OBTAINED WITHOUT THE EXPRESSED WRITTEN
 CONSENT OF SAMTEC, INC.

DO NOT SCALE DRAWING

SHEET SCALE: 2:1

samtec

520 PARK EAST BLVD, NEW ALBANY, IN 47150
 PHONE: 812-944-6733 FAX: 812-948-5047
 e-Mail info@SAMTEC.com code 55322

DESCRIPTION:
 .8mm DOUBLE ROW HS SOCKET ASSEMBLY

DWG. NO.
QSE-XXX-01-XXX-D-XXX

BY: ERIC M 05/20/1999 SHEET 3 OF 5

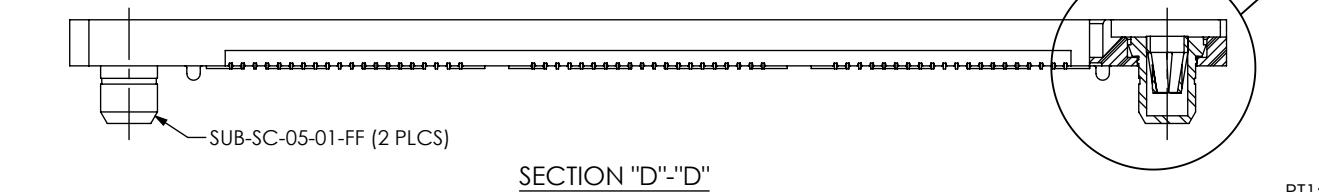
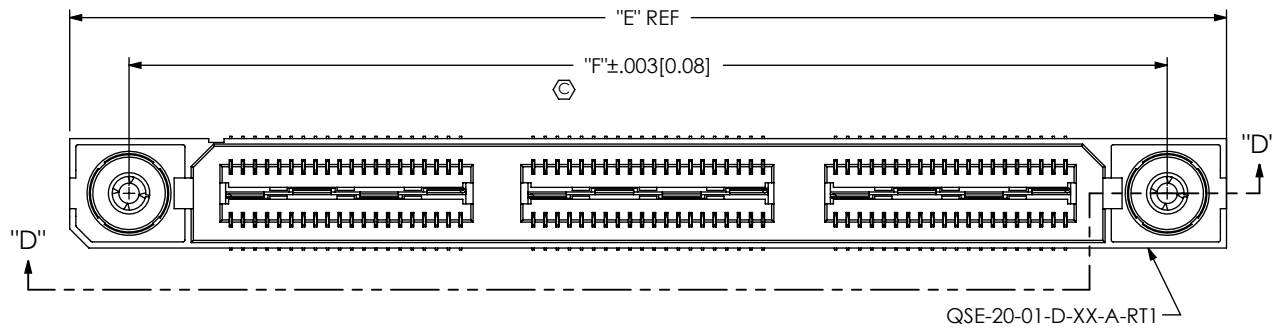

POS	"E"	"F"
-020	1.438 [36.51]	1.129 [28.66]
-040	2.225 [56.52]	1.916 [48.67]
-060	3.013 [76.52]	2.704 [68.67]
*-080	3.800 [96.52]	3.491 [88.67]
*-100	N/A	N/A

(* = SEE NOTE 17)

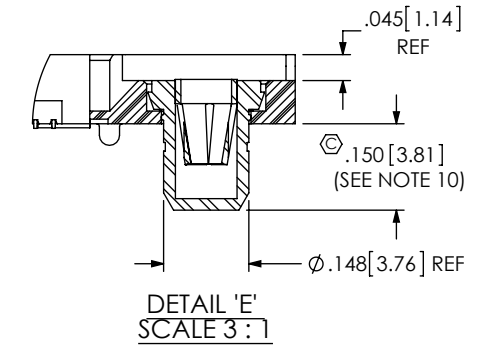
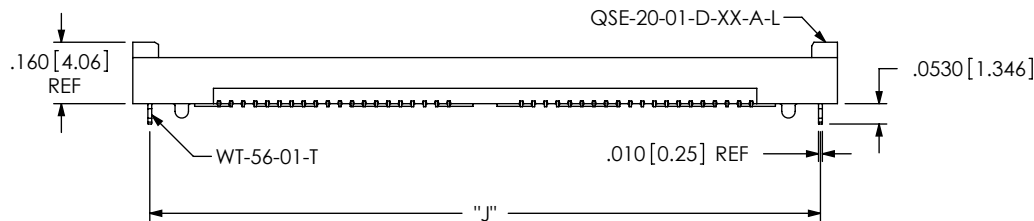
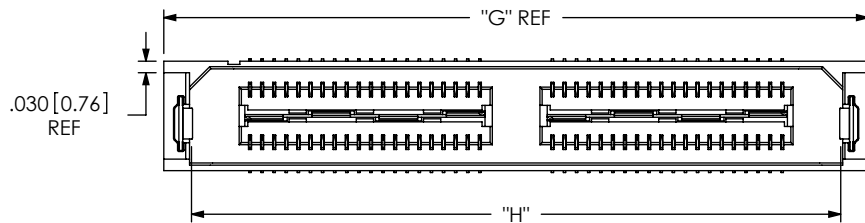

FIG 6
 -RT1: RETENTION OPTION
 (QSE-060-01-XXX-D-A-RT1 SHOWN)
 (DIFFERENT AS SHOWN, OTHERWISE SAME AS FIG 1)
 (MUST USE -A OPTION)
 (NOT AVAILABLE WITH -LC, -GP, OR -FL OPTIONS)
 (NOT AVAILABLE WITH -100 POS)



POS	"G"	"H"	"J"
-020	1.048 [26.61]	.897 [22.78]	.959 [24.36]
-040	1.835 [46.61]	1.684 [42.78]	1.747 [44.36]
-060	N/A	N/A	N/A
*-080	N/A	N/A	N/A
*-100	N/A	N/A	N/A

(* = SEE NOTE 17)

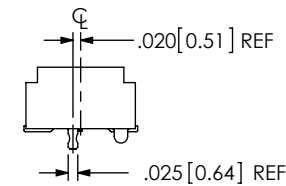

FIG 7
 -L: LATCHING OPTION
 (QSE-040-01-XXX-D-A-L SHOWN)
 (DIFFERENT AS SHOWN, OTHERWISE SAME AS FIG 1)
 (MUST USE -A OPTION) (40 POS MAX)
 (NOT AVAILABLE WITH -LC, -GP, -FL, OR -RT1 OPTIONS)

PROPRIETARY NOTE
 THIS DOCUMENT CONTAINS INFORMATION
 CONFIDENTIAL AND PROPRIETARY TO
 SAMTEC, INC. AND SHALL NOT BE REPRODUCED
 OR TRANSFERRED TO OTHER DOCUMENTS OR
 DISCLOSED TO OTHERS OR USED FOR ANY
 PURPOSE OTHER THAN THAT WHICH IT WAS
 OBTAINED WITHOUT THE EXPRESSED WRITTEN
 CONSENT OF SAMTEC, INC.

DO NOT SCALE DRAWING

SHEET SCALE: 2:1



520 PARK EAST BLVD. NEW ALBANY, IN 47150
 PHONE: 812-944-6733 FAX: 812-948-5047
 e-Mail info@SAMTEC.com code 55322

DESCRIPTION:
 .8mm DOUBLE ROW HS SOCKET ASSEMBLY

DWG. NO.
QSE-XXX-01-XXX-D-XXX

BY: ERIC M 05/20/1999 SHEET 4 OF 5

FIG 8
 -TR: PACKAGING OPTION
 (QSE-060-01-XXX-D-LC-TR SHOWN)
 (DIFFERENT AS SHOWN, OTHERWISE SAME AS FIG 1)
 (60 POS MAX)
 (40 POS MAX WITH -GP OPTION)

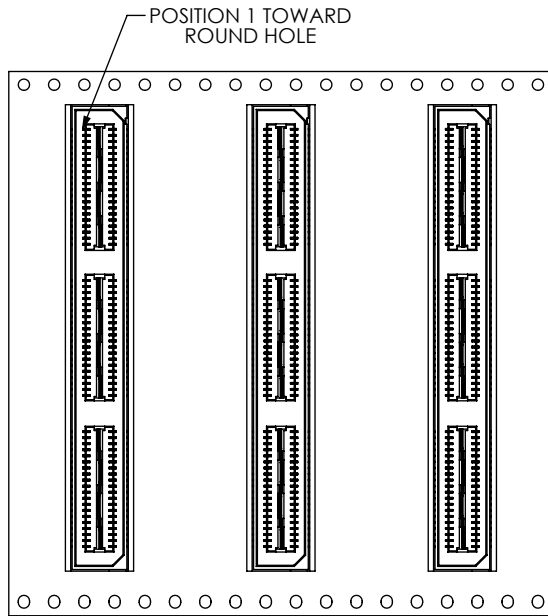

USER DIRECTION OF UNREELING →
 POCKET NOT DETAILED

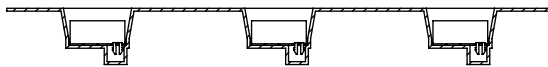

PROPRIETARY NOTE
 THIS DOCUMENT CONTAINS INFORMATION
 CONFIDENTIAL AND PROPRIETARY TO
 SAMTEC, INC. AND SHALL NOT BE REPRODUCED
 OR TRANSFERRED TO OTHER DOCUMENTS OR
 DISCLOSED TO OTHERS OR USED FOR ANY
 PURPOSE OTHER THAN THAT WHICH IT WAS
 OBTAINED WITHOUT THE EXPRESSED WRITTEN
 CONSENT OF SAMTEC, INC.

DO NOT SCALE DRAWING

SHEET SCALE: 2:1



520 PARK EAST BLVD, NEW ALBANY, IN 47150
 PHONE: 812-944-6733 FAX: 812-948-5047
 e-Mail info@SAMTEC.com code 55322

DESCRIPTION: .8mm DOUBLE ROW HS SOCKET ASSEMBLY

DWG. NO. QSE-XXX-01-XXX-D-XXX

BY: ERIC M 05/20/1999 SHEET 5 OF 5

X-ON Electronics

Largest Supplier of Electrical and Electronic Components

Click to view similar products for [Board to Board & Mezzanine Connectors](#) category:

Click to view products by [Samtec](#) manufacturer:

Other Similar products are found below :

[10135583-642402LF](#) [89885-310LF](#) [589158040000018](#) [6-1393048-0](#) [68683-613](#) [MDF7-12DP-2.54DSA](#) [MDF7-18P-2.54DSA\(01\)](#) [MDF7-20DP-2.54DSA](#) [MDF7-26D-2.54DSA\(55\)](#) [MDF7-3P-2.54DSA\(01\)](#) [MDF7B-3P-2.54DSA\(55\)](#) [MDF7C-11P-2.54DSA\(55\)](#) [MDF7C-18P-2.54DSA\(55\)](#) [MDF7C-5P-2.54DSA\(01\)](#) [MDF7P-5P-2.54DSA\(55\)](#) [75234-0516](#) [FCN-230C068-11](#) [FCN-268F012-G/BD](#) [FCN-268F036-G/BD](#) [FCN-268M012-G/0D](#) [FCN-268M024-G/1D](#) [FCN-360C008-C](#) [FCN-360C040-C](#) [FCN-723J004/1](#) [MIS-048-01-F-D-DP-K](#) [832-10-034-10-001000](#) [93696-325LF](#) [11828-1FA](#) [AXK630345P](#) [18097-0013](#) [ICA-328STT](#) [2007042-2](#) [304400-2](#) [FCN-214Q030-G/0](#) [FCN-215Q040-G/0](#) [FCN-230C068-ESA](#) [FCN-234P048-G/0](#) [FCN-235D050-G/C](#) [FCN-360A3](#) [FCN-360C040-B](#) [210-93-314-41-105000](#) [2-22603-0](#) [379-064-521-202](#) [MDF7-12P-2.54DSA\(01\)](#) [MDF7-16P-2.54DS\(56\)](#) [MDF7-40DP-2.54DSA\(55\)](#) [MDF7-8P-2.54DSA\(55\)](#) [MDF7B-16P-2.54DSA\(55\)](#) [AXG720047](#) [5031084030](#)