



Is Now Part of



ON Semiconductor®

To learn more about ON Semiconductor, please visit our website at
www.onsemi.com

Please note: As part of the Fairchild Semiconductor integration, some of the Fairchild orderable part numbers will need to change in order to meet ON Semiconductor's system requirements. Since the ON Semiconductor product management systems do not have the ability to manage part nomenclature that utilizes an underscore (_), the underscore (_) in the Fairchild part numbers will be changed to a dash (-). This document may contain device numbers with an underscore (_). Please check the ON Semiconductor website to verify the updated device numbers. The most current and up-to-date ordering information can be found at www.onsemi.com. Please email any questions regarding the system integration to Fairchild_questions@onsemi.com.

ON Semiconductor and the ON Semiconductor logo are trademarks of Semiconductor Components Industries, LLC dba ON Semiconductor or its subsidiaries in the United States and/or other countries. ON Semiconductor owns the rights to a number of patents, trademarks, copyrights, trade secrets, and other intellectual property. A listing of ON Semiconductor's product/patent coverage may be accessed at www.onsemi.com/site/pdf/Patent-Marking.pdf. ON Semiconductor reserves the right to make changes without further notice to any products herein. ON Semiconductor makes no warranty, representation or guarantee regarding the suitability of its products for any particular purpose, nor does ON Semiconductor assume any liability arising out of the application or use of any product or circuit, and specifically disclaims any and all liability, including without limitation special, consequential or incidental damages. Buyer is responsible for its products and applications using ON Semiconductor products, including compliance with all laws, regulations and safety requirements or standards, regardless of any support or applications information provided by ON Semiconductor. "Typical" parameters which may be provided in ON Semiconductor data sheets and/or specifications can and do vary in different applications and actual performance may vary over time. All operating parameters, including "Typicals" must be validated for each customer application by customer's technical experts. ON Semiconductor does not convey any license under its patent rights nor the rights of others. ON Semiconductor products are not designed, intended, or authorized for use as a critical component in life support systems or any FDA Class 3 medical devices or medical devices with a same or similar classification in a foreign jurisdiction or any devices intended for implantation in the human body. Should Buyer purchase or use ON Semiconductor products for any such unintended or unauthorized application, Buyer shall indemnify and hold ON Semiconductor and its officers, employees, subsidiaries, affiliates, and distributors harmless against all claims, costs, damages, and expenses, and reasonable attorney fees arising out of, directly or indirectly, any claim of personal injury or death associated with such unintended or unauthorized use, even if such claim alleges that ON Semiconductor was negligent regarding the design or manufacture of the part. ON Semiconductor is an Equal Opportunity/Affirmative Action Employer. This literature is subject to all applicable copyright laws and is not for resale in any manner.



April 2016

HUFA76413DK8T_F085

N-Channel Logic Level UltraFET® Power MOSFET 60V, 4.8A, 56mΩ

General Description

These N-Channel power MOSFETs are manufactured using the innovative UltraFET® process. This advanced process technology achieves the lowest possible onresistance per silicon area, resulting in outstanding performance. This device is capable of withstanding high energy

in the avalanche mode and the diode exhibits very low reverse recovery time and stored charge. It was designed for use in applications where power efficiency is important, such as switching regulators, switching convertors, motor drivers, relay drivers, low-voltage bus switches, and power management in portable and battery-operated products.



Features

- 150°C Maximum Junction Temperature
- UIS Capability (Single Pulse and Repetitive Pulse)
- Ultra-Low On-Resistance $r_{DS(ON)} = 0.049\Omega$, $V_{GS} = 10V$
- Ultra-Low On-Resistance $r_{DS(ON)} = 0.056\Omega$, $V_{GS} = 5V$
- Qualified to AEC Q101
- RoHS Compliant

Applications

- Motor and Load Control
- Powertrain Management

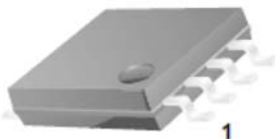

SO-8

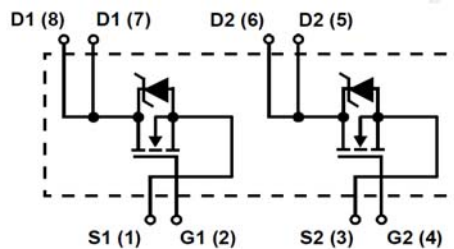

MOSFET Maximum Ratings $T_A = 25^\circ\text{C}$ unless otherwise noted

Symbol	Parameter	Ratings	Units
V_{DSS}	Drain to Source Voltage	60	V
V_{GS}	Gate to Source Voltage	± 16	V
I_D	Drain Current -Continuous ($T_C = 25^\circ\text{C}$, $V_{GS} = 10V$)	5.1	A
	-Continuous ($T_C = 25^\circ\text{C}$, $V_{GS} = 5V$)	4.8	
	-Continuous ($T_C = 125^\circ\text{C}$, $V_{GS} = 5V$, $R_{\theta JA} = 228^\circ\text{C/W}$)	1	
	-Pulsed	Figure 4	
E_{AS}	Single Pulse Avalanche Energy (Note 1)	260	mJ
P_D	Power Dissipation	2.5	W
	Derate Above 25°C	0.02	W/ $^\circ\text{C}$
T_J, T_{STG}	Operating and Storage Temperature	-55 to +150	$^\circ\text{C}$

Thermal Characteristics

$R_{\theta JA}$	Thermal Resistance Junction to Ambient SO-8 (Note 2)	50	$^\circ\text{C/W}$
	Thermal Resistance Junction to Ambient SO-8 (Note 3)	191	
	Thermal Resistance Junction to Ambient SO-8 (Note 4)	228	

Package Marking and Ordering Information

Device Marking	Device	Package	Reel Size	Tape Width	Quantity
76413DK8	HUFA76413DK8T_F085	SO-8	330mm	12mm	2500 units

Notes:

- 1: Starting $T_J = 25^\circ\text{C}$, $L = 20\text{mH}$, $I_{AS} = 5.1\text{A}$
- 2: $R_{\theta JA}$ is 50°C/W when mounted on a 0.5 in^2 copper pad on FR-4 at 1 second.
- 3: $R_{\theta JA}$ is 191°C/W when mounted on a 0.027 in^2 copper pad on FR-4 at 1000 seconds.
- 4: $R_{\theta JA}$ is 228°C/W when mounted on a 0.006 in^2 copper pad on FR-4 at 1000 seconds.
- 5: A suffix as "...F085P" has been temporarily introduced in order to manage a double source strategy as Fairchild has officially announced in Aug 2014.

Electrical Characteristics $T_J = 25^\circ\text{C}$ unless otherwise noted

Symbol	Parameter	Test Conditions	Min	Typ	Max	Units
--------	-----------	-----------------	-----	-----	-----	-------

Off Characteristics

BV_{DSS}	Drain to Source Breakdown Voltage	$I_D = 250 \mu\text{A}$, $V_{GS} = 0 \text{ V}$	60	-	-	V
I_{DSS}	Zero Gate Voltage Drain Current	$V_{DS} = 55 \text{ V}$, $V_{GS} = 0 \text{ V}$	-	-	1	μA
		$T_A = 150^\circ\text{C}$	-	-	250	
I_{GSS}	Gate to Source Leakage Current	$V_{GS} = \pm 16 \text{ V}$	-	-	± 100	nA

On Characteristics

$V_{GS(th)}$	Gate to Source Threshold Voltage	$V_{GS} = V_{DS}$, $I_D = 250 \mu\text{A}$	1	-	3	V
$r_{DS(on)}$	Static Drain to Source On Resistance	$I_D = 5.1 \text{ A}$, $V_{GS} = 10 \text{ V}$	-	0.041	0.049	Ω
		$I_D = 4.8 \text{ A}$, $V_{GS} = 5 \text{ V}$	-	0.048	0.056	
		$I_D = 4.8 \text{ A}$, $V_{GS} = 5 \text{ V}$, $T_A = 150^\circ\text{C}$	-	0.091	0.106	

Dynamic Characteristics

C_{iss}	Input Capacitance	$V_{DS} = 25 \text{ V}$, $V_{GS} = 0 \text{ V}$, $f = 1 \text{ MHz}$	-	620	-	pF	
C_{oss}	Output Capacitance		-	180	-	pF	
C_{rss}	Reverse Transfer Capacitance		-	30	-	pF	
$Q_{g(TOT)}$	Total Gate Charge at 10V	$V_{GS} = 0$ to 10 V	$V_{DD} = 30 \text{ V}$, $I_D = 4.8 \text{ A}$, $I_g = 1.0 \text{ mA}$	-	18	23	nC
$Q_{g(5)}$	Total Gate Charge at 5V	$V_{GS} = 0$ to 5 V		-	10	13	nC
$Q_{g(TH)}$	Threshold Gate Charge	$V_{GS} = 0$ to 1 V		-	0.6	0.8	nC
Q_{gs}	Gate to Source Charge			-	1.8	-	nC
Q_{gd}	Gate to Drain "Miller" Charge			-	5	-	nC

Switching Characteristics ($V_{GS}=5\text{V}$)

t_{on}	Turn-On Time	$V_{DD} = 30 \text{ V}$, $I_D = 1.0 \text{ A}$, $V_{GS} = 5 \text{ V}$, $R_{GS} = 16 \Omega$	-	-	44	ns
$t_{d(on)}$	Turn-On Delay Time		-	10	-	ns
t_r	Rise Time		-	19	-	ns
$t_{d(off)}$	Turn-Off Delay Time		-	45	-	ns
t_f	Fall Time		-	27	-	ns
t_{off}	Turn-Off Time		-	-	108	ns

Drain-Source Diode Characteristics

V_{SD}	Source to Drain Diode Forward Voltage	$I_{SD} = 4.8 \text{ A}$	-	-	1.25	V
		$I_{SD} = 2.4 \text{ A}$	-	-	1.0	
t_{rr}	Reverse Recovery Time	$I_{SD} = 4.8 \text{ A}$, $dI_{SD}/dt = 100 \text{ A}/\mu\text{s}$	-	-	43	ns
Q_{rr}	Reverse Recovery Charge		-	-	55	nC

Typical Characteristics $T_J = 25^\circ\text{C}$ unless otherwise noted

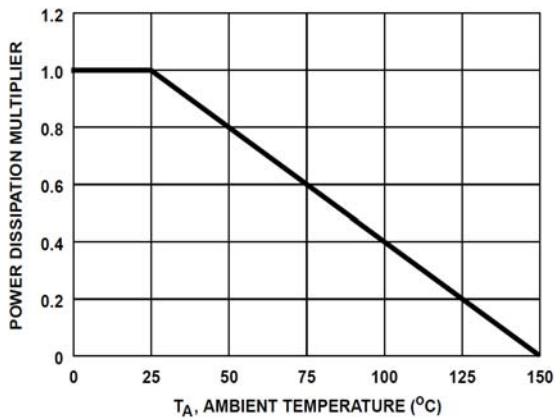

Figure 1. Normalized Power Dissipation vs. Ambient Temperature

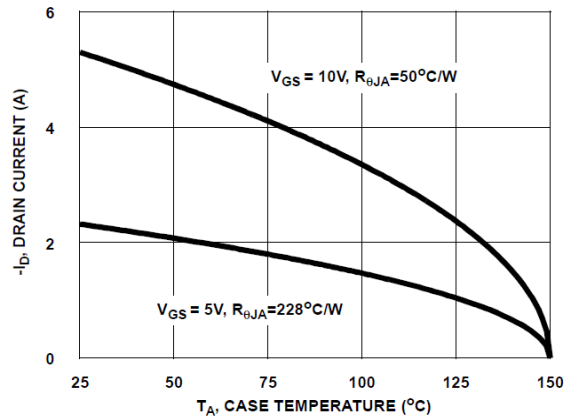

Figure 2. Maximum Continuous Drain Current vs. Case Temperature

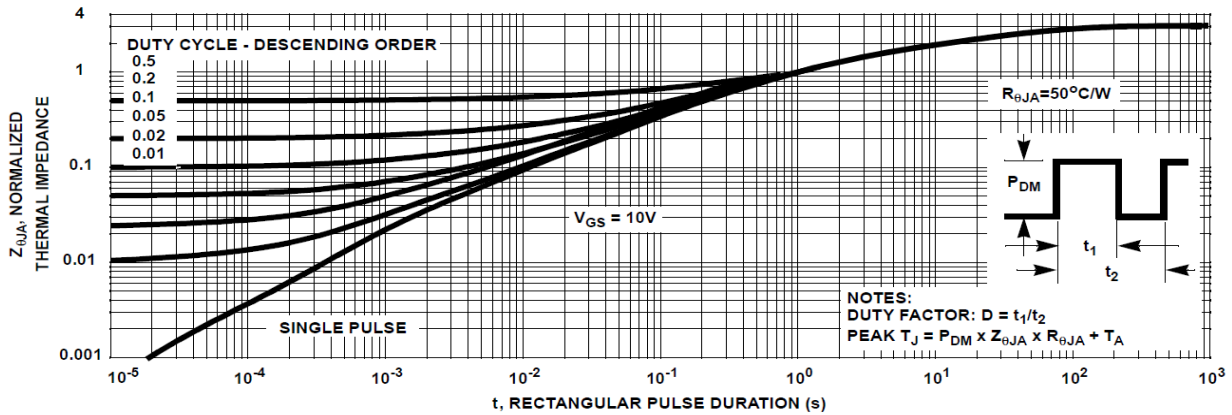

Figure 3. Normalized Maximum Transient Thermal Impedance

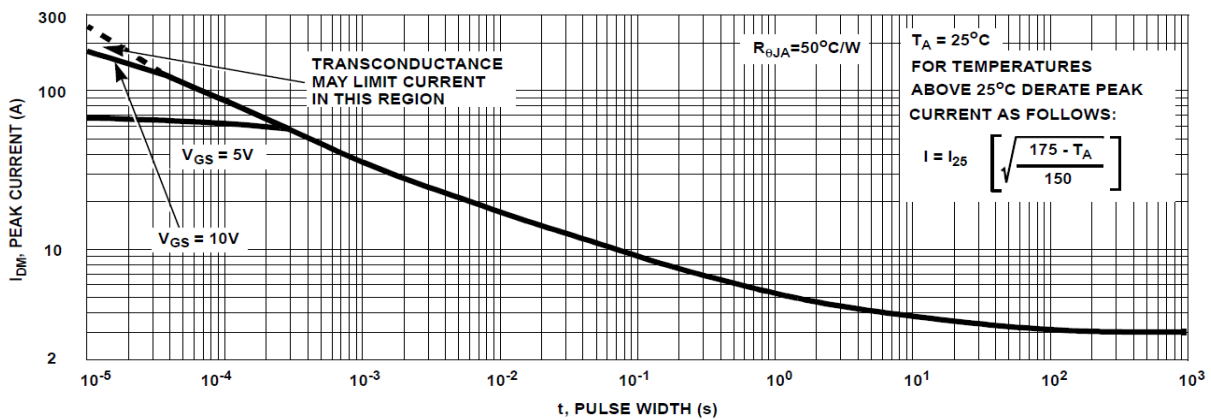

Figure 4. Peak Current Capability

Typical Characteristics $T_J = 25^\circ\text{C}$ unless otherwise noted

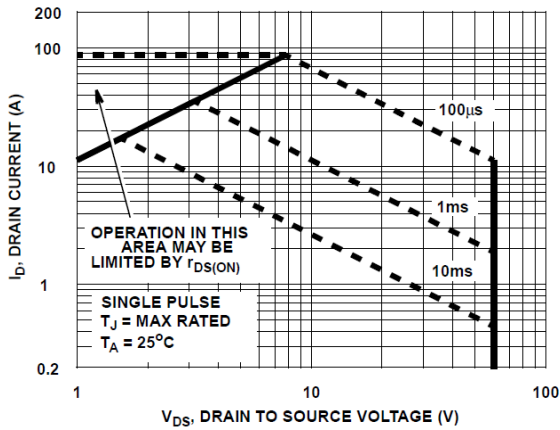

Figure 5. Forward Bias Safe Operating Area

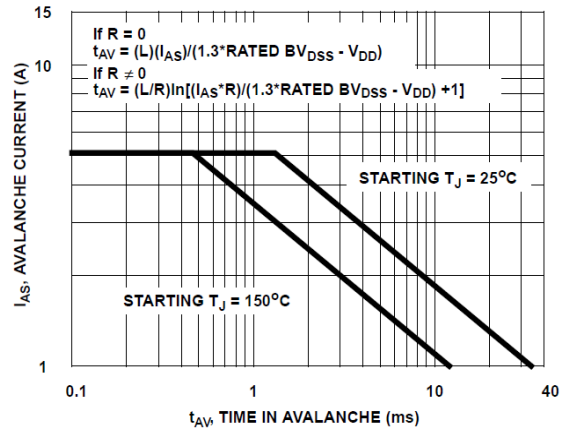

Figure 6. Unclamped Inductive Switching Capability

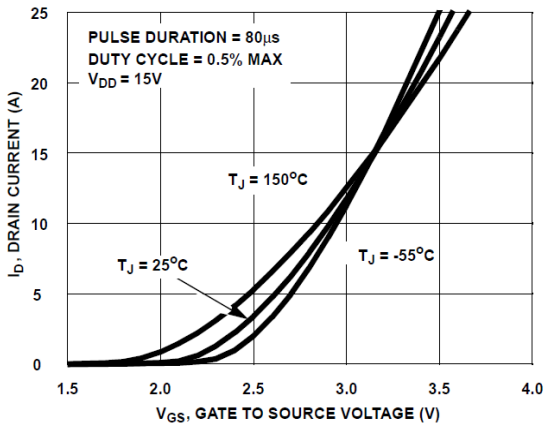

Figure 7. Transfer Characteristics

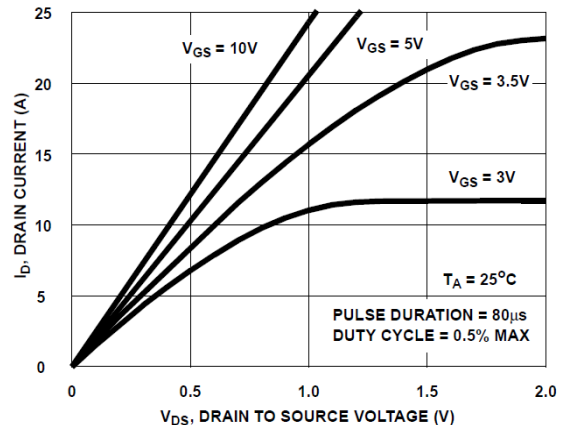

Figure 8. Saturation Characteristics

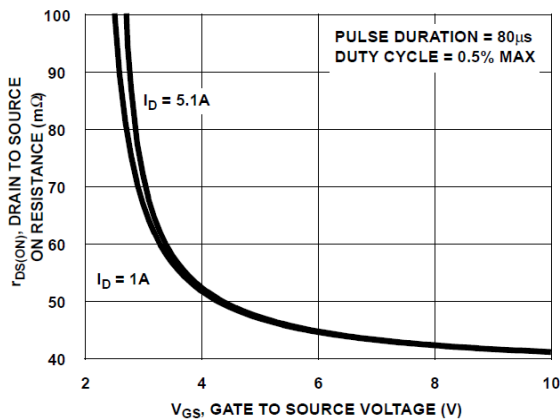

Figure 9. Drain to Source On Resistance vs. Gate Voltage and Drain Current

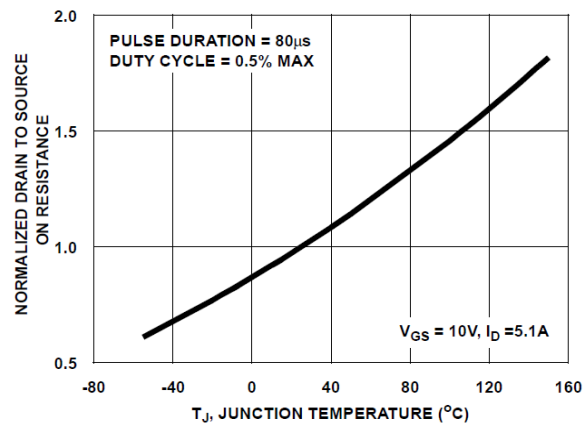

Figure 10. Normalized Drain to Source On Resistance vs. Junction Temperature

Typical Characteristics $T_J = 25^\circ\text{C}$ unless otherwise noted

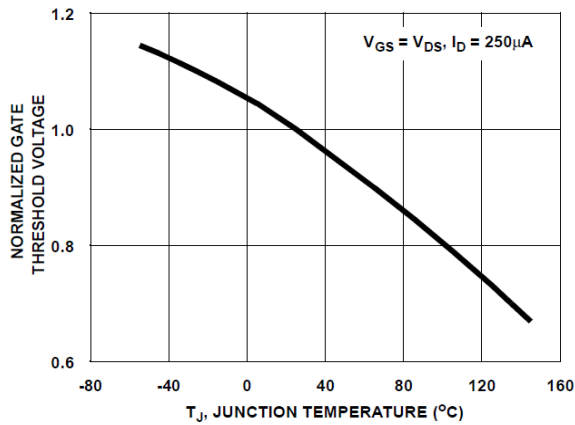

Figure 11. Normalized Gate Threshold Voltage vs. Junction Temperature

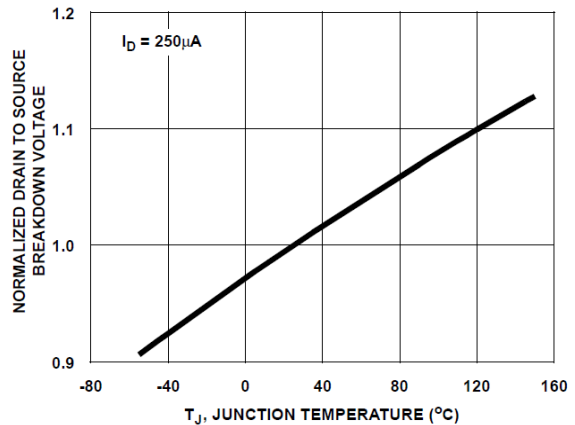

Figure 12. Normalized Drain to Source Breakdown Voltage vs. Junction Temperature

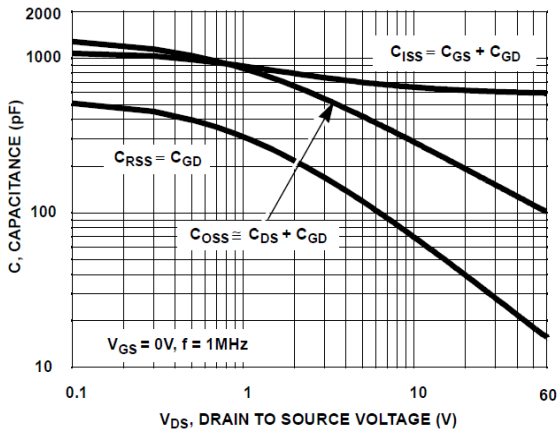

Figure 13. Capacitance vs. Drain to Source Voltage

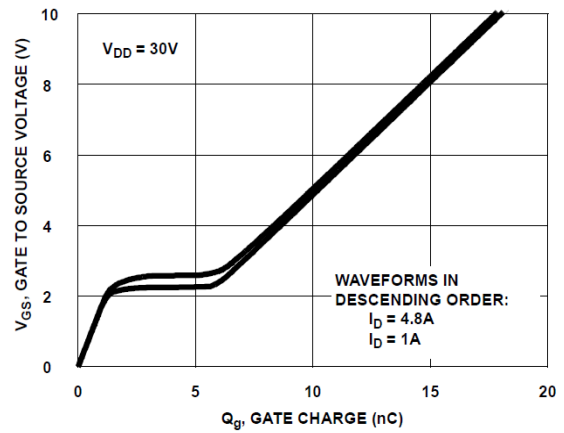

Figure 14. Gate Charge Waveforms for Constant Gate Currents

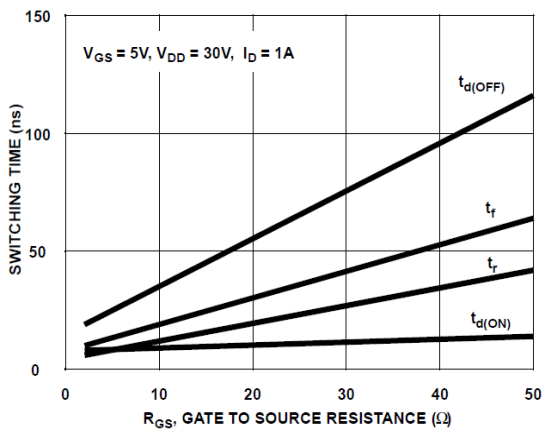
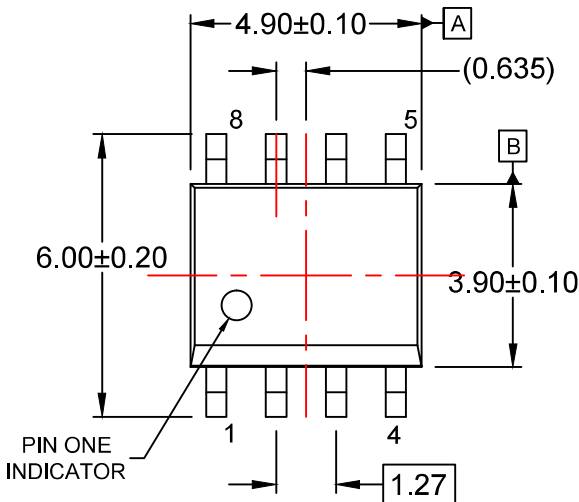
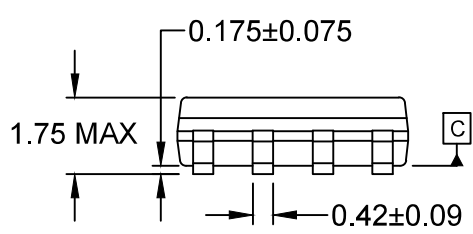
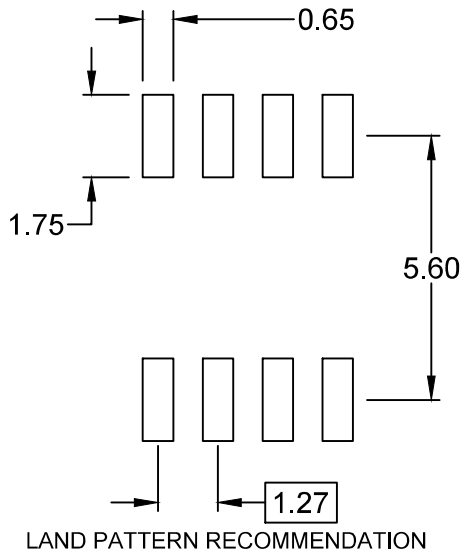

Figure 15. Switching Time vs Gate Resistance



⊕ 0.25(M) C B A



0.10

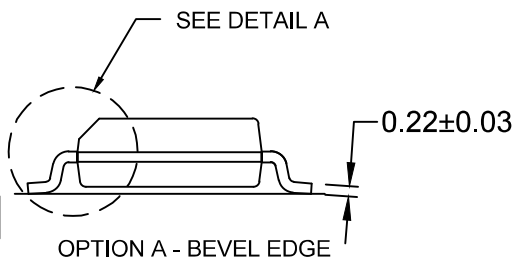

OPTION A - BEVEL EDGE

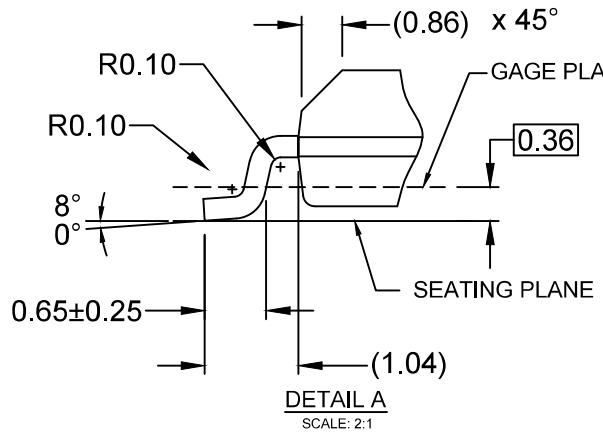

DETAIL A
SCALE: 2:1

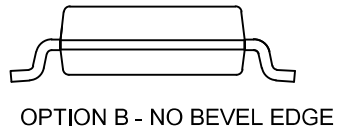

OPTION B - NO BEVEL EDGE

NOTES:

- A) THIS PACKAGE CONFORMS TO JEDEC MS-012, VARIATION AA.
- B) ALL DIMENSIONS ARE IN MILLIMETERS.
- C) DIMENSIONS DO NOT INCLUDE MOLD FLASH OR BURRS.
- D) LANDPATTERN STANDARD: SOIC127P600X175-8M
- E) DRAWING FILENAME: M08Arev16



ON Semiconductor and  are trademarks of Semiconductor Components Industries, LLC dba ON Semiconductor or its subsidiaries in the United States and/or other countries. ON Semiconductor owns the rights to a number of patents, trademarks, copyrights, trade secrets, and other intellectual property. A listing of ON Semiconductor's product/patent coverage may be accessed at www.onsemi.com/site/pdf/Patent-Marking.pdf. ON Semiconductor reserves the right to make changes without further notice to any products herein. ON Semiconductor makes no warranty, representation or guarantee regarding the suitability of its products for any particular purpose, nor does ON Semiconductor assume any liability arising out of the application or use of any product or circuit, and specifically disclaims any and all liability, including without limitation special, consequential or incidental damages. Buyer is responsible for its products and applications using ON Semiconductor products, including compliance with all laws, regulations and safety requirements or standards, regardless of any support or applications information provided by ON Semiconductor. "Typical" parameters which may be provided in ON Semiconductor data sheets and/or specifications can and do vary in different applications and actual performance may vary over time. All operating parameters, including "Typicals" must be validated for each customer application by customer's technical experts. ON Semiconductor does not convey any license under its patent rights nor the rights of others. ON Semiconductor products are not designed, intended, or authorized for use as a critical component in life support systems or any FDA Class 3 medical devices or medical devices with a same or similar classification in a foreign jurisdiction or any devices intended for implantation in the human body. Should Buyer purchase or use ON Semiconductor products for any such unintended or unauthorized application, Buyer shall indemnify and hold ON Semiconductor and its officers, employees, subsidiaries, affiliates, and distributors harmless against all claims, costs, damages, and expenses, and reasonable attorney fees arising out of, directly or indirectly, any claim of personal injury or death associated with such unintended or unauthorized use, even if such claim alleges that ON Semiconductor was negligent regarding the design or manufacture of the part. ON Semiconductor is an Equal Opportunity/Affirmative Action Employer. This literature is subject to all applicable copyright laws and is not for resale in any manner.

PUBLICATION ORDERING INFORMATION

LITERATURE FULFILLMENT:

Literature Distribution Center for ON Semiconductor
19521 E. 32nd Pkwy, Aurora, Colorado 80011 USA
Phone: 303-675-2175 or 800-344-3860 Toll Free USA/Canada
Fax: 303-675-2176 or 800-344-3867 Toll Free USA/Canada
Email: orderlit@onsemi.com

N. American Technical Support: 800-282-9855 Toll Free
USA/Canada
Europe, Middle East and Africa Technical Support:
Phone: 421 33 790 2910
Japan Customer Focus Center
Phone: 81-3-5817-1050

ON Semiconductor Website: www.onsemi.com
Order Literature: <http://www.onsemi.com/orderlit>
For additional information, please contact your local
Sales Representative

X-ON Electronics

Largest Supplier of Electrical and Electronic Components

Click to view similar products for [MOSFET](#) category:

Click to view products by [ON Semiconductor](#) manufacturer:

Other Similar products are found below :

[614233C](#) [648584F](#) [MCH3443-TL-E](#) [MCH6422-TL-E](#) [FDPF9N50NZ](#) [FW216A-TL-2W](#) [FW231A-TL-E](#) [APT5010JVR](#) [NTNS3A92PZT5G](#)
[IRF100S201](#) [JANTX2N5237](#) [2SK2464-TL-E](#) [2SK3818-DL-E](#) [FCA20N60_F109](#) [FDZ595PZ](#) [STD6600NT4G](#) [FSS804-TL-E](#) [2SJ277-DL-E](#)
[2SK1691-DL-E](#) [2SK2545\(Q,T\)](#) [405094E](#) [423220D](#) [MCH6646-TL-E](#) [TPCC8103,L1Q\(CM](#) [367-8430-0972-503](#) [VN1206L](#) [424134F](#)
[026935X](#) [051075F](#) [SBVS138LT1G](#) [614234A](#) [715780A](#) [NTNS3166NZT5G](#) [751625C](#) [873612G](#) [IRF7380TRHR](#) [IPS70R2K0CEAKMA1](#)
[RJK60S3DPP-E0#T2](#) [RJK60S5DPK-M0#T0](#) [APT5010JVFR](#) [APT12031JFLL](#) [APT12040JVR](#) [DMN3404LQ-7](#) [NTE6400](#) [JANTX2N6796U](#)
[JANTX2N6784U](#) [JANTXV2N5416U4](#) [SQM110N05-06L-GE3](#) [SIHF35N60E-GE3](#) [2SK2614\(TE16L1,Q\)](#)