

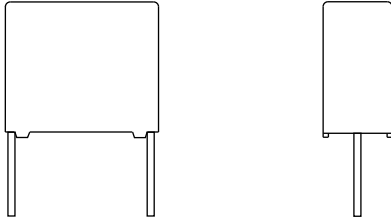

Interference Suppression Film Capacitors MKP Radial Potted Type



FEATURES

- 7.5 mm to 27.5 mm lead pitch
- Supplied loose in box, taped on reel
- Material categorization:
for definitions of compliance please see www.vishay.com/doc?99912



RoHS
COMPLIANT

APPLICATIONS

For standard across the line X2 applications

See also application note: www.vishay.com/doc?28153

QUICK REFERENCE DATA	
Capacitance range (E12 series)	0.001 μ F to 3.3 μ F (preferred values acc. to E6)
Capacitance tolerance	$\pm 20\%$; $\pm 10\%$, $\pm 5\%$
Climatic testing class according to IEC 60068-1	55/110/56/B
Rated AC voltage	310 V _{AC} ; 50 Hz to 60 Hz
Permissible DC voltage	800 V _{DC} at 85 °C, 630 V _{DC} at 110 °C
Maximum application temperature	C \leq 470 nF: 110 °C (125 °C for less than 1000 h), C > 470 nF: 110 °C
Reference standards	IEC 60384-14 ed-4 (2013) and EN 60384-14 IEC 60065 requires pass. flamm. class B UL 60384-14; CSA-E384-14, CQC
Dielectric	Polypropylene film
Electrodes	Metallized film
Construction	Mono construction 
Encapsulation	Plastic case, epoxy resin sealed, flame retardant UL-class 94 V-0
Leads	Tinned wire
Marking	C-value; tolerance; rated voltage; sub-class; manufacturer's type designation; code for dielectric material, manufacturer location; manufacturer's logo; year and week; safety approvals

Note

- For more detailed data and test requirements, contact: rfi@vishay.com

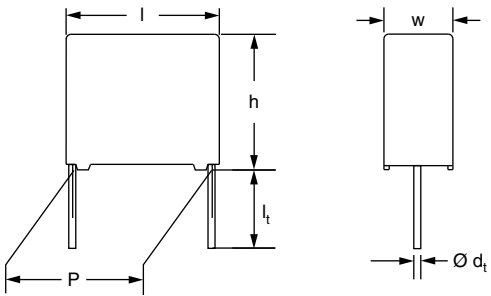
DIMENSIONS



COMPOSITION OF CATALOG NUMBER

TYPE AND PITCHES	
338 2 X2	7.5 mm
	10.0 mm
	15.0 mm
	22.5 mm
	27.5 mm

CAPACITANCE
(numerically)

MULTIPLIER (nF)	
0.1	2
1	3
10	4
100	5

Example:
104 = 10 x 10 = 100 nF

BFC2	338	2X	XX	X
2222(*)	338	2X	XX	X

(*) Old ordering code

TYPE	PACKAGING	STANDARD DIMENSIONS	C-TOL.	PREFERRED TYPES
MKP338 2 X2	Loose in box	Lead length 3.5 mm + 1 mm/- 0.5 mm; pitch ≤ 10.0 mm	± 20 %	BFC2 338 20
		Lead length 3.5 mm ± 0.3 mm; pitch ≥ 15.0 mm		BFC2 338 20
		Lead length 5.0 mm ± 1 mm		BFC2 338 22
		Lead length 25.0 mm ± 2 mm		BFC2 338 24
Taped ammo ⁽¹⁾	Taped reel ⁽¹⁾	Pitch ≤ 15.0 mm; H = 18.5 mm; P ₀ = 12.7 mm	± 20 % ± 10 % ± 5 %	See tables for details
		Pitch 22.5 mm; H = 18.5 mm; P ₀ = 12.7 mm		
TYPE	PACKAGING	ALTERNATIVE PITCH SIZES AND TOLERANCES	C-TOL.	PREFERRED TYPES
MKP338 2 X2	Loose in box	Packaging like 20 % and alternative pitch sizes	± 5 % ± 10 % ± 20 %	See tables for details

Notes

- ⁽¹⁾ Taped on reel and taped on ammo pitch = 27.5 mm is not available
- For detailed tape specifications refer to packaging information: www.vishay.com/doc?28139

SPECIFIC REFERENCE DATA		
DESCRIPTION	VALUE	
Rated AC voltage (U _{RAC})	310 V	
Permissible DC voltage (U _{RDC})	630 V	
Tangent of loss angle:	at 1 kHz	at 10 kHz
C ≤ 470 nF	≤ 10 x 10 ⁻⁴	≤ 20 x 10 ⁻⁴
470 nF < C ≤ 1 μF	≤ 20 x 10 ⁻⁴	≤ 70 x 10 ⁻⁴
C > 1 μF	≤ 30 x 10 ⁻⁴	-
Rated voltage pulse slope (dU/dt) _R at 435 V _{DC}		
Pitch = 7.5 mm	600 V/μs	
Pitch = 10 mm	600 V/μs	
Pitch = 15 mm and 7.5 mm (bent back)	400 V/μs	
Pitch = 22.5 mm	150 V/μs	
Pitch = 27.5 mm	100 V/μs	
R between leads, for C ≤ 0.33 μF at 100 V; 1 min	> 15 000 MΩ	
RC between leads, for C > 0.33 μF at 100 V; 1 min	> 5000 s	
R between leads and case; 100 V; 1 min	> 30 000 MΩ	
Withstanding (DC) voltage (cut off current 10 mA) ⁽¹⁾ ; rise time ≤ 1000 V/s:		
C ≤ 1 μF	2200 V; 1 min	
C > 1 μF	1800 V; 1 min	
Withstanding (AC) voltage between leads and case	2120 V; 1 min	
Max. application temperature for 0.001 μF ≤ C ≤ 0.47 μF	110 °C (125 °C for less than 1000 h)	
Max. application temperature for C > 0.47 μF	110 °C	

Note

- ⁽¹⁾ See "Voltage Proof Test for Metalized Film Capacitors": www.vishay.com/doc?28169



ELECTRICAL DATA AND ORDERING CODE - PITCH 7.5 mm										
U _{RAC} (V)	CAP. (μF)	DIMENSIONS w x h x l (mm)	MASS (g) ⁽²⁾	CATALOG NUMBER BFC2 338 AND PACKAGING						
				LOOSE IN BOX					AMMOPACK ⁽¹⁾	
				SHORT LEADS			LONG LEADS		H = 18.5 mm P ₀ = 12.7 mm	
				I _t = 3.5 mm + 1 mm/- 0.5 mm	I _t = 5.0 mm ± 1.0 mm	SPQ	I _t = 25.0 mm ± 2.0 mm	SPQ		SPQ
PITCH = 7.5 mm ± 0.4 mm; d _t = 0.50 mm ± 0.05 mm; C-TOL. = ± 20 %										
310	0.0010	4.0 x 9.0 x 10.0	0.4	20102	22102	1500	24102	1000	26102	1250
	0.0012			20122	22122		24122		26122	
	0.0015			20152	22152		24152		26152	
	0.0018			20182	22182		24182		26182	
	0.0022			20222	22222		24222		26222	
	0.0027			20272	22272		24272		26272	
	0.0033			20332	22332		24332		26332	
	0.0039			20392	22392		24392		26392	
	0.0047			20472	22472		24472		26472	
	0.0056			20562	22562		24562		26562	
	0.0068			20682	22682		24682		26682	
	0.0082			20822	22822		24822		26822	
	0.010			20103	22103		24103		26103	
	0.012			20123	22123		24123		26123	
	0.015			20153	22153		24153		26153	
	0.018			20183	22183		24183		26183	
	0.022	20223	22223	24223	26223					
	0.027	20273	22273	1000	24273	1250	26273	1000		
	0.033	20333	22333	750	24333	1000	26333	750		
	0.039	20393	22393	750	24393	1000	26393	750		
0.047	20473	22473	750	24473	1000	26473	750			
PITCH = 7.5 mm ± 0.4 mm; d _t = 0.50 mm ± 0.05 mm; C-TOL. = ± 10 %										
310	0.0010	4.0 x 9.0 x 10.0	0.4	28101	28301	1500	28501	1000	28701	1250
	0.0012			28102	28302		28502		28702	
	0.0015			28103	28303		28503		28703	
	0.0018			28104	28304		28504		28704	
	0.0022			28105	28305		28505		28705	
	0.0027			28106	28306		28506		28706	
	0.0033			28107	28307		28507		28707	
	0.0039			28108	28308		28508		28708	
	0.0047			28109	28309		28509		28709	
	0.0056			28111	28311		28511		28711	
	0.0068			28112	28312		28512		28712	
	0.0082			28113	28313		28513		28713	
	0.010			28114	28314		28514		28714	
	0.012			28115	28315		28515		28715	
	0.015			28116	28316		28516		28716	
	0.018			28117	28317		28517		28717	
	0.022	28118	28318	28518	28718					
	0.027	28119	28319	1000	28519	1250	28719	1000		
	0.033	28121	28321	750	28521	1000	28721	750		
	0.039	28122	28332	750	28522	1000	28722	750		
0.047	28123	28323	750	28523	1000	28723	750			



ELECTRICAL DATA AND ORDERING CODE - PITCH 7.5 mm										
U _{RAC} (V)	CAP. (μF)	DIMENSIONS w x h x l (mm)	MASS (g) ⁽²⁾	CATALOG NUMBER BFC2 338 AND PACKAGING						
				LOOSE IN BOX					AMMOPACK ⁽¹⁾	
				SHORT LEADS			LONG LEADS		H = 18.5 mm P ₀ = 12.7 mm	
				$l_t = 3.5 \text{ mm} + 1 \text{ mm} / - 0.5 \text{ mm}$	$l_t = 5.0 \text{ mm} \pm 1.0 \text{ mm}$	SPQ	$l_t = 25.0 \text{ mm} \pm 2.0 \text{ mm}$	SPQ		SPQ
PITCH = 7.5 mm ± 0.4 mm; d _t = 0.50 mm ± 0.05 mm; C-TOL. = ± 5 %										
310	0.0010	4.0 x 9.0 x 10.0	0.4	28201	28401	1500	28601	1000	28801	1250
	0.0012			28202	28402		28602		28802	
	0.0015			28203	28403		28603		28803	
	0.0018			28204	28404		28604		28804	
	0.0022			28205	28405		28605		28805	
	0.0027			28206	28406		28606		28806	
	0.0033			28207	28407		28607		28807	
	0.0039			28208	28408		28608		28808	
	0.0047			28209	28409		28609		28809	
	0.0056			28211	28411		28611		28811	
	0.0068			28212	28412		28612		28812	
	0.0082			28213	28413		28613		28813	
	0.010			28214	28414		28614		28814	
	0.012			28215	28415		28615		28815	
	0.015			28216	28416		28616		28816	
	0.018			28217	28417		28617		28817	
	0.022			28218	28418		28618		28818	
				0.027					28219	
	0.033	5.0 x 10.5 x 10.0	0.6	28221	28421	1000	28621	1250	28821	1000
	0.039			28222	28422	750	28622	1000	28822	750
	0.047	6.0 x 11.5 x 10.0	0.8	28223	28423	750	28623	1000	28823	750

Notes

• SPQ = Standard Packing Quantity

(1) H = In-tape height, P₀ = Sprocket hole distance; for detailed specifications refer to packaging information: www.vishay.com/doc?28139

(2) Weight for short lead product only

ELECTRICAL DATA AND ORDERING CODE - PITCH 10 mm										
U _{RAC} (V)	CAP. (μF)	DIMENSIONS w x h x l (mm)	MASS (g) ⁽²⁾	CATALOG NUMBER BFC2 338 AND PACKAGING						
				LOOSE IN BOX					AMMOPACK ⁽¹⁾	
				SHORT LEADS			LONG LEADS		H = 18.5 mm P ₀ = 12.7 mm	
				$l_t = 3.5 \text{ mm} + 1 \text{ mm} / - 0.5 \text{ mm}$	$l_t = 5.0 \text{ mm} \pm 1.0 \text{ mm}$	SPQ	$l_t = 25.0 \text{ mm} \pm 2.0 \text{ mm}$	SPQ		SPQ
PITCH = 10.0 mm ± 0.4 mm; d _t = 0.60 mm ± 0.06 mm; C-TOL. = ± 20 %										
310	0.0010	4.0 x 10.0 x 12.5	0.6	21102	23102	1000	25102	1250	Not available	
	0.0012			21122	23122		25122			
	0.0015			21152	23152		25152			
	0.0018			21182	23182		25182			
	0.0022			21222	23222		25222			
	0.0027			21272	23272		25272			
	0.0033			21332	23332		25332			
	0.0039			21392	23392		25392			
	0.0047			21472	23472		25472			
	0.0056			21562	23562		25562			



ELECTRICAL DATA AND ORDERING CODE - PITCH 10 mm																
U _{RAC} (V)	CAP. (µF)	DIMENSIONS w x h x l (mm)	MASS (g) ⁽²⁾	CATALOG NUMBER BFC2 338 AND PACKAGING												
				LOOSE IN BOX					AMMOPACK ⁽¹⁾							
				SHORT LEADS			LONG LEADS		H = 18.5 mm P ₀ = 12.7 mm							
				$l_t = 3.5 \text{ mm} + 1 \text{ mm} / - 0.5 \text{ mm}$	$l_t = 5.0 \text{ mm} \pm 1.0 \text{ mm}$	SPQ	$l_t = 25.0 \text{ mm} \pm 2.0 \text{ mm}$	SPQ		SPQ						
PITCH = 10.0 mm ± 0.4 mm; d_t = 0.60 mm ± 0.06 mm; C-TOL. = ± 20 %																
310	0.0068	4.0 x 10.0 x 12.5	0.6	21682	23682	1000	25682	1000	Not available							
	0.0082			21822	23822		25822									
	0.010			21103	23103		25103									
	0.012			21123	23123		25123									
	0.015			21153	23153		25153									
	0.018			21183	23183		25183									
	0.022			21223	23223		25223									
	0.027			21273	23273		25273									
	0.033			21333	23333		25333									
	0.039			21393	23393		25393									
	0.047			21473	23473		25473									
	0.056			5.0 x 11.0 x 12.5	0.82		20563				22563	750	24563	750	27563	500
	0.068						20683				22683		24683		27683	
	0.082	6.0 x 12.0 x 12.5	1.1	20823	22823	750	24823	750	27823	500						
	0.10			20104	22104		24104		27104							
	PITCH = 10.0 mm ± 0.4 mm; d_t = 0.60 mm ± 0.06 mm; C-TOL. = ± 10 %															
	310	0.0010	4.0 x 10.0 x 12.5	0.6	29194	29217	1000	29241	1250	Not available						
		0.0012			29195	29218		29242								
		0.0015			29196	29219		29243								
		0.0018			29197	29221		29244								
		0.0022			29198	29222		29245								
		0.0027			29199	29223		29246								
		0.0033			29201	29224		29247								
		0.0039			29202	29225		29248								
		0.0047			29203	29226		29249								
		0.0056			29204	29227		29251								
		0.0068			29205	29228		29252								
		0.0082			29206	29229		29253								
		0.010			29207	29231		29254								
		0.012			29208	29232		29255								
0.015		29209			29233	29256										
0.018		29211			29234	29257										
0.022		29212			29235	29258										
0.027		29213			29236	29259										
0.033		29214			29237	29261										
0.039		29215			29238	29262										
0.047		29216			29239	29263										
0.056		5.0 x 11.0 x 12.5			0.82	28124		28324	750			28524	750	28924	500	
0.068						28125		28325				28525		28925		
0.082		6.0 x 12.0 x 12.5			1.1	28126		28326	750			28526	750	28926		
PITCH = 10.0 mm ± 0.4 mm; d_t = 0.60 mm ± 0.06 mm; C-TOL. = ± 5 %																
0.056		5.0 x 11.0 x 12.5			0.82	28224		28424	750			28624	750	28944	500	
0.068		6.0 x 12.0 x 12.5			1.1	28225		28425	750			28625	750	28945	500	
0.082			28226	28426		28626	28946									

Notes

• SPQ = Standard Packing Quantity

⁽¹⁾ H = In-tape height, P₀ = Sprocket hole distance; for detailed specifications refer to packaging information: www.vishay.com/doc?28139

⁽²⁾ Weight for short lead product only



ELECTRICAL DATA AND ORDERING CODE - PITCH 15 mm													
U _{RAC} (V)	CAP. (μF)	DIMENSIONS w x h x l (mm)	MASS (g) ⁽²⁾	CATALOG NUMBER BFC2 338 AND PACKAGING									
				LOOSE IN BOX					AMMOPACK ⁽¹⁾				
				SHORT LEADS			LONG LEADS		H = 18.5 mm P ₀ = 12.7 mm				
				l _t = 3.5 mm ± 0.3 mm	l _t = 5.0 mm ± 1.0 mm	SPQ	l _t = 25.0 mm ± 2.0 mm	SPQ		SPQ			
PITCH = 15.0 mm ± 0.4 mm; d_t = 0.60 mm ± 0.06 mm; C-TOL. = ± 20 %													
0.010		5.0 x 11.0 x 17.5	1.0	29076	29096		29116		29141	1100			
0.012				29077	29097		29117		29143				
0.015				29078	29098		29118		29145				
0.018				29079	29099		29119		29147				
0.022				29081	29101		29121		29149				
0.027				29082	29102		29122		29152				
0.033				29083	29103	1000	29123	1000	29154				
0.039				29084	29104		29124		29156				
0.047				29085	29105		29125		29158				
0.056				21563	23563		25563		29161				
0.068				21683	23683		25683		29163				
0.082				21823	23823		25823		29165				
0.10				21104	23104		25104		29166				
0.12				20124	22124		24124		27124		900		
0.15	6.0 x 12.0 x 17.5	1.4	20154	22154	750		24154		500	27154	800		
0.18			20184	22184			24184			27184			
PITCH = 15.0 mm ± 0.4 mm; d_t = 0.80 mm ± 0.08 mm; C-TOL. = ± 20 %													
0.22	7.0 x 13.5 x 17.5	1.8	20224	22224	750		24224		500	27224	650		
0.27	8.5 x 15.0 x 17.5	2.4	20274	22274	750		24274		500	27274	650		
0.33			20334	22334	500		24334		450	27334	600		
PITCH = 15.0 mm ± 0.4 mm; d_t = 0.60 mm ± 0.06 mm; C-TOL. = ± 10 %													
0.010		5.0 x 11.0 x 17.5	1.0	29066	29086		29106		29139	1100			
0.012				29067	29087		29107		29142				
0.015				29068	29088		29108		29144				
0.018				29069	29089		29109		29146				
0.022				29071	29091		29111		29148				
0.027				29072	29092		29112		29151				
0.033				29073	29093	1000	29113	1000	29153				
0.039				29074	29094		29114		29155				
0.047				29075	29095		29115		29157				
0.056				29126	29131		29135		29159				
0.068				29127	29132		29136		29162				
0.082				29128	29133		29137		29164				
0.10				28127	28327		1000		28527		1000	28927	900
0.12	6.0 x 12.0 x 17.5			1.4	28128		28328		750		28528	500	28928
0.15		28129	28329				28529			28929			
PITCH = 15.0 mm ± 0.4 mm; d_t = 0.80 mm ± 0.08 mm; C-TOL. = ± 10 %													
0.18	7.0 x 13.5 x 17.5	1.8	28131	28331	750		28531		500	28931	650		
0.22			28132	28332			28532			28932			
0.27	8.5 x 15.0 x 17.5	2.4	28133	28333	500		28533		450	28933	600		
0.33			29129	29134			29138			29167			
PITCH = 15.0 mm ± 0.4 mm; d_t = 0.60 mm ± 0.06 mm; C-TOL. = ± 5 %													
0.10	5.0 x 11.0 x 17.5	1.0	28227	28427	1000	28627	1000	28947	900				
0.12	6.0 x 12.0 x 17.5	1.4	28228	28428	750	28628	500	28948	800				
0.15			28229	28429		28629		28949					
PITCH = 15.0 mm ± 0.4 mm; d_t = 0.80 mm ± 0.08 mm; C-TOL. = ± 5 %													
0.18	7.0 x 13.5 x 17.5	1.8	28231	28431	750	28631	500	28951	650				
0.22	8.5 x 15.0 x 17.5	2.4	28232	28432	750	28632	500	28952	650				
0.27			28233	28433	500	28633	450	28953	600				

Notes

• SPQ = Standard Packing Quantity

⁽¹⁾ H = In-tape height, P₀ = Sprocket hole distance; for detailed specifications refer to packaging information: www.vishay.com/doc?28139

⁽²⁾ Weight for short lead product only



ELECTRICAL DATA AND ORDERING CODE - PITCH 22.5 mm											
U _{RAC} (V)	CAP. (μF)	DIMENSIONS w x h x l (mm)	MASS (g) ⁽²⁾	CATALOG NUMBER BFC2 338 AND PACKAGING							
				LOOSE IN BOX					REEL (500 mm) ⁽¹⁾		
				SHORT LEADS			LONG LEADS		H = 18.5 mm P ₀ = 12.7 mm		
				l _t = 3.5 mm ± 0.3 mm	l _t = 5.0 mm ± 1.0 mm	SPQ	l _t = 25.0 mm ± 2.0 mm	SPQ		SPQ	
PITCH = 22.5 mm ± 0.4 mm; d_t = 0.80 mm ± 0.08 mm; C-TOL. = ± 20 %											
310	0.12	6.0 x 15.5 x 26.0	2.4	21124	23124	300	25124	250	29264	600	
	0.15			21154	23154		25154		29265		
	0.18			21184	23184		200		25184		29266
	0.22			21224	23224	25224		29267			
	0.27			21274	23274	25274		29268			
	0.33			21334	23334	25334	29269				
	0.39	7.0 x 16.5 x 26.0	2.9	20394	22394	200	24394	250	27394	450	
	0.47			20474	22474		24474		27474		
	0.56	8.5 x 18.0 x 26.0	3.8	20564	22564	200	24564	200	27564	350	
	0.68			20684	22684		24684		27684		
	0.82	10.0 x 19.5 x 26.0	6.8	20824	22824	150	24824	200	27824	300	
	1.0			20105	22105		24105		27105		
	PITCH = 22.5 mm ± 0.4 mm; d_t = 0.80 mm ± 0.08 mm; C-TOL. = ± 10 %										
	310	0.12	6.0 x 15.5 x 26.0	2.4	29169	29175	300	29181	250	29271	600
		0.15			29171	29176		29182		29272	
		0.18			29172	29177		200		29183	
		0.22			29173	29178	29184		29274		
		0.27			29174	29179	29185		29275		
0.33		28134			28334	28534	28934	450			
0.39		7.0 x 16.5 x 26.0	2.9	28135	28335	200	28535	250	28935	450	
0.47				28136	28336		28536		28936		
0.56		8.5 x 18.0 x 26.0	3.8	28137	28337	200	28537	200	28937	350	
0.68				28138	28338		28538		28938		
0.82		10.0 x 19.5 x 26.0	6.8	28139	28339	150	28539	200	28939	300	
PITCH = 22.5 mm ± 0.4 mm; d_t = 0.80 mm ± 0.08 mm; C-TOL. = ± 5 %											
310	0.33	7.0 x 16.5 x 26.0	2.9	28234	28434	200	28634	250	28954	450	
	0.39			28235	28435		28635		28955		
	0.47	8.5 x 18.0 x 26.0	3.8	28236	28436	200	28636	200	28956	350	
	0.56			28237	28437		28637		28957		
	0.68	10.0 x 19.5 x 26.0	6.8	28238	28438	150	28638	200	28958	300	
	0.82	12.0 x 22.0 x 26.0	7.8	28239	28439	150	28639	200	28959	300	

Notes

• SPQ = Standard Packing Quantity

(1) H = In-tape height, P₀ = Sprocket hole distance; for detailed specifications refer to packaging information: www.vishay.com/doc?28139



(2) Weight for short lead product only



ELECTRICAL DATA AND ORDERING CODE - PITCH 27.5 mm									
U _{RAC} (V)	CAP. (μF)	DIMENSIONS w x h x l (mm)	MASS (g) ⁽¹⁾	CATALOG NUMBER BFC2 338 AND PACKAGING					
				LOOSE IN BOX					
				SHORT LEADS			LONG LEADS		
				l _t = 3.5 mm ± 0.3 mm	l _t = 5.0 mm ± 1.0 mm	SPQ	l _t = 25.0 mm ± 2.0 mm	SPQ	
PITCH = 27.5 mm ± 0.4 mm; d_t = 0.80 mm ± 0.08 mm; C-TOL. = ± 20 %									
310	0.39	9.0 x 19.0 x 31.5	5.5	21394	23394	100	25394	150	
	0.47			21474	23474		25474		
	0.56			21564	23564		25564		
	0.68			21684	23684		25684		
	0.82			21824	23824		25824		
	1.0	11.0 x 21.0 x 31.0	7.4	21105	23105	100	25105	125	
	1.2			20125	22125		24125		
	1.5	13.0 x 23.0 x 31.0	9.2	20155	22155	100	24155	100	
	1.8			20185	22185		24185		
	2.2	15.0 x 25.0 x 31.5	12.3	20225	22225	50	24225	75	
	2.7	18.0 x 28.0 x 31.5	16.1	20275	22275		24275		
	3.3			20335	22335	24335			
	PITCH = 27.5 mm ± 0.4 mm; d_t = 0.80 mm ± 0.08 mm; C-TOL. = ± 10 %								
	310	1.0	11.0 x 21.0 x 31.0	7.4	28141	28341	100	28541	125
		1.2			28142	28342		28542	
		1.5	13.0 x 23.0 x 31.0	9.2	28143	28343		28543	
		1.8	15.0 x 25.0 x 31.5	12.3	28144	28344	50	28544	100
		2.2			28145	28345		28545	
2.7		18.0 x 28.0 x 31.5	16.1	28146	28346	50	28546	75	
PITCH = 27.5 mm ± 0.4 mm; d_t = 0.80 mm ± 0.08 mm; C-TOL. = ± 5 %									
310		1.0	11.0 x 21.0 x 31.0	7.4	28241	28441	100	28641	125
		1.2	13.0 x 23.0 x 31.0	9.2	28242	28442	100	28642	125
		1.5			28243	28443		28643	
	1.8	15.0 x 25.0 x 31.5	12.3	28244	28444	100	28644	100	
	2.2	18.0 x 28.0 x 31.5	16.1	28245	28445	50	28645	75	
	2.7			28246	28446		28646		

Notes

- SPQ = Standard Packing Quantity
- ⁽¹⁾ Weight for short lead product only

APPROVALS				
SAFETY APPROVALS X2	VOLTAGE	VALUE	FILE NUMBERS	LINKS
EN60384-14 (ENEC) (= IEC 60384-14 ed-4 (2013))	310 V _{AC}	1 nF to 3.3 μF	FI 2016052	www.vishay.com/doc?28179
UL 60384-14	310 V _{AC}	1 nF to 3.3 μF	E354331	www.vishay.com/doc?28184
CSA-E384-14	310 V _{AC}	1 nF to 3.3 μF	E354331	
CQC	310 V _{AC}	1 nF to 3.3 μF	CQC07001018685 (F)	www.vishay.com/doc?28227
			CQC07001021279 (L)	www.vishay.com/doc?28228
CB-test certificate	310 V _{AC}	1 nF to 3.3 μF	FI 9369	www.vishay.com/doc?28175
The ENEC-approval together with the CB-certificate replace all national marks of the following countries (they have already signed the ENEC-agreement): Austria; Belgium; Czech. Republic; Denmark; Finland; France; Germany; Greece; Hungary; Ireland; Italy; Luxembourg; Netherlands; Norway; Portugal; Slovenian; Spain; Sweden; Switzerland; and United Kingdom.				
  				

MOUNTING

Normal Use

The capacitors are designed for mounting on printed-circuit boards. The capacitors packed in bandoliers are designed for mounting in printed-circuit boards by means of automatic insertion machines.

For detailed tape specifications refer to packaging information: www.vishay.com/doc?28139

Specific Method of Mounting to Withstand Vibration and Shock

In order to withstand vibration and shock tests, it must be ensured that the stand-off pips are in good contact with the printed-circuit board:

- For pitches ≤ 15 mm capacitors shall be mechanically fixed by the leads
- For longer pitches the capacitors shall be mounted in the same way and the body clamped

Space Requirements on Printed Circuit Board

The maximum space for length ($l_{max.}$), width ($w_{max.}$) and height ($h_{max.}$) of film capacitors to take in account on the printed circuit board is shown in the drawings.

- For products with pitch ≤ 15 mm, $\Delta w = \Delta l = 0.3$ mm; $\Delta h = 0.1$ mm
- For products with 15 mm $<$ pitch ≤ 27.5 mm, $\Delta w = \Delta l = 0.5$ mm; $\Delta h = 0.1$ mm

Eccentricity defined as in drawing. The maximum eccentricity is smaller than or equal to the lead diameter of the product concerned.

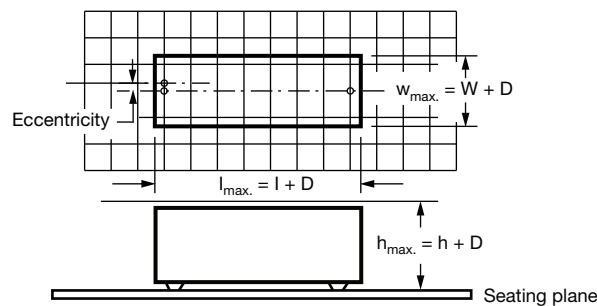

SOLDERING

For general soldering conditions and wave soldering profile, we refer to the application note: "Soldering Guidelines for Film Capacitors": www.vishay.com/doc?28171

Storage Temperature

$T_{stg} = -25$ °C to $+35$ °C with RH maximum 75 % without condensation

Ratings and Characteristics Reference Conditions

Unless otherwise specified, all electrical values apply to an ambient temperature of 23 °C ± 1 °C, an atmospheric pressure of 86 kPa to 106 kPa and a relative humidity of 50 % ± 2 %.

For reference testing, a conditioning period shall be applied over 96 h ± 4 h by heating the products in a circulating air oven at the rated temperature and a relative humidity not exceeding 20 %.

CHARACTERISTICS

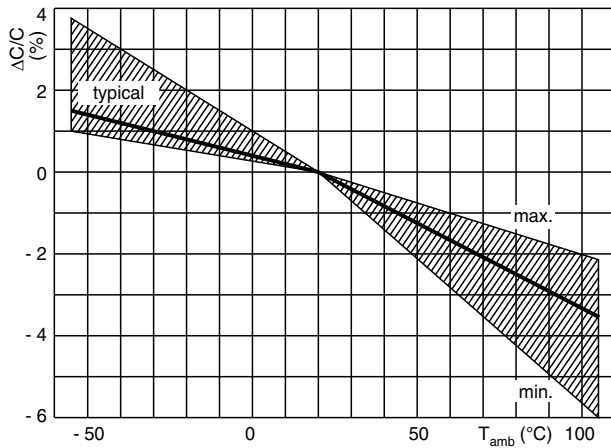

Capacitance as a function of ambient temperature (typical curve)

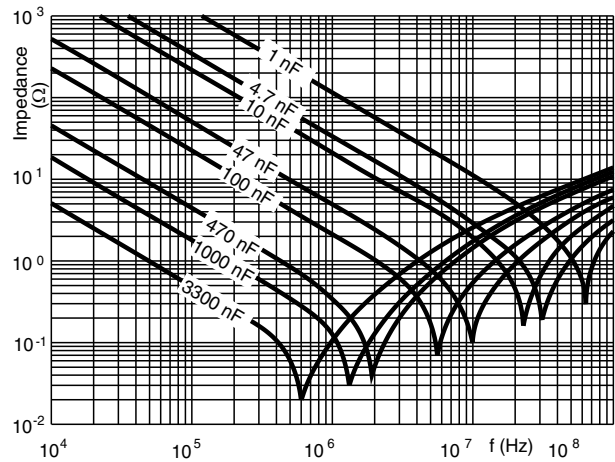

Impedance as a function of frequency (typical curve)

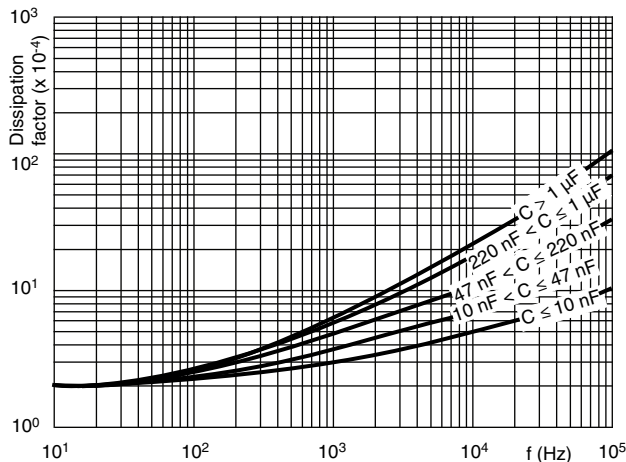

Tangent of loss angle as a function of frequency (typical curve)

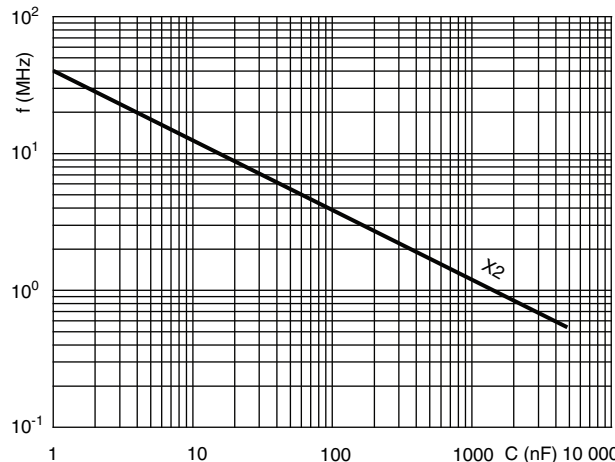

Resonant frequency as a function of capacitance (typical curve)

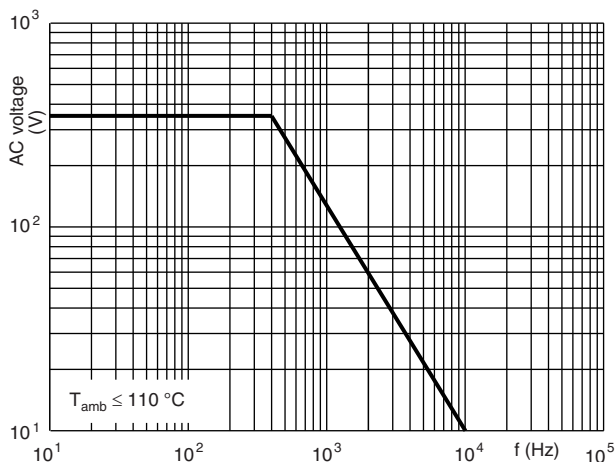

Max. RMS voltage as a function of frequency (typical curve)

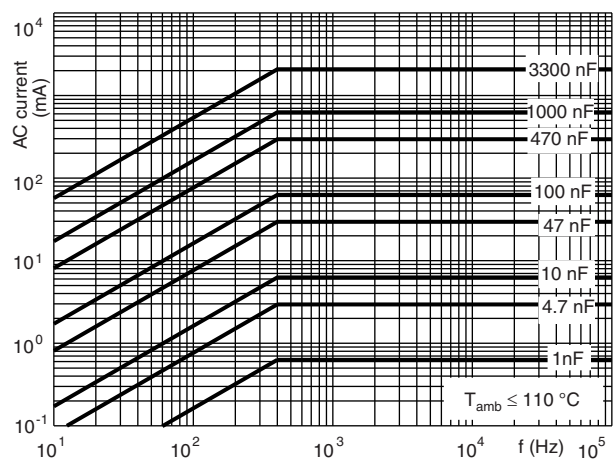

Max. RMS current as a function of frequency (typical curve)

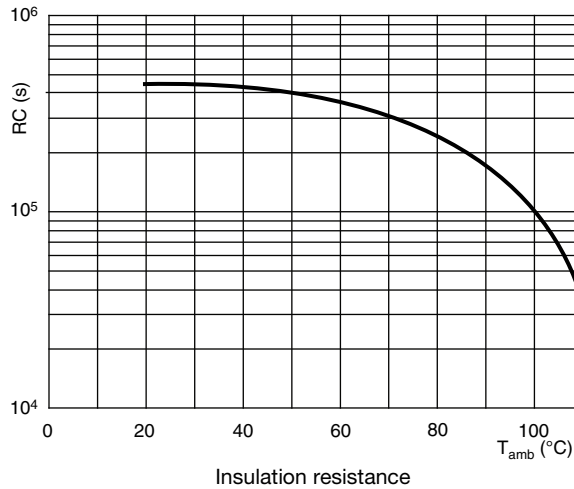

APPLICATION NOTES

- For X2 electromagnetics interference suppression in **standard across the line applications** (50 Hz/60 Hz) with a maximum mains voltage of 310 V_{AC}.
- For series impedance applications we refer to application note www.vishay.com/doc?28153
- For capacitors connected in parallel, normally the proof voltage and possibly the rated voltage must be reduced. For information depending of the capacitance value and the number of parallel connections contact: rfi@vishay.com
- These capacitors are not intended for continuous pulse applications. For these situations, capacitors of the AC and pulse programs must be used.
- The maximum ambient temperature must not exceed 105 °C (125 °C for less than 1000 h) for C ≤ 470 nF and 110 °C for C > 470 nF
- Rated voltage pulse slope:
If the pulse voltage is lower than the rated voltage, the values of the specific reference data can be multiplied by 435 V_{DC} and divided by the applied voltage.

INSPECTION REQUIREMENTS

General Notes

Sub-clause numbers of tests and performance requirements refer to the “Sectional Specification, IEC Publication IEC 60384-14 ed-4 (2013) and Specific Reference Data.”

GROUP C INSPECTION REQUIREMENTS		
SUB-CLAUSE NUMBER AND TEST	CONDITIONS	PERFORMANCE REQUIREMENTS
SUB-GROUP C1A PART OF SAMPLE OF SUB-GROUP C1		
4.1 Dimensions (detail)		As specified in chapters “General Data” of this specification
Initial measurements	Capacitance Tangent of loss angle: For C ≤ 1 µF at 10 kHz For C > 1 µF at 1 kHz	
4.3 Robustness of terminations	Tensile: Load 10 N; 10 s Bending: Load 5 N; 4 x 90°	No visible damage
4.4 Resistance to soldering heat	No pre-drying Method: 1A Solder bath: 280 °C ± 5 °C Duration: 10 s	



GROUP C INSPECTION REQUIREMENTS		
SUB-CLAUSE NUMBER AND TEST	CONDITIONS	PERFORMANCE REQUIREMENTS
SUB-GROUP C1A PART OF SAMPLE OF SUB-GROUP C1		
4.19 Component solvent resistance	Isopropylalcohol at room temperature Method: 2 Immersion time: 5 min ± 0.5 min Recovery time: Min. 1 h, max. 2 h	
4.4.2 Final measurements	Visual examination Capacitance Tangent of loss angle Insulation resistance	No visible damage Legible marking $ \Delta C/C \leq 5\%$ of the value measured initially Increase of $\tan \delta$: ≤ 0.008 for: $C \leq 1 \mu F$ or ≤ 0.005 for: $C > 1 \mu F$ Compared to values measured initially As specified in section "Insulation resistance" of this specification
SUB-GROUP C1B PART OF SAMPLE OF SUB-GROUP C1		
Initial measurements	Capacitance Tangent of loss angle: For $C \leq 1 \mu F$ at 10 kHz For $C > 1 \mu F$ at 1 kHz	
4.20 Solvent resistance of the marking	Isopropylalcohol at room temperature Method: 1 Rubbing material: Cotton wool Immersion time: 5 min ± 0.5 min	No visible damage Legible marking
4.6 Rapid change of temperature	$\theta A = -55\text{ }^\circ C$ $\theta B = +110\text{ }^\circ C$ 5 cycles Duration $t = 30$ min	
4.6.1 Inspection	Visual examination	No visible damage
4.7 Vibration (see note 3.1)	Mounting: See section "Mounting" of this specification Procedure B4 Frequency range: 10 Hz to 55 Hz. Amplitude: 0.75 mm or Acceleration 98 m/s ² (whichever is less severe) Total duration 6 h	
4.7.2 Final inspection	Visual examination	No visible damage
4.9 Shock (see note 3)	Mounting: See section "Mounting" for more information Pulse shape: Half sine Acceleration: 490 m/s ² Duration of pulse: 11 ms	
4.9.2 Final measurements	Visual examination Capacitance Tangent of loss angle Insulation resistance	No visible damage $ \Delta C/C \leq 5\%$ of the value measured initially Increase of $\tan \delta$: ≤ 0.008 for: $C \leq 1 \mu F$ or ≤ 0.005 for: $C > 1 \mu F$ Compared to values measured initially As specified in section "Insulation resistance" of this specification



GROUP C INSPECTION REQUIREMENTS		
SUB-CLAUSE NUMBER AND TEST	CONDITIONS	PERFORMANCE REQUIREMENTS
SUB-GROUP C1 COMBINED SAMPLE OF SPECIMENS OF SUB-GROUPS C1A AND C1B		
4.11 Climatic sequence		
4.11.1 Initial measurements	Capacitance Measured in 4.4.2 and 4.9.2 Tangent of loss angle: Measured initially in C1A and C1B	
4.11.2 Dry heat	Temperature: 110 °C	
4.11.3 Damp heat cyclic Test Db First cycle	Duration: 16 h	
4.11.4 Cold	Temperature: - 55 °C	
4.11.5 Damp heat cyclic Test Db Remaining cycles	Duration: 2 h	
4.11.6 Final measurements	Visual examination	No visible damage Legible marking
	Capacitance	$ \Delta C/C \leq 5\%$ of the value measured in 4.11.1.
	Tangent of loss angle	Increase of $\tan \delta$: ≤ 0.008 for: $C \leq 1 \mu\text{F}$ or ≤ 0.005 for: $C > 1 \mu\text{F}$ Compared to values measured in 4.11.1.
	Voltage proof 1350 V _{DC} ; 1 min between terminations	No permanent breakdown or flash-over
	Insulation resistance	$\geq 50\%$ of values specified in section "Insulation resistance" of this specification
SUB GROUP C2		
4.12 Damp heat steady state	56 days; 40 °C; 90 % to 95 % RH no load	
4.12.1 Initial measurements	Capacitance Tangent of loss angle: at 1 kHz	
4.12.3 Final measurements	Visual examination	No visible damage Legible marking
	Capacitance	$ \Delta C/C \leq 5\%$ of the value measured in 4.12.1.
	Tangent of loss angle	Increase of $\tan \delta$: ≤ 0.008 for: $C \leq 1 \mu\text{F}$ or ≤ 0.005 for: $C > 1 \mu\text{F}$ Compared to values measured in 4.12.1.
	Voltage proof 1350 V _{DC} ; 1 min between term.	No permanent breakdown or flash-over
	Insulation resistance	$\geq 50\%$ of values specified in section "Insulation Resistance" of this specification

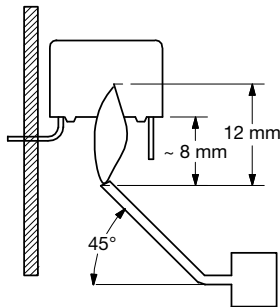

GROUP C INSPECTION REQUIREMENTS		
SUB-CLAUSE NUMBER AND TEST	CONDITIONS	PERFORMANCE REQUIREMENTS
SUB-GROUP C3		
4.13.1 Initial measurements	Capacitance Tangent of loss angle: For C ≤ 1 μF at 10 kHz For C > 1 μF at 1 kHz	
4.13 Impulse voltage	3 successive impulses, full wave, peak voltage: X2: 2.5 kV for C ≤ 1 μF X2: 2.5 kV/√C for C > 1 μF Max. 24 pulses	No selfhealing breakdowns or flashover
4.14 Endurance	Duration: 1000 h 1.25 x U _{RAC} at 110 °C Once in every hour the voltage is increased to 1000 V _{RMS} for 0.1 s via resistor of 47 Ω ± 5 %	
4.14.7 Final measurements	Visual examination Capacitance Tangent of loss angle Voltage proof 1350 V _{DC} ; 1 min between terminations. 2120 V _{AC} ; 1 min between terminations and case Insulation resistance	No visible damage Legible marking ΔC/C ≤ 10 % compared to values measured in 4.13.1. Increase of tan δ: ≤ 0.008 for: C ≤ 1 μF or ≤ 0.005 for: C > 1 μF Compared to values measured in 4.13.1. No permanent breakdown or flash-over ≥ 50 % of values specified in section "Insulation resistance" of this specification
SUB-GROUP C4		
4.15 Charge and discharge	10 000 cycles Charge to 435 V _{DC} Discharge resistance: $R = \frac{435 V_{DC}}{1.25 \times C (dU/dt)}$	
4.15.1 Initial measurements	Capacitance Tangent of loss angle: For C ≤ 1 μF at 10 kHz For C > 1 μF at 1 kHz	
4.15.3 Final measurements	Capacitance Tangent of loss angle Insulation resistance	ΔC/C ≤ 10 % compared to values measured in 4.15.1. Increase of tan δ: ≤ 0.008 for: C ≤ 1 μF or ≤ 0.005 for: C > 1 μF Compared to values measured in 4.15.1. ≥ 50 % of values specified in section "Insulation Resistance" of this specification

GROUP C INSPECTION REQUIREMENTS		
SUB-CLAUSE NUMBER AND TEST	CONDITIONS	PERFORMANCE REQUIREMENTS
SUB-GROUP C5		
4.16 Radio frequency characteristic	Resonance frequency	≥ 0.9 times the value as specified in section "Resonant frequency" of this specification
SUB-GROUP C6		
4.17 Passive flammability Class B	Bore of gas jet: $\varnothing 0.5$ mm Fuel: Butane Test duration for actual volume V in mm^3 : $V \leq 250$: 10 s $250 < V \leq 500$: 20 s $500 < V \leq 1750$: 30 s $V > 1750$: 60 s One flame application 	After removing test flame from capacitor, the capacitor must not continue to burn for more than 10 s. No burning particle must drop from the sample.
SUB-GROUP C7		
4.18 Active flammability	20 cycles of 2.5 kV discharges on the test capacitor connected to U_{RAC}	The cheese cloth around the capacitors shall not burn with a flame. No electrical measurements are required.



Disclaimer

ALL PRODUCT, PRODUCT SPECIFICATIONS AND DATA ARE SUBJECT TO CHANGE WITHOUT NOTICE TO IMPROVE RELIABILITY, FUNCTION OR DESIGN OR OTHERWISE.

Vishay Intertechnology, Inc., its affiliates, agents, and employees, and all persons acting on its or their behalf (collectively, "Vishay"), disclaim any and all liability for any errors, inaccuracies or incompleteness contained in any datasheet or in any other disclosure relating to any product.

Vishay makes no warranty, representation or guarantee regarding the suitability of the products for any particular purpose or the continuing production of any product. To the maximum extent permitted by applicable law, Vishay disclaims (i) any and all liability arising out of the application or use of any product, (ii) any and all liability, including without limitation special, consequential or incidental damages, and (iii) any and all implied warranties, including warranties of fitness for particular purpose, non-infringement and merchantability.

Statements regarding the suitability of products for certain types of applications are based on Vishay's knowledge of typical requirements that are often placed on Vishay products in generic applications. Such statements are not binding statements about the suitability of products for a particular application. It is the customer's responsibility to validate that a particular product with the properties described in the product specification is suitable for use in a particular application. Parameters provided in datasheets and / or specifications may vary in different applications and performance may vary over time. All operating parameters, including typical parameters, must be validated for each customer application by the customer's technical experts. Product specifications do not expand or otherwise modify Vishay's terms and conditions of purchase, including but not limited to the warranty expressed therein.

Except as expressly indicated in writing, Vishay products are not designed for use in medical, life-saving, or life-sustaining applications or for any other application in which the failure of the Vishay product could result in personal injury or death. Customers using or selling Vishay products not expressly indicated for use in such applications do so at their own risk. Please contact authorized Vishay personnel to obtain written terms and conditions regarding products designed for such applications.

No license, express or implied, by estoppel or otherwise, to any intellectual property rights is granted by this document or by any conduct of Vishay. Product names and markings noted herein may be trademarks of their respective owners.

X-ON Electronics

Largest Supplier of Electrical and Electronic Components

Click to view similar products for [Safety Capacitors](#) category:

Click to view products by [Vishay](#) manufacturer:

Other Similar products are found below :

[46KI3470DQM1K](#) [46KR410000M1M](#) [46KI333050M1K](#) [46KN333000M1M](#) [46KN347000M1M](#) [46KR422000M1K](#)
[DE1E3KX472MJ4BN01F](#) [ECQ-U2A224MLC](#) [04068](#) [46KF268000M1M](#) [46KI3150NDM2M](#) [MKPX2R-1/400/10P27](#)
[YP102271K050B20C6P](#) [YP102391K050BAND5P](#) [YP501101K040BAND5P](#) [YP102681K060B20C6P](#) [YP501121K040B20C6P](#)
[YP501471K040B20C6P](#) [YP501102K050HAND5P](#) [YP500101K040B20C2P](#) [GX4097C](#) [GX4201C](#) [46KN322000M1M](#)
[MKX21W14702C00MSSD](#) [MKY22W12203D00KSSD](#) [46KN347000N0M](#) [MPX21W1330FA00MSSD](#) [MPX21W3330FJ00MSSD](#)
[MPY20W1150FA00MSSD](#) [MPY20W1220FA00MSSD](#) [MKY22W11003D00KSSD](#) [MPX21W2100FC00MSSD](#) [MPX21W3220FI00MSSD](#)
[P272QE103M300A](#) [46KR415000M1K](#) [46KI333000H2M](#) [46KI2220CK01K](#) [C971U472MUWDCA7317](#) [46KI310050M1M](#) [46KI347000M1M](#)
[46KN4100JPN2M](#) [46KW510000M1M](#) [R49AI24705001K](#) [R49AN31005001K](#) [R46KI3470CKN0M](#) [BFC233915104](#)
[DE1E3RA102MA4BQ01F](#) [DE6E3KJ332MB3B](#) [MPX21W1100FA00MSSD](#) [VY2103M59Y5VS63V0](#)