

1400  
1450  
1480  
1500

igus.de

1400 

1450 · 1480 

1500 

 Price index

 IPA Qualification Certificate Air  
Cleanless Class ISO Class 3  
(at v = 2 m/s) upon request

 ESD classification:  
Electrically conductive ESD/ATEX  
version upon request

 UL94 V2 classifications  
upon request



New snap-open mechanism, choice of snap-open on left or right. Hinged crossbar can be swiveled by more than 180° on both sides. Lightning-fast closing with the touch of a thumb. – Secure fit without additional locking devices.



When to use the Series 1400/1450/1480/1500:

- If snap-open accessibility along inner or outer radius is required
- If integrated strain relief is required at the connection point
- If "Half" E-Tube is required (Series 1450)
- If fully enclosed E-Tube is required (Series 1480)
- If long service life is required
- If easy installation is required
- Standard product with many accessories



When not to use it:

- If the application is very simple
  - ▶ Easy Chain®, Series E14, chapter 3

- ❶ Opening system for rapid opening, either from the right or the left
- ❷ Double stop dog for strong unsupported length
- ❸ Cross bars with high locking range
- ❹ Series 1400 snap-open on both sides along inner radius
- ❺ Series 1500 snap-open on both sides along outer radius
- ❻ Series 1450 "Half" E-Tube snap-open on both sides along inner radius
- ❼ Series 1480 fully enclosed E-Tube snap-open on both sides along inner radius
- ❽ Tried-and-tested firmly-locked mounting bracket
- ❾ Modular interior separation
- ❿ Easy assembly by optimized pin
- ⓫ Integrated strain relief possible
- ⓬ Also available as ESD version

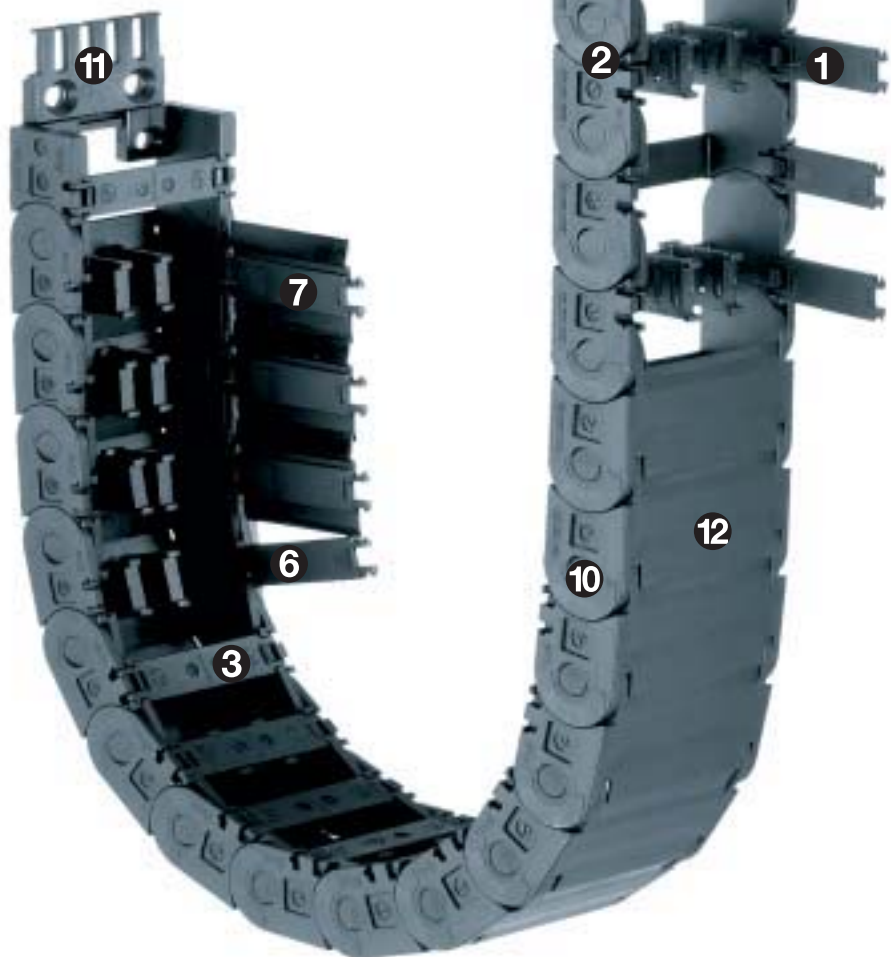

Order example complete E-Chain®

Please indicate chain-lengths or number of links Example: 3 m or 90 links

3 m 1400.038.100.0

 E-Chain®

with 2 separators 14011 assembled every 2<sup>nd</sup> link

 Interior separation

1 set 15000.038.34PZB

 Mounting bracket

# Installation Dimensions and Technical Data

## Unsupported length

$FL_G$  = with straight upper run

$FL_B$  = with permitted sag

Further information ► **Design, chapter 1**

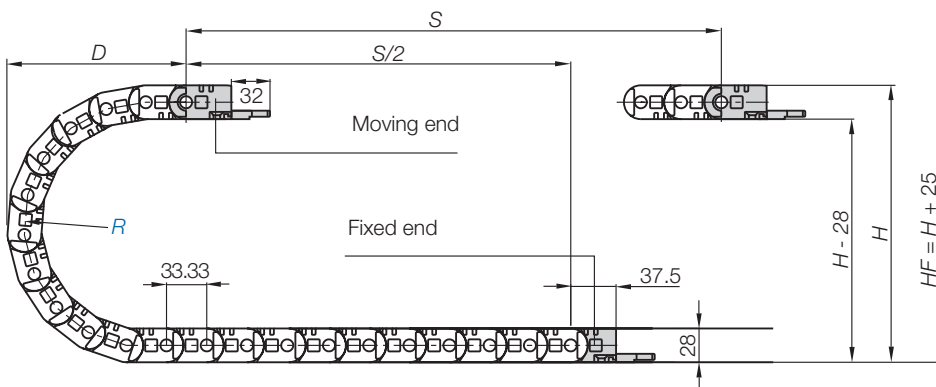
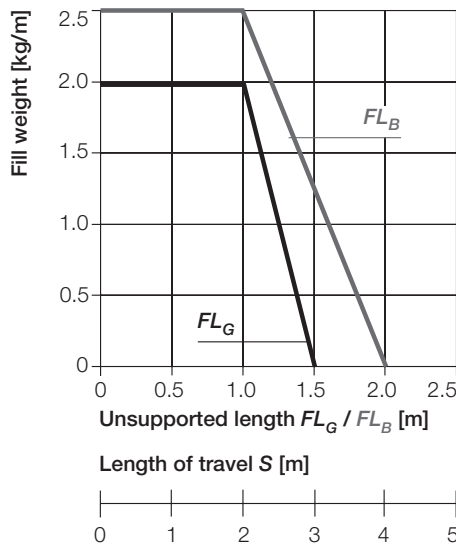
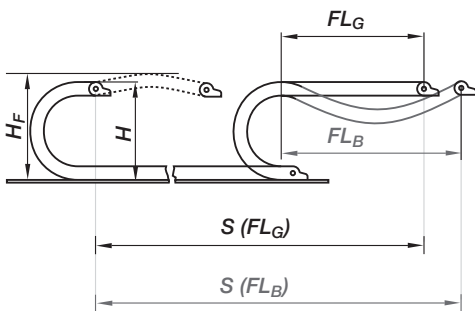

Pitch = 33,3 mm/link    Links/m = 30 (1000 mm)    Chain length =  $S/2 + K$

R	035*	038*	048*	075	100	125	145	180
H	98	104	124	178	228	278	318	388
D	85	90	100	125	150	175	195	230
K	180	190	220	305	385	460	525	635
$D_2^{+25}$	-	-	-	-	340	495	**	**
$K_2$	-	-	-	-	600	800	**	**

\*not available for Series 1480, for Series 1450 available upon request/ \*\*upon request

Long travel lengths from 10 m to max. 75 m    Chain length =  $S/2 + K_2$

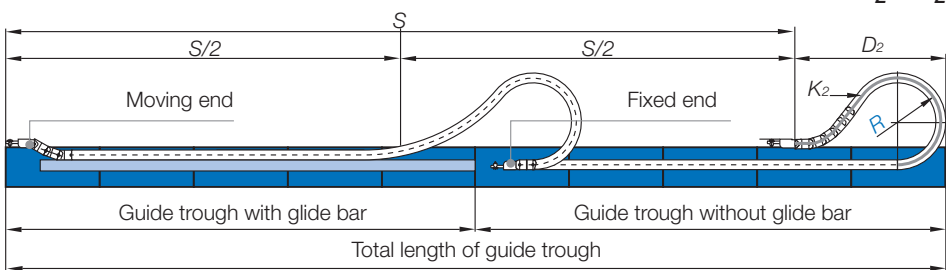

In case of travels between 4 and 10 m we recommend a longer unsupported length.

Speed / acceleration $FL_G$	max. 20 [m/s] / max. 200 [m/s <sup>2</sup> ]
Speed / acceleration $FL_B$	max. 3 [m/s] / max. 6 [m/s <sup>2</sup> ]
Gliding speed / acceleration (maximum)	max. 10 [m/s] / max. 50 [m/s <sup>2</sup> ]
Material - permitted temperature °C	igumid G / -40° up to +130° C
Flammability class, igumid G	VDE 0304 IIC UL94 HB

- $S$  = Length of travel
- $R$  = Bending radius
- $H$  = Nominal clearance height
- $H_F$  = Required clearance height
- $H_{Ri}$  = Trough inner height
- $D$  = Overlength E-Chain® radius in final position
- $K = \pi \cdot R + \text{"safety"}$
- $D_2$  = Over length for long travels gliding
- $K_2$  = Further add-on if the mounting bracket location is set lower

### Other installation methods

- Vertical, hanging ≤ 20 m
- Vertical, standing ≤ 2 m
- Side mounted, unspupp. ≤ 0,7 m
- Rotary requires further calculation

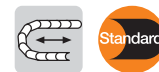

### Short travels - unsupported

Unsupported E-Chains® feature positive camber over short travels. This must be accounted for when specifying the clearance height  $H_F$ . Please consult igus® if space is particularly restricted.

The required clearance height:

$$H_F = H + 25 \text{ mm}$$

(with 0,5 kg/m fill weight)



### Gliding, long travel applications (max. 75 m)

In this case the E-Chain® upper run will be introduced in a guide trough on the lower run. We recommend to realize the engineering of such a plant by our technicians.

### Technical Data



Details of material properties

► **chapter 1**



E2 / 000 medium  
Inner height: 21 mm

Phone +49- (0) 22 03-96 49-800  
Fax +49- (0) 22 03-96 49-222



on request



► page 5.73

# Series 1450 · 1480 - E-Tubes Product Range

## Series 1450 - "Half" E-Tube - snap-open along inner radius

Part No.	<i>Bi</i> [mm]	<i>Ba</i> [mm]	<i>R</i> [mm]	Bending radii	Weight [kg/m]
1450.015.□.0	15	28,5	035*	038* 048* 075 100 125 145 180	≈ 0,48
1450.025.□.0	25	38,5	035*	038* 048* 075 100 125 145 180	≈ 0,54
1450.038.□.0	38	51,5	035*	038* 048* 075 100 125 145 180	≈ 0,60
1450.050.□.0	50	63,5	035*	038* 048* 075 100 125 145 180	≈ 0,65
1450.068.□.0	68	81,5	035*	038* 048* 075 100 125 145 180	≈ 0,74
1450.080.□.0	80	93,5	035*	038* 048* 075 100 125 145 180	≈ 0,78
1450.100.□.0	100	113,5	035*	038* 048* 075 100 125 145 180	≈ 0,88
1450.125.□.0	125	138,5	035*	038* 048* 075 100 125 145 180	≈ 0,99

\*upon request

Supplement Part No. with required radius. Example: 1450.015.075.0

0 = standard color, other colors ► chapter 1 · Pitch = 33,3 mm/link - Links/m = 30

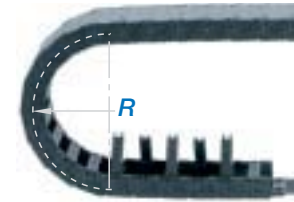
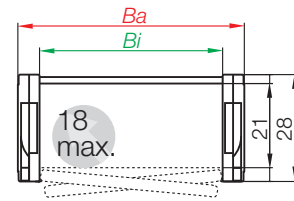

Part No. structure

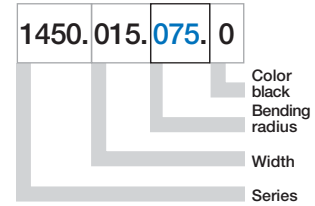

E2 /000 medium  
Inner height: 21 mm

Phone +49- (0) 22 03-96 49-800  
Fax +49- (0) 22 03-96 49-222

## Series 1480 - E-Tube - snap-open along inner radius

Part No.	<i>Bi</i> [mm]	<i>Ba</i> [mm]	<i>R</i> [mm]	Bending radii	Weight [kg/m]
1480.038.□.0	38	51,5	075	100 125 145 180	≈ 0,62
1480.050.□.0	50	63,5	075	100 125 145 180	≈ 0,76

More widths in preparation!

Supplement Part No. with required radius. Example: 1480.038.075.0

0 = standard color, other colors ► chapter 1 · Pitch = 33,3 mm/link - Links/m = 30

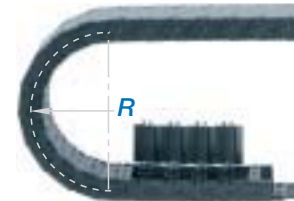
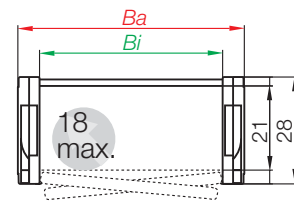

Part No. structure

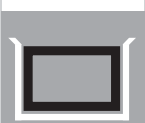
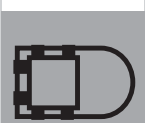
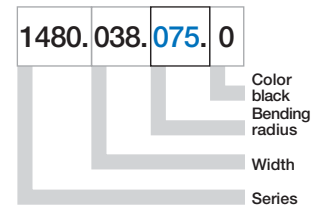

on request



► page 5.73

Vert. Separator, slotted	
unassembled	14001
assembled	14011

**Option 1: Vertical Separators for E-Chains® Series 1400 · 1500**

- Vertical Separators are used if a vertical subdivision of the E-Chain® interior is required.
- Standard subdivision with Vertical Separator, slotted 14011, for combinations with Full-Width Shelf 111.X
- Standard: Vertical Separators are assembled every other chain link.

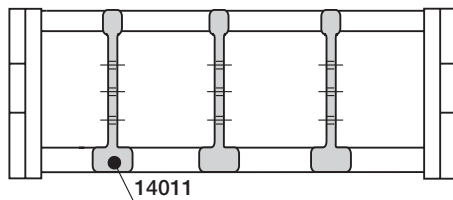

Vert. Separator, slotted	
unassembled	14501
assembled	14511

**Option 2: Vertical Separators for E-Tubes Series 1450 · 1480**

- They are used if only a vertical subdivision of the "Half"E-Tube (Series 1450) and the fully enclosed E-Tube (Series 1480) is required.
- Standard subdivision with Vertical Separator, slotted 14511, for combinations with Full-Width Shelf 111.X
- Standard: Vertical Separators are assembled every other chain link.

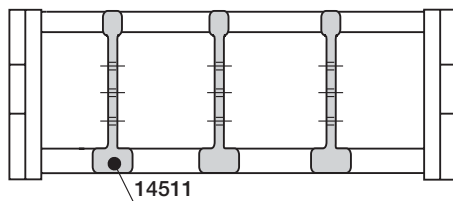

**Option 3: Full-Width Shelves for E-Chains® Series 1400 · 1500 and E-Tubes Series 1450 · 1480**

- For applications involving many thin cables with similar or identical diameters
- Full-Width Shelf 111.X can be combined with Vertical Separator, slotted 14011 (E-Chain®) and Vertical Separator, slotted 14511 (E-Tube/"Half" E-Tube)

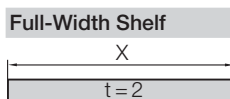
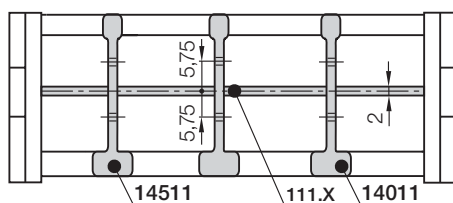

Width X [mm]	Part No. unassembled	Part No. assembled
015	110.15	111.15
020	110.20	111.20
025	110.25	111.25
038	110.38	111.38
050	110.50	111.50

Width X [mm]	Part No. unassembled	Part No. assembled
068	110.68	111.68
080	110.80	111.80
100	110.100	111.100
125	110.125*	111.125*

\*upon request



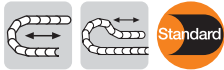

**The Standard - one-piece Mounting Brackets - pivoting**

- Recommended for unsupported and gliding applications
- Well suited for tight installation conditions
- Integrated multilevel strain relief
- Easy to assemble
- Various mounting positions

Moving end with bore (outer link) 14...3PZ

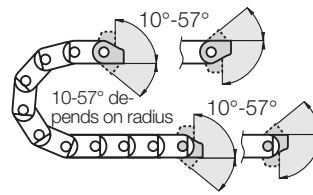

14...4PZ Fixed end with pin (inner link)

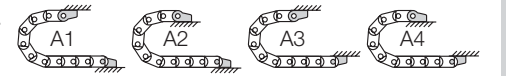

Possible installation conditions for assembled mounting brackets ▶ Order example "preassembled" below

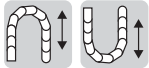

**Einteilige Anschlußelemente - locking**

- Recommended for unsupported and gliding applications
- Furthermore:**
  - At very high speed and/or acceleration
  - If space is limited for height (the  $H_F$  measurement)
  - Various mounting positions

Moving end with bore (outer link) 14...1PZ

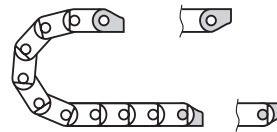

14...2PZ Fixed end with pin (inner link)

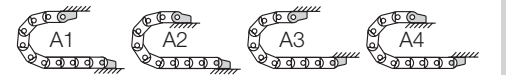

Possible installation conditions for assembled mounting brackets ▶ Order example "preassembled" below

14...3PZ Standard! (pivoting)

14...1PZ (locking)

Moving end

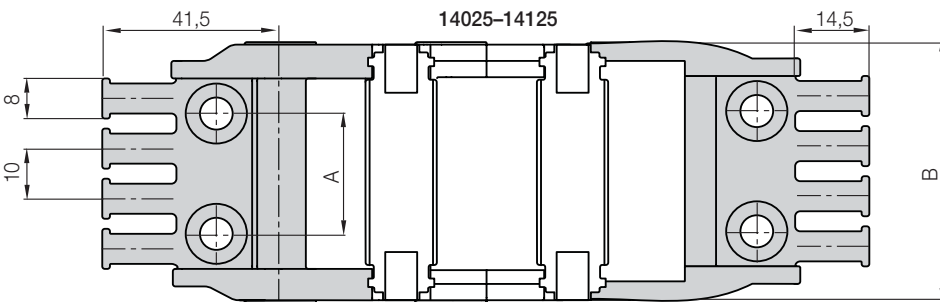
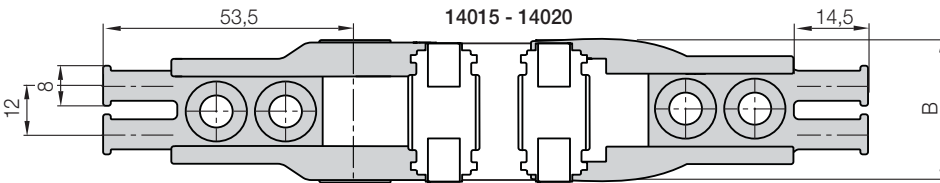

**Dimensions and order configurations**

Strain relief is possible on the moving end and/or the fixed end.

Part No. structure (pivoting)

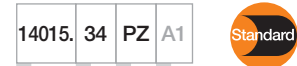

A... must be indicated on preassembled configurations  
With assembled strain relief tiwrap plates  
Full set pivoting = 34  
Mounting brackets for selected chain type

Full set, for both ends:

14015. 34 PZ + tiwrap plate

Single-part order:

14015. 3 PZ + tiwrap plate

Mounting bracket with bore

14015. 4 PZ + tiwrap plate

Mounting bracket with pin

Part No. structure (locking)

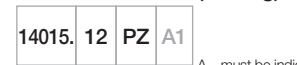

A... must be indicated on preassembled configurations  
With assembled strain relief tiwrap plates  
Full set pivoting = 12  
Mounting brackets for selected chain type

Full set, for both ends:

14015. 12 PZ + tiwrap plate

Single-part order:

14015. 1 PZ + tiwrap plate

Mounting bracket with bore

14015. 2 PZ + tiwrap plate

Mounting bracket with pin

For E-Chain®:	Part No. full set with tiwrap plate	Dim.A [mm]	Dim.B [mm]	Number of teeth
1400 - 1500.015 ▶	14015. [ ] PZ	-	28,5	2
1400 - 1500.020 ▶	14020. [ ] PZ	-	33,5	2
1400 - 1500.025 ▶	14025. [ ] PZ	13	38,5	2
1400 - 1500.038 ▶	14038. [ ] PZ	24	51,5	4
1400 - 1500.050 ▶	14050. [ ] PZ	36	63,5	6
1400 - 1500.068 ▶	14068. [ ] PZ	54	81,5	7
1400 - 1500.080 ▶	14080. [ ] PZ	66	93,5	8
1400 - 1500.100 ▶	14100. [ ] PZ	86	113,5	10
1400 - 1500.125 ▶	14125. [ ] PZ	111	138,5	13

Please add the Part No. with the requested index - 34 for the pivoting configuration

e.g. 14015. 34 PZ or 12 for the locking configuration e.g. 14015. 12 PZ

For the preassembled mode please add the index A1 ... A4 e.g. 14015. 34 PZ A1

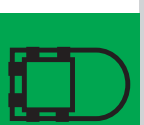

on request

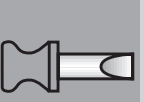

▶ page 5.73

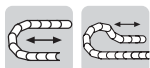

Moving end with bore  
(outer link) 15000...3PZ(B)

### Mounting bracket - polymer

- Recommended for unsupported and gliding applications
- Well suited for tight installation conditions
- Strain relief with detachable tie-wrap plates
- Variable traverse angle for flexible assembly
- The twistability of the E-Chain® and the option to assemble the mounting brackets on the fixed end and/or the moving end, enable various installation options

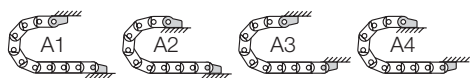
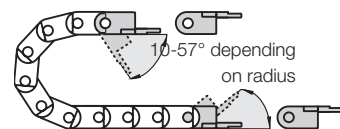

Possible installation conditions for assembled mounting brackets ▶ Order example "preassembled" below

15000...4PZ(B) Fixed end  
with pin (inner link)

### Dimensions and order configurations

Strain relief is possible on the moving end and/or the fixed end.

15000...3PZ(B)  
Moving end

15000...4PZ(B)  
Fixed end

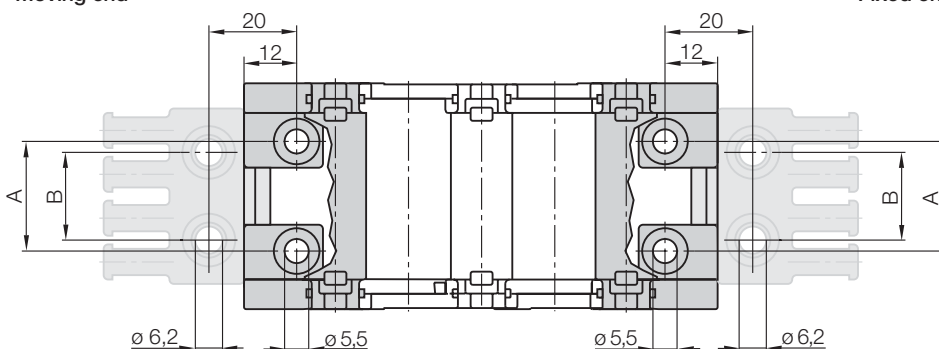

#### Part No. structure

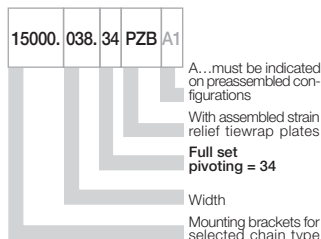

#### Full set, for both ends:

15000.038.34.PZB+tiewrap plate

#### Single-part order:

15000.038.3.PZB+tiewrap plate

Mounting bracket with bore

15000.038.4.PZB+tiewrap plate

Mounting bracket with pin

For E-Chain®	Part No. full set with tiewrap plate	Part No. full set without tiewrap plate	Dim. A [mm]	Dim. B [mm]
1400 – 1500.015 ▶	–	–	–	–
1400 – 1500.020 ▶	–	–	–	–
1400 – 1500.025 ▶	15000.025. 34 PZB	15000.025. 34 PZ	12	15
1400 – 1500.038 ▶	15000.038. 34 PZB	15000.038. 34 PZ	25	20
1400 – 1500.050 ▶	15000.050. 34 PZB	15000.050. 34 PZ	37	30
1400 – 1500.068 ▶	15000.068. 34 PZB	15000.068. 34 PZ	55	40
1400 – 1500.080 ▶	15000.080. 34 PZB	15000.080. 34 PZ	67	60
1400 – 1500.100 ▶	15000.100. 34 PZB	15000.100. 34 PZ	87	80
1400 – 1500.125 ▶	15000.125. 34 PZB	15000.125. 34 PZ	113	105

For the preassembled mode please add the index A1 ... A4 e.g. 15000.038. 34 PZB A1

Phone +49- (0) 22 03-96 49-800  
Fax +49- (0) 22 03-96 49-222

igus® GmbH  
51147 Köln

Internet: www.igus.de  
E-mail: info@igus.de

# 1400·1450·1480·1500 Steel Mounting Brackets



## Steel mounting bracket - locking

- Locked connections
- One part for all chain widths
- Electrically conductive
- Bolted connection outside of chain cross-section possible

Moving end with bore  
(outer link) 14000....1

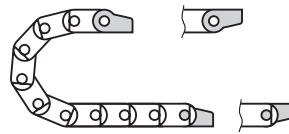

14000...2 Fixed end  
with pin (inner link)

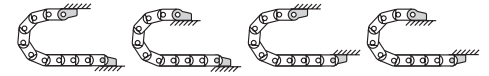

Possible installation conditions -  
Further installation angles ► installation sketch

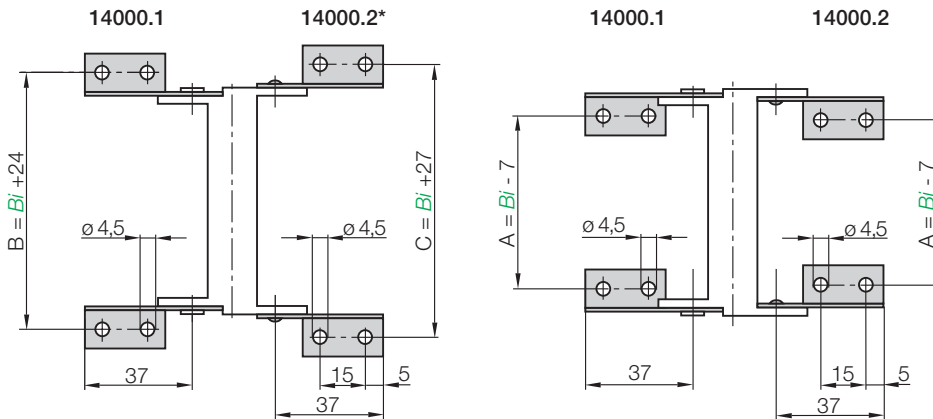

## Dimensions and order configurations

\*pivoting with no stop, (360°).  
Screw-on area of the mounting brackets can be on the interior or exterior.

For E-Chain®	Part No. full set	Dim. A [mm]	Dim. B [mm]	Dim. C [mm]
1400 - 1500.015 ►	14000.12	8	39	42
1400 - 1500.020 ►	14000.12	13	44	47
1400 - 1500.025 ►	14000.12	18	49	52
1400 - 1500.038 ►	14000.12	31	62	65
1400 - 1500.050 ►	14000.12	43	74	77
1400 - 1500.068 ►	14000.12	61	92	95
1400 - 1500.080 ►	14000.12	73	104	107
1400 - 1500.100 ►	14000.12	93	124	127
1400 - 1500.125 ►	14000.12	118	149	152

14000.12 Full set, 4 parts  
2 with pin / 2 with bore

### Single-part order:

14000.1 Mounting bracket with bore, 1 part left / right  
14000.2 Mounting bracket with pin, 1 part left / right

Phone +49- (0) 22 03-96 49-800  
Fax +49- (0) 22 03-96 49-222

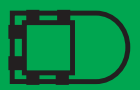

on request



► page 5.73



**Tiewrap plate as individual part - Series 2000**

As individual component screwed on KMA. Can be plugged in the mounting brackets, **more Details**

► **chapter 10**

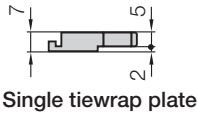

Single tiewrap plate

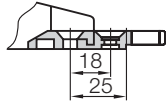

Shown assembled

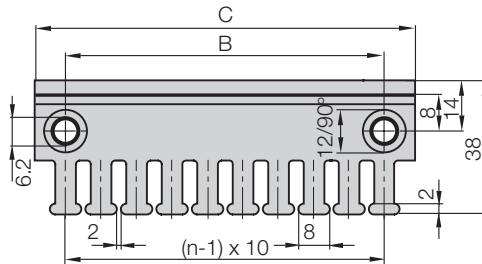

Tiewrap plate	No. of teeth <i>n</i>	Dim. C [mm]	Dim. B [mm]
2020.ZB	3	30	15
2030.ZB	4	40	20
2040.ZB	5	50	30
2050.ZB	6	60	40
2070.ZB	8	80	60
2090.ZB = (2030.ZB + 2040.ZB)	9	90	-
2100.ZB	10	100	80
2125.ZB = (2050.ZB + 2050.ZB)	12	120	-



**Cable tiewraps as individual part**

Cable tiewraps (100-piece bag)	Width x length	max. Ø	Tensile strength
CFB.001	4,8 x 150 mm	36 mm	222 N



Other strain relief elements - optional ► **chapter 10**