



**VOIDLESS HERMETICALLY SEALED 1.5 WATT
GLASS ZENER DIODES**
Qualified per MIL-PRF-19500/406

Qualified Levels:
JAN, JANTX,
JANTXV and JANS

DESCRIPTION

This Zener voltage regulator series is military qualified to MIL-PRF-19500/406 and is ideal for high-reliability applications where a failure cannot be tolerated. These industry-recognized 1.5 watt Zener voltage regulators are hermetically sealed with void-less glass construction using an internal metallurgical bond. It includes Zener selections from 3.3 to 200 volts in standard 5% tolerance. 1% and 2% tolerance versions are also available. Microsemi also offers numerous other Zener products to meet higher and lower power ratings in both thru-hole and surface mount packages.

Important: For the latest information, visit our website <http://www.microsemi.com>.

FEATURES

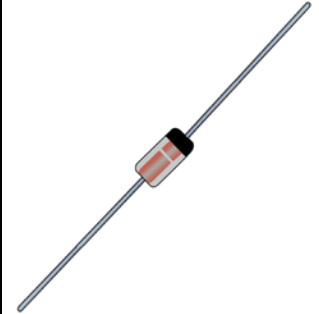
- Popular JEDEC registered series.
- Void-less hermetically sealed glass package.
- Triple-layer passivation.
- Extremely robust construction.
- Internal “Category 1” metallurgical bonds for 1N4462 thru 1N4496 and “Category III” for 1N6485 thru 1N6491 as well as 1N4460 and 1N4461.
- JAN, JANTX, JANTXV and JANS qualifications are available per MIL-PRF-19500/406.
- RoHS compliant versions available (commercial grade only).

APPLICATIONS / BENEFITS

- Regulates voltage over a broad operating current and temperature range.
- Extensive selection from 3.3 to 200 V.
- Standard voltage tolerances are plus/minus 5% with no suffix.
- Tighter tolerances available in plus or minus 2% or 1%.
- Flexible axial-lead mounting terminals.
- Non-sensitive to ESD per MIL-STD-750 method 1020.
- Inherently radiation hard as described in Microsemi [MicroNote 050](#).

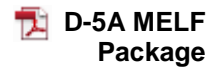
MAXIMUM RATINGS @ T_A = 25°C unless otherwise specified

Parameters/Test Conditions	Symbol	Value	Unit
Junction and Storage Temperature	T _J & T _{STG}	-65 to +175	°C
Steady State Power Dissipation @ T _L = +112 °C L = .375 inch (9.53 mm)	P _D	1.5	W
Thermal Resistance Junction-to-Lead @ .375 inch (9.52 mm) from body	R _{θJL}	42	°C/W
Thermal Impedance @ 10 ms	Z _{θJX}	Figure 3 Figure 4 Figure 4	°C/W
Forward Voltage @ 200 mA	V _F	1.0	V
@ 1.0 A		1.5	
Solder Temperature @ 10 s	T _{SP}	260	°C



DO-41 Package

Also available in:



[1N4460US – 1N4496US and
1N6485US – 1N6491US](#)

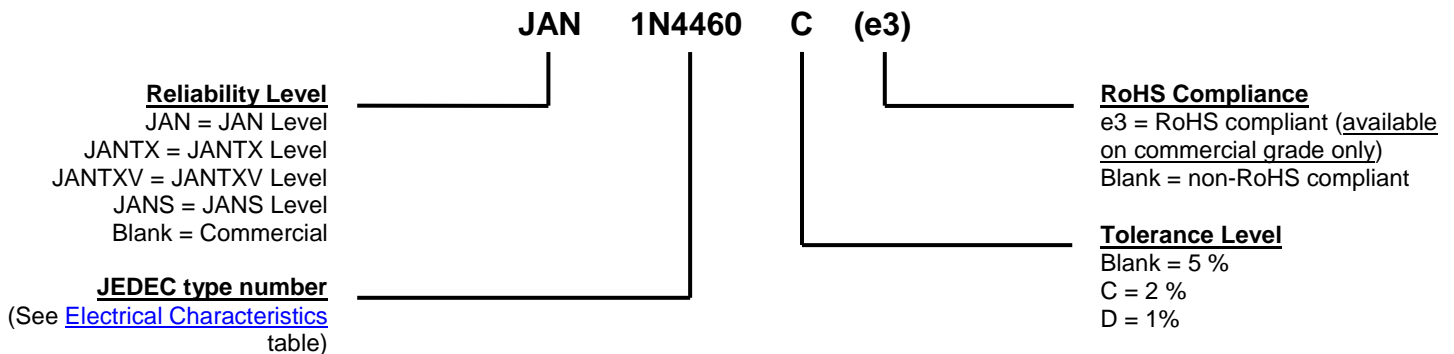
MSC – Lawrence
6 Lake Street,
Lawrence, MA 01841
Tel: 1-800-446-1158 or
(978) 620-2600
Fax: (978) 689-0803

MSC – Ireland
Gort Road Business Park,
Ennis, Co. Clare, Ireland
Tel: +353 (0) 65 6840044
Fax: +353 (0) 65 6822298

Website:
www.microsemi.com

MECHANICAL and PACKAGING

- CASE: Hermetically sealed voidless hard glass with tungsten slugs.
- TERMINALS: Tin/lead (Sn/Pb) or RoHS compliant matte/tin (commercial grade only) over copper.
- MARKING: Body coated in blue with part number.
- POLARITY: Cathode indicated by band.
- TAPE & REEL option: Standard per EIA-296. Consult factory for quantities.
- WEIGHT: 340 milligrams.
- See [Package Dimensions](#) on last page.

PART NOMENCLATURE

SYMBOLS & DEFINITIONS

Symbol	Definition
V_Z	Zener Voltage: The Zener voltage the device will exhibit at a specified current (I_Z) in its breakdown region.
I_Z, I_{ZT}, I_{ZK}	Regulator Current: The dc regulator current (I_Z), at a specified test point (I_{ZT}), near breakdown knee (I_{ZK}).
Z_{ZT} or Z_{ZK}	Dynamic Impedance: The small signal impedance of the diode when biased to operate in its breakdown region at a specified rms current modulation (typically 10% of I_{ZT} or I_{ZK}) and superimposed on I_{ZT} or I_{ZK} respectively.
V_F	Maximum Forward Voltage: The maximum forward voltage the device will exhibit at a specified current.
I_R	Maximum Reverse Current: The maximum reverse (leakage) current that will flow at the specified voltage and temperature.
I_{ZM}	Maximum Regulator (Zener) Current: The maximum rated dc current for the specified power rating.
I_{ZSM}	Maximum Zener Surge Current: The non-repetitive peak value of Zener surge current at a specified wave form.

ELECTRICAL CHARACTERISTICS @ 25 °C Case temperature

TYPE	NOMINAL ZENER VOLTAGE V_Z	TEST CURRENT I_{ZT}	MAXIMUM DYNAMIC IMPEDANCE $Z_{ZT} @ I_{ZT}$	MAXIMUM KNEE IMPEDANCE $Z_{ZK} @ I_{ZK}$		MAXIMUM REVERSE CURRENT $I_R @ V_R$		MAXIMUM CONTINUOUS CURRENT I_{ZM} (Note 1)	SURGE CURRENT @ 8.3 ms square wave I_{ZSM}
	Volts	mA	Ohms	Ohms	mA	μA	Volts	mA	Amps
1N4460	6.2	40.0	4	200	1.0	10.0	3.72	230	2.3
1N4461	6.8	37.0	2.5	200	1.0	5.0	4.08	210	2.1
1N4462	7.5	34.0	2.5	400	.5	1.0	4.50	191	1.9
1N4463	8.2	31.0	3	400	.5	.50	4.92	174	1.7
1N4464	9.1	28.0	4	500	.5	.30	5.46	157	1.6
1N4465	10.0	25.0	5	500	.25	.30	8.00	143	1.4
1N4466	11.0	23.0	6	550	.25	.30	8.80	130	1.3
1N4467	12.0	21.0	7	550	.25	.20	9.60	119	1.2
1N4468	13.0	19.0	8	550	.25	.05	10.4	110	1.1
1N4469	15.0	17.0	9	600	.25	.05	12.0	95	.95
1N4470	16.0	15.5	10	600	.25	.05	12.8	90	.90
1N4471	18.0	14.0	11	650	.25	.05	14.4	79	.79
1N4472	20.0	12.5	12	650	.25	.05	16.0	71	.71
1N4473	22.0	11.5	14	650	.25	.05	17.6	65	.65
1N4474	24.0	10.5	16	700	.25	.05	19.2	60	.60
1N4475	27.0	9.5	18	700	.25	.05	21.6	53	.53
1N4476	30.0	8.5	20	750	.25	.05	24.0	48	.48
1N4477	33.0	7.5	25	800	.25	.05	26.4	43	.43
1N4478	36.0	7.0	27	850	.25	.05	28.8	40	.40
1N4479	39.0	6.5	30	900	.25	.05	31.2	37	.37
1N4480	43.0	6.0	40	950	.25	.05	34.4	33	.33
1N4481	47.0	5.5	50	1000	.25	.05	37.6	30	.30
1N4482	51.0	5.0	60	1100	.25	.05	40.8	28	.28
1N4483	56.0	4.5	70	1300	.25	.25	44.8	26	.26
1N4484	62.0	4.0	80	1500	.25	.25	49.6	23	.23
1N4485	68.0	3.7	100	1700	.25	.25	54.4	21	.21
1N4486	75.0	3.3	130	2000	.25	.25	60.0	19	.19
1N4487	82.0	3.0	160	2500	.25	.25	65.6	17	.17
1N4488	91.0	2.8	200	3000	.25	.25	72.8	16	.16
1N4489	100.0	2.5	250	3100	.25	.25	80.0	14	.14
1N4490	110.0	2.3	300	4000	.25	.25	88.0	13	.13
1N4491	120.0	2.0	400	4500	.25	.25	96.0	12	.12
1N4492	130.0	1.9	500	5000	.25	.25	104.0	11	.11
1N4493	150.0	1.7	700	6000	.25	.25	120.0	9.5	.095
1N4494	160.0	1.6	1000	6500	.25	.25	128.0	8.9	.089
1N4495	180.0	1.4	1300	7000	.25	.25	144.0	7.9	.079
1N4496	200.0	1.2	1500	8000	.25	.25	160.0	7.2	.072
1N6485	3.3	76.0	10	400	1.0	50	1.0	433	4.2
1N6486	3.6	69.0	10	400	1.0	50	1.0	397	3.9
1N6487	3.9	64.0	9	400	1.0	35	1.0	366	3.6
1N6488	4.3	58.0	9	400	1.0	5.0	1.0	332	3.3
1N6489	4.7	53.0	8	500	1.0	4.0	1.0	304	3.0
1N6490	5.1	49.0	7	500	1.0	1.0	1.0	280	2.7
1N6491	5.6	45.0	5	600	1.0	0.5	2.0	255	2.5

NOTE: 1. See "[Maximum Ratings](#)" for P_D temperature conditions for leaded package where I_{ZM} is applicable.

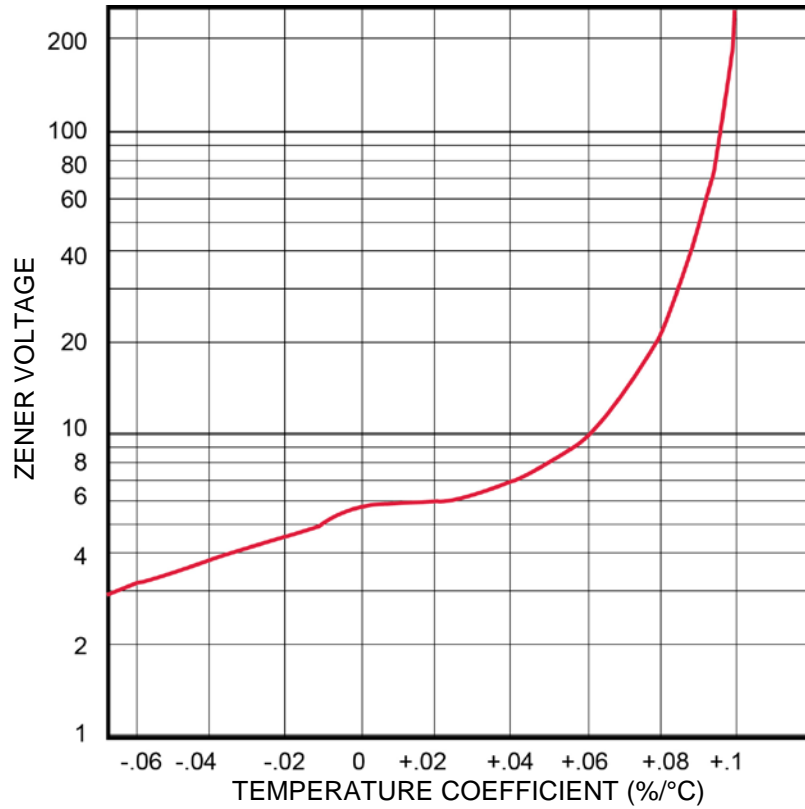
GRAPHS


FIGURE 1
Temperature Coefficient Characteristics

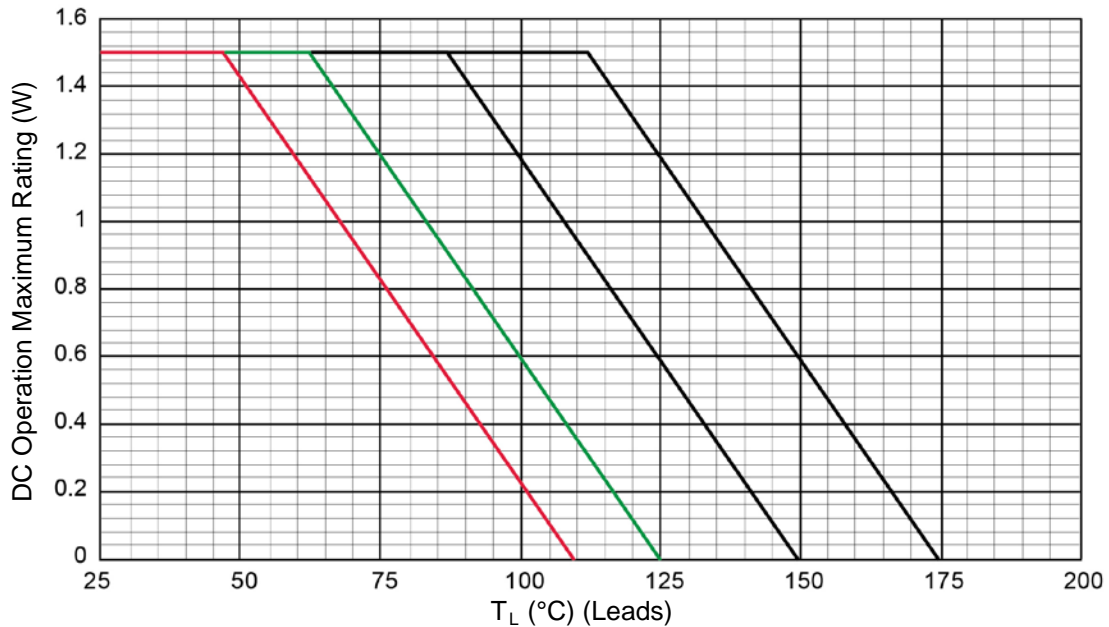


FIGURE 2
Temperature-Power Derating Curve

GRAPHS (continued)

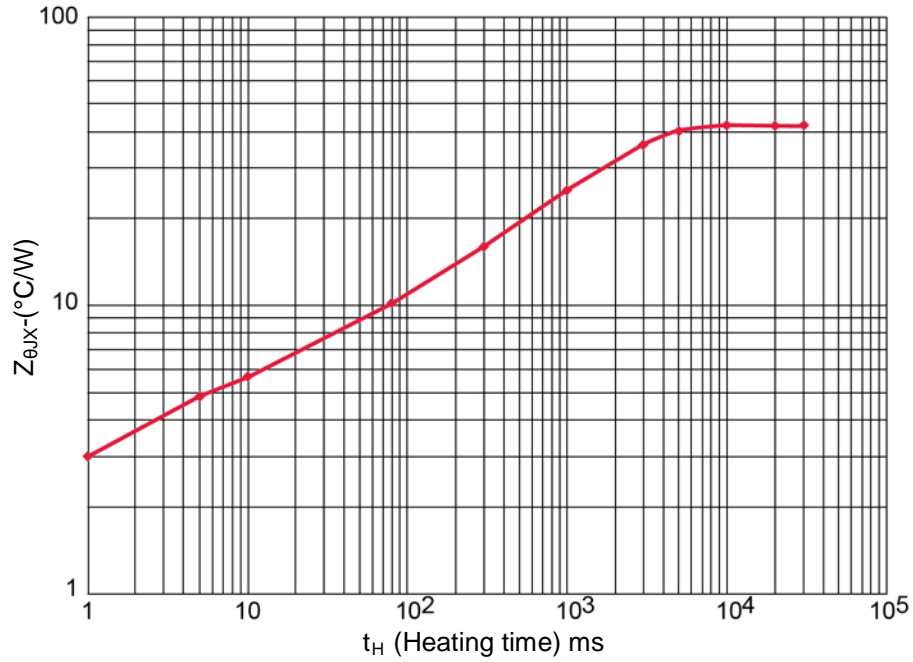


FIGURE 3
Thermal Impedance Curve for 1N4462 through 1N4496

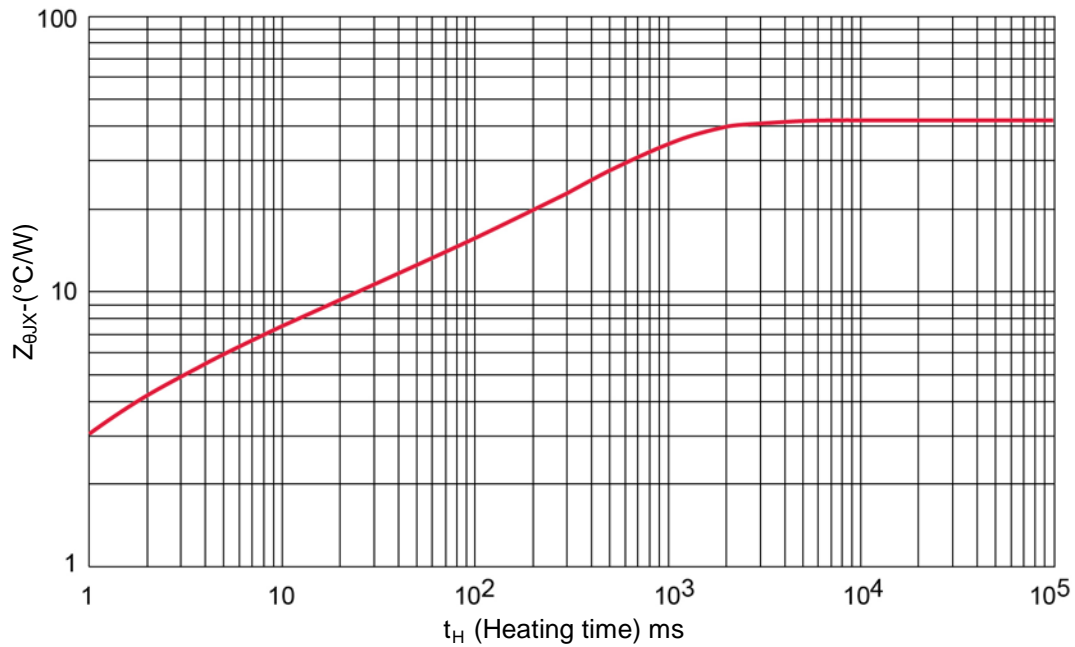
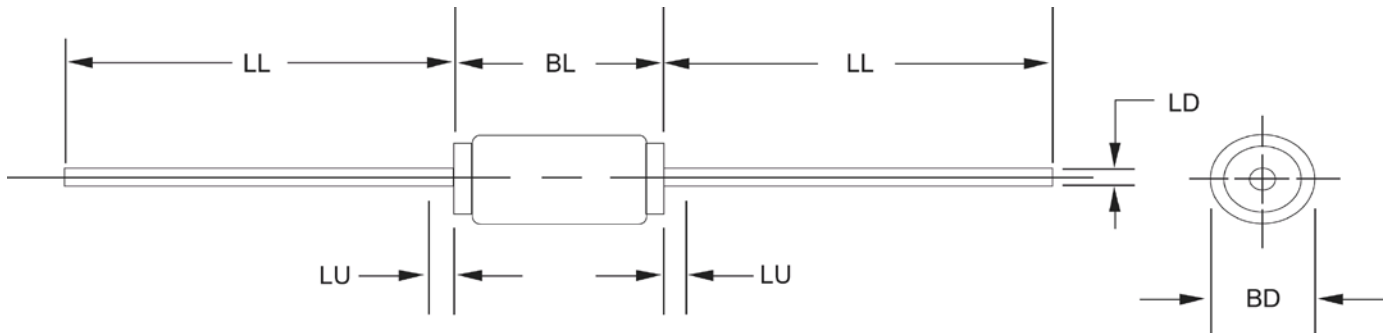


FIGURE 4
Thermal Impedance Curve for 1N6485 through 1N6491 and 1N4460 through 1N4461

PACKAGE DIMENSIONS

NOTES:

1. Dimensions are in inches.
2. Millimeters are given for general information only.
3. Package contour optional with BD and length BL. Heat slugs, if any, shall be included within this cylinder length but shall not be subject to minimum limit of BD.
4. The specified lead diameters apply in the zone between .050 inch (1.27 mm) from the diode body and the end of the lead.
5. In accordance with ASME Y14.5M, diameters are equivalent to Φ x symbology.

Ltr	DIMENSIONS				Notes
	INCH		MILLIMETERS		
	Min	Max	Min	Max	
BD	.060	.085	1.52	2.16	3
BL	.106	.160	2.69	4.06	3
LD	.028	.032	0.71	0.81	
LL	.800	1.300	20.32	33.02	
LU		.050		1.27	4

X-ON Electronics

Largest Supplier of Electrical and Electronic Components

Click to view similar products for [Zener Diodes](#) category:

Click to view products by [Microsemi](#) manufacturer:

Other Similar products are found below :

[MMSZ5245BS-7-F](#) [RKZ13B2KG#P1](#) [RKZ5.6B2KJ#R1](#) [EDZTE6113B](#) [EDZTE6116B](#) [EDZTE616.8B](#) [1N747A](#) [1N966B](#) [NTE5116A](#)
[NTE5121A](#) [NTE5139A](#) [NTE5147A](#) [NTE5152A](#) [NTE5156A](#) [NTE5164A](#) [JANS1N4974US](#) [SMAJ4764A-TP](#) [RKZ5.1BKU#P6](#)
[3SMAJ5946B-TP](#) [3SMAJ5950B-TP](#) [3SMBJ5920B-TP](#) [3SMBJ5925B-TP](#) [TDZTR24](#) [441774C](#) [MMSZ4678-TP](#) [BZG04-36](#) [BZG05C9V1-](#)
[HE3-TR](#) [HZM30NBTR-E](#) [UDZTE-175.1B](#) [3SMAJ5945B-TP](#) [3SMAJ5947B-TP](#) [3SMBJ5941B-TP](#) [DL4746A-TP](#) [RKZ18B2KK#R1](#)
[RKZ10B2KL#R1](#) [RKZ6.8B2KL#R1](#) [RKZ8.2B2KL#R1](#) [DZ2S240M0L](#) [SMAZ27-TP](#) [SMBZ5920B-E3/52](#) [ZMM3.0](#) [RD16UM-T1-A](#) [RD39S-](#)
[T1-A](#) [RD9.1S-T1-A](#) [RD10S-T1-A](#) [RD20S-T1-A](#) [RD2.2S-T1-A](#) [RD2.7UM-T1-A](#) [HZM24NB1TL-E](#) [HZM2.7NB2TL-E](#)