

Protection Equipment



5/2	Introduction
	3RV Circuit Breakers/Motor Starter Protectors up to 100 A
5/5	General data
5/7	For motor protection
5/11	For motor protection with overload relay function
5/12	For starter combinations
5/13	For transformer protection
5/14	For fuse monitoring
5/15	For system protection according to UL 489/CSA C22.2 No. 5-02
5/16	For transformer protection according to UL 489/CSA C22.2 No.5-02
5/17	For distance protection
	<u>Accessories</u>
5/18	Mountable accessories
5/22	Busbar accessories
5/25	Rotary operating mechanisms
5/27	Mounting accessories
5/31	Enclosures and front plates
	3RV Molded Case Motor Starter Protectors up to 800 A
5/34	General data
5/35	For motor protection
5/36	For starter combinations
	<u>Accessories</u>
5/37	Mountable accessories
5/38	Rotary operating mechanisms
	Overload Relays
5/39	General data
	<u>3RU1 Thermal Overload Relays</u>
5/43	3RU11 for standard applications
5/47	Accessories
	<u>3RB2 Solid-State Overload Relays</u>
5/48	3RB20, 3RB21 for standard applications
5/56	3RB22, 3RB23 for high-feature applications
5/60	Accessories

Protection Equipment

Introduction

Overview



Type	3RV10	3RV11	3RV13	3RV14	3RV16	3RV16	3RV17	3RV18
3RV1 circuit breakers/motor starter protectors up to 100 A								
Uses								
System protection	✓ ¹⁾	✓ ¹⁾	--	--	--	--	✓	✓
Motor protection	✓	--	--	--	--	--	--	--
Motor protection with overload relay function	--	✓	--	--	--	--	--	--
Starter combinations	--	--	✓	--	--	--	--	--
Transformer protection	--	--	--	✓	--	--	✓	✓
Fuse monitoring	--	--	--	--	✓	--	--	--
Voltage transformer circuit breakers for distance protection	--	--	--	--	--	✓	--	--
Size	S00, S0, S2, S3	S0, S2, S3	S0, S2, S3	S0, S2	S00	S00	S0, S3	S0
Rated current I_n								
Size S00	A to 12	--	--	--	0.2	to 3	--	--
Size S0	A to 25	to 25	to 25	to 20	--	--	to 22	to 20
Size S2	A to 50	to 50	to 50	to 40	--	--	--	--
Size S3	A to 100	to 100	to 100	--	--	--	to 70	--
Rated operational voltage U_e acc. to IEC	V 690 AC ²⁾	690 AC ²⁾	690 AC ²⁾	690 AC ²⁾	690 AC ²⁾	400 AC	690 AC	690 AC
Rated frequency	Hz 50/60	50/60	50/60	50/60	50/60	16 ² / ₃ ... 60	50/60	50/60
Trip class	CLASS 10 CLASS 20	CLASS 10	--	CLASS 10	--	--	--	--
Thermal overload release	A 0.11 ... 0.16 to A 80 ... 100	0.11 ... 0.16 to 80 ... 100	None ³⁾	0.11 ... 0.16 to 28 ... 40	0.2	1.4 ... 3	0.16 ... 70 non-adjustable	0.16 ... 20 non-adjustable
Electronic trip units								
A multiple of the rated current	13 times	13 times	13 times	20 times	6 times	4 ... 7 times	13 times	20 times
Short-circuit breaking capacity I_{cu} at 400 V AC	kA 50/100	50/100	50/100	50/100	100	50	4) 13 times	4) 20 times

Accessories

For sizes	S00 S0 S2 S3	S0 S2 S3	S0 S2 S3	S0 S2	S00	S00	S0, S3	S0
Auxiliary switches	✓ ✓ ✓ ✓	✓ ✓ ✓	✓ ✓ ✓	✓ ✓	✓	✓	✓ ⁵⁾	✓ ⁵⁾
Signal switch	-- ✓ ✓ ✓	✓ ✓ ✓	✓ ✓ ✓	✓ ✓	--	--	--	--
Undervoltage trip units	✓ ✓ ✓ ✓	-- -- --	✓ ✓ ✓	✓ ✓	✓	✓	✓	✓
Shunt trip units	✓ ✓ ✓ ✓	-- -- --	✓ ✓ ✓	✓ ✓	✓	✓	✓	✓
Isolator modules	-- ✓ ✓ --	✓ ✓ --	✓ ✓ --	✓ ✓	--	--	--	--
Insulated three-phase busbar systems	✓ ✓ ✓ --	-- ✓ --	✓ ✓ --	✓ ✓	✓	✓	--	--
Busbar adapters	✓ ✓ ✓ ✓	✓ ✓ ✓	✓ ✓ ✓	✓ ✓	✓	✓	--	--
Door-coupling rotary operating mechanisms	-- ✓ ✓ ✓	✓ ✓ ✓	✓ ✓ ✓	✓ ✓	--	--	✓	✓
Remote motorized operating mechanisms	-- -- ✓ ✓	-- ✓ ✓	-- ✓ ✓	-- ✓	--	--	--	--
Link modules	✓ ✓ ✓ ✓	✓ ✓ ✓	✓ ✓ ✓	✓ ✓	✓	✓	--	--
Enclosures for surface mounting	✓ ✓ ✓ --	✓ ✓ --	✓ ✓ --	✓ ✓	✓	✓	--	--
Enclosures for flush mounting	✓ ✓ -- --	✓ -- --	✓ -- --	✓ --	✓	✓	--	--
Front plates	✓ ✓ ✓ ✓	✓ ✓ ✓	✓ ✓ ✓	✓ ✓	✓	✓	--	--
Infeed system	✓ ✓ -- --	-- -- --	✓ -- --	✓ --	--	--	--	--

¹⁾ For symmetrical loading of the three phases.

²⁾ 500 V AC with molded-plastic enclosure.

³⁾ For overload protection of the motors, appropriate overload relays must be used.

⁴⁾ According to UL 489

- at 480 Y/277 V AC: for size S0 50 kA, for size S3 65 kA;

- at 480 V AC: for size S3 (10 A up to 30 A) 65 kA.

⁵⁾ Only lateral auxiliary switches can be fitted.

✓ Has this function or can use this accessory

-- Does not have this function or cannot use this accessory



Type	3RV10			3RV13					
3RV1 molded case motor starter protectors up to 800 A									
Uses									
Motor protection	✓			--					
Starter combinations	--			✓					
Switching capacity	Standard switching capacity			Standard switching capacity			Increased switching capacity		
Size	3RV10 63	3RV10 73	3RV10 83	3RV13 53	3RV13 63	3RV13 73	3RV13 83	3RV13 64	3RV13 74
Rated current I_n	A 100, 160, 200	400	630	1 ... 32	100, 160, 250	400, 630	630, 800	100, 160, 250	400
Rated operational voltage U_e acc. to IEC	690 AC			690 AC					
Rated frequency	Hz 50/60			50/60					
Trip class	CLASS 10A CLASS 10 CLASS 20 CLASS 30			-- ¹⁾					
Thermal overload release	A 40 ... 100 to A 252 ... 630			None ¹⁾					
Electronic trip units A multiple of the rated current	Adjustable, 6 ... 13 times			Non-adjustable 1 A ... 12.5 A: 13 times; adjustable 20 A, 32 A: 6 ... 12 times		1 ... 10 times			
Short-circuit breaking capacity I_{cu} at 400 V AC	kA 120	120	100	85	120	120	100	200	200
Trip unit	TU 4			TU 1: 1 A ... 12.5 A; TU 2: 20 A, 32 A		TU 3			

Accessories

For molded case motor starter protectors	3RV10 63	3RV10 73	3RV10 83	3RV13 53	3RV13 63	3RV13 73	3RV13 83	3RV13 64	3RV13 74
Auxiliary switches	✓	✓	✓	✓	✓	✓	✓	✓	✓
Undervoltage trip units	✓	✓	✓	✓	✓	✓	✓	✓	✓
Shunt trip units	✓	✓	✓	✓	✓	✓	✓	✓	✓
Rotary operating mechanisms	✓	✓	✓	✓	✓	✓	✓	✓	✓
Connection methods									
• Front-extended terminals	✓	✓	--	✓	✓	✓	--	✓	✓
• Front-accessible cable terminals	✓	✓	✓	✓	✓	✓	✓	✓	✓
• Rear-accessible terminals	✓	✓	✓	✓	✓	✓	✓	✓	✓

¹⁾ For overload protection of the motors, appropriate overload relays must be used.

✓ Has this function or can use this accessory

-- Does not have this function or cannot use this accessory

Protection Equipment

Introduction



Type		3RU11	3RB20	3RB21	3RB22/3RB23
Overload relays up to 630 A					
Uses					
System protection		✓ ¹⁾	✓ ¹⁾	✓ ¹⁾	✓ ¹⁾
Motor protection		✓	✓	✓	✓
Alternating current, three-phase		✓	✓	✓	✓
Alternating current, single-phase		✓	--	--	✓
DC current		✓	--	--	--
Size of contactor		S00, S0, S2, S3	S00 ... S12	S00 ... S12	S00 ... S12
Rated operational current I_e					
Size S00	A	Up to 12	Up to 12	Up to 12	Up to 25
Size S0	A	Up to 25	Up to 25	Up to 25	Up to 25
Size S2	A	Up to 50	Up to 50	Up to 50	Up to 100
Size S3	A	Up to 100	Up to 100	Up to 100	Up to 100
Size S6	A	--	Up to 200	Up to 200	Up to 200
Size S10/S12, Size 14 (3TF6)	A	--	Up to 630	Up to 630	Up to 630
Rated operational voltage U_e	V	690/1000 AC ²⁾	690/1000 AC ³⁾	690/1000 AC ³⁾	690/1000 AC ⁴⁾
Rated frequency	Hz	50/60	50/60	50/60	50/60
Trip class		CLASS 10	CLASS 10, CLASS 20	CLASS 5, 10, 20, 30 adjustable	CLASS 5, 10, 20, 30 adjustable
Thermal overload release	A	0.11 ... 0.16	--	--	--
	A	to 80 ... 100	--	--	--
Solid-state overload release	A	--	0.1 ... 0.4	0.1 ... 0.4	0.3 ... 3
	A	--	to 160 ... 630	to 160 ... 630	to 63 ... 630
Rating for induction motor at 400 V AC	kW	0.04	0.04 ... 0.09	0.04 ... 0.09	0.09 ... 1.1
	kW	to 45	to 90 ... 450	to 90 ... 450	to 37 ... 450

Accessories																						
For sizes	S00	S0	S2	S3	S00	S0	S2	S3	S6	S10/ S12	S00	S0	S2	S3	S6	S10/ S12	S00	S0	S2	S3	S6	S10/ S12
Terminal brackets for stand-alone installation	✓	✓	✓	✓	✓	✓	5)	5)	5)	5)	✓	✓	5)	5)	5)	5)	5)	5)	5)	5)	5)	5)
Mechanical RESET	✓	✓	✓	✓	✓	✓	✓	✓	✓	✓	✓	✓	✓	✓	✓	✓	--	--	--	--	--	--
Cable releases for RESET	✓	✓	✓	✓	✓	✓	✓	✓	✓	✓	✓	✓	✓	✓	✓	✓	--	--	--	--	--	--
Electrical remote RESET	✓	✓	✓	✓	--	--	--	--	--	--	Integrated in the unit						Integrated in the unit					
Terminal covers	--	--	✓	✓	--	--	--	✓	✓	✓	--	--	--	✓	✓	✓	--	--	--	✓	✓	✓
Sealable covers for setting knobs	Integrated in the unit				✓	✓	✓	✓	✓	✓	✓	✓	✓	✓	✓	✓	✓	✓	✓	✓	✓	✓

¹⁾ The units are responsible in the main circuit for overload protection of the assigned electrical loads (e. g. motors), feeder cable and other switching and protection devices in the respective load feeder.

²⁾ Size S3 up to 1000 V AC.

³⁾ Size S2 (only with straight-through transformer), S3, S6, S10, S12 up to 1000 V AC.

⁴⁾ With reference to the 3RB29 .6 current measuring modules.

⁵⁾ Stand-alone installation without accessories is possible.

✓ Has this function or can use this accessory

-- Does not have this function or cannot use this accessory

Overview

The following illustrations show our 3RV1 motor starter protectors with the accessories which can be mounted for the various sizes, see also "Introduction" --> "Overview".

S00 motor starter protectors with mountable accessories

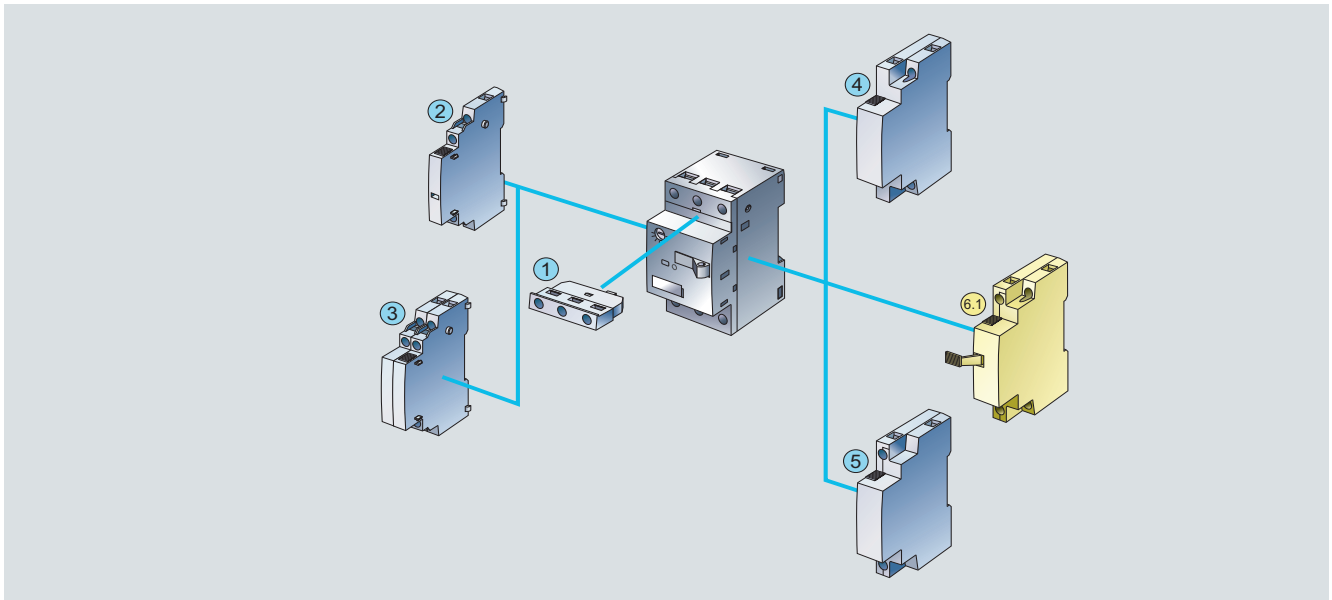

Motor starter protectors, sizes S0, S2 or S3, with mountable accessories

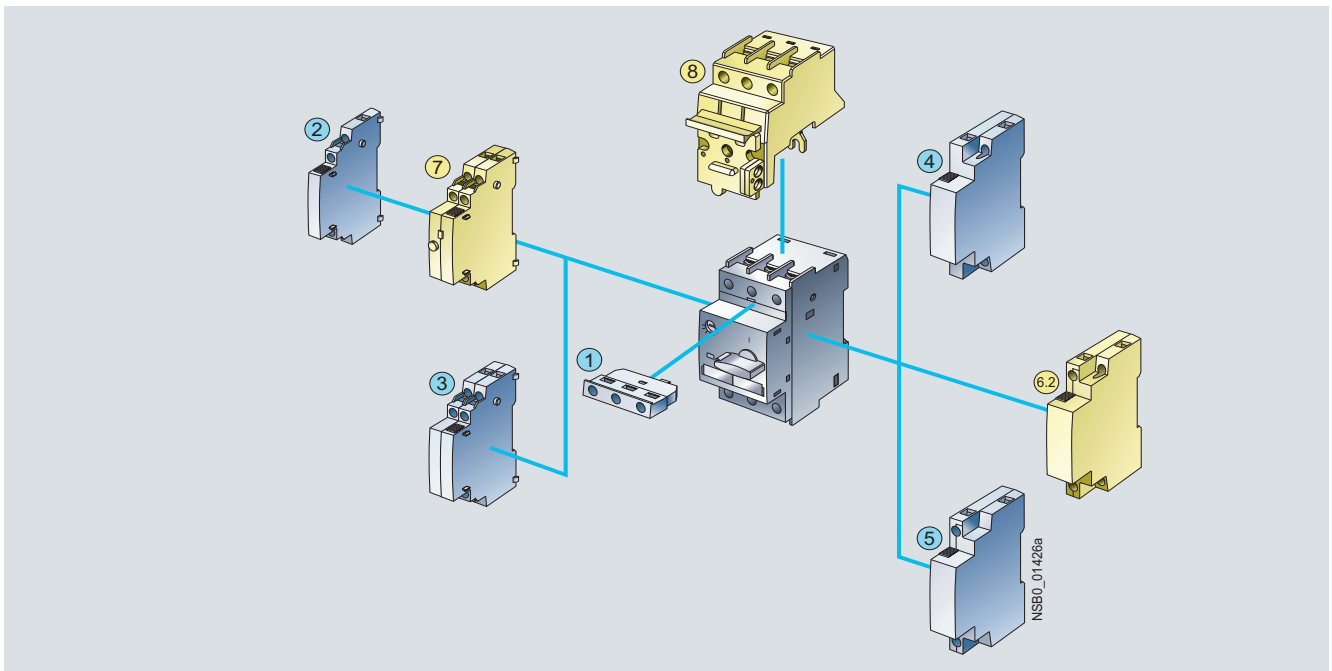

Mountable accessories for all sizes S00 ... S3

- ① Transverse auxiliary switch (can not be used with 3RV17 and 3RV18 circuit breakers)
- ② Lateral auxiliary switch with 2 contacts
- ③ Lateral auxiliary switch with 4 contacts
- ④ Shunt release
- ⑤ Undervoltage release

Mountable accessories

- ⑥.1 Undervoltage release with leading auxiliary contacts
- ⑥.2 Undervoltage release with leading auxiliary contacts
- ⑦ Alarm switch
- ⑧ Isolator module

for sizes

- S00
- S0 ... S3
- S0 ... S3
- S0 and S2

For accessories, see page 5/18.

3RV Motor Starter Protectors up to 100 A

General data



Size S0 motor starter protector

3RV1 motor starter protectors are compact, current limiting motor starter protectors which are optimized for load feeders. The motor starter protectors are used for switching and protecting induction motors of up to 45 kW at 400 V AC and for other loads with rated currents of up to 100 A.

Type of construction

The motor starter protectors are available in four sizes:

- Size S00 - width 45 mm, max. rated current 12 A, at 400 V AC suitable for induction motors up to 5.5 kW.
- Size S0 – width 45 mm, max. rated current 25 A, at 400 V AC suitable for induction motors up to 11 kW.
- Size S2 – width 55 mm, max. rated current 50 A, at 400 V AC suitable for induction motors up to 22 kW.
- Size S3 – width 70 mm, max. rated current 100 A, at 400 V AC suitable for induction motors up to 45 kW.

Note



Screw terminals



Cage Clamp terminals

The terminals are indicated in the selection and ordering data by orange backgrounds.

"Increased safety" type of protection EEx e according to ATEX directive 94/9/EC

The 3RV10 motor starter protectors are suitable for the overload protection of explosion-proof motors with "increased safety" type of protection EEx e;

see Chapter 20 "Appendix" --> "Standards and approvals" --> "Type overview of approved devices for explosion-protected areas (ATEX Explosion Protection)".

Application

Operating conditions

3RV1 motor starter protectors are suitable for use in any climate. They are intended for use in enclosed rooms in which no severe operating conditions (such as dust, caustic vapors, hazardous gases) prevail. When installed in dusty and damp areas, suitable enclosures must be provided.

3RV1 motor starter protectors can optionally be fed from the top or from below.

The permissible ambient temperatures, the maximum switching capacities, the tripping currents and other boundary conditions can be found in the technical specifications and tripping characteristics.

3RV1 motor starter protectors are suitable for operation in IT systems (IT networks). In this case, the different short-circuit breaking capacity in the IT system must be taken into account.

Since operational currents, starting currents and current peaks are different even for motors with identical power ratings due to the inrush current, the motor ratings in the selection tables are only guide values. The specific rated and start-up data of the motor to be protected is always paramount to the choice of the most suitable motor starter protector. This also applies to motor starter protectors for transformer protection.

Possible uses

The 3RV1 motor starter protectors can be used:

- For short-circuit protection
- For motor protection (also with overload relay function)
- For system protection
- For short-circuit protection for starter combinations
- For transformer protection
- As main control and EMERGENCY-STOP switches
- For fuse monitoring
- For use in IT systems (IT networks)
- For switching of DC currents
- As voltage transformer circuit breakers
- In areas subject to explosion hazard (ATEX)

More information is available under "[Configuration](#)".

3RV Motor Starter Protectors up to 100 A

For motor protection

Selection and ordering data

CLASS 10, without auxiliary switches

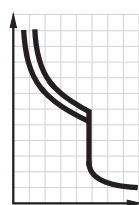

Rated current	Suitable for three-phase induction motors ¹⁾ with P	Setting range for thermal overload release	Instantaneous electronic trip unit	Short-circuit breaking capacity at 400 V AC	DT	Screw terminals	PU (UNIT, SET, M)	PS*	PG	Weight per PU approx.
I_n				I_{cu}						
A	kW	A	A	kA			Order No.	Price per PU		kg

Size S00



3RV10 11-0JA10

0.16	0.04	0.11 ... 0.16	2.1	100	▶	3RV10 11-0AA10	1	1 unit	101	0.230
0.2	0.06	0.14 ... 0.2	2.6	100	▶	3RV10 11-0BA10	1	1 unit	101	0.231
0.25	0.06	0.18 ... 0.25	3.3	100	▶	3RV10 11-0CA10	1	1 unit	101	0.233
0.32	0.09	0.22 ... 0.32	4.2	100	▶	3RV10 11-0DA10	1	1 unit	101	0.233
0.4	0.09	0.28 ... 0.4	5.2	100	▶	3RV10 11-0EA10	1	1 unit	101	0.235
0.5	0.12	0.35 ... 0.5	6.5	100	▶	3RV10 11-0FA10	1	1 unit	101	0.232
0.63	0.18	0.45 ... 0.63	8.2	100	▶	3RV10 11-0GA10	1	1 unit	101	0.233
0.8	0.18	0.55 ... 0.8	10	100	▶	3RV10 11-0HA10	1	1 unit	101	0.235
1	0.25	0.7 ... 1	13	100	▶	3RV10 11-0JA10	1	1 unit	101	0.233
1.25	0.37	0.9 ... 1.25	16	100	▶	3RV10 11-0KA10	1	1 unit	101	0.279
1.6	0.55	1.1 ... 1.6	21	100	▶	3RV10 11-1AA10	1	1 unit	101	0.281
2	0.75	1.4 ... 2	26	100	▶	3RV10 11-1BA10	1	1 unit	101	0.280
2.5	0.75	1.8 ... 2.5	33	100	▶	3RV10 11-1CA10	1	1 unit	101	0.281
3.2	1.1	2.2 ... 3.2	42	100	▶	3RV10 11-1DA10	1	1 unit	101	0.283
4	1.5	2.8 ... 4	52	100	▶	3RV10 11-1EA10	1	1 unit	101	0.281
5	1.5	3.5 ... 5	65	100	▶	3RV10 11-1FA10	1	1 unit	101	0.285
6.3	2.2	4.5 ... 6.3	82	100	▶	3RV10 11-1GA10	1	1 unit	101	0.288
8	3	5.5 ... 8	104	50	▶	3RV10 11-1HA10	1	1 unit	101	0.289
10	4	7 ... 10	130	50	▶	3RV10 11-1JA10	1	1 unit	101	0.284
12	5.5	9 ... 12	156	50	▶	3RV10 11-1KA10	1	1 unit	101	0.280

Size S0



3RV10 21-0JA10

0.16	0.04	0.11 ... 0.16	2.1	100	▶	3RV10 21-0AA10	1	1 unit	101	0.286
0.2	0.06	0.14 ... 0.2	2.6	100	▶	3RV10 21-0BA10	1	1 unit	101	0.288
0.25	0.06	0.18 ... 0.25	3.3	100	▶	3RV10 21-0CA10	1	1 unit	101	0.287
0.32	0.09	0.22 ... 0.32	4.2	100	▶	3RV10 21-0DA10	1	1 unit	101	0.286
0.4	0.09	0.28 ... 0.4	5.2	100	▶	3RV10 21-0EA10	1	1 unit	101	0.288
0.5	0.12	0.35 ... 0.5	6.5	100	▶	3RV10 21-0FA10	1	1 unit	101	0.287
0.63	0.18	0.45 ... 0.63	8.2	100	▶	3RV10 21-0GA10	1	1 unit	101	0.289
0.8	0.18	0.55 ... 0.8	10	100	▶	3RV10 21-0HA10	1	1 unit	101	0.287
1	0.25	0.7 ... 1	13	100	▶	3RV10 21-0JA10	1	1 unit	101	0.350
1.25	0.37	0.9 ... 1.25	16	100	▶	3RV10 21-0KA10	1	1 unit	101	0.353
1.6	0.55	1.1 ... 1.6	21	100	▶	3RV10 21-1AA10	1	1 unit	101	0.357
2	0.75	1.4 ... 2	26	100	▶	3RV10 21-1BA10	1	1 unit	101	0.356
2.5	0.75	1.8 ... 2.5	33	100	▶	3RV10 21-1CA10	1	1 unit	101	0.357
3.2	1.1	2.2 ... 3.2	42	100	▶	3RV10 21-1DA10	1	1 unit	101	0.356
4	1.5	2.8 ... 4	52	100	▶	3RV10 21-1EA10	1	1 unit	101	0.354
5	1.5	3.5 ... 5	65	100	▶	3RV10 21-1FA10	1	1 unit	101	0.358
6.3	2.2	4.5 ... 6.3	82	100	▶	3RV10 21-1GA10	1	1 unit	101	0.357
8	3	5.5 ... 8	104	100	▶	3RV10 21-1HA10	1	1 unit	101	0.356
10	4	7 ... 10	130	100	▶	3RV10 21-1JA10	1	1 unit	101	0.361
12.5	5.5	9 ... 12.5	163	100	▶	3RV10 21-1KA10	1	1 unit	101	0.358
16	7.5	11 ... 16	208	50	▶	3RV10 21-4AA10	1	1 unit	101	0.366
20	7.5	14 ... 20	260	50	▶	3RV10 21-4BA10	1	1 unit	101	0.363
22	11	17 ... 22	286	50	▶	3RV10 21-4CA10	1	1 unit	101	0.361
25	11	20 ... 25	325	50	▶	3RV10 21-4DA10	1	1 unit	101	0.364

¹⁾ Guide value for 4-pole standard motors at 50 Hz 400 V AC. The actual starting and rated data of the motor to be protected must be considered when selecting the units.

Auxiliary switches can be ordered separately (see "Mountable accessories").



For multi-unit packing and reusable packaging, see "Appendix" --> "Order information".

3RV Motor Starter Protectors up to 100 A

For motor protection

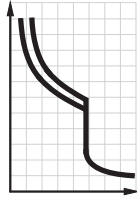
CLASS 10, with transverse auxiliary switch (1 NO + 1 NC)



Rated current I_n A	Suitable for three-phase induction motors ¹⁾ with P kW	Setting range for thermal overload release A	Instantaneous electronic trip unit $I >$ A	Short-circuit breaking capacity at 400 V AC I_{cu} kA	DT	Screw terminals 	PU (UNIT, SET, M)	PS*	PG	Weight per PU approx. kg	
											Order No.
Size S00											
 3RV10 11-0KA15 with integrated transverse auxiliary switch	0.16	0.04	0.11 ... 0.16	2.1	100	▶	3RV10 11-0AA15	1	1 unit	101	0.245
	0.2	0.06	0.14 ... 0.2	2.6	100	▶	3RV10 11-0BA15	1	1 unit	101	0.246
	0.25	0.06	0.18 ... 0.25	3.3	100	▶	3RV10 11-0CA15	1	1 unit	101	0.246
	0.32	0.09	0.22 ... 0.32	4.2	100	▶	3RV10 11-0DA15	1	1 unit	101	0.247
	0.4	0.09	0.28 ... 0.4	5.2	100	▶	3RV10 11-0EA15	1	1 unit	101	0.250
	0.5	0.12	0.35 ... 0.5	6.5	100	▶	3RV10 11-0FA15	1	1 unit	101	0.247
	0.63	0.18	0.45 ... 0.63	8.2	100	▶	3RV10 11-0GA15	1	1 unit	101	0.249
	0.8	0.18	0.55 ... 0.8	10	100	▶	3RV10 11-0HA15	1	1 unit	101	0.250
	1	0.25	0.7 ... 1	13	100	▶	3RV10 11-0JA15	1	1 unit	101	0.249
	1.25	0.37	0.9 ... 1.25	16	100	▶	3RV10 11-0KA15	1	1 unit	101	0.297
	1.6	0.55	1.1 ... 1.6	21	100	▶	3RV10 11-1AA15	1	1 unit	101	0.298
	2	0.75	1.4 ... 2	26	100	▶	3RV10 11-1BA15	1	1 unit	101	0.297
	2.5	0.75	1.8 ... 2.5	33	100	▶	3RV10 11-1CA15	1	1 unit	101	0.298
	3.2	1.1	2.2 ... 3.2	42	100	▶	3RV10 11-1DA15	1	1 unit	101	0.299
	4	1.5	2.8 ... 4	52	100	▶	3RV10 11-1EA15	1	1 unit	101	0.296
	5	1.5	3.5 ... 5	65	100	▶	3RV10 11-1FA15	1	1 unit	101	0.301
	6.3	2.2	4.5 ... 6.3	82	100	▶	3RV10 11-1GA15	1	1 unit	101	0.303
	8	3	5.5 ... 8	104	50	▶	3RV10 11-1HA15	1	1 unit	101	0.304
10	4	7 ... 10	130	50	▶	3RV10 11-1JA15	1	1 unit	101	0.300	
12	5.5	9 ... 12	156	50	▶	3RV10 11-1KA15	1	1 unit	101	0.297	
Size S0											
 3RV10 21-1GA15 with integrated transverse auxiliary switch	0.16	0.04	0.11 ... 0.16	2.1	100	▶	3RV10 21-0AA15	1	1 unit	101	0.300
	0.2	0.06	0.14 ... 0.2	2.6	100	▶	3RV10 21-0BA15	1	1 unit	101	0.304
	0.25	0.06	0.18 ... 0.25	3.3	100	▶	3RV10 21-0CA15	1	1 unit	101	0.302
	0.32	0.09	0.22 ... 0.32	4.2	100	▶	3RV10 21-0DA15	1	1 unit	101	0.303
	0.4	0.09	0.28 ... 0.4	5.2	100	▶	3RV10 21-0EA15	1	1 unit	101	0.303
	0.5	0.12	0.35 ... 0.5	6.5	100	▶	3RV10 21-0FA15	1	1 unit	101	0.304
	0.63	0.18	0.45 ... 0.63	8.2	100	▶	3RV10 21-0GA15	1	1 unit	101	0.305
	0.8	0.18	0.55 ... 0.8	10	100	▶	3RV10 21-0HA15	1	1 unit	101	0.370
	1	0.25	0.7 ... 1	13	100	▶	3RV10 21-0JA15	1	1 unit	101	0.368
	1.25	0.37	0.9 ... 1.25	16	100	▶	3RV10 21-0KA15	1	1 unit	101	0.369
	1.6	0.55	1.1 ... 1.6	21	100	▶	3RV10 21-1AA15	1	1 unit	101	0.371
	2	0.75	1.4 ... 2	26	100	▶	3RV10 21-1BA15	1	1 unit	101	0.371
	2.5	0.75	1.8 ... 2.5	33	100	▶	3RV10 21-1CA15	1	1 unit	101	0.372
	3.2	1.1	2.2 ... 3.2	42	100	▶	3RV10 21-1DA15	1	1 unit	101	0.375
	4	1.5	2.8 ... 4	52	100	▶	3RV10 21-1EA15	1	1 unit	101	0.370
	5	1.5	3.5 ... 5	65	100	▶	3RV10 21-1FA15	1	1 unit	101	0.376
	6.3	2.2	4.5 ... 6.3	82	100	▶	3RV10 21-1GA15	1	1 unit	101	0.374
	8	3	5.5 ... 8	104	100	▶	3RV10 21-1HA15	1	1 unit	101	0.374
10	4	7 ... 10	130	100	▶	3RV10 21-1JA15	1	1 unit	101	0.375	
12.5	5.5	9 ... 12.5	163	100	▶	3RV10 21-1KA15	1	1 unit	101	0.374	
16	7.5	11 ... 16	208	50	▶	3RV10 21-4AA15	1	1 unit	101	0.382	
20	7.5	14 ... 20	260	50	▶	3RV10 21-4BA15	1	1 unit	101	0.376	
22	11	17 ... 22	286	50	▶	3RV10 21-4CA15	1	1 unit	101	0.378	
25	11	20 ... 25	325	50	▶	3RV10 21-4DA15	1	1 unit	101	0.382	

¹⁾ Guide value for 4-pole standard motors at 50 Hz 400 V AC. The actual starting and rated data of the motor to be protected must be considered when selecting the units.



Auxiliary switches can be ordered separately (see "Mountable accessories").

For multi-unit packing and reusable packaging, see "Appendix" --> "Order information".

3RV Motor Starter Protectors up to 100 A

For motor protection

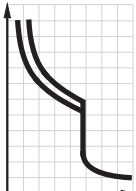
CLASS 10, without auxiliary switches



	Rated current	Suitable for three-phase induction motors ¹⁾ with P	Setting range for thermal overload release	Instantaneous electronic trip unit	Short-circuit breaking capacity at 400 V AC	DT	Cage Clamp terminals 	PU (UNIT, SET, M)	PS*	PG	Weight per PU approx.	
	I_n	kW	A	A	A	kA		Order No.	Price per PU		kg	
Size S00												
	0.16	0.04	0.11 ... 0.16	2.1	100	▶	3RV10 11-0AA20		1	1 unit	101	0.233
	0.2	0.06	0.14 ... 0.2	2.6	100	▶	3RV10 11-0BA20		1	1 unit	101	0.234
	0.25	0.06	0.18 ... 0.25	3.3	100	▶	3RV10 11-0CA20		1	1 unit	101	0.234
	0.32	0.09	0.22 ... 0.32	4.2	100	▶	3RV10 11-0DA20		1	1 unit	101	0.234
	0.4	0.09	0.28 ... 0.4	5.2	100	▶	3RV10 11-0EA20		1	1 unit	101	0.236
	0.5	0.12	0.35 ... 0.5	6.5	100	▶	3RV10 11-0FA20		1	1 unit	101	0.232
	0.63	0.18	0.45 ... 0.63	8.2	100	▶	3RV10 11-0GA20		1	1 unit	101	0.234
	0.8	0.18	0.55 ... 0.8	10	100	▶	3RV10 11-0HA20		1	1 unit	101	0.237
	1	0.25	0.7 ... 1	13	100	▶	3RV10 11-0JA20		1	1 unit	101	0.235
	1.25	0.37	0.9 ... 1.25	16	100	▶	3RV10 11-0KA20		1	1 unit	101	0.281
	1.6	0.55	1.1 ... 1.6	21	100	▶	3RV10 11-1AA20		1	1 unit	101	0.283
	2	0.75	1.4 ... 2	26	100	▶	3RV10 11-1BA20		1	1 unit	101	0.282
2.5	0.75	1.8 ... 2.5	33	100	▶	3RV10 11-1CA20		1	1 unit	101	0.284	
3.2	1.1	2.2 ... 3.2	42	100	▶	3RV10 11-1DA20		1	1 unit	101	0.285	
4	1.5	2.8 ... 4	52	100	▶	3RV10 11-1EA20		1	1 unit	101	0.284	
5	1.5	3.5 ... 5	65	100	▶	3RV10 11-1FA20		1	1 unit	101	0.286	
6.3	2.2	4.5 ... 6.3	82	100	▶	3RV10 11-1GA20		1	1 unit	101	0.288	
8	3	5.5 ... 8	104	50	▶	3RV10 11-1HA20		1	1 unit	101	0.290	
10	4	7 ... 10	130	50	▶	3RV10 11-1JA20		1	1 unit	101	0.286	
12	5.5	9 ... 12	156	50	▶	3RV10 11-1KA20		1	1 unit	101	0.282	

¹⁾ Guide value for 4-pole standard motors at 50 Hz 400 V AC. The actual starting and rated data of the motor to be protected must be considered when selecting the units.

Auxiliary switches can be ordered separately (see "Mountable accessories").

For multi-unit packing and reusable packaging, see "Appendix" -> "Order information".

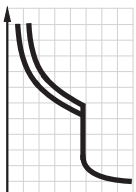
CLASS 10, with transverse auxiliary switch (1 NO + 1 NC)

	Rated current	Suitable for three-phase induction motors ¹⁾ with P	Setting range for thermal overload release	Instantaneous electronic trip unit	Short-circuit breaking capacity at 400 V AC	DT	Cage Clamp terminals 	PU (UNIT, SET, M)	PS*	PG	Weight per PU approx.	
	I_n	kW	A	A	A	kA		Order No.	Price per PU		kg	
Size S00												
	0.16	0.04	0.11 ... 0.16	2.1	100	B	3RV10 11-0AA25		1	1 unit	101	0.245
	0.2	0.06	0.14 ... 0.2	2.6	100	B	3RV10 11-0BA25		1	1 unit	101	0.245
	0.25	0.06	0.18 ... 0.25	3.3	100	B	3RV10 11-0CA25		1	1 unit	101	0.246
	0.32	0.09	0.22 ... 0.32	4.2	100	B	3RV10 11-0DA25		1	1 unit	101	0.246
	0.4	0.09	0.28 ... 0.4	5.2	100	B	3RV10 11-0EA25		1	1 unit	101	0.250
	0.5	0.12	0.35 ... 0.5	6.5	100	B	3RV10 11-0FA25		1	1 unit	101	0.247
	0.63	0.18	0.45 ... 0.63	8.2	100	B	3RV10 11-0GA25		1	1 unit	101	0.252
	0.8	0.18	0.55 ... 0.8	10	100	B	3RV10 11-0HA25		1	1 unit	101	0.250
	1	0.25	0.7 ... 1	13	100	B	3RV10 11-0JA25		1	1 unit	101	0.249
	1.25	0.37	0.9 ... 1.25	16	100	B	3RV10 11-0KA25		1	1 unit	101	0.297
	1.6	0.55	1.1 ... 1.6	21	100	B	3RV10 11-1AA25		1	1 unit	101	0.298
	2	0.75	1.4 ... 2	26	100	B	3RV10 11-1BA25		1	1 unit	101	0.297
2.5	0.75	1.8 ... 2.5	33	100	B	3RV10 11-1CA25		1	1 unit	101	0.298	
3.2	1.1	2.2 ... 3.2	42	100	B	3RV10 11-1DA25		1	1 unit	101	0.300	
4	1.5	2.8 ... 4	52	100	B	3RV10 11-1EA25		1	1 unit	101	0.298	
5	1.5	3.5 ... 5	65	100	B	3RV10 11-1FA25		1	1 unit	101	0.303	
6.3	2.2	4.5 ... 6.3	82	100	B	3RV10 11-1GA25		1	1 unit	101	0.303	
8	3	5.5 ... 8	104	50	B	3RV10 11-1HA25		1	1 unit	101	0.304	
10	4	7 ... 10	130	50	B	3RV10 11-1JA25		1	1 unit	101	0.300	
12	5.5	9 ... 12	156	50	B	3RV10 11-1KA25		1	1 unit	101	0.298	

¹⁾ Guide value for 4-pole standard motors at 50 Hz 400 V AC. The actual starting and rated data of the motor to be protected must be considered when selecting the units.

Auxiliary switches can be ordered separately (see "Mountable accessories").

For multi-unit packing and reusable packaging, see "Appendix" -> "Order information".

3RV Motor Starter Protectors up to 100 A

For motor protection

CLASS 10, without auxiliary switches

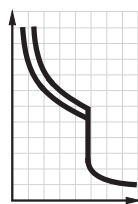

Rated current	Suitable for three-phase induction motors ¹⁾ with P	Setting range for thermal overload release	Instantaneous electronic trip unit	Short-circuit breaking capacity at 400 V AC	DT	Screw terminals	PU (UNIT, SET, M)	PS*	PG	Weight per PU approx.
I_n				I_{cu}			Order No.	Price per PU		kg
A	kW	A	A	kA						

Size S2



3RV10 31-4HA10

16	7.5	11 ... 16	208	50	▶	3RV10 31-4AA10		1	1 unit	101	1.046
20	7.5	14 ... 20	260	50	▶	3RV10 31-4BA10		1	1 unit	101	1.043
25	11	18 ... 25	325	50	▶	3RV10 31-4DA10		1	1 unit	101	1.031
32	15	22 ... 32	416	50	▶	3RV10 31-4EA10		1	1 unit	101	1.028
40	18.5	28 ... 40	520	50	▶	3RV10 31-4FA10		1	1 unit	101	1.047
45	22	36 ... 45	585	50	▶	3RV10 31-4GA10		1	1 unit	101	1.039
50	22	40 ... 50	650	50	▶	3RV10 31-4HA10		1	1 unit	101	1.027

Size S3



3RV10 41-4LA10

40	18.5	28 ... 40	520	50	▶	3RV10 41-4FA10		1	1 unit	101	2.219
50	22	36 ... 50	650	50	▶	3RV10 41-4HA10		1	1 unit	101	2.240
63	30	45 ... 63	819	50	▶	3RV10 41-4JA10		1	1 unit	101	2.247
75	37	57 ... 75	975	50	▶	3RV10 41-4KA10		1	1 unit	101	2.253
90	45	70 ... 90	1170	50	▶	3RV10 41-4LA10		1	1 unit	101	2.280
100	45	80 ... 100	1235	50	▶	3RV10 41-4MA10		1	1 unit	101	2.295

Size S3, with increased switching capacity



3RV10 42-4JA10

16	7.5	11 ... 16	208	100	▶	3RV10 42-4AA10		1	1 unit	101	2.174
20	7.5	14 ... 20	260	100	▶	3RV10 42-4BA10		1	1 unit	101	2.185
25	11	18 ... 25	325	100	▶	3RV10 42-4DA10		1	1 unit	101	2.211
32	15	22 ... 32	416	100	▶	3RV10 42-4EA10		1	1 unit	101	2.222
40	18.5	28 ... 40	520	100	▶	3RV10 42-4FA10		1	1 unit	101	2.203
50	22	36 ... 50	650	100	▶	3RV10 42-4HA10		1	1 unit	101	2.230
63	30	45 ... 63	819	100	▶	3RV10 42-4JA10		1	1 unit	101	2.255
75	37	57 ... 75	975	100	▶	3RV10 42-4KA10		1	1 unit	101	2.266
90	45	70 ... 90	1170	100	▶	3RV10 42-4LA10		1	1 unit	101	2.268
100	45	80 ... 100	1235	100	▶	3RV10 42-4MA10		1	1 unit	101	2.275

CLASS 20, without auxiliary switches

Size S2



3RV10 31-4AB10

16	7.5	11 ... 16	208	50	A	3RV10 31-4AB10		1	1 unit	101	1.067
20	7.5	14 ... 20	260	50	A	3RV10 31-4BB10		1	1 unit	101	1.071
25	11	18 ... 25	325	50	A	3RV10 31-4DB10		1	1 unit	101	1.054
32	15	22 ... 32	416	50	A	3RV10 31-4EB10		1	1 unit	101	1.067
40	18.5	28 ... 40	520	50	A	3RV10 31-4FB10		1	1 unit	101	1.076
45	22	36 ... 45	585	50	A	3RV10 31-4GB10		1	1 unit	101	1.073
50	22	40 ... 50	650	50	A	3RV10 31-4HB10		1	1 unit	101	1.071

Size S3, with increased switching capacity



3RV10 42-4KB10

40	18.5	28 ... 40	520	100	A	3RV10 42-4FB10		1	1 unit	101	2.222
50	22	36 ... 50	650	100	A	3RV10 42-4HB10		1	1 unit	101	2.265
63	30	45 ... 63	819	100	A	3RV10 42-4JB10		1	1 unit	101	2.278
75	37	57 ... 75	975	100	A	3RV10 42-4KB10		1	1 unit	101	2.268
90	45	70 ... 90	1170	100	A	3RV10 42-4LB10		1	1 unit	101	2.313
100	45	80 ... 100	1235	100	A	3RV10 42-4MB10		1	1 unit	101	2.322

¹⁾ Guide value for 4-pole standard motors at 50 Hz 400 V AC. The actual starting and rated data of the motor to be protected must be considered when selecting the units.

Auxiliary switches and other accessories can be ordered separately (see "Mountable accessories").

For multi-unit packing and reusable packaging, see "Appendix" -> "Order information".





* You can order this quantity or a multiple thereof.

3RV Motor Starter Protectors up to 100 A

For motor protection with overload relay function

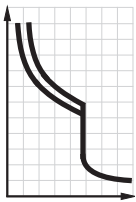
Selection and ordering data

CLASS 10, with overload relay function (automatic RESET), without auxiliary switches

	Rated current	Suitable for three-phase induction motors ¹⁾ with P	Setting range for thermal overload release	Instantaneous electronic trip unit	Short-circuit breaking capacity at 400 V AC	DT	Screw terminals		PU (UNIT, SET, M)	PS*	PG	Weight per PU approx.
	I_n	kW	A	A	A	kA		Order No.	Price per PU			kg
Size S0²⁾												
 3RV11 21-0KA10	0.16	0.04	0.11 ... 0.16	2.1	100	A	3RV11 21-0AA10		1	1 unit	101	0.354
	0.2	0.06	0.14 ... 0.2	2.6	100	A	3RV11 21-0BA10		1	1 unit	101	0.358
	0.25	0.06	0.18 ... 0.25	3.3	100	A	3RV11 21-0CA10		1	1 unit	101	0.352
	0.32	0.09	0.22 ... 0.32	4.2	100	A	3RV11 21-0DA10		1	1 unit	101	0.352
	0.4	0.09	0.28 ... 0.4	5.2	100	A	3RV11 21-0EA10		1	1 unit	101	0.355
	0.5	0.12	0.35 ... 0.5	6.5	100	A	3RV11 21-0FA10		1	1 unit	101	0.356
	0.63	0.18	0.45 ... 0.63	8.2	100	A	3RV11 21-0GA10		1	1 unit	101	0.358
	0.8	0.18	0.55 ... 0.8	10	100	A	3RV11 21-0HA10		1	1 unit	101	0.421
	1	0.25	0.7 ... 1	13	100	A	3RV11 21-0JA10		1	1 unit	101	0.416
	1.25	0.37	0.9 ... 1.25	16	100	A	3RV11 21-0KA10		1	1 unit	101	0.426
	1.6	0.55	1.1 ... 1.6	21	100	A	3RV11 21-1AA10		1	1 unit	101	0.422
	2	0.75	1.4 ... 2	26	100	A	3RV11 21-1BA10		1	1 unit	101	0.427
	2.5	0.75	1.8 ... 2.5	33	100	A	3RV11 21-1CA10		1	1 unit	101	0.422
	3.2	1.1	2.2 ... 3.2	42	100	A	3RV11 21-1DA10		1	1 unit	101	0.428
	4	1.5	2.8 ... 4	52	100	A	3RV11 21-1EA10		1	1 unit	101	0.420
	5	1.5	3.5 ... 5	65	100	A	3RV11 21-1FA10		1	1 unit	101	0.429
6.3	2.2	4.5 ... 6.3	82	100	A	3RV11 21-1GA10		1	1 unit	101	0.426	
8	3	5.5 ... 8	104	100	A	3RV11 21-1HA10		1	1 unit	101	0.425	
10	4	7 ... 10	130	100	A	3RV11 21-1JA10		1	1 unit	101	0.428	
12.5	5.5	9 ... 12.5	163	100	A	3RV11 21-1KA10		1	1 unit	101	0.426	
16	7.5	11 ... 16	208	50	A	3RV11 21-4AA10		1	1 unit	101	0.436	
20	7.5	14 ... 20	260	50	A	3RV11 21-4BA10		1	1 unit	101	0.430	
22	11	17 ... 22	286	50	A	3RV11 21-4CA10		1	1 unit	101	0.427	
25	11	20 ... 25	325	50	A	3RV11 21-4DA10		1	1 unit	101	0.432	
Size S2²⁾												
 3RV11 31-4EA10	16	7.5	11 ... 16	208	50	A	3RV11 31-4AA10		1	1 unit	101	1.123
	20	7.5	14 ... 20	260	50	A	3RV11 31-4BA10		1	1 unit	101	1.109
	25	11	18 ... 25	325	50	A	3RV11 31-4DA10		1	1 unit	101	1.114
	32	15	22 ... 32	416	50	A	3RV11 31-4EA10		1	1 unit	101	1.111
	40	18.5	28 ... 40	520	50	A	3RV11 31-4FA10		1	1 unit	101	1.123
	45	22	36 ... 45	585	50	A	3RV11 31-4GA10		1	1 unit	101	1.101
	50	22	40 ... 50	650	50	A	3RV11 31-4HA10		1	1 unit	101	1.106
	Size S3, with increased switching capacity²⁾											
 3RV11 42-4AA10	16	7.5	11 ... 16	208	100	A	3RV11 42-4AA10		1	1 unit	101	2.247
	20	7.5	14 ... 20	260	100	A	3RV11 42-4BA10		1	1 unit	101	2.255
	25	11	18 ... 25	325	100	A	3RV11 42-4DA10		1	1 unit	101	2.284
	32	15	22 ... 32	416	100	A	3RV11 42-4EA10		1	1 unit	101	2.295
	40	18.5	28 ... 40	520	100	A	3RV11 42-4FA10		1	1 unit	101	2.288
	50	22	36 ... 50	650	100	A	3RV11 42-4HA10		1	1 unit	101	2.320
	63	30	45 ... 63	819	100	A	3RV11 42-4JA10		1	1 unit	101	2.333
	75	37	57 ... 75	975	100	A	3RV11 42-4KA10		1	1 unit	101	2.368
	90	45	70 ... 90	1170	100	A	3RV11 42-4LA10		1	1 unit	101	2.353
	100	45	80 ... 100	1235	100	A	3RV11 42-4MA10		1	1 unit	101	2.346

¹⁾ Guide value for 4-pole standard motors at 50 Hz 400 V AC. The actual starting and rated data of the motor to be protected must be considered when selecting the units.

²⁾ Accessories for mounting on the right (for sizes S0 to S3) and 3RV19 15 three-phase busbars (for size S0) cannot be used.

Auxiliary switches can be ordered separately (see "Mountable accessories").

3RV Motor Starter Protectors up to 100 A

For starter combinations

Selection and ordering data

Without auxiliary switches

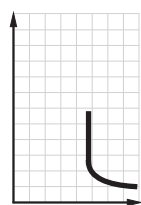

Rated current	Suitable for three-phase induction motors ¹⁾ with P	Thermal overload release ²⁾	Instantaneous electronic trip unit	Short-circuit breaking capacity at 400 V AC	DT	Screw terminals	⊕	PU (UNIT, SET, M)	PS*	PG	Weight per PU approx.
I_n			$I >$	I_{cu}		Order No.		Price per PU			kg
A	kW	A	A	kA							

Size S0



3RV13 21-0AC10

0.16	0.04	Without	2.1	100	A	3RV13 21-0AC10		1	1 unit	101	0.282
0.2	0.06	Without	2.6	100	A	3RV13 21-0BC10		1	1 unit	101	0.284
0.25	0.06	Without	3.3	100	A	3RV13 21-0CC10		1	1 unit	101	0.285
0.32	0.09	Without	4.2	100	A	3RV13 21-0DC10		1	1 unit	101	0.282
0.4	0.09	Without	5.2	100	A	3RV13 21-0EC10		1	1 unit	101	0.286
0.5	0.12	Without	6.5	100	A	3RV13 21-0FC10		1	1 unit	101	0.283
0.63	0.18	Without	8.2	100	A	3RV13 21-0GC10		1	1 unit	101	0.348
0.8	0.18	Without	10	100	A	3RV13 21-0HC10		1	1 unit	101	0.283
1	0.25	Without	13	100	A	3RV13 21-0JC10		1	1 unit	101	0.345
1.25	0.37	Without	16	100	A	3RV13 21-0KC10		1	1 unit	101	0.351
1.6	0.55	Without	21	100	A	3RV13 21-1AC10		1	1 unit	101	0.352
2	0.75	Without	26	100	A	3RV13 21-1BC10		1	1 unit	101	0.352
2.5	0.75	Without	33	100	A	3RV13 21-1CC10		1	1 unit	101	0.352
3.2	1.1	Without	42	100	A	3RV13 21-1DC10		1	1 unit	101	0.353
4	1.5	Without	52	100	A	3RV13 21-1EC10		1	1 unit	101	0.349
5	1.5	Without	65	100	A	3RV13 21-1FC10		1	1 unit	101	0.354
6.3	2.2	Without	82	100	A	3RV13 21-1GC10		1	1 unit	101	0.355
8	3	Without	104	100	A	3RV13 21-1HC10		1	1 unit	101	0.354
10	4	Without	130	100	A	3RV13 21-1JC10		1	1 unit	101	0.357
12.5	5.5	Without	163	100	A	3RV13 21-1KC10		1	1 unit	101	0.354
16	7.5	Without	208	50	A	3RV13 21-4AC10		1	1 unit	101	0.362
20	7.5	Without	260	50	A	3RV13 21-4BC10		1	1 unit	101	0.357
22	11	Without	286	50	A	3RV13 21-4CC10		1	1 unit	101	0.358
25	11	Without	325	50	A	3RV13 21-4DC10		1	1 unit	101	0.359

Size S2



3RV13 31-4AC10

16	7.5	Without	208	50	A	3RV13 31-4AC10		1	1 unit	101	1.038
20	7.5	Without	260	50	A	3RV13 31-4BC10		1	1 unit	101	1.037
25	11	Without	325	50	A	3RV13 31-4DC10		1	1 unit	101	1.014
32	15	Without	416	50	A	3RV13 31-4EC10		1	1 unit	101	1.018
40	18.5	Without	520	50	A	3RV13 31-4FC10		1	1 unit	101	1.033
45	22	Without	585	50	A	3RV13 31-4GC10		1	1 unit	101	1.040
50	22	Without	650	50	A	3RV13 31-4HC10		1	1 unit	101	1.019

Size S3



3RV13 41-4JC10

40	18.5	Without	520	50	A	3RV13 41-4FC10		1	1 unit	101	2.197
50	22	Without	650	50	A	3RV13 41-4HC10		1	1 unit	101	2.227
63	30	Without	819	50	A	3RV13 41-4JC10		1	1 unit	101	2.244
75	37	Without	975	50	A	3RV13 41-4KC10		1	1 unit	101	2.247
90	45	Without	1170	50	A	3RV13 41-4LC10		1	1 unit	101	2.269
100	45	Without	1235	50	A	3RV13 41-4MC10		1	1 unit	101	2.292

Size S3, with increased switching capacity



3RV13 42-4JC10

16	7.5	Without	208	100	A	3RV13 42-4AC10		1	1 unit	101	2.175
20	7.5	Without	260	100	A	3RV13 42-4BC10		1	1 unit	101	2.188
25	11	Without	325	100	A	3RV13 42-4DC10		1	1 unit	101	2.219
32	15	Without	416	100	A	3RV13 42-4EC10		1	1 unit	101	2.208
40	18.5	Without	520	100	A	3RV13 42-4FC10		1	1 unit	101	2.218
50	22	Without	650	100	A	3RV13 42-4HC10		1	1 unit	101	2.218
63	30	Without	819	100	A	3RV13 42-4JC10		1	1 unit	101	2.248
75	37	Without	975	100	A	3RV13 42-4KC10		1	1 unit	101	2.278
90	45	Without	1170	100	A	3RV13 42-4LC10		1	1 unit	101	2.266
100	45	Without	1235	100	A	3RV13 42-4MC10		1	1 unit	101	2.293

¹⁾ Guide value for 4-pole standard motors at 50 Hz 400 V AC. The actual starting and rated data of the motor to be protected must be considered when selecting the units.

²⁾ For overload protection of the motors, appropriate overload relays must be used.

Auxiliary switches can be ordered separately (see "Mountable accessories").

For multi-unit packing and reusable packaging, see "Appendix" -> "Order information".

* You can order this quantity or a multiple thereof.





3RV Motor Starter Protectors up to 100 A

For transformer protection

Selection and ordering data

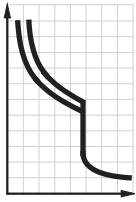
CLASS 10, without auxiliary switches

Motor starter protectors for the protection of transformers with high inrush current

	Rated current	Setting range for thermal overload release	Instantaneous electronic trip unit	Short-circuit breaking capacity at 400 V AC	DT	Screw terminals 	PU (UNIT, SET, M)	PS*	PG	Weight per PU approx.	
	I_n A	 A	$I >$ A	I_{cu} kA		Order No.	Price per PU			kg	
Size S0											
	0.16	0.11 ... 0.16	3.3	100	▶	3RV14 21-0AA10		1	1 unit	101	0.286
	0.2	0.14 ... 0.2	4.2	100	▶	3RV14 21-0BA10		1	1 unit	101	0.287
	0.25	0.18 ... 0.25	5.2	100	▶	3RV14 21-0CA10		1	1 unit	101	0.286
	0.32	0.22 ... 0.32	6.5	100	▶	3RV14 21-0DA10		1	1 unit	101	0.288
	0.4	0.28 ... 0.4	8.2	100	▶	3RV14 21-0EA10		1	1 unit	101	0.287
	0.5	0.35 ... 0.5	10	100	▶	3RV14 21-0FA10		1	1 unit	101	0.286
	0.63	0.45 ... 0.63	13	100	▶	3RV14 21-0GA10		1	1 unit	101	0.290
	0.8	0.55 ... 0.8	16	100	▶	3RV14 21-0HA10		1	1 unit	101	0.290
	1	0.7 ... 1	21	100	▶	3RV14 21-0JA10		1	1 unit	101	0.353
	1.25	0.9 ... 1.25	26	100	▶	3RV14 21-0KA10		1	1 unit	101	0.354
	1.6	1.1 ... 1.6	33	100	▶	3RV14 21-1AA10		1	1 unit	101	0.353
	2	1.4 ... 2	42	100	▶	3RV14 21-1BA10		1	1 unit	101	0.358
	2.5	1.8 ... 2.5	52	100	▶	3RV14 21-1CA10		1	1 unit	101	0.354
	3.2	2.2 ... 3.2	65	100	▶	3RV14 21-1DA10		1	1 unit	101	0.358
	4	2.8 ... 4	82	100	▶	3RV14 21-1EA10		1	1 unit	101	0.354
	5	3.5 ... 5	104	100	▶	3RV14 21-1FA10		1	1 unit	101	0.357
	6.3	4.5 ... 6.3	130	100	▶	3RV14 21-1GA10		1	1 unit	101	0.356
	8	5.5 ... 8	163	100	▶	3RV14 21-1HA10		1	1 unit	101	0.358
	10	7 ... 10	208	100	▶	3RV14 21-1JA10		1	1 unit	101	0.362
12.5	9 ... 12.5	260	100	▶	3RV14 21-1KA10		1	1 unit	101	0.360	
16	11 ... 16	286	50	▶	3RV14 21-4AA10		1	1 unit	101	0.365	
20	14 ... 20	325	50	▶	3RV14 21-4BA10		1	1 unit	101	0.365	
Size S2											
	16	11 ... 16	325	50	▶	3RV14 31-4AA10		1	1 unit	101	1.029
	20	14 ... 20	416	50	▶	3RV14 31-4BA10		1	1 unit	101	1.034
	25	18 ... 25	520	50	▶	3RV14 31-4DA10		1	1 unit	101	1.038
	32	22 ... 32	660	50	▶	3RV14 31-4EA10		1	1 unit	101	1.029
	40	28 ... 40	836	50	▶	3RV14 31-4FA10		1	1 unit	101	1.039

3RV14 31-4DA10

Auxiliary switches can be ordered separately (see "Mountable accessories").

For multi-unit packing and reusable packaging, see "Appendix" --> "Order information".

3RV Motor Starter Protectors up to 100 A

For fuse monitoring

Selection and ordering data

Without auxiliary switches

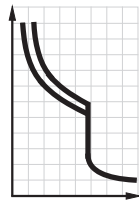

Rated current	Thermal overload release	Instantaneous electronic trip unit	Short-circuit breaking capacity at 400 V AC	DT	Screw terminals	PU (UNIT, SET, M)	PS*	PG	Weight per PU approx.
I_n		$I >$	I_{cu}		Order No.	Price per PU			kg
A	A	A	kA						

Size S00



3RV16 11-0BD10

0.2	0.2	1.2	100	▶	3RV16 11-0BD10		1	1 unit	101	0.289
-----	-----	-----	-----	---	-----------------------	--	---	--------	-----	-------

Note:

The auxiliary switch required for signaling must be ordered separately.

For multi-unit packing and reusable packaging, see "Appendix" --> "Order information".

Accessories

Version	Contacts	DT	Screw terminals	PU (UNIT, SET, M)	PS*	PG	Weight per PU approx.
			Order No.	Price per PU			kg

Mountable auxiliary switches (essential accessories)



3RV19 01-1E

Transverse auxiliary switches With screw terminals, mountable on front	1 NO + 1 NC	▶	3RV19 01-1E		1	1 unit	101	0.018
---	-------------	---	--------------------	--	---	--------	-----	-------



3RV19 01-1A

Lateral auxiliary switches With screw terminals, mountable on the left	1 NO + 1 NC	▶	3RV19 01-1A		1	1 unit	101	0.045
---	-------------	---	--------------------	--	---	--------	-----	-------

Additional auxiliary switches and other accessories see "Mountable accessories".





3RV Circuit Breakers up to 100 A

For system protection
according to UL 489/CSA C22.2 No. 5-02

Selection and ordering data

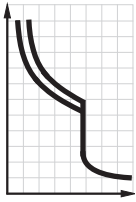
Without auxiliary switches

Circuit breakers for system protection and non-motor loads according to UL/CSA

	Rated current 1)	Thermal overload release (non- adjust- able)	Instanta- neous overcur- rent trip unit	Short-circuit breaking capacity at 480 Y/277 V AC ²⁾ 480 V AC		DT	Screw terminals	PU (UNIT, SET, M)	PS*	PG	Weight per PU approx.	
	I_n		$I >$	I_{bc}	I_{bc}		Order No.	Price per PU				kg
A	A	A	kA	kA								
Size S0												
	0.16	0.16	2.1	50	--	C	3RV17 21-0AD10		1	1 unit	101	0.460
	0.2	0.2	2.6	50	--	C	3RV17 21-0BD10		1	1 unit	101	0.460
	0.25	0.25	3.3	50	--	C	3RV17 21-0CD10		1	1 unit	101	0.460
	0.32	0.32	4.2	50	--	C	3RV17 21-0DD10		1	1 unit	101	0.460
	0.4	0.4	5.2	50	--	C	3RV17 21-0ED10		1	1 unit	101	0.460
	0.5	0.5	6.5	50	--	C	3RV17 21-0FD10		1	1 unit	101	0.460
	0.63	0.63	8.2	50	--	C	3RV17 21-0GD10		1	1 unit	101	0.460
	0.8	0.8	10	50	--	C	3RV17 21-0HD10		1	1 unit	101	0.530
	1	1	13	50	--	C	3RV17 21-0JD10		1	1 unit	101	0.530
	1.25	1.25	16	50	--	C	3RV17 21-0KD10		1	1 unit	101	0.530
	1.6	1.6	21	50	--	C	3RV17 21-1AD10		1	1 unit	101	0.530
	2	2	26	50	--	C	3RV17 21-1BD10		1	1 unit	101	0.530
	2.5	2.5	33	50	--	C	3RV17 21-1CD10		1	1 unit	101	0.530
	3.2	3.2	42	50	--	C	3RV17 21-1DD10		1	1 unit	101	0.530
	4	4	52	50	--	C	3RV17 21-1ED10		1	1 unit	101	0.530
	5	5	65	50	--	C	3RV17 21-1FD10		1	1 unit	101	0.530
6.3	6.3	82	50	--	C	3RV17 21-1GD10		1	1 unit	101	0.530	
8	8	104	50	--	C	3RV17 21-1HD10		1	1 unit	101	0.530	
10	10	130	50	--	C	3RV17 21-1JD10		1	1 unit	101	0.530	
12.5	12.5	163	50	--	C	3RV17 21-1KD10		1	1 unit	101	0.530	
15	15	208	50	--	C	3RV17 21-4AD10		1	1 unit	101	0.530	
20	20	260	50	--	C	3RV17 21-4BD10		1	1 unit	101	0.530	
22	22	286	50	--	C	3RV17 21-4CD10		1	1 unit	101	0.530	
Size S3												
	10	10	150	65	65	B	3RV17 42-5AD10		1	1 unit	101	0.460
	15	15	225	65	65	B	3RV17 42-5BD10		1	1 unit	101	0.460
	20	20	260	65	65	B	3RV17 42-5CD10		1	1 unit	101	0.460
	25	25	325	65	65	B	3RV17 42-5DD10		1	1 unit	101	0.460
	30	30	390	65	65	B	3RV17 42-5ED10		1	1 unit	101	0.460
	35	35	455	65	--	B	3RV17 42-5FD10		1	1 unit	101	0.460
	40	40	520	65	--	B	3RV17 42-5GD10		1	1 unit	101	0.460
	45	45	585	65	--	B	3RV17 42-5HD10		1	1 unit	101	0.460
	50	50	650	65	--	B	3RV17 42-5JD10		1	1 unit	101	0.460
	60	60	780	65	--	B	3RV17 42-5LD10		1	1 unit	101	0.460
	70	70	910	65	--	B	3RV17 42-5QD10		1	1 unit	101	0.460

1) 100 % rated value acc. to UL 489 and IEC 60947-2 (100 % rated breaker).

2) For values for 600 Y/347 V AC see Technical Information LV 1 T, Chapter 5, "3RV Motor Starter Protectors/Circuit Breakers up to 100 A" --> "General data" --> "Technical specifications" --> "Permissible rated data of devices approved for North America (UL/CSA)" --> "3RV17 and 3RV18 motor starter protectors as circuit breakers".

Transverse auxiliary switches must not be mounted,
lateral auxiliary switches can be ordered separately
(see "Mountable accessories").

3RV Circuit Breakers up to 100 A

For transformer protection
according to UL 489/CSA C22.2 No. 5-02

Selection and ordering data

Without auxiliary switches

Circuit breakers for system and transformer protection according to UL/CSA,
specially designed for transformers with high inrush current

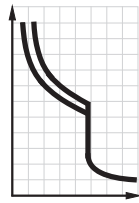

Rated current ¹⁾	Thermal overload release (non-adjustable)	Instantaneous electronic trip unit	Short-circuit breaking capacity at 480 Y/277 V AC ²⁾	DT	Screw terminals	PU (UNIT, SET, M)	PS*	PG	Weight per PU approx.
I_n		$I >$	I_{bc}		Order No.	Price per PU			kg
A	A	A	kA						

Size S0



3RV18 21-0AD10

0.16	0.16	3.3	50	C	3RV18 21-0AD10		1	1 unit	101	0.450
0.2	0.2	4.2	50	C	3RV18 21-0BD10		1	1 unit	101	0.450
0.25	0.25	5.2	50	C	3RV18 21-0CD10		1	1 unit	101	0.450
0.32	0.32	6.5	50	C	3RV18 21-0DD10		1	1 unit	101	0.450
0.4	0.4	8.2	50	C	3RV18 21-0ED10		1	1 unit	101	0.450
0.5	0.5	10	50	C	3RV18 21-0FD10		1	1 unit	101	0.450
0.63	0.63	13	50	C	3RV18 21-0GD10		1	1 unit	101	0.450
0.8	0.8	16	50	C	3RV18 21-0HD10		1	1 unit	101	0.450
1	1	21	50	C	3RV18 21-0JD10		1	1 unit	101	0.520
1.25	1.25	26	50	C	3RV18 21-0KD10		1	1 unit	101	0.520
1.6	1.6	33	50	C	3RV18 21-1AD10		1	1 unit	101	0.520
2	2	42	50	C	3RV18 21-1BD10		1	1 unit	101	0.520
2.5	2.5	52	50	C	3RV18 21-1CD10		1	1 unit	101	0.520
3.2	3.2	65	50	C	3RV18 21-1DD10		1	1 unit	101	0.520
4	4	82	50	C	3RV18 21-1ED10		1	1 unit	101	0.520
5	5	104	50	C	3RV18 21-1FD10		1	1 unit	101	0.520
6.3	6.3	130	50	C	3RV18 21-1GD10		1	1 unit	101	0.520
8	8	163	50	C	3RV18 21-1HD10		1	1 unit	101	0.520
10	10	208	50	C	3RV18 21-1JD10		1	1 unit	101	0.520
12.5	12.5	260	50	C	3RV18 21-1KD10		1	1 unit	101	0.520
15	15	286	50	C	3RV18 21-4AD10		1	1 unit	101	0.520
20	20	325	50	C	3RV18 21-4BD10		1	1 unit	101	0.520

¹⁾ 100 % rated value acc. to UL 489 and IEC 60947-2 (100 % rated breaker).

²⁾ For values for 600 Y/347 V AC see Technical Information LV 1 T, Chapter 5, "3RV Motor Starter Protectors/Circuit Breakers up to 100 A" --> "General data" --> "Technical specifications" --> "Permissible rated data of devices approved for North America (UL/CSA)" --> "3RV17 and 3RV18 motor starter protectors as circuit breakers".

Transverse auxiliary switches must not be mounted,
lateral auxiliary switches can be ordered separately
(see "Mountable accessories").

3RV Motor Starter Protectors up to 100 A

For distance protection

Selection and ordering data

Voltage transformer circuit breakers with auxiliary switches (1 W)



Rated current	Thermal overload release	Instantaneous electronic trip units	Auxiliary switch integrated in the motor starter protector, transverse	Short-circuit breaking capacity at 400 V AC	DT	Screw terminals	PU (UNIT, SET, M)	PS*	PG	Weight per PU approx.
I_n				I_{cu}						
A	A	A		kA		Order No.	Price per PU			kg

Size S00



3RV16 11-1.G14

1.4	1.4	6	1 CO	50	B	3RV16 11-1AG14	1	1 unit	101	0.314
2.5	2.5	10.5	1 CO	50	▶	3RV16 11-1CG14	1	1 unit	101	0.318
3	3	20	1 CO	50	▶	3RV16 11-1DG14	1	1 unit	101	0.315

Accessories

Version	Contacts	DT	Screw terminals	PU (UNIT, SET, M)	PS*	PG	Weight per PU approx.
			Order No.	Price per PU			kg

Mountable auxiliary switches for other signaling purposes



3RV19 01-1A

Lateral auxiliary switches With screw terminals, mountable on the left	1 NO + 1 NC	▶	3RV19 01-1A	1	1 unit	101	0.045
---	-------------	---	--------------------	---	--------	-----	-------

Additional auxiliary switches and other accessories see "Mountable accessories".

More information

Conversion of 3VU13 to 3RV1 voltage transformer circuit breakers

The 3VU13 voltage transformer circuit breakers previously available have been discontinued. The 3RV1 voltage transformer circuit breakers are offered as replacement types.

Previous type	Replacement type
3VU13 11-6HR00	3RV16 11-1CG14
3VU13 21-6HR00	3RV16 11-1CG14 + 3RV19 01-1A
3VU13 11-6JR00	3RV16 11-1DG14

3RV Motor Starter Protectors up to 100 A

Accessories

Mountable accessories

Overview

Mounting location and function

The 3RV1 motor starter protectors/circuit breakers have three main contact elements. In order to achieve maximum flexibility, auxiliary switches, signal switches, auxiliary trip units and isolator modules can be supplied separately.

These components can be fitted as required on the motor starter protectors/circuit breakers without using tools.

For overview graphic see "General data" --> "Overview".

Front side <u>Notes:</u> <ul style="list-style-type: none"> A maximum of 4 auxiliary contacts with auxiliary switches can be attached to each motor starter protector. Transverse auxiliary switches must not be used for the 3RV17 and 3RV18 circuit breakers. 	Transverse auxiliary switches 1 NO + 1 NC or 2 NO or 1 CO contact	An auxiliary switch block can be inserted transversely on the front. The overall width of the motor starter protectors remains unchanged.
Left-hand side <u>Notes:</u> <ul style="list-style-type: none"> A maximum of 4 auxiliary contacts with auxiliary switches can be attached to each motor starter protector/circuit breaker. Auxiliary switches (2 contacts) and signal switches can be mounted separately or together. The signal switch cannot be used for the 3RV17 and 3RV18 circuit breakers. 	Lateral auxiliary switches (2 contacts) 1 NO + 1 NC or 2 NO or 2 NC	One of the three auxiliary switches can be mounted laterally for each motor starter protector/circuit breaker. The contacts of the auxiliary switch close and open together with the main contacts of the motor starter protector/circuit breaker. The overall width of the lateral auxiliary switch with 2 contacts is 9 mm.
	Lateral auxiliary switches (4 contacts) 2 NO + 2 NC	One auxiliary switch can be mounted laterally for each motor starter protector. The contacts of the auxiliary switch close and open together with the main contacts of the motor starter protector/circuit breaker. The overall width of the lateral auxiliary switch with 4 contacts is 18 mm.
	Signal switches for sizes S0, S2 and S3 Tripping 1 NO + 1 NC Short-circuit 1 NO + 1 NC	One signal switch can be mounted at the side of each motor starter protector with a rotary operating mechanism. The signal switch has two contact systems. One contact system always signals tripping irrespective of whether this was caused by a short-circuit, an overload or an auxiliary trip unit. The other contact system only switches in the event of a short-circuit. There is no signaling as a result of switching off with the handle. In order to be able to switch on the motor starter protector again after a short-circuit, the signal switch must be reset manually after the error cause has been eliminated. The overall width of the signal switch is 18 mm.
Right-hand side <u>Notes:</u> <ul style="list-style-type: none"> One auxiliary trip unit can be mounted per motor starter protector/circuit breaker. Accessories cannot be mounted at the right-hand side of the 3RV11 motor starter protectors with overload relay function. 	Auxiliary trip units	Shunt trip units For remote-controlled tripping of the motor starter protector/circuit breaker. The release coil should only be energized for short periods (see schematics).
	or	Undervoltage trip units Trips the motor starter protector when the voltage is interrupted and prevents the motor from being restarted accidentally when the voltage is restored. Used for remote-controlled tripping of the motor starter protector/circuit breaker. Particularly suitable for EMERGENCY-STOP disconnection by way of the corresponding EMERGENCY-STOP pushbutton according to EN 60204-1.
	or Undervoltage trip unit with leading auxiliary contacts (2 NO)	Function and use as for the undervoltage trip unit without leading auxiliary contacts, but with the following additional function: the auxiliary contacts will open in switch position OFF to deenergize the coil of the undervoltage trip unit, thus interrupting energy consumption. In the "tripped" position, these auxiliary contacts are not guaranteed to open. The leading contacts permit the motor starter protector/circuit breaker to reclose. The overall width of the auxiliary trip unit is 18 mm.
Top <u>Notes:</u> <ul style="list-style-type: none"> The isolator module cannot be used for the 3RV17 and 3RV18 circuit breakers. The isolator module covers the terminal screws of the transverse auxiliary switch. If the isolator module is used, we therefore recommend that either the lateral auxiliary switches be fitted or that the isolator module not be mounted until the auxiliary switch has been wired. 	Isolator modules for sizes S0 and S2	Isolator modules can be mounted to the upper terminal end of motor starter protectors of sizes S0 and S2. The supply cable is connected to the motor starter protector through the isolator module. The plug can only be unplugged when the motor starter protector is open and isolates all 3 poles of the motor starter protector from the network. The shock-protected isolation point is clearly visible and secured with a padlock to prevent reinsertion of the plug.









For a complete overview of which accessories can be used for the various motor starter protectors see "Introduction" --> "Overview" --> "Motor starter protectors".

3RV Motor Starter Protectors up to 100 A





Accessories

Mountable accessories

Selection and ordering data

Version	Contacts	For motor starter protectors / circuit breakers Size	DT	Screw terminals 	PU (UNIT, SET, M)	PS*	PG	Weight per PU approx.	
				Order No.	Price per PU	kg			
Auxiliary switches¹⁾									
 3RV19 01-1E	Transverse auxiliary switches With screw terminals, mountable on front	1 CO 1 NO + 1 NC 2 NO	S00, S0, S2, S3	▶ ▶ ▶	3RV19 01-1D 3RV19 01-1E 3RV19 01-1F	1 1 1	1 unit 1 unit 1 unit	101 101 101	0.015 0.018 0.018
 3RV19 01-1G	Solid-state compatible transverse auxiliary switches With screw terminals, front mountable, for operation in dusty atmosphere and in solid-state circuits with low operating currents	1 CO	S00, S0, S2, S3	A	3RV19 01-1G	1	1 unit	101	0.016
 3RV19 01-0H	Covers for transverse auxiliary switches	--	S00, S0, S2, S3	▶	3RV19 01-0H	1	10 units	101	0.006
 3RV19 01-1A	Lateral auxiliary switches With screw terminals, mountable on the left	1 NO + 1 NC	S00, S0, S2, S3	▶	3RV19 01-1A	1	1 unit	101	0.045
 3RV19 01-1B		2 NO		▶	3RV19 01-1B	1	1 unit	101	0.045
 3RV19 01-1C		2 NC		▶	3RV19 01-1C	1	1 unit	101	0.045
 3RV19 01-1J		2 NO + 2 NC		A	3RV19 01-1J	1	1 unit	101	0.083

¹⁾ Each motor starter protector can be fitted with one transverse and one lateral auxiliary switch. The lateral auxiliary switch with 2 NO + 2 NC is used without a transverse auxiliary switch. Transverse auxiliary switches must not be used for the 3RV17 and 3RV18 circuit breakers.



Version	Contacts	For motor starter protectors Size	DT	Cage Clamp terminals 	PU (UNIT, SET, M)	PS*	PG	Weight per PU approx.	
				Order No.	Price per PU	kg			
Auxiliary switches¹⁾									
 3RV19 01-2E	Transverse auxiliary switches With Cage Clamp terminals, mountable on front	1 NO + 1 NC 2 NO	S00, S0, S2, S3	▶ ▶	3RV19 01-2E 3RV19 01-2F	1 1	1 unit 1 unit	101 101	0.017 0.018
 3RV19 01-2A	Lateral auxiliary switches With Cage Clamp terminals, mountable on left	1 NO + 1 NC	S00, S0, S2, S3	▶	3RV19 01-2A	1	1 unit	101	0.040
 3RV19 01-2B		2 NO		▶	3RV19 01-2B	1	1 unit	101	0.040
 3RV19 01-2C		2 NC		▶	3RV19 01-2C	1	1 unit	101	0.040

¹⁾ Each motor starter protector can be fitted with one transverse and one lateral auxiliary switch. Transverse auxiliary switches must not be used for the 3RV17 and 3RV18 circuit breakers.

3RV Motor Starter Protectors up to 100 A

Accessories

Mountable accessories



Version	For motor starter protectors Size	DT	Screw terminals 	PU (UNIT, SET, M)	PS*	PG	Weight per PU approx.	
			Order No.	Price per PU				
								kg
Signal switches¹⁾								
	Signal switches Separate tripped and short-circuit alarms, 1 NO + 1 NC each One signal switch can be mounted on the left per motor starter protector.	S0, S2, S3	▶	3RV19 21-1M	1	1 unit	101	0.094
3RV19 21-1M								
Isolator modules¹⁾								
	Isolator modules Visible isolating distance for isolating individual motor starter protectors from the network, lockable in disconnected position.	S0 S2	▶ ▶	3RV19 28-1A 3RV19 38-1A	1 1	1 unit 1 unit	101 101	0.157 0.324
3RV19 38-1A with padlock								

¹⁾ This accessory cannot be used for the 3RV17 and 3RV18 circuit breakers.

3RV Motor Starter Protectors up to 100 A

Accessories

Mountable accessories

Rated control supply voltage U_s					For motor starter protectors / circuit breakers Size	DT	Screw terminals 	PU (UNIT, SET, M)	PS*	PG	Weight per PU approx.	
AC 50 Hz	AC 60 Hz	AC 50/60 Hz	AC/DC 50/60 Hz, DC	DC								
V	V	V	V	V			Order No.	Price per PU			kg	
Auxiliary trip units³⁾												
Undervoltage trip units												
	--	--	--	--	24	S00, S0, S2, S3	A	3RV19 02-1AB4	1	1 unit	101	0.138
	24	--	--	--	--	S00, S0, S2, S3	A	3RV19 02-1AB0	1	1 unit	101	0.134
	110	120	--	--	--	S00, S0, S2, S3	A	3RV19 02-1AF0	1	1 unit	101	0.134
	--	208	--	--	--	S00, S0, S2, S3	A	3RV19 02-1AM1	1	1 unit	101	0.128
	230	240	--	--	--	S00, S0, S2, S3	▶	3RV19 02-1AP0	1	1 unit	101	0.131
	400	440	--	--	--	S00, S0, S2, S3	▶	3RV19 02-1AV0	1	1 unit	101	0.127
415	480	--	--	--	S00, S0, S2, S3	A	3RV19 02-1AV1	1	1 unit	101	0.129	
500	575	--	--	--	S00, S0, S2, S3	A	3RV19 02-1AS0	1	1 unit	101	0.127	
	Undervoltage trip units with leading auxiliary contacts 2 NO											
	230	240	--	--	--	S00	A	3RV19 12-1CP0	1	1 unit	101	0.140
	400	--	--	--	--	S00	A	3RV19 12-1CV0	1	1 unit	101	0.137
	415	480	--	--	--	S00	A	3RV19 12-1CV1	1	1 unit	101	0.139
	230	240	--	--	--	S0, S2, S3	A	3RV19 22-1CP0	1	1 unit	101	0.139
	400	--	--	--	--	S0, S2, S3	A	3RV19 22-1CV0	1	1 unit	101	0.136
415	480	--	--	--	S0, S2, S3	A	3RV19 22-1CV1	1	1 unit	101	0.138	
Shunt trip units												
--	--	20 ... 24	20 ... 70	--	--	S00, S0, S2, S3	▶	3RV19 02-1DB0	1	1 unit	101	0.133
--	--	90 ... 110	70 ... 190	--	--	S00, S0, S2, S3	A	3RV19 02-1DF0	1	1 unit	101	0.135
--	--	210 ... 240	190 ... 330	--	--	S00, S0, S2, S3	▶	3RV19 02-1DP0	1	1 unit	101	0.130
--	--	350 ... 415	330 ... 500	--	--	S00, S0, S2, S3	A	3RV19 02-1DV0	1	1 unit	101	0.129
--	--	500	500	--	--	S00, S0, S2, S3	A	3RV19 02-1DS0	1	1 unit	101	0.126

¹⁾ The voltage range is valid for 100 % (uninterrupted) ON period. The response voltage lies at 0.9 of the lower limit of the voltage range.

²⁾ The voltage range is valid for 5 s ON period at AC 50 Hz/60 Hz and DC. The response voltage lies at 0.85 of the lower limit of the voltage range.

³⁾ One auxiliary trip unit can be mounted on the right per motor starter protector.

3RV Motor Starter Protectors up to 100 A

Accessories

Busbar accessories

Overview

Insulated three-phase busbar systems

Three-phase busbar systems provide an easy, time-saving and clearly arranged means of feeding 3RV1 motor starter protectors with screw terminals. Different versions are available for sizes S00, S0 and S2 and can be used for the various different types of motor starter protectors. The only exceptions are the 3RV19 15 three-phase busbar systems, which are not suitable for the 3RV11 motor starter protectors with overload relay function. Furthermore, these must not be used with 3RV17 and 3RV18 circuit breakers.

The busbars are suitable for between 2 and 5 motor starter protectors. However, any kind of extension is possible by clamping the tags of an additional busbar (rotated by 180°) underneath the terminals of the respective last motor starter protector.

A combination of motor starter protectors of different sizes is possible only with sizes S00 and S0. Connecting pieces are available for this purpose. The motor starter protectors are supplied by appropriate feeder terminals.

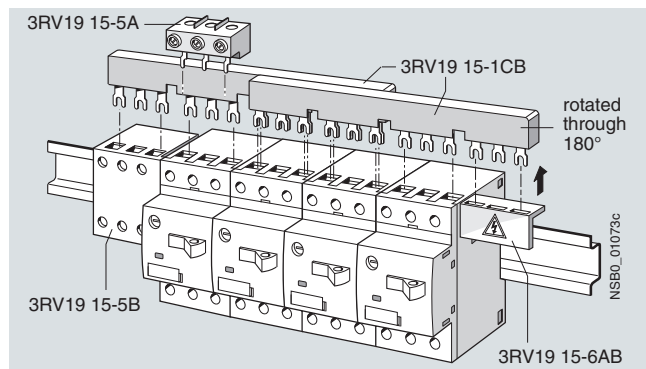

Three-phase busbar system, size S00

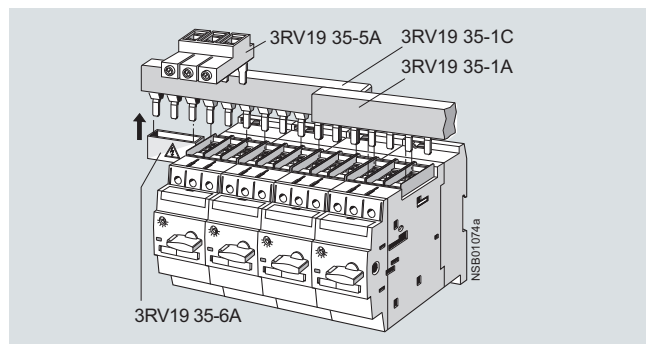

Three-phase busbar system, size S2

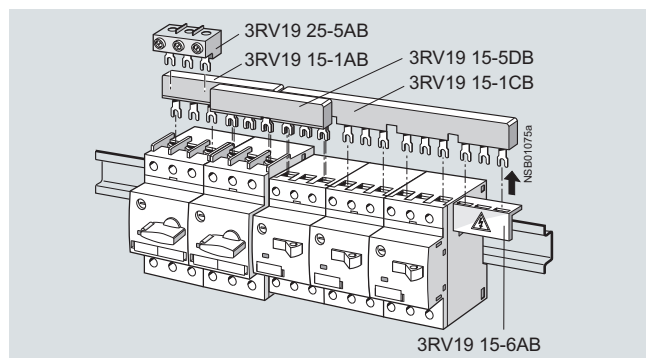

Three-phase busbar system, with example for combining sizes S00 and S0

The three-phase busbar systems are finger-safe. They are designed for any short-circuit stress which can occur at the output side of connected motor starter protectors.

The three-phase busbar systems can also be used to construct "Type E Starters" of size S0 or S2 according to UL/CSA. **Special feeder terminals must be used for this purpose, however (see "Selection and ordering data").**

Busbar adapters for 40 mm and 60 mm systems

The motor starter protectors are mounted directly with the aid of busbar adapters on busbar systems with 40 mm and 60 mm center-to-center clearance in order to save space and to reduce infeed times and costs.

Busbar adapters for busbar systems with 40 mm center-to-center clearance are suitable for copper busbars with a width of 12 mm to 15 mm, while those with 60 mm center-to-center clearance are suitable for copper busbars with a width of 12 mm to 30 mm. The busbars can be 4 to 5 mm or 10 mm thick.

The motor starter protectors are snapped onto the adapter and connected on the line side. This prepared unit is then plugged directly onto the busbar system, and is thus connected both mechanically and electrically at the same time.

Further busbar adapters for snap-mounting direct-on-line starters and reversing starters as well as additional accessories such as line terminals and outgoing terminals, flat copper profile, etc., can be found under "Distribution/Busbar Systems and Switchgear".

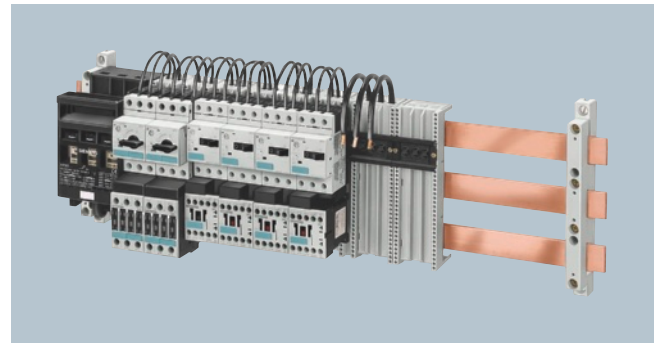

SIRIUS motor starter protectors and load feeders with busbar adapters snapped onto busbars



SIRIUS 3RV19 infeed system with three 3RV10 11 motor starter protectors, two 3RV10 21 motor starter protectors, three 3RT10 16 contactors and two 3RT10 24 contactors

The 3RV19 infeed system can be found under "Load Feeders, Motor Starters and Soft Starters" --> "3RA Fuseless Load Feeders".

3RV Motor Starter Protectors up to 100 A

Accessories





Busbar accessories

Selection and ordering data

Modular spacing	Number of motor starter protectors that can be connected			Rated current I_n at 690 V	For motor starter protectors Size	DT	Order No.	Price per PU	PU (UNIT, SET, M)	PS*	PG	Weight per PU approx.
	Without lateral accessories	Incl. lateral auxiliary switch	With auxiliary trip unit									
mm				A								kg

Three-phase busbar systems

For feeding several motor starter protectors with screw terminals, mounted side-by-side on standard mounting rails, insulated, with touch protection.

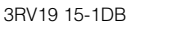
 3RV19 15-1AB	45	2	--	--	63	S00, S0 ¹⁾²⁾	▶	3RV19 15-1AB	1	1 unit	101	0.044
		3				S00, S0 ¹⁾²⁾	▶	3RV19 15-1BB	1	1 unit	101	0.071
		4				S00, S0 ¹⁾²⁾	▶	3RV19 15-1CB	1	1 unit	101	0.099
		5				S00, S0 ¹⁾²⁾	▶	3RV19 15-1DB	1	1 unit	101	0.124
 3RV19 15-1BB	55	--	2	--	63	S00, S0 ¹⁾²⁾	▶	3RV19 15-2AB	1	1 unit	101	0.048
			3			S00, S0 ¹⁾²⁾	▶	3RV19 15-2BB	1	1 unit	101	0.079
			4			S00, S0 ¹⁾²⁾	▶	3RV19 15-2CB	1	1 unit	101	0.111
			5			S00, S0 ¹⁾²⁾	▶	3RV19 15-2DB	1	1 unit	101	0.140
 3RV19 15-1CB	63	--	--	2	63	S00, S0 ¹⁾²⁾	▶	3RV19 15-3AB	1	1 unit	101	0.052
				4		S00, S0 ¹⁾²⁾	▶	3RV19 15-3CB	1	1 unit	101	0.120
 3RV19 15-1DB	55	2	--	--	108	S2	▶	3RV19 35-1A	1	1 unit	101	0.150
		3				S2	▶	3RV19 35-1B	1	1 unit	101	0.214
		4				S2	▶	3RV19 35-1C	1	1 unit	101	0.295
 3RV19 15-1DB	75	--	2	2	108	S2 ³⁾	A	3RV19 35-3A	1	1 unit	101	0.161
			3	3		S2 ³⁾	A	3RV19 35-3B	1	1 unit	101	0.262
			4	4		S2 ³⁾	A	3RV19 35-3C	1	1 unit	101	0.369

1) Not suitable for 3RV11 motor starter protectors with overload relay function. Common clamping of S00 and S0 motor starter protectors is not possible, due to the different modular spacings and terminal heights. The 3RV19 15-DB connecting piece is available for connecting busbars from size S0 to size S00.

2) Not suitable for 3RV17 and 3RV18 circuit breakers.

3) Auxiliary trip units and lateral auxiliary switches cannot be used in combination.



Version	Modular spacing	For motor starter protectors Size	DT	Order No.	Price per PU	PU (UNIT, SET, M)	PS*	PG	Weight per PU approx.
	mm								kg

Connecting pieces for three-phase busbars

 3RV19 15-5DB	45	S00, S0	▶	3RV19 15-5DB	1	1 unit	101	0.042
	For connecting three-phase busbars for motor starter protectors of size S0 (left) to size S00 (right)							

Conductor cross-section			Tightening torque	For motor starter protectors Size	DT	Order No.	Price per PU	PU (UNIT, SET, M)	PS*	PG	Weight per PU approx.
Solid or stranded	Finely stranded with end sleeve	AWG cables, solid or stranded									
mm ²	mm ²	AWG	Nm								kg

Three-phase feeder terminals

 3RV19 25-5AB	Connection from top			2.5 ... 25	4 ... 16	12-4	4	S00	▶	3RV19 15-5A	1	1 unit	101	0.040
								S0	▶	3RV19 25-5AB	1	1 unit	101	0.041
 3RV19 15-5B	Connection from below¹⁾			2.5 ... 25	4 ... 16	12-4	Input: 4, Output: 2 ... 2.5	S00, S0	▶	3RV19 15-5B	1	1 unit	101	0.110
	Connection from top			2.5 ... 50	1.5 ... 35	14-0	4	S2	▶	3RV19 35-5A	1	1 unit	101	0.110

Three-phase feeder terminals for constructing "Type E Starters"

Connection from top			2.5 ... 25	4 ... 16	10-4	2-4	S0	C	3RV19 25-5EB	1	1 unit	101	0.055
			10 ... 50	--	8-0	4.5-6	S2	A	3RV19 35-5E	1	1 unit	101	0.100

1) This terminal is connected in place of a switch, please take the space requirement into account.

3RV Motor Starter Protectors up to 100 A

Accessories

Busbar accessories

Version	For motor starter protectors Size	DT	Order No.	Price per PU	PU (UNIT, SET, M)	PS*	PG	Weight per PU approx. kg
---------	-----------------------------------	----	-----------	--------------	-------------------	-----	----	--------------------------

Covers for connection tags



3RV19 15-6AB

Touch protection for empty positions

S00, S0

▶ **3RV19 15-6AB**

1 10 units

101

0.003

S2

▶ **3RV19 35-6A**

1 5 units

101

0.006

Busbar adapters



8US10 61-5DJ07



8US12 51-5MD07

For motor starter protectors Size	Rated current A	Connecting cable AWG	Adapter length mm	Adapter width mm	Rated voltage V	DT	Order No.	Price per PU	PU (UNIT, SET, M)	PS*	PG	Weight per PU approx. kg
-----------------------------------	-----------------	----------------------	-------------------	------------------	-----------------	----	-----------	--------------	-------------------	-----	----	--------------------------

Busbar adapters for 40 mm systems

For flat copper profiles according to DIN 46433
Width: 12 mm and 15 mm
Thickness: 5 mm and 10 mm

S00, S0	25	12	121	45	690	▶	8US10 51-5DJ07		1	1 unit	143	0.106
S00, S0 + lateral auxiliary switch	25	12	121	55	690	▶	8US10 61-5DJ07		1	1 unit	143	0.119
S2	56	8	139	55	690	▶	8US10 61-5FK08		1	1 unit	143	0.231
S3	100	4	182	70	400 ¹⁾	▶	8US11 11-4SM00		1	1 unit	143	0.541
S3	100	4	182	72	415 ... 690 ²⁾	▶	8US10 11-4TM00		1	1 unit	143	0.478

Busbar adapters for 60 mm systems

For flat copper profiles according to DIN 46433
Width: 12 mm and 30 mm
Thickness: 5 mm and 10 mm
also for T and double-T special profiles

S00, S0	25	12	182	45	690	▶	8US12 51-5DM07		1	1 unit	143	0.183
S2	56	8		55	690	▶	8US12 61-5FM08		1	1 unit	143	0.263
S3	100	4		70	400 ¹⁾	▶	8US11 11-4SM00		1	1 unit	143	0.541
S3	100	4		72	415 ... 690 ²⁾	▶	8US12 11-4TM00		1	1 unit	143	0.498

¹⁾ At rated voltage
≤ 400 V: short-circuit breaking capacity 50 kA,
> 400 V to 460 V: short-circuit breaking capacity 25 kA.

²⁾ Short-circuit breaking capacity 415/500/525 V AC:
- up to $I_n = 25$ A: max. 30 kA
- up to $I_n = 90$ A: max. 16 kA
- up to $I_n = 100$ A: max. 6 kA;
Short-circuit breaking capacity 690 V AC:
- max. 12 kA.

For additional busbar adapters see "SIVACON Power Distribution Boards, Busway and Cubicle Systems" --> "Components for 8US, 8UC, 4NC distribution systems: 8US busbar systems".

Overview

Door-coupling rotary operating mechanisms

Motor starter protectors/circuit breakers with a rotary operating mechanism can be mounted in a control cabinet and operated externally by means of a door-coupling rotary operating mechanism. When the cabinet door with motor starter protector/circuit breaker is closed, the operating mechanism is coupled. When the motor starter protector/circuit breaker closes, the coupling is locked which prevents the door from being opened unintentionally. This interlock can be defeated by the maintenance personnel. In the Open position, the rotary operating mechanism can be secured against reclosing with up to 3 padlocks. Inadvertent opening of the door is not possible in this case either.

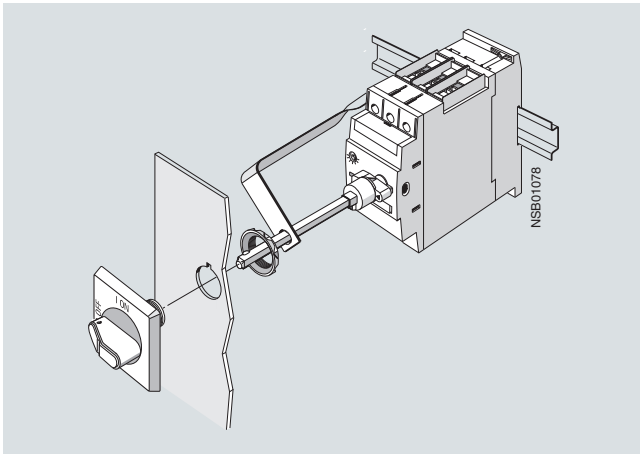

3RV19 26-0K door-coupling rotary operating mechanism

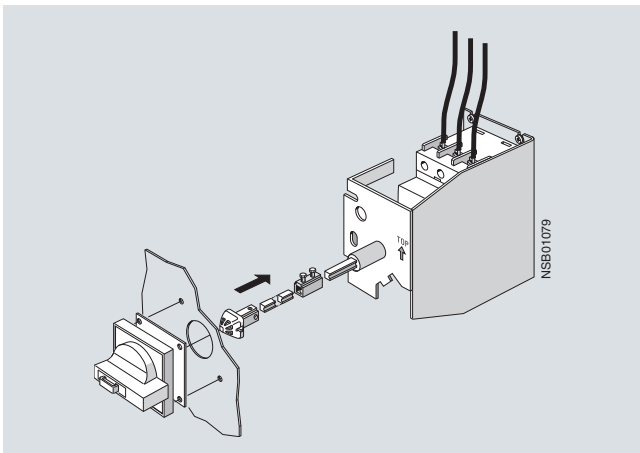

3RV29 26-2B door-coupling rotary operating mechanism for arduous conditions

Remote motorized operating mechanisms

3RV1 motor starter protectors are manually operated controls. They automatically trip in case of an overload or short-circuit. Intentional remote-controlled tripping is possible by means of a shunt trip unit or an undervoltage trip unit. Reclosing is only possible directly at the motor starter protector.

The remote motorized operating mechanism allows the motor starter protectors to be opened and closed by electrical commands. This enables a load or an installation to be isolated from the network or reconnected to it from an operator panel.

If the motor starter protector is tripped as a result of overload or short-circuit, it will be in tripped position. For reclosing, the remote motorized operating mechanism must first be set manually or electrically to the 0 position (electrically by means of the Open command). Then it can be reclosed.

The remote motorized operating mechanism is available for motor starter protectors of size S2 ($I_{n\max} = 50\text{ A}$) and S3 ($I_{n\max} = 100\text{ A}$) that are designed for control voltages of 230 V AC and 24 V DC. The motor starter protector is fitted into the remote motorized operating mechanism as shown in the drawing.

In the "MANUAL" position, the motor starter protector in the remote motorized operating mechanism can continue to be switched manually on site. In the "AUTOMATIC" position, the motor starter protector is switched by means of electrical commands. The switching command must be applied for a minimum of 100 ms. The remote motorized operating mechanism closes the motor starter protector after a maximum of 1 second. On voltage failure during the switching operation it is ensured that the motor starter protector remains in the OPEN or CLOSED position. In the "MANUAL" and "OFF" position, the remote motorized operating mechanism can be locked with a padlock.

RESET function

The RESET button on the motorized operating mechanism serves to reset any 3RV19 21-1M signal switch that might be installed.

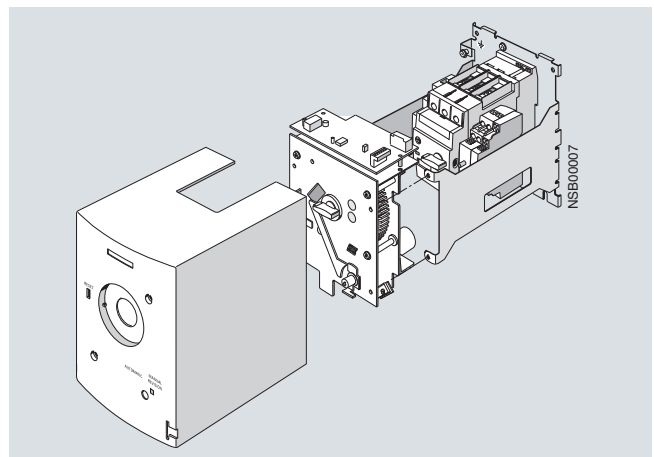

3RV19 .6-3A.. remote motorized operating mechanism

3RV Motor Starter Protectors up to 100 A

Accessories

Rotary operating mechanisms

Selection and ordering data

Version	Color of handle	Version of extension shaft	For motor starter protectors Size	DT	Order No.	Price per PU	PU (UNIT, SET, M)	PS*	PG	Weight per PU approx.
---------	-----------------	----------------------------	-----------------------------------	----	-----------	--------------	-------------------	-----	----	-----------------------

mm

kg

Door-coupling rotary operating mechanisms



3RV19 26-0B

The door-coupling rotary operating mechanisms consist of a knob, a coupling driver and an extension shaft of 130/330 mm in length (5 mm x 5 mm).

The door-coupling rotary operating mechanisms are designed to degree of protection IP65. The door locking device prevents accidental opening of the control cabinet door in the ON position of the motor starter protector. The OFF position can be locked with up to 3 padlocks.

Door-coupling rotary operating mechanisms	Black	130	S0, S2, S3	▶	3RV19 26-0B		1	1 unit	101	0.111
		330		▶	3RV19 26-0K		1	1 unit	101	0.324
EMERGENCY-STOP door-coupling rotary operating mechanisms	Red/	130	S0, S2, S3	▶	3RV19 26-0C		1	1 unit	101	0.110
	Yellow	330		▶	3RV19 26-0L		1	1 unit	101	0.316

Door-coupling rotary operating mechanisms for arduous conditions



3RV29 36-2B

The door-coupling rotary operating mechanisms consist of a knob, a coupling driver, an extension shaft of 300 mm in length (8 mm x 8 mm), a spacer and two metal brackets, into which the motor starter protector is inserted.

The door-coupling rotary operating mechanisms are designed to degree of protection IP65. The door interlocking reliably prevents opening of the control cabinet door in the ON position of the motor starter protector. The OFF position can be locked with up to 3 padlocks.

Laterally mountable auxiliary trip units and two-pole auxiliary switches can be used.

The door-coupling rotary operating mechanisms thus meet the requirements for isolating functions according to IEC 60947-2.

Door-coupling rotary operating mechanisms	Gray	300	S0	▶	3RV29 26-2B		1	1 unit	101	1.180
			S2	▶	3RV29 36-2B		1	1 unit	101	1.570
			S3	▶	3RV29 46-2B		1	1 unit	101	1.722
EMERGENCY-STOP door-coupling rotary operating mechanisms	Red/	300	S0	▶	3RV29 26-2C		1	1 unit	101	1.188
	Yellow		S2	▶	3RV29 36-2C		1	1 unit	101	1.486
			S3	▶	3RV29 46-2C		1	1 unit	101	1.732

Version	Rated control supply voltage U_s	For motor starter protectors Size	DT	Order No.	Price per PU	PU (UNIT, SET, M)	PS*	PG	Weight per PU approx.
---------	------------------------------------	-----------------------------------	----	-----------	--------------	-------------------	-----	----	-----------------------

kg

Remote motorized operating mechanisms



3RV19 .6-3A..

Remote motorized operating mechanisms	50/60 Hz, 230 V AC	S2	B	3RV19 36-3AP0		1	1 unit	101	3.520
	24 V DC	S2	B	3RV19 36-3AB4		1	1 unit	101	3.420
	50/60 Hz, 230 V AC	S3	B	3RV19 46-3AP0		1	1 unit	101	3.441
	24 V DC	S3	B	3RV19 46-3AB4		1	1 unit	101	3.357

3RV Motor Starter Protectors up to 100 A

Accessories

Mounting accessories

Overview

Solder pin connections

Solder pin connections are available for the main contacts and transverse auxiliary switches of size S00 motor starter protectors.

The prepared terminal parts are clamped to the upper and lower screw terminals of the motor starter protectors which allows them to be soldered into printed circuit boards.

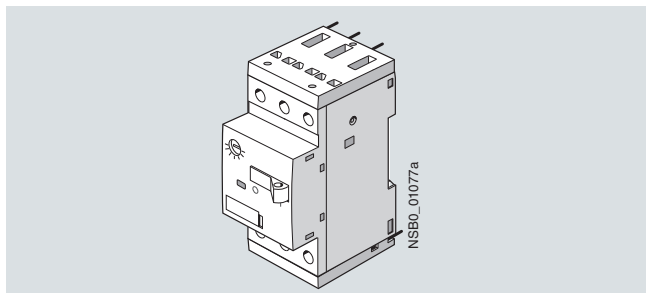

3RV19 18-5A

Terminals for "Self-Protected Combination Motor Controllers (Type E)" according to UL 508

The 3RV10 motor starter protectors size S0 and higher are approved according to UL 508 as "Self-Protected Combination Motor Controllers (Type E)".

This requires increased clearance and creepage distances (1 inch and 2 inches respectively) at the input side of the device, which are achieved by mounting terminal blocks.

- Size S0: The 3RV19 28-1H terminal block is simply screwed onto the basic unit.
- Size S2: The basic unit is already compliant with the new clearance and creepage distance requirements.
- Size S3: The standard box terminal must be replaced by the 3RT19 46-4GA07 terminal block.

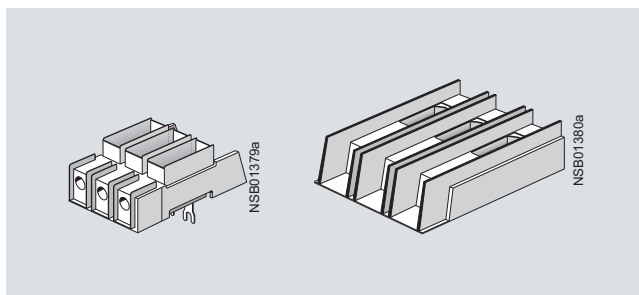

3RV19 28-1H (left), 3RT19 46-4GA07 (right)

According to CSA, these terminal blocks can be omitted when the device is used as a "Self-Protected Combination Motor Controller" (Type E).

Three-phase feeder terminals are required for constructing "Type E Starters" with an insulated busbar system (see "Busbar accessories").

Selection and ordering data

Version	For motor starter protectors Size	DT	Order No.	Price per PU	PU (UNIT, SET, M)	PS*	PG	Weight per PU approx. kg
---------	-----------------------------------	----	-----------	--------------	-------------------	-----	----	--------------------------

Covers



3RV1 (size S3) with 3RT19 46-4EA1 (left) 3RV19 08-0P (right)

Terminal covers for box terminals Additional touch protection to be fitted at the box terminals (2 units mountable per device)	S2	▶	3RT19 36-4EA2		1	1 unit	101	0.020
	S3	▶	3RT19 46-4EA2		1	1 unit	101	0.025
	S3	▶	3RT19 46-4EA1		1	1 unit	101	0.040
Terminal covers For cable lug and busbar connection for maintaining the required voltage clearance and as touch protection if box terminal is removed (2 units can be mounted per motor starter protector)	S3	▶	3RT19 46-4EA1		1	1 unit	101	0.040
Scale covers Sealable, for covering the current setting scale	S00, S0, S2, S3	▶	3RV19 08-0P		100	10 units	101	0.100

* You can order this quantity or a multiple thereof.

3RV Motor Starter Protectors up to 100 A

Accessories

Mounting accessories

Version	For motor starter protectors Size	DT	Order No.	Price per PU	PU (UNIT, SET, M)	PS*	PG	Weight per PU approx. kg
---------	-----------------------------------	----	-----------	--------------	-------------------	-----	----	-----------------------------

Fixing accessories



3RB19 00-0B

Push-in lugs

For screwing the motor starter protector onto mounting plates.

For each motor starter protector, 2 units are required.

S00, S0

A

3RB19 00-0B

100

10 units

101

0.100

Solder pin connections



3RV19 18-5A with motor starter protector

For main contacts

For soldering the main conductor connections of a motor starter protector to a printed circuit board

(1 set = 2 units per motor starter protector)

S00

B

3RV19 18-5A

1

4 units

101

0.030

For main and auxiliary contacts

For soldering the main conductor connections and the auxiliary conductor connections of the transverse auxiliary switch 1 NO + 1 NC of a motor starter protector to a printed circuit board

(1 set = 3 units per motor starter protector)

S00

B

3RV19 18-5B

1

4 units

101

0.044

Version	For motor starter protectors Size	DT	Order No.	Price per PU	PU (UNIT, SET, M)	PS*	PG	Weight per PU approx. kg
---------	-----------------------------------	----	-----------	--------------	-------------------	-----	----	-----------------------------

Terminals for "Self-Protected Combination Motor Controllers (Type E)" according to UL 508



3RV19 28-1H

Note: UL 508 demands for "Combination Motor Controller Type E" 1-inch clearance and 2-inch creepage distance at line side. The following terminal blocks must be used in 3RV10 motor starter protectors of sizes S0 and S3.

The 3RV10 motor starter protector in size S2 conforms with the required clearance and creepage distances without a terminal block. Terminal blocks are not required for use according to CSA.

With size S0, these terminal blocks cannot be used in combination with 3RV19 .5 three-phase busbars and with size S3, they cannot be used with a transverse auxiliary switch.

For construction with three-phase busbars, see "Busbar accessories".



3RT19 46-4GA07

Terminal blocks type E

For extended clearance and creepage distances (1 and 2 inch)

S0
S3▶
A3RV19 28-1H
3RT19 46-4GA07

1

1 unit

101

0.083

1

1 unit

101

0.155

Version	For motor starter protectors Size	DT	Order No.	Price per PU	PU (UNIT, SET, M)	PS*	PG	Weight per PU approx. kg
---------	-----------------------------------	----	-----------	--------------	-------------------	-----	----	-----------------------------

Auxiliary terminals, 3-pole



3RT19 46-4F

For connection of auxiliary and control cables to the main conductor connections (for one side)

S3

B

3RT19 46-4F

1

1 unit

101

0.035

3RV Motor Starter Protectors up to 100 A

Accessories

Mounting accessories

Version	Method of operation	Size	Contac-tors	Motor starter protectors	DT	Screw terminals 	PU (UNIT, SET, M)	PS*	PG	Weight per PU approx.	
						Order No.	Price per PU				kg

Link modules, single-unit packaging



3RA19 11-1AA00

For mechanical and electrical connection between contactor and motor starter protector with screw terminals

Method of operation	Size	Contac-tors	Motor starter protectors	DT	Order No.	Price per PU	PU (UNIT, SET, M)	PS*	PG	Weight per PU approx.
AC/DC	S00	S00	S00	▶	3RA19 11-1AA00		1	1 unit	101	0.027
	S00	S00	S0	▶	3RA19 21-1DA00		1	1 unit	101	0.028
AC	S0	S0	S0	▶	3RA19 21-1AA00		1	1 unit	101	0.037
	S2	S2	S2	▶	3RA19 31-1AA00		1	1 unit	101	0.042
	S3	S3	S3	▶	3RA19 41-1AA00		1	1 unit	101	0.090
DC	S0	S0	S0	▶	3RA19 21-1BA00		1	1 unit	101	0.039
	S2	S2	S2	▶	3RA19 31-1BA00		1	1 unit	101	0.043
	S3	S3	S3	▶	3RA19 41-1BA00		1	1 unit	101	0.089

Link modules, multi-unit packaging

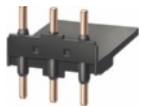

3RA19 31-1A

For mechanical and electrical connection between contactor and motor starter protector with screw terminals

Method of operation	Size	Contac-tors	Motor starter protectors	DT	Order No.	Price per PU	PU (UNIT, SET, M)	PS*	PG	Weight per PU approx.
AC/DC	S00	S00	S00	▶	3RA19 11-1A		1	10 units	101	0.019
	S00	S00	S0	▶	3RA19 21-1D		1	10 units	101	0.021
AC	S0	S0	S0	▶	3RA19 21-1A		1	10 units	101	0.028
	S2	S2	S2	▶	3RA19 31-1A		1	5 units	101	0.033
	S3	S3	S3	▶	3RA19 41-1A		1	5 units	101	0.072
DC	S0	S0	S0	▶	3RA19 21-1B		1	10 units	101	0.030
	S2	S2	S2	▶	3RA19 31-1B		1	5 units	101	0.034
	S3	S3	S3	▶	3RA19 41-1B		1	5 units	101	0.073

Version	Method of operation	Size	Contac-tors	Motor starter protectors	DT	Order No.	Price per PU	PU (UNIT, SET, M)	PS*	PG	Weight per PU approx.
											kg

Hybrid link modules, single-unit packaging



3RA19 11-2FA00

Electrical and mechanical connection between motor starter protector with screw terminals and contactor with Cage Clamp terminals

Method of operation	Size	Contac-tors	Motor starter protectors	DT	Order No.	Price per PU	PU (UNIT, SET, M)	PS*	PG	Weight per PU approx.
AC/DC	S00	S00	S00	▶	3RA19 11-2FA00		1	1 unit	101	0.038
	S00	S00	S0	▶	3RA19 21-2FA00		1	1 unit	101	0.028

Hybrid link modules, multi-unit packaging



3RA19 11-2F

Electrical and mechanical connection between motor starter protector with screw terminals and contactor with Cage Clamp terminals

Method of operation	Size	Contac-tors	Motor starter protectors	DT	Order No.	Price per PU	PU (UNIT, SET, M)	PS*	PG	Weight per PU approx.
AC/DC	S00	S00	S00	▶	3RA19 11-2F		1	10 units	101	0.031
	S00	S00	S0	▶	3RA19 21-2F		1	10 units	101	0.030

3RV Motor Starter Protectors up to 100 A

Accessories

Mounting accessories

Version	Size	DT	Cage Clamp terminals 	PU (UNIT, SET, M)	PS*	PG	Weight per PU approx.	
			Order No.	Price per PU				kg

Adapters and link modules for Cage Clamp terminals



3RA19 11-2A +
8US10 51-5CM47



3RA19 11-2E

Link modules, Cage Clamp Electrical connection between motor starter protector and contactor (busbar adapter not included in scope of supply)	S00	▶	3RA19 11-2A	1	10 units	101	0.016
Link modules, Cage Clamp with mechanical connections Mechanical and electrical connection between motor starter protector and contactor	S00	▶	3RA19 11-2E	1	10 units	101	0.028
Standard mounting rail adapters With 2 standard mounting rails 45 mm wide, one movable	S00	▶	3RA19 22-1L	1	5 units	101	0.413
Busbar adapters 45 mm wide, 182 mm long, adapted for Cage Clamp motor starter protectors. An additional standard mounting rail must be mounted for an additional contactor.	40 mm busbar system	▶	8US10 51-5CM47	1	1 unit	143	0.193
	60 mm busbar system	▶	8US12 51-5CM47	1	1 unit	143	0.190
35 mm standard mounting rails Plastic, including fixing screws	--	A	8US19 98-7CA15	1	10 units	143	0.009

Version	Size	DT	Cage Clamp terminals 	PU (UNIT, SET, M)	PS*	PG	Weight per PU approx.	
			Order No.	Price per PU				kg

Tools for opening Cage Clamp terminals



8WA2 803

Screwdrivers For all SIRIUS devices with Cage Clamp terminals up to max. 2.5 mm ² conductor cross-section	Length approx. 175 mm; green, partially insulated	C	8WA2 880	1	1 unit	041	0.034
	Length approx. 175 mm; green	C	8WA2 803	1	1 unit	041	0.024

3RV Motor Starter Protectors up to 100 A

Accessories

Enclosures and front plates

Overview

Enclosures

For stand-alone installation of motor starter protectors of sizes S00 ($I_{n\max} = 12\text{ A}$), S0 ($I_{n\max} = 25\text{ A}$) and S2 ($I_{n\max} = 50\text{ A}$), molded-plastic enclosures for surface mounting and molded-plastic enclosures for flush mounting are available in various dimensions.

When installed in a molded-plastic enclosure the motor starter protectors have a rated operational voltage U_e of 500 V.

The enclosures for surface mounting have the degree of protection IP55; the enclosures for flush mounting also comply with the degree of protection IP55 at the front (the flush-mounted section complies with IP20).

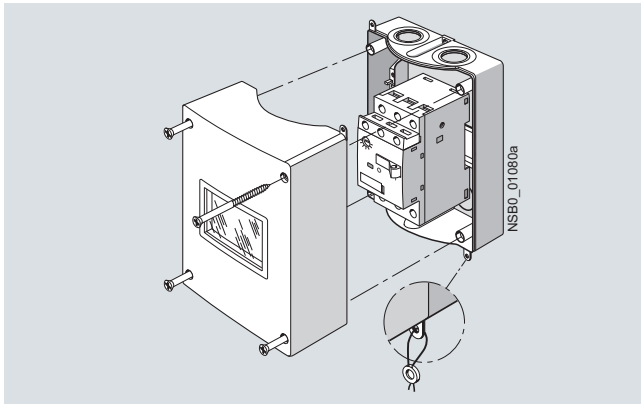

Enclosure for surface mounting

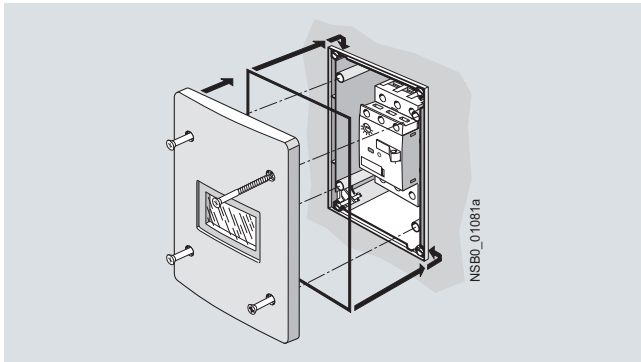

Enclosure for flush mounting

All enclosures are equipped with N and PE-terminals. There are two knock-out cable entries for cable glands at the top and two at the bottom; also on the rear corresponding cable entries are scored. There is a knockout on the top of the enclosure for indicator lights that are available as accessories.

The narrow enclosure can accommodate a motor starter protector without accessories, with transverse and lateral auxiliary switch, whereas wide enclosures and enclosures for S2 motor starter protectors also provide space for a laterally mounted auxiliary trip unit. There is no provision for installing a motor starter protector with a signal switch.

With S00 motor starter protectors, the switch rocker is operated by means of the actuator diaphragm of the enclosure. A locking device, capable of holding up to three padlocks, can be fitted onto the actuator diaphragm to prevent the motor starter protector from closing during maintenance work, for example.

A mushroom-shaped EMERGENCY-STOP knob can be fitted in place of the locking device. If it is actuated abruptly, the motor starter protector opens and the mushroom-shaped knob latches. The knob can be unlatched again either by turning it or by using a special key. The motor starter protector can subsequently be switched on again.

The molded-plastic enclosures of S0 and S2 motor starter protectors with rotary operating mechanism are fitted with a rotary operating mechanism as well.

The enclosures can be supplied with a black rotary operating mechanism or with an EMERGENCY-STOP rotary operating mechanism with a red/yellow knob.

All rotary operating mechanisms can be locked in the open position with up to 3 padlocks.

Front plates

Motor starter protectors are frequently required to be actuated in any enclosure. Front plates equipped with an actuator diaphragm for size S00 motor starter protectors, or rotary operating mechanism for S0 to S3 motor starter protectors are available for this purpose.

The front plates for size S00 have a holder into which the motor starter protectors can be snapped. A holder for size S0 motor starter protectors is available for front plate sizes S0 to S3.

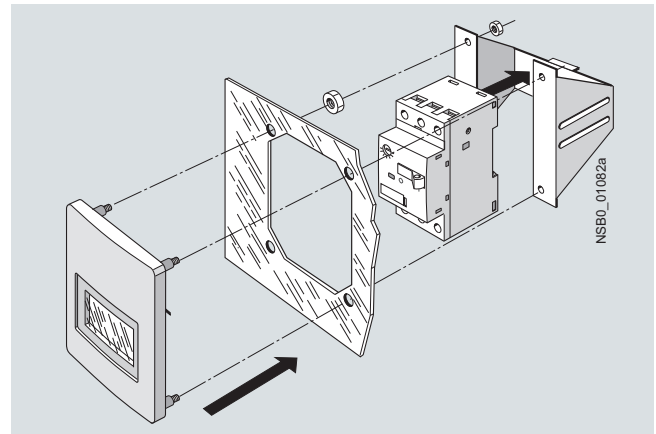

Front plate for size S00

Accessories for enclosures and front plates

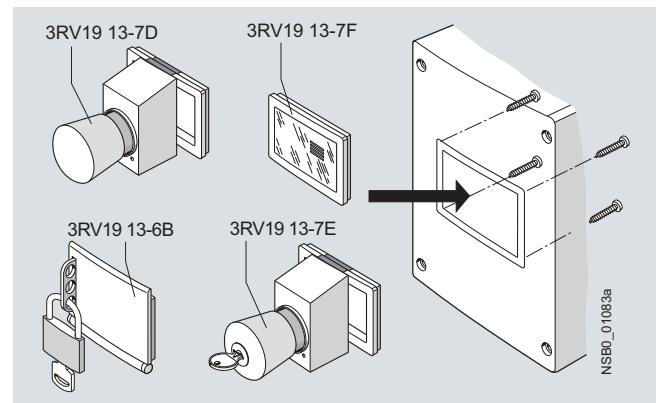





Accessories for size S00

3RV Motor Starter Protectors up to 100 A

Accessories

Enclosures and front plates

Selection and ordering data

Version	Degree of protection	Integrated terminals	Overall width	For motor starter prot. Size	DT	Order No.	Price per PU	PU (UNIT, SET, M)	PS*	PG	Weight per PU approx. kg				
Molded-plastic enclosures for surface mounting															
	With actuator diaphragm	IP55	N and PE	54 mm (for protector + lateral auxiliary switch)	S00	▶ 3RV19 13-1CA00		1	1 unit	101	0.296				
				72 mm (for protector + lateral auxiliary switch + auxiliary trip unit)	S00	▶ 3RV19 13-1DA00		1	1 unit	101	0.342				
	With rotary operating mechanism, lockable in 0 position	IP55	N and PE	54 mm (for protector + lateral auxiliary switch)	S0	▶ 3RV19 23-1CA00		1	1 unit	101	0.332				
				72 mm (for protector + lateral auxiliary switch + auxiliary trip unit)	S0	▶ 3RV19 23-1DA00		1	1 unit	101	0.381				
				82 mm (for protector + lateral auxiliary switch + auxiliary trip unit)	S2	A	3RV19 33-1DA00		1	1 unit	101	1.134			
	With EMERGENCY-STOP rotary operating mechanism, lockable in 0 position	IP55	N and PE	54 mm (for protector + lateral auxiliary switch)	S0	▶ 3RV19 23-1FA00		1	1 unit	101	0.329				
				72 mm (for protector + lateral auxiliary switch + auxiliary trip unit)	S0	▶ 3RV19 23-1GA00		1	1 unit	101	0.372				
				82 mm (for protector + lateral auxiliary switch + auxiliary trip unit)	S2	A	3RV19 33-1GA00		1	1 unit	101	1.136			
Cast aluminum enclosures for surface mounting															
	With rotary operating mechanism, lockable in 0 position	IP65	PE ¹⁾	72 mm (for protector + lateral auxiliary switch + auxiliary trip unit)	S0	▶ 3RV19 23-1DA01		1	1 unit	101	1.015				
				72 mm (for protector + lateral auxiliary switch + auxiliary trip unit)	S0	A	3RV19 23-1GA01		1	1 unit	101	1.008			
	With actuator diaphragm	IP55 (front side)	N and PE	72 mm (for protector + lateral auxiliary switch + auxiliary trip unit)	S00	A	3RV19 13-2DA00		1	1 unit	101	0.416			
				With rotary operating mechanism, lockable in 0 position	IP55 (front side)	N and PE	72 mm (for protector + lateral auxiliary switch + auxiliary trip unit)	S0	A	3RV19 23-2DA00		1	1 unit	101	0.426
							With EMERGENCY-STOP rotary operating mechanism, lockable in 0 position	IP55 (front side)	N and PE	72 mm (for protector + lateral auxiliary switch + auxiliary trip unit)	S0	A	3RV19 23-2GA00		1

¹⁾ If required, an additional N terminal can be mounted (e. g. 8WA1 011-1BG11).

3RV Motor Starter Protectors up to 100 A

Accessories

Enclosures and front plates

Version	Degree of protection	For motor starter protectors Size	DT	Order No.	Price per PU	PU (UNIT, SET, M)	PS*	PG	Weight per PU approx. kg
---------	----------------------	-----------------------------------	----	-----------	--------------	-------------------	-----	----	-----------------------------

Front plates



3RV19 13-4C

Molded-plastic front plates with actuator diaphragm

For actuating 3RV1 motor starter protectors in any enclosures, includes holder for motor starter protector.

IP55 (front side)

S00

A

3RV19 13-4C

1

1 unit

101

0.216

3RV19 23-4B +
3RV19 23-4G

Molded-plastic front plates with rotary operating mechanism

Lockable in 0 position
For actuation of 3RV1 motor starter protectors in any enclosure.

IP55 (front side)

S0, S2, S3

▶

3RV19 23-4B

1

1 unit

101

0.124

Molded-plastic front plates with EMERGENCY-STOP rotary operating mechanism, red/yellow, lockable in 0 position

EMERGENCY-STOP actuation of 3RV1 motor starter protectors in any enclosure.

IP55 (front side)

S0, S2, S3

A

3RV19 23-4E

1

1 unit

101

0.124

Holders for front plates

Holder is mounted on front plate, motor starter protector with and without accessories is snapped in.

--

S0

▶

3RV19 23-4G

1

1 unit

101

0.188

Accessories for enclosures



Molded-plastic enclosure for surface mounting with 3RV19 13-7D

EMERGENCY-STOP mushroom buttons red/yellow

For 3RV19 13-... enclosures and front plates

Latching mushroom buttons, unlatch by turning

Cannot be used in combination with locking device

IP55

S00

▶

3RV19 13-7D

1

1 unit

101

0.108

EMERGENCY-STOP mushroom buttons red/yellow, with lock

For 3RV19 13-... enclosures and front panels

RONIS lock, lock number SB 30, supplied with 2 keys

Latching mushroom button, unlatch with key

Cannot be used in combination with locking device

IP55

S00

A

3RV19 13-7E

1

1 unit

101

0.144

Locking devices

For 3RV19 13-... enclosures and front plates

For 3 padlocks with max. 8 mm shackle diameter.

Cannot be used in combination with EMERGENCY-STOP mushroom button

IP55

S00

▶

3RV19 13-6B

1

1 unit

101

0.074

Spare actuator diaphragms

Holders and screws are included in scope of supply

IP55

S00

A

3RV19 13-7F

1

1 unit

101

0.023

Version	Rated control supply voltage U_s V	For motor starter protectors Size	DT	Order No.	Price per PU	PU (UNIT, SET, M)	PS*	PG	Weight per PU approx. kg
---------	---	-----------------------------------	----	-----------	--------------	-------------------	-----	----	-----------------------------

Indicator lights



3RV19 03-5B

Indicator lights

For all enclosures and front plates

With glow lamp and colored lenses red, green, yellow-, orange and clear

110 ... 120

220 ... 240

380 ... 415

480 ... 500

S00, S0, S2

C

3RV19 03-5B

1

1 unit

101

0.027

3RV19 03-5C

1

1 unit

101

0.026

3RV19 03-5E

1

1 unit

101

0.026

3RV19 03-5G

1

1 unit

101

0.027

3RV Molded Case Motor Starter Protectors up to 800 A

General data

Overview



3RV10 63-7AL10 molded case motor starter protectors

The 3RV10 and 3RV13 molded case motor starter protectors for up to 800 A are compact, current-limiting motor starter protectors which can be used above all in load feeders for special voltages of 440 V, 480 V, 550 V and 690 V. They are used for switching and protecting induction motors and other loads with rated currents up to 800 A.

Type of construction

The molded case motor starter protectors are available in 4 widths:

- 3RV13 53 – width 90 mm, max. rated current 32 A, at 400 V AC suitable for induction motors up to 22 kW.
- 3RV1. 6 – width 105 mm, max. rated current 250 A, at 400 V AC suitable for induction motors up to 110 kW.
- 3RV1. 7 – width 140 mm, max. rated current 630 A, at 400 V AC suitable for induction motors up to 200 kW.
- 3RV1. 83 – width 210 mm, max. rated current 800 A, at 400 V AC suitable for induction motors up to 355 kW.

The 3RV1 molded case motor starter protectors for up to 800 A can be mounted in horizontal, vertical or lying arrangement directly on a mounting plate or mounting rail. Their rated data are not affected by the mounting method.

The phase barriers for better insulation between the phases are included in the scope of supply.

The motor starter protectors can be supplied through top and bottom terminals without impairing their function, enabling them to be installed in any type of switchgear without any further steps.

Note



The 3RV1 molded case motor starter protectors for up to 800 A are suitable solely for screw connection. This is indicated in the selection and ordering data by orange backgrounds.

Benefits

- High short-circuit breaking capacity in the feeder
- Optimum usability in load feeders for the special voltages 440 V, 480 V, 550 V and 690 V
- Compact design
- The trip units are available both in purely magnetic (up to 32 A) and in solid-state versions (100 A to 800 A).

Application

Operating conditions

The 3RV1 molded case motor starter protectors for up to 800 A can be operated at ambient temperatures between -25 °C and +70 °C. They can be used according to IEC 60721-2-1 in the most difficult environmental conditions with a hot and damp climate.

Since operational currents, starting currents and current peaks are different even for motors with identical power ratings due to the inrush current, the motor ratings in the selection tables are only guide values. The specific rated and start-up data of the motor to be protected is always paramount to the choice of the most suitable molded case motor starter protectors.

Possible uses

The 3RV1 molded case motor starter protectors for up to 800 A are suitable as switching and protection devices for motors. The following versions are available:

- For motor protection; the overload and short-circuit releases are designed for optimized protection and direct starting of induction squirrel-cage motors. The motor starter protectors have an electronic trip unit which not only provides short-circuit and overload protection but is also sensitive to phase failure and phase unbalance and offers protection in the event of rotor blockage.
- For starter combinations; these molded case motor starter protectors are used for short-circuit protection in combinations of motor starter protector, motor contactor and overload relay. They are equipped with a purely magnetic trip unit (up to 32 A) or in solid-state trip unit (100 A to 800 A).

Standards and specifications

The electronic trip units for motor protection comply with IEC 60947-4-1. Isolating features are also compliant with IEC 60947-2.

The 3RV1 molded case motor starter protectors comply in addition with IEC 60068-2-6 (shock and vibration strength) and are certified for the specifications of the most important marine classification societies:





- RINA
- Det Norske Veritas
- Bureau Veritas
- Lloyds Register of Shipping
- Germanischer Lloyd
- American Bureau of Shipping

3RV Molded Case Motor Starter Protectors up to 800 A

For motor protection

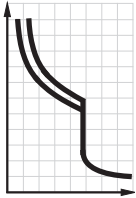
Selection and ordering data

CLASS 10A, CLASS 10, CLASS 20, CLASS 30, without auxiliary switches

	Rated current	Current setting of the inverse-time delayed overload release "L" I_R	Operating current of the instantaneous short-circuit releases "I" I_I	Short-circuit breaking capacity at 400 V AC	DT	Screw terminals		PU (UNIT, SET, M)	PS*	PG	Weight per PU approx.
	I_n			I_{cu}		Order No.	Price per PU				kg
	A	A	A	kA							

With electronic trip units



3RV10 .3-7.L10

TU = trip unit

Standard switching capacity, adjustable short-circuit and overload release, TU 4

100	40 ... 100	600 ... 1 300	120	X	3RV10 63-7AL10	1	1 unit	101	2.350
160	64 ... 160	960 ... 2 080	120	X	3RV10 63-7CL10	1	1 unit	101	2.350
200	80 ... 200	1 200 ... 2 600	120	X	3RV10 63-7DL10	1	1 unit	101	2.350
400	160 ... 400	2 400 ... 5 200	120	X	3RV10 73-7GL10	1	1 unit	101	3.250
630	252 ... 630	3 780 ... 8 190	100	X	3RV10 83-7JL10	1	1 unit	101	9.500

Auxiliary switches can be ordered separately (see "Mountable accessories").



3RV Molded Case Motor Starter Protectors up to 800 A

For starter combinations

Selection and ordering data

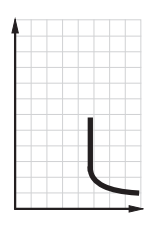
Without auxiliary switches



Rated current	Inverse-time delayed overload release "L" I_R	Operating current of the instantaneous short-circuit releases I_i	Short-circuit breaking capacity at 400 V AC	DT	Screw terminals	PU (UNIT, SET, M)	PS*	PG	Weight per PU approx.
I_n			I_{cu}		Order No.	Price per PU			kg
A	A	A	kA						

With magnetic trip units



3RV13 53-6.P10

Standard switching capacity, non-adjustable short-circuit release, TU 1

1	Without	13	85	X	3RV13 53-6AP10	1	1 unit	101	1.100
1.6	Without	21	85	X	3RV13 53-6BP10	1	1 unit	101	1.100
2	Without	26	85	X	3RV13 53-6CP10	1	1 unit	101	1.100
3.2	Without	42	85	X	3RV13 53-6DP10	1	1 unit	101	1.100
4	Without	52	85	X	3RV13 53-6EP10	1	1 unit	101	1.100
5	Without	65	85	X	3RV13 53-6FP10	1	1 unit	101	1.100
6.5	Without	85	85	X	3RV13 53-6GP10	1	1 unit	101	1.100
8.5	Without	111	85	X	3RV13 53-6HP10	1	1 unit	101	1.100
12.5	Without	163	85	X	3RV13 53-6JP10	1	1 unit	101	1.100
20	Without	120 ... 240	85	X	3RV13 53-6LM10	1	1 unit	101	1.100
32	Without	192 ... 384	85	X	3RV13 53-6MM10	1	1 unit	101	1.100

Standard switching capacity, adjustable short-circuit release, TU 2

With electronic trip units



3RV13 ...-7.N10

Standard switching capacity, adjustable short-circuit release, TU 3

100	Without	100 ... 1 000	120	X	3RV13 63-7AN10	1	1 unit	101	2.350
160	Without	160 ... 1 600	120	X	3RV13 63-7CN10	1	1 unit	101	2.350
250	Without	250 ... 2 500	120	X	3RV13 63-7EN10	1	1 unit	101	2.350
400	Without	400 ... 4 000	120	X	3RV13 73-7GN10	1	1 unit	101	3.250
630	Without	630 ... 6 300	120	X	3RV13 73-7JN10	1	1 unit	101	3.250
630	Without	630 ... 6 300	100	X	3RV13 83-7JN10	1	1 unit	101	9.500
800	Without	800 ... 8 000	100	X	3RV13 83-7KN10	1	1 unit	101	9.500
100	Without	100 ... 1 000	200	X	3RV13 64-7AN10	1	1 unit	101	2.350
160	Without	160 ... 1 600	200	X	3RV13 64-7CN10	1	1 unit	101	2.350
250	Without	250 ... 2 500	200	X	3RV13 64-7EN10	1	1 unit	101	2.350
400	Without	400 ... 4 000	200	X	3RV13 74-7GN10	1	1 unit	101	3.250

Increased switching capacity, adjustable short-circuit release, TU 3

TU = trip unit

Auxiliary switches can be ordered separately (see "Mountable accessories").

More information

Brochure "SIRIUS Configuration"

More information and assignment tables can be found in the brochure "SIRIUS Configuration", Order No. E86060-T1815-A101-A2-7600

or on the Internet under:

<http://www.siemens.com/lowvoltage/infomaterial>

--> "Brochures" --> "SIRIUS Modular System"

3RV Molded Case Motor Starter Protectors up to 800 A

Accessories

Mountable accessories

Selection and ordering data

Type	Version	For molded case motor starter protectors	DT	Screw terminals 	PU (UNIT, SET, M)	PS*	PG	Weight per PU approx.
				Order No.	Price per PU		kg	

Auxiliary switches



3RV19 91-1AA0

Auxiliary switches for front mounting	1 signal switch Off-On + 1 "tripped" signal (250 V AC/DC)	3RV13 53, 3RV1. 6. ... 3RV1. 83	X	3RV19 91-1AA0	1	1 unit	101	0.040
	3 signal switches Off-On + 1 "tripped" signal (250 V AC/DC)	...	X	3RV19 91-1BA0	1	1 unit	101	0.040
	3 signal switches Off-On + 1 "tripped" signal (24 V DC)	...	X	3RV19 91-1CA0	1	1 unit	101	0.040
Connection cables for auxiliary switches	Length 2 m, 6-pole	3RV13 53, 3RV1. 6. ... 3RV1. 83	X	3RV19 91-1FA0	1	1 unit	101	0.090

Type	Rated control supply voltage U_s		For molded case motor starter protectors	DT	Screw terminals 	PU (UNIT, SET, M)	PS*	PG	Weight per PU approx.
				Order No.	Price per PU		kg		

V

V

Auxiliary trip units



3RV19 52-1AA0

Undervoltage trip units For front mounting	24 ... 30	24 ... 30	3RV13 53	X	3RV19 52-1AA0	1	1 unit	101	0.120
	110 ... 127	110 ... 125	...	X	3RV19 52-1AD0	1	1 unit	101	0.120
	220 ... 240	220 ... 250	...	X	3RV19 52-1AE0	1	1 unit	101	0.120
	24 ... 30	24 ... 30	3RV1. 6.	X	3RV19 82-1AA0	1	1 unit	101	0.170
	110 ... 127	110 ... 125	...	X	3RV19 82-1AD0	1	1 unit	101	0.170
	220 ... 240	220 ... 250	3RV1. 83	X	3RV19 82-1AF0	1	1 unit	101	0.170

Shunt trip units



3RV19 52-1EA0

Shunt trip units For front mounting	24 ... 30	24 ... 30	3RV13 53	X	3RV19 52-1EA0	1	1 unit	101	0.120
	110 ... 127	110 ... 125	...	X	3RV19 52-1ED0	1	1 unit	101	0.120
	220 ... 240	220 ... 250	...	X	3RV19 52-1EF0	1	1 unit	101	0.120
	24 ... 30	24 ... 30	3RV1. 6.	X	3RV19 82-1EA0	1	1 unit	101	0.170
	110 ... 127	110 ... 125	...	X	3RV19 82-1ED0	1	1 unit	101	0.170
	220 ... 240	220 ... 250	3RV1. 83	X	3RV19 82-1EF0	1	1 unit	101	0.170





Connection cables for undervoltage and shunt trip units	Length 2 m, 6-pole	3RV13 53, 3RV1. 6. ... 3RV1. 83	X	3RV19 92-1FA0	1	1 unit	101	0.030
--	--------------------	---------------------------------	---	----------------------	---	--------	-----	-------

3RV Molded Case Motor Starter Protectors up to 800 A

Accessories

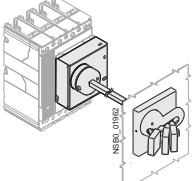
Rotary operating mechanisms
Mounting accessories

Selection and ordering data

Version	For molded case motor starter protectors	DT	Screw terminals 	PU (UNIT, SET, M)	PS*	PG	Weight per PU approx.		
			Order No.	Price per PU				kg	
Rotary operating mechanisms									
 <p>3RV19 .6-0BA0</p>	Lever-type rotary operating mechanisms	With adjustable distance,	3RV13 53	X	3RV19 56-0BA0	1	1 unit	101	0.400
		with lock/door interlocking (padlocks are not included in scope of supply)	3RV1. 6., 3RV1. 7.	X	3RV19 76-0BA0	1	1 unit	101	0.600
			3RV1. 83	X	3RV19 86-0BA0	1	1 unit	101	0.600
Connections									
 <p>3RV19 75-1CA0</p>	Connections	Front-extended (1 set = 6 units)	3RV13 53	X	3RV19 55-1AA0	1	1 unit	101	0.300
			3RV1. 6.	X	3RV19 65-1BA0	1	1 unit	101	0.600
			3RV1. 7.	X	3RV19 75-1CA0	1	1 unit	101	0.900
			3RV1. 83-7J.10	X	3RV19 85-1DA0	1	1 unit	101	0.782
			3RV1. 83-7KN10	X	3RV19 85-1EA0	1	1 unit	101	1.015
 <p>3RV19 55-3AA0</p>		Rear (1 set = 3 units)	3RV13 53	X	3RV19 55-3AA0	1	1 unit	101	0.200
			3RV1. 6.	X	3RV19 65-3AA0	1	1 unit	101	0.300
			3RV1. 7.	X	3RV19 75-3AA0	1	1 unit	101	1.000
			3RV1. 83	X	3RV19 85-3AA0	1	1 unit	101	1.000
 <p>3RV19 75-2AA0</p>	Cable terminals	Front-extended (1 set = 6 units)	3RV13 53	X	3RV19 55-2AA0	1	1 unit	101	0.150
			3RV1. 6.	X	3RV19 65-2BA0	1	1 unit	101	0.300
			3RV1. 7.-7G.10	X	3RV19 75-2CA0	1	1 unit	101	0.730
			3RV1. 73-7JN10	X	3RV19 75-2DA0	1	1 unit	101	0.750

Overview



Features	Benefits	3RU11	3RB20/3RB21	3RB22/3RB23
General data				
Sizes	<ul style="list-style-type: none"> Are coordinated with the dimensions, connections and technical characteristics of the other devices in the SIRIUS modular system (contactors, soft starters, ...) Permit the mounting of slim and compact load feeders in widths of 45 mm (S00), 45 mm (S0), 55 mm (S2), 70 mm (S3), 120 mm (S6) and 145 mm (S10/S12) Simplify configuration 	S00 ... S3	S00 ... S12	S00 ... S12
Seamless current range	<ul style="list-style-type: none"> Allows easy and consistent configuration with one series of overload relays (for small to large loads) 	0.11 ... 100 A	0.1 ... 630 A	0.3 ... 630 A (... 820 A) ¹⁾
Protection functions				
Tripping in the event of overload	<ul style="list-style-type: none"> Provides optimum inverse-time delayed protection of loads against excessive temperature rises due to overload 	✓	✓	✓
Tripping in the event of phase unbalance	<ul style="list-style-type: none"> Provides optimum inverse-time delayed protection of loads against excessive temperature rises due to phase unbalance 	(✓)	✓	✓
Tripping in the event of phase failure	<ul style="list-style-type: none"> Minimizes heating of induction motors during phase failure 	✓	✓	✓
Protection of single-phase loads	<ul style="list-style-type: none"> Enables the protection of single-phase loads 	✓	--	✓
Tripping in the event of overheating	<ul style="list-style-type: none"> Provides optimum temperature-dependent protection of loads against excessive temperature rises, e. g. for stator-critical motors or in the event of insufficient coolant flow, contamination of the motor surface or for long starting or braking operations Eliminates the need for additional special equipment Saves space in the control cabinet Reduces wiring outlay and costs 	-- ²⁾	-- ²⁾	✓
Integrated thermistor motor protection function				
Tripping in the event of a ground fault	<ul style="list-style-type: none"> Provides optimum protection of loads against high-resistance short-circuits or ground faults due to moisture, condensed water, damage to the insulation material, etc. 	--	✓ (only 3RB21)	✓
Internal ground-fault detection (activatable)	<ul style="list-style-type: none"> Eliminates the need for additional special equipment Saves space in the control cabinet Reduces wiring outlay and costs 			
Features				
RESET function	<ul style="list-style-type: none"> Allows manual or automatic resetting of the relay 	✓	✓	✓
Remote RESET function	<ul style="list-style-type: none"> Allows the remote resetting of the relay 	✓ (by means of separate module)	✓ (only 3RB21 with 24 V DC)	✓
TEST function for auxiliary contacts	<ul style="list-style-type: none"> Allows easy checking of the function and wiring 	✓	✓	✓
TEST function for electronics	<ul style="list-style-type: none"> Allows checking of the electronics 	--	✓	✓
Status display	<ul style="list-style-type: none"> Displays the current operating state 	✓	✓	✓
Large current adjustment button	<ul style="list-style-type: none"> Makes it easier to set the relay exactly to the correct current value 	✓	✓	✓
Integrated auxiliary contacts (1 NO + 1 NC)	<ul style="list-style-type: none"> Allows the load to be switched off if necessary Can be used to output signals 	✓	✓	✓ (2 ×)

¹⁾ Motor currents up to 820 A can be recorded and evaluated by a current measuring module, e. g. 3RB29 06-2BG1 (0.3 ... 3 A), in combination with a 3UF18 68-3GA00 (820 A / 1 A) series transformer.
For 3UF18 transformers, see Chapter 7, section "SIMOCODE".

²⁾ The SIRIUS 3RN thermistor motor protection devices can be used to provide additional temperature-dependent protection.

Overload Relays

General data



Features	Benefits	3RU11	3RB20/3RB21	3RB22/3RB23
Design of load feeders				
Short-circuit strength up to 100 kA at 690 V (in conjunction with the corresponding fuses or the corresponding motor starter protector)	<ul style="list-style-type: none"> Provides optimum protection of the loads and operating personnel in the event of short-circuits due to insulation faults or faulty switching operations 	✓	✓	✓
Electrical and mechanical matching to 3RT1 contactors	<ul style="list-style-type: none"> Simplifies configuration Reduces wiring outlay and costs Enables stand-alone installation as well as space-saving direct mounting 	✓	✓	✓ ¹⁾
Straight-through transformers for main circuit²⁾ (in this case the cables are routed through the feed-through openings of the overload relay and connected directly to the box terminals of the contactor)	<ul style="list-style-type: none"> Reduces the contact resistance (only one point of contact) Saves wiring costs (easy, no need for tools, and fast) Saves material costs Reduces installation costs 	--	✓ (S2 ... S6)	✓ (S00 ... S6)
Spring-loaded terminal connection system for main circuit²⁾	<ul style="list-style-type: none"> Enables fast connections Permits vibration-resistant connections Enables maintenance-free connections 	✓ (S00)	--	--
Spring-loaded terminal connection system for auxiliary circuits²⁾	<ul style="list-style-type: none"> Enables fast connections Permits vibration-resistant connections Enables maintenance-free connections 	✓	✓	✓
Other features				
Temperature compensation	<ul style="list-style-type: none"> Allows the use of the relays at high temperatures without derating Prevents premature tripping Allows compact installation of the control cabinet without distance between the devices/load feeders Simplifies configuration Enables space to be saved in the control cabinet 	✓	✓	✓
Very high long-term stability	<ul style="list-style-type: none"> Provides safe protection for the loads even after years of use in severe operating conditions 	✓ ^(✓)	✓	✓
Wide setting ranges	<ul style="list-style-type: none"> Reduce the number of variants Minimize the engineering outlay and costs Minimize storage overhead, storage costs, tied-up capital 	--	✓ (1:4)	✓ (1:10)
Trip class CLASS 5	<ul style="list-style-type: none"> Enables solutions for very fast starting motors requiring special protection (e. g. Ex motors) 	--	✓ (only 3RB21)	✓
Trip classes > CLASS 10	<ul style="list-style-type: none"> Enables heavy starting solutions 	--	✓	✓
Low power loss	<ul style="list-style-type: none"> Reduces power consumption and energy costs (up 98 % less power is used than for thermal overload relays). Minimizes temperature rises of the contactor and control cabinet – in some cases this may eliminate the need for controlgear cabinet cooling. Direct mounting to contactor saves space, even for high motor currents (i. e. no heat decoupling is required). 	--	✓	✓

¹⁾ Exception: up to size S3, only stand-alone installation is possible.

²⁾ Alternatively available for screw terminals.



Features	Benefits	3RU11	3RB20/3RB21	3RB22/3RB23
Other features				
Internal power supply	<ul style="list-style-type: none"> Eliminates the need for configuration and connecting an additional control circuit 	-- ¹⁾	✓	--
Variable adjustment of the trip classes (The required trip class can be adjusted by means of a rotary switch depending on the current start-up condition.)	<ul style="list-style-type: none"> Reduces the number of variants Minimizes the configuring outlay and costs Minimizes storage overhead, storage costs, and tied-up capital 	--	✓ (only 3RB21)	✓
Overload warning	<ul style="list-style-type: none"> Indicates imminent tripping of the relay directly on the device due to overload, phase unbalance or phase failure Allows the imminent tripping of the relay to be signaled Allows measures to be taken in time in the event of continuous inverse-time delayed overloads Eliminates the need for an additional device Saves space in the control cabinet Reduces wiring outlay and costs 	--	--	✓
Analog output	<ul style="list-style-type: none"> Allows the output of an analog output signal for actuating moving-coil instruments, feeding programmable logic controllers or transfer to bus systems Eliminates the need for an additional measuring transducer and signal converter Saves space in the control cabinet Reduces wiring outlay and costs 	--	--	✓

¹⁾ The SIRIUS 3RU11 thermal overload relays use a bimetal contactor and therefore do not require a control supply voltage.

Overload Relays

General data

Overload relays	Current measurement	Current range	Contactors (type, size, rating in kW)							
			3RT10 1	3RT10 2	3RT10 3	3RT10 4	3RT10 5	3RT10 6	3RT10 7	3TF68/69
Type	Type	A	S00 3/4/5.5	S0 5.5/7.5/11	S2 15/18.5/22	S3 30/37/45	S6 55/75/90	S10 110/132/160	S12 200/250	Size 14 375/450

3RU11 thermal overload relays



3RU11 1	Integrated	0.11 ... 12	✓	--	--	--	--	--	--	--
3RU11 2	Integrated	1.8 ... 25	--	✓	--	--	--	--	--	--
3RU11 3	Integrated	5.5 ... 50	--	--	✓	--	--	--	--	--
3RU11 4	Integrated	18 ... 100	--	--	--	✓	--	--	--	--

3RB20¹⁾ solid-state overload relays



3RB20 1	Integrated	0.1 ... 12	✓	--	--	--	--	--	--	--
3RB20 2	Integrated	0.1 ... 25	--	✓	--	--	--	--	--	--
3RB20 3	Integrated	6 ... 50	--	--	✓	--	--	--	--	--
3RB20 4	Integrated	12.5 ... 100	--	--	--	✓	--	--	--	--
3RB20 5	Integrated	50 ... 200	--	--	--	--	✓	--	--	--
3RB20 6	Integrated	55 ... 630	--	--	--	--	--	✓	✓	✓
3RB20 1 + 3UF18	Integrated	630 ... 820	--	--	--	--	--	--	--	✓

3RB21¹⁾ solid-state overload relays



3RB21 1	Integrated	0.1 ... 12	✓	--	--	--	--	--	--	--
3RB21 2	Integrated	0.1 ... 25	--	✓	--	--	--	--	--	--
3RB21 3	Integrated	6 ... 50	--	--	✓	--	--	--	--	--
3RB21 4	Integrated	12.5 ... 100	--	--	--	✓	--	--	--	--
3RB21 5	Integrated	50 ... 200	--	--	--	--	✓	--	--	--
3RB21 6	Integrated	55 ... 630	--	--	--	--	--	✓	✓	✓
3RB21 1 + 3UF18	Integrated	630 ... 820	--	--	--	--	--	--	--	✓

3RB22/3RB23¹⁾ solid-state overload relays



3RB22/3RB23 +	3RB29 0	0.3 ... 25	✓	✓	--	--	--	--	--	--
	3RB29 0	10 ... 100	--	--	✓	✓	--	--	--	--
	3RB29 5	20 ... 200	--	--	--	--	✓	--	--	--
	3RB29 6	63 ... 630	--	--	--	--	--	✓	✓	✓
	3RB29 0 + 3UF18	630 ... 820	--	--	--	--	--	--	--	✓

¹⁾ When using the overload relays with trip class \geq CLASS 20, see Technical Information LV 1 T "Technical specifications", "Short-Circuit Protection with Fuses for Motor Feeders", and the project planning aid "Configuring SIR-IUS Fuseless Load Feeders".

Connection methods

The 3RB20 and 3RB21 relays are available with screw terminals (box terminals) or spring-loaded terminals on the auxiliary current side; the same applies for the evaluation modules of the 3RB22/3RB23 relays. The 3RU11 relays come with screw terminals.



Screw terminals



Spring-type terminals or Cage Clamp terminals

The terminals are indicated in the selection and ordering data by orange backgrounds.

Overload Relays

3RU1 Thermal Overload Relays

3RU11 for standard applications

Overview

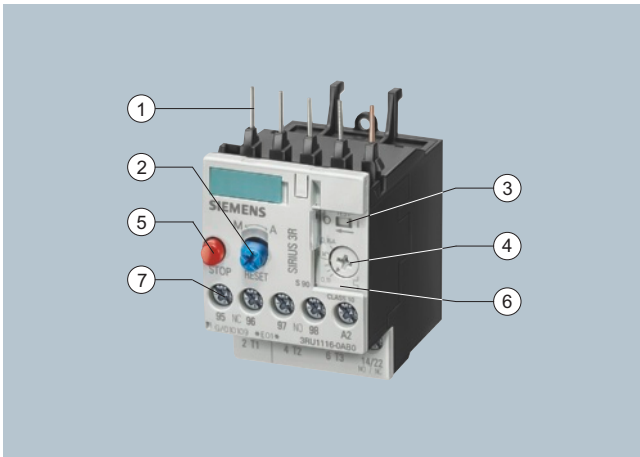

- (1) Connection for mounting onto contactors:
Optimally adapted in electrical, mechanical and design terms to the contactors, these connecting pins can be used for direct mounting of the overload relays. Stand-alone installation is possible as an alternative (in some cases in conjunction with a stand-alone installation module).
- (2) Selector switch for manual/automatic RESET and RESET button:
With this switch you can choose between manual and automatic RESET. A device set to manual RESET can be reset locally by pressing the RESET button. A remote RESET is possible using the RESET modules (accessories), which are independent of size.
- (3) Switch position indicator and TEST function of the wiring:
Indicates a trip and enables the wiring test.
- (4) Motor current setting:
Setting the device to the rated motor current is easy with the large rotary knob.
- (5) STOP button:
If the STOP button is pressed, the NC contact is opened. This switches off the contactor downstream. The NC contact is closed again when the button is released.
- (6) Transparent, sealable cover:
Secures the motor current setting and the TEST function against adjustment.
- (7) Supply terminals:
The generously sized terminals permit connection of two conductors with different cross-sections for the main and auxiliary circuits. The auxiliary circuit can be connected with screw terminals and alternatively with spring-loaded terminals.

The 3RU11 thermal overload relays up to 100 A have been designed for inverse-time delayed protection of loads with normal starting (see [Technical Information LV 1 T, "Function"](#)) against excessive temperature rises due to overload or phase failure. An overload or phase failure results in an increase of the motor current beyond the set rated motor current. Via heating elements, this current rise heats up the bimetal strips inside the device which then bend and as a result trigger the auxiliary contacts by means of a tripping mechanism. The auxiliary contacts then switch off the load by means of a contactor. The break time depends on the ratio between the tripping current and current setting I_{tr} and is stored in the form of a long-term stable tripping characteristic (see [Technical Information LV 1 T, "Characteristic Curves"](#)).

The "tripped" status is signaled by means of a switch position indicator. Resetting takes place either manually or automatically after a recovery time has elapsed (see [Technical Information LV 1 T, "Function"](#)).

The devices are manufactured in accordance with environmental guidelines and contain environmentally friendly and reusable materials.

They comply with all important worldwide standards and approvals.

"Increased safety" type of protection EEx e according to ATEX directive 94/9/EC

The 3RU11 thermal overload relays are suitable for the overload protection of explosion-proof motors with "increased safety" type of protection EEx e. The relays meet the requirements of EN 60079-7 (Electrical apparatus for areas subject to explosion hazards – Increased safety "e"); see [Chapter 20 "Appendix" --> "Standards and approvals" --> "Type overview of approved devices for potentially explosive areas \(ATEX explosion protection\)"](#).

EC type test certificate for Category (2) G/D exists. It has the number DMT 98 ATEX G 001.

Benefits

The most important features and benefits of the 3RU11 thermal overload relays are listed in the overview table (see ["Overload Relays"](#), --> "General data").

Application

Industries

The 3RU11 thermal overload relays are suitable for customers from all industries who want to guarantee optimum inverse-time delayed protection of their electrical loads (e. g. motors) under normal starting conditions (CLASS 10).

Application

The 3RU11 thermal overload relays have been designed for the protection of three-phase and single-phase AC and DC motors.

If single-phase AC or DC loads are to be protected by the 3RU11 thermal overload relays, all three bimetal strips must be heated. For this purpose, all main current paths of the relay must be connected in series.

Ambient conditions

The 3RU11 thermal overload relays have temperature compensation in accordance with IEC 60947-4-1 for the temperature range of -20 to $+60$ °C. For temperatures from $+60$ to $+80$ °C the upper set value of the setting range must be reduced by the factor listed in the table below.

Ambient temperature in °C	Derating factor for the upper set value
+60	1.0
+65	0.94
+70	0.87
+75	0.81
+80	0.73

Overload Relays

3RU1 Thermal Overload Relays





3RU11 for standard applications

Selection and ordering data

3RU11 thermal overload relays with screw terminals on the auxiliary current side¹⁾ for direct mounting, CLASS 10

Features and technical specifications:

- Overload and phase failure protection
- Auxiliary contacts 1 NO + 1 NC
- Manual and automatic RESET
- Switch position indicators
- TEST function
- STOP button
- Integrated, sealable cover

Size	Size contactor ²⁾	Rating for induction motor Rated value ³⁾	Current setting of the inverse-time delayed overload release	Short-circuit protection with fuse, type of coordination 2, gL/gG operational class ⁴⁾	DT	Screw terminals (on auxiliary current side)		PU (UNIT, SET, M)	PS*	PG	Weight per PU approx.
						Order No.	Price per PU				
		kW	A	A							kg
Size S00											
	S00	0.04	0.11 ... 0.16	0.5	▶	3RU11 16-0AB0		1	1 unit	101	0.150
		0.06	0.14 ... 0.2	1	▶	3RU11 16-0BB0		1	1 unit	101	0.150
		0.06	0.18 ... 0.25	1	▶	3RU11 16-0CB0		1	1 unit	101	0.150
		0.09	0.22 ... 0.32	1.6	▶	3RU11 16-0DB0		1	1 unit	101	0.150
		0.09	0.28 ... 0.4	2	▶	3RU11 16-0EB0		1	1 unit	101	0.150
		0.12	0.35 ... 0.5	2	▶	3RU11 16-0FB0		1	1 unit	101	0.150
		0.18	0.45 ... 0.63	2	▶	3RU11 16-0GB0		1	1 unit	101	0.150
		0.18	0.55 ... 0.8	4	▶	3RU11 16-0HB0		1	1 unit	101	0.150
		0.25	0.7 ... 1	4	▶	3RU11 16-0JB0		1	1 unit	101	0.150
		0.37	0.9 ... 1.25	4	▶	3RU11 16-0KB0		1	1 unit	101	0.150
		0.55	1.1 ... 1.6	6	▶	3RU11 16-1AB0		1	1 unit	101	0.150
		0.75	1.4 ... 2	6	▶	3RU11 16-1BB0		1	1 unit	101	0.150
		0.75	1.8 ... 2.5	10	▶	3RU11 16-1CB0		1	1 unit	101	0.150
		1.1	2.2 ... 3.2	10	▶	3RU11 16-1DB0		1	1 unit	101	0.150
		1.5	2.8 ... 4	16	▶	3RU11 16-1EB0		1	1 unit	101	0.150
		1.5	3.5 ... 5	20	▶	3RU11 16-1FB0		1	1 unit	101	0.150
		2.2	4.5 ... 6.3	20	▶	3RU11 16-1GB0		1	1 unit	101	0.150
3	5.5 ... 8	25	▶	3RU11 16-1HB0		1	1 unit	101	0.150		
4	7 ... 10	35	▶	3RU11 16-1JB0		1	1 unit	101	0.150		
5.5	9 ... 12	35	▶	3RU11 16-1KB0		1	1 unit	101	0.150		
Size S0											
	S0	0.75	1.8 ... 2.5	10	▶	3RU11 26-1CB0		1	1 unit	101	0.190
		1.1	2.2 ... 3.2	10	▶	3RU11 26-1DB0		1	1 unit	101	0.190
		1.5	2.8 ... 4	16	▶	3RU11 26-1EB0		1	1 unit	101	0.190
		1.5	3.5 ... 5	20	▶	3RU11 26-1FB0		1	1 unit	101	0.190
		2.2	4.5 ... 6.3	20	▶	3RU11 26-1GB0		1	1 unit	101	0.190
		3	5.5 ... 8	25	▶	3RU11 26-1HB0		1	1 unit	101	0.190
		4	7 ... 10	35	▶	3RU11 26-1JB0		1	1 unit	101	0.190
		5.5	9 ... 12.5	35	▶	3RU11 26-1KB0		1	1 unit	101	0.190
		7.5	11 ... 16	40	▶	3RU11 26-4AB0		1	1 unit	101	0.190
		7.5	14 ... 20	50	▶	3RU11 26-4BB0		1	1 unit	101	0.190
		11	17 ... 22	63	▶	3RU11 26-4CB0		1	1 unit	101	0.190
11	20 ... 25	63	▶	3RU11 26-4DB0		1	1 unit	101	0.190		
Size S2											
	S2	3	5.5 ... 8	25	▶	3RU11 36-1HB0		1	1 unit	101	0.320
		4	7 ... 10	35	▶	3RU11 36-1JB0		1	1 unit	101	0.320
		5.5	9 ... 12.5	35	▶	3RU11 36-1KB0		1	1 unit	101	0.320
		7.5	11 ... 16	40	▶	3RU11 36-4AB0		1	1 unit	101	0.320
		7.5	14 ... 20	50	▶	3RU11 36-4BB0		1	1 unit	101	0.320
		11	18 ... 25	63	▶	3RU11 36-4DB0		1	1 unit	101	0.320
		15	22 ... 32	80	▶	3RU11 36-4EB0		1	1 unit	101	0.320
		18.5	28 ... 40	80	▶	3RU11 36-4FB0		1	1 unit	101	0.320
		22	36 ... 45	100	▶	3RU11 36-4GB0		1	1 unit	101	0.320
		22	40 ... 50	100	▶	3RU11 36-4HB0		1	1 unit	101	0.320
Size S3											
	S3	11	18 ... 25	63	▶	3RU11 46-4DB0		1	1 unit	101	0.550
		15	22 ... 32	80	▶	3RU11 46-4EB0		1	1 unit	101	0.550
		18.5	28 ... 40	80	▶	3RU11 46-4FB0		1	1 unit	101	0.550
		22	36 ... 50	125	▶	3RU11 46-4HB0		1	1 unit	101	0.550
		30	45 ... 63	125	▶	3RU11 46-4JB0		1	1 unit	101	0.550
		37	57 ... 75	160	▶	3RU11 46-4KB0		1	1 unit	101	0.550
		45	70 ... 90	160	▶	3RU11 46-4LB0		1	1 unit	101	0.550
		45	80 ... 100 ⁵⁾	200	▶	3RU11 46-4MB0		1	1 unit	101	0.550

¹⁾ With the suitable terminal brackets (see "Accessories", page 5/47), the 3RU11 overload relays for direct mounting can also be installed as stand-alone units.

²⁾ Observe maximum rated operational current of the devices.

³⁾ Guide value for 4-pole standard motors at 50 Hz 400 V AC. The actual starting and rated data of the motor to be protected must be considered when selecting the units.

⁴⁾ Maximum protection by fuse for overload relay, type of coordination 2. For fuse values in conjunction with contactors, see Technical Information LV 1 T "Technical specifications" -> "Short-circuit protection with fuses/motor starter protectors for motor feeders".

⁵⁾ For overload relays > 100 A, see 3RB2.

Overload Relays





3RU1 Thermal Overload Relays

3RU11 for standard applications

3RU11 thermal overload relays with screw terminals on the auxiliary current side for stand-alone installation¹⁾, CLASS 10

Features and technical specifications:

- Overload and phase failure protection
- Auxiliary contacts 1 NO + 1 NC
- Manual and automatic RESET
- Switch position indicators
- TEST function
- STOP button
- Integrated, sealable cover

Size contactor ²⁾	Rating for induction motor Rated value ³⁾	Current setting of the inverse-time delayed over- load release	Short-circuit protection with fuse, type of coordi- nation 2, gL/gG opera- tional class ⁴⁾	DT	Screw terminals (on auxiliary current side)	PU (UNIT, SET, M)	PS*	PG	Weight per PU approx.	
					Order No.					Price per PU
kW		A	A						kg	
Size S00										
	S00	0.04	0.11 ... 0.16	0.5	B	3RU11 16-0AB1	1	1 unit	101	0.180
		0.06	0.14 ... 0.2	1	B	3RU11 16-0BB1	1	1 unit	101	0.180
		0.06	0.18 ... 0.25	1	B	3RU11 16-0CB1	1	1 unit	101	0.180
		0.09	0.22 ... 0.32	1.6	B	3RU11 16-0DB1	1	1 unit	101	0.180
		0.09	0.28 ... 0.4	2	▶	3RU11 16-0EB1	1	1 unit	101	0.180
		0.12	0.35 ... 0.5	2	▶	3RU11 16-0FB1	1	1 unit	101	0.180
		0.18	0.45 ... 0.63	2	▶	3RU11 16-0GB1	1	1 unit	101	0.180
		0.18	0.55 ... 0.8	4	▶	3RU11 16-0HB1	1	1 unit	101	0.180
		0.25	0.7 ... 1	4	▶	3RU11 16-0JB1	1	1 unit	101	0.180
		0.37	0.9 ... 1.25	4	▶	3RU11 16-0KB1	1	1 unit	101	0.180
		0.55	1.1 ... 1.6	6	▶	3RU11 16-1AB1	1	1 unit	101	0.180
		0.75	1.4 ... 2	6	▶	3RU11 16-1BB1	1	1 unit	101	0.180
		0.75	1.8 ... 2.5	10	▶	3RU11 16-1CB1	1	1 unit	101	0.180
		1.1	2.2 ... 3.2	10	▶	3RU11 16-1DB1	1	1 unit	101	0.180
		1.5	2.8 ... 4	16	▶	3RU11 16-1EB1	1	1 unit	101	0.180
		1.5	3.5 ... 5	20	▶	3RU11 16-1FB1	1	1 unit	101	0.180
		2.2	4.5 ... 6.3	20	▶	3RU11 16-1GB1	1	1 unit	101	0.180
	3	5.5 ... 8	25	▶	3RU11 16-1HB1	1	1 unit	101	0.180	
	4	7 ... 10	35	▶	3RU11 16-1JB1	1	1 unit	101	0.180	
	5.5	9 ... 12	35	▶	3RU11 16-1KB1	1	1 unit	101	0.180	
Size S0										
	S0	7.5	11 ... 16	40	▶	3RU11 26-4AB1	1	1 unit	101	0.240
		7.5	14 ... 20	50	▶	3RU11 26-4BB1	1	1 unit	101	0.240
		11	17 ... 22	63	▶	3RU11 26-4CB1	1	1 unit	101	0.240
		11	20 ... 25	63	▶	3RU11 26-4DB1	1	1 unit	101	0.240
Size S2										
	S2	15	22 ... 32	80	▶	3RU11 36-4EB1	1	1 unit	101	0.480
		18.5	28 ... 40	80	▶	3RU11 36-4FB1	1	1 unit	101	0.480
		22	36 ... 45	100	▶	3RU11 36-4GB1	1	1 unit	101	0.480
		22	40 ... 50	100	▶	3RU11 36-4HB1	1	1 unit	101	0.480
Size S3										
	S3	30	45 ... 63	125	▶	3RU11 46-4JB1	1	1 unit	101	0.810
		37	57 ... 75	160	▶	3RU11 46-4KB1	1	1 unit	101	0.810
		45	70 ... 90	160	▶	3RU11 46-4LB1	1	1 unit	101	0.810
		45	80 ... 100 ⁵⁾	200	▶	3RU11 46-4MB1	1	1 unit	101	0.810

¹⁾ Sizes S00 to S3 for screw and snap-on mounting onto TH 35 standard mounting rails, size S3 also for TH 75 standard mounting rails.

²⁾ Observe maximum rated operational current of the devices.

³⁾ Guide value for 4-pole standard motors at 50 Hz 400 V AC. The actual starting and rated data of the motor to be protected must be considered when selecting the units.

⁴⁾ Maximum protection by fuse for overload relay, type of coordination 2.

For fuse values in conjunction with contactors, see Technical Information LV 1 T "Technical specifications" -> "Short-circuit protection with fuses/motor starter protectors for motor feeders".

⁵⁾ For overload relays > 100 A, see 3RB2.

Overload Relays

3RU1 Thermal Overload Relays

3RU11 for standard applications

3RU11 thermal overload relays with Cage Clamp terminals for direct mounting¹⁾ and stand-alone installation²⁾, CLASS 10

Features and technical specifications:

- Overload and phase failure protection
- Auxiliary contacts 1 NO + 1 NC
- Manual and automatic RESET
- Switch position indicators
- TEST function
- STOP button
- Integrated, sealable cover

Size of contactor ³⁾	Rating for induction motor Rated value ⁴⁾	Current setting of the inverse-time delayed overload release	Short-circuit protection with fuse, type of coordination 2, gL/gG operational class ⁵⁾	DT	Cage Clamp terminals (on auxiliary current side)		PU (UNIT, SET, M)	PS*	PG	Weight per PU approx.
	kW	A	A		Order No.	Price per PU				kg

Size S00 for stand-alone installation⁶⁾

	3RU11 16-...C1	S00	0.04	0.11 ... 0.16	0.5	B	3RU11 16-0AC1		1	1 unit	101	0.190
		0.06	0.14 ... 0.2	1	B	3RU11 16-0BC1		1	1 unit	101	0.190	
		0.06	0.18 ... 0.25	1	B	3RU11 16-0CC1		1	1 unit	101	0.190	
		0.09	0.22 ... 0.32	1.6	B	3RU11 16-0DC1		1	1 unit	101	0.190	
		0.09	0.28 ... 0.4	2	B	3RU11 16-0EC1		1	1 unit	101	0.190	
		0.12	0.35 ... 0.5	2	B	3RU11 16-0FC1		1	1 unit	101	0.190	
		0.18	0.45 ... 0.63	2	▶	3RU11 16-0GC1		1	1 unit	101	0.190	
		0.18	0.55 ... 0.8	4	▶	3RU11 16-0HC1		1	1 unit	101	0.190	
		0.25	0.7 ... 1	4	▶	3RU11 16-0JC1		1	1 unit	101	0.190	
		0.37	0.9 ... 1.25	4	▶	3RU11 16-0KC1		1	1 unit	101	0.190	
		0.55	1.1 ... 1.6	6	▶	3RU11 16-1AC1		1	1 unit	101	0.190	
		0.75	1.4 ... 2	6	▶	3RU11 16-1BC1		1	1 unit	101	0.190	
		0.75	1.8 ... 2.5	10	C	3RU11 16-1CC1		1	1 unit	101	0.190	
		1.1	2.2 ... 3.2	10	▶	3RU11 16-1DC1		1	1 unit	101	0.190	
		1.5	2.8 ... 4	16	B	3RU11 16-1EC1		1	1 unit	101	0.190	
		1.5	3.5 ... 5	20	▶	3RU11 16-1FC1		1	1 unit	101	0.190	

Size S0 for direct mounting¹⁾⁷⁾

	3RU11 16-...D0	S0	0.75	1.8 ... 2.5	10	B	3RU11 26-1CD0		1	1 unit	101	0.190
		1.1	2.2 ... 3.2	10	B	3RU11 26-1DD0		1	1 unit	101	0.190	
		1.5	2.8 ... 4	16	B	3RU11 26-1ED0		1	1 unit	101	0.190	
		1.5	3.5 ... 5	20	B	3RU11 26-1FD0		1	1 unit	101	0.190	
		2.2	4.5 ... 6.3	20	B	3RU11 26-1GD0		1	1 unit	101	0.190	
		3	5.5 ... 8	25	B	3RU11 26-1HD0		1	1 unit	101	0.190	
		4	7 ... 10	35	B	3RU11 26-1JD0		1	1 unit	101	0.190	
		5.5	9 ... 12.5	35	B	3RU11 26-1KD0		1	1 unit	101	0.190	
		7.5	11 ... 16	40	▶	3RU11 26-4AD0		1	1 unit	101	0.190	
		7.5	14 ... 20	50	▶	3RU11 26-4BD0		1	1 unit	101	0.190	
		11	17 ... 22	63	▶	3RU11 26-4CD0		1	1 unit	101	0.190	
11	20 ... 25	63	▶	3RU11 26-4DD0		1	1 unit	101	0.190			

Size S2 for direct mounting¹⁾⁷⁾

	3RU11 36-...D0	S2	3	5.5 ... 8	25	B	3RU11 36-1HD0		1	1 unit	101	0.320
		4	7 ... 10	35	B	3RU11 36-1JD0		1	1 unit	101	0.320	
		5.5	9 ... 12.5	35	B	3RU11 36-1KD0		1	1 unit	101	0.320	
		7.5	11 ... 16	40	B	3RU11 36-4AD0		1	1 unit	101	0.320	
		7.5	14 ... 20	50	B	3RU11 36-4BD0		1	1 unit	101	0.320	
		11	18 ... 25	63	B	3RU11 36-4DD0		1	1 unit	101	0.320	
		15	22 ... 32	80	▶	3RU11 36-4ED0		1	1 unit	101	0.320	
		18.5	28 ... 40	80	▶	3RU11 36-4FD0		1	1 unit	101	0.320	
22	36 ... 45	100	▶	3RU11 36-4GD0		1	1 unit	101	0.320			
22	40 ... 50	100	▶	3RU11 36-4HD0		1	1 unit	101	0.320			

Size S3 for direct mounting¹⁾⁷⁾

	3RU11 46-...D0	S3	11	18 ... 25	63	B	3RU11 46-4DD0		1	1 unit	101	0.550
		15	22 ... 32	80	B	3RU11 46-4ED0		1	1 unit	101	0.550	
		18.5	28 ... 40	80	B	3RU11 46-4FD0		1	1 unit	101	0.550	
		22	36 ... 50	125	B	3RU11 46-4HD0		1	1 unit	101	0.550	
		30	45 ... 63	125	▶	3RU11 46-4JD0		1	1 unit	101	0.550	
		37	57 ... 75	160	▶	3RU11 46-4KD0		1	1 unit	101	0.550	
		45	70 ... 90	160	▶	3RU11 46-4LD0		1	1 unit	101	0.550	
		45	80 ... 100	200	▶	3RU11 46-4MD0		1	1 unit	101	0.550	

¹⁾ With the suitable terminal brackets (see "Accessories", page 5/47), the 3RU11 overload relays for direct mounting can also be installed as stand-alone units.

²⁾ Size S00 for screw and snap-on mounting onto TH 35 standard mounting rail.

³⁾ Observe maximum rated operational current of the devices.

⁴⁾ Guide value for 4-pole standard motors at 50 Hz 400 V AC. The actual starting and rated data of the motor to be protected must be considered when selecting the units.

⁵⁾ Maximum protection by fuse for overload relay, type of coordination 2. For fuse values in conjunction with contactors, see Technical Information LV 1 T "Technical specifications" -> "Short-circuit protection with fuses/motor starter protectors for motor feeders".

⁶⁾ Auxiliary and main conductor connections with Cage Clamp terminal.

⁷⁾ Auxiliary conductor connections with Cage Clamp terminals and main conductor connections with screw terminals.

Overload Relays

3RU1 Thermal Overload Relays

Accessories

Overview

The following optional accessories are available for the 3RU11 thermal overload relays:

- For the four overload relay sizes S00 to S3 one terminal bracket each for stand-alone installation
- One electrical remote RESET module in three voltage variants for all sizes
- One mechanical RESET module for all sizes
- One cable release for resetting devices which are difficult to access (for all sizes)
- Terminal covers

Selection and ordering data

Version	Size	DT	Order No.	Price per PU	PU (UNIT, SET, M)	PS*	PG	Weight per PU approx. kg
Terminal brackets for stand-alone installation								
	For separate mounting of overload relays; screw and snap-on mounting onto TH 35 standard mounting rail; size S3 also for TH 75 standard mounting rail	S00	▶ 3RU19 16-3AA01		1	1 unit	101	0.060
		S0	▶ 3RU19 26-3AA01		1	1 unit	101	0.080
		S2	▶ 3RU19 36-3AA01		1	1 unit	101	0.180
		S3	▶ 3RU19 46-3AA01		1	1 unit	101	0.280
Mechanical RESET¹⁾								
	Resetting plungers, holders and formers	S00 ...S3	▶ 3RU19 00-1A		1	1 unit	101	0.038
	Pushbuttons with extended stroke (12 mm), IP65, Ø 22 mm		B ▶ 3SB30 00-0EA11		1	1 unit	102	0.020
	Extension plungers For compensation of the distance between the pushbutton and the unlatching button of the relay		A ▶ 3SX1 335		1	1 unit	102	0.004
Cable releases with holder for RESET¹⁾								
	For Ø 6.5 mm holes in the control panel; max. control panel thickness 8 mm	S00 ...S3						
	• Length 400 mm • Length 600 mm		▶ 3RU19 00-1B ▶ 3RU19 00-1C		1 1	1 unit 1 unit	101 101	0.063 0.073
Modules for remote RESET, electrical								
	Operating range	24 ... 30 V	S00 ...S3	▶ 3RU19 00-2AB71	1	1 unit	101	0.066
	0.85 ... 1.1 x U _S ;	110 ... 127 V		▶ 3RU19 00-2AF71	1	1 unit	101	0.067
	power consumption AC: 80 VA, DC: 70 W; ON period 0.2 ... 4 s; switching frequency 60/h	220 ... 250 V		▶ 3RU19 00-2AM71	1	1 unit	101	0.066
Terminal covers¹⁾								
	Covers for cable lugs and busbar connections							
	• Length 55 mm	S3	▶ 3RT19 46-4EA1		1	1 unit	101	0.040
	Covers for box terminals							
	• Length 20.6 mm	S2	▶ 3RT19 36-4EA2		1	1 unit	101	0.020
	• Length 20.8 mm	S3	▶ 3RT19 46-4EA2		1	1 unit	101	0.025

For more accessories (screwdrivers and labeling plates), see page 5/62.

¹⁾ The accessories are identical to those of the 3RB2 solid-state overload relays.

Overload Relays

3RB2 Solid-State Overload Relays

3RB20, 3RB21 for standard applications

Overview

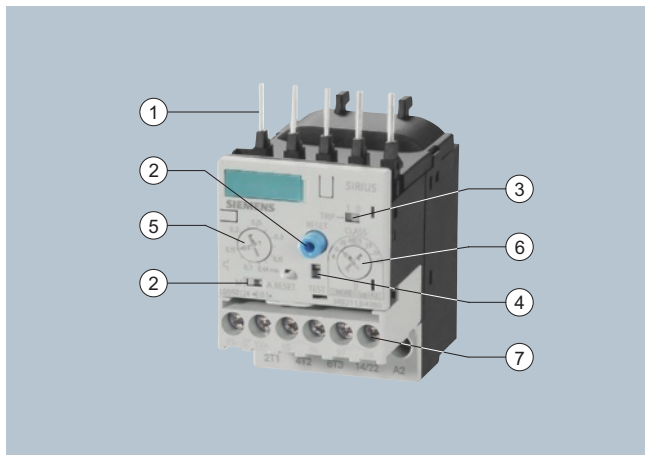

- (1) Connection for mounting onto contactors:
Optimally adapted in electrical, mechanical and design terms to the contactors and soft starters, these connecting pins can be used for direct mounting of the overload relays. Stand-alone installation is possible as an alternative (in some cases in conjunction with a stand-alone installation module).
- (2) Selector switch for manual/automatic RESET and RESET button:
With the slide switch you can choose between manual and automatic RESET. A device set to manual RESET can be reset locally by pressing the RESET button. On the 3RB21 a solid-state remote RESET is integrated.
- (3) Switch position indicator and TEST function of the wiring:
Indicates a trip and enables the wiring test.
- (4) Solid-state test (device test):
Enables a test of all important device components and functions.
- (5) Motor current setting:
Setting the device to the rated motor current is easy with the large rotary knob.
- (6) Trip class setting/internal ground-fault detection (only 3RB21):
Using the rotary switch you can set the required trip class and activate the internal ground-fault detection dependent on the start-up conditions.
- (7) Connecting terminals (removable joint block for auxiliary circuits):
The generously sized terminals permit connection of two conductors with different cross-sections for the main and auxiliary circuits. The auxiliary circuit can be connected with screw terminals and alternatively with spring-loaded terminals.

The 3RB20 and 3RB21 solid-state overload relays up to 630 A with internal power supply have been designed for inverse-time delayed protection of loads with normal and heavy starting (see [Technical Information LV 1 T, "Function"](#)) against excessive temperature rises due to overload, phase unbalance or phase failure. An overload, phase unbalance or phase failure result in an increase of the motor current beyond the set rated motor current. This current rise is detected by the current transformers integrated into the devices and evaluated by corresponding solid-state circuits which then output a pulse to the auxiliary contacts. The auxiliary contacts then switch off the load by means of a contactor. The break time depends on the ratio between the tripping current and current setting I_e and is stored in the form of a long-term stable tripping characteristic (see [Technical Information LV 1 T, "Characteristic Curves"](#)).

In addition to inverse-time delayed protection of loads against excessive temperature rises due to overload, phase unbalance and phase failure, the 3RB21 solid-state overload relays also allow internal ground-fault detection (not possible in conjunction with contactor assemblies for wye-delta starting). This provides protection of loads against high-resistance short-circuits due to damage to the insulation material, moisture, condensed water etc.

The "tripped" status is signaled by means of a switch position indicator. Resetting takes place either manually or automatically after the recovery time has elapsed (see [Technical Information LV 1 T, "Function"](#)).

The devices are manufactured in accordance with environmental guidelines and contain environmentally friendly and reusable materials. They comply with all important worldwide standards and approvals.

"Increased safety" type of protection EEx e according to ATEX directive 94/9/EC

The 3RB20/3RB21 solid-state overload relays are suitable for the overload protection of explosion-proof motors with "increased safety" type of protection EEx e. The relays meet the requirements of EN 60079-7 (Electrical apparatus for areas subject to explosion hazards – Increased safety "e");
See Chapter 20 "Appendix" --> "Standards and approvals" --> "Type overview of approved devices for potentially explosive areas (ATEX explosion protection)".

EC type test certificate for Group II, Category (2) G/D exists. It has the number PTB 06 ATEX 3001.

Benefits

The most important features and benefits of the 3RB20/3RB21 solid-state overload relays are listed in the overview table (see "Overload Relays" --> "General data", page 5/39).

Overload Relays

3RB2 Solid-State Overload Relays

3RB20, 3RB21 for standard applications

Application

Industries

The 3RB20/3RB21 solid-state overload relays are suitable for customers from all industries who want to guarantee optimum inverse-time delayed protection of their electrical loads (e. g. motors) under normal and heavy starting conditions (CLASS 5 to CLASS 30), minimize project completion times, inventories and power consumption, and optimize plant availability and maintenance management.

Application

The 3RB20/3RB21 solid-state overload relays have been designed for the protection of induction motors in sinusoidal 50/60 Hz voltage networks. The relays are not suitable for the protection of single-phase AC or DC loads.

The 3RU11 thermal overload relay or the 3RB22/3RB23 solid-state overload relay can be used for single-phase AC loads. For DC loads we recommend the 3RU11 thermal overload relay.

Ambient conditions

The devices are insensitive to external influences such as shocks, corrosive environments, ageing and temperature fluctuation.

For the temperature range from -25 °C to $+60\text{ °C}$, the 3RB20/3RB21 solid-state overload relays compensate the temperature according to IEC 60947-4-1.

For the 3RB20/3RB21 solid-state overload relays with the sizes S6, S10 and S12, the upper set value of the setting range must be reduced for ambient temperatures $> 50\text{ °C}$ by a certain factor (see tables below).

Type	Setting range	Derating factor for the upper set value for stand-alone installation at ambient temperature	
		+50 °C	+60 °C
3RB20 56, 3RB21 56	50 ... 200 A	100 %	100 %
3RB20 66, 3RB21 66	55 ... 250 A	100 %	100 %
3RB20 66, 3RB21 66	160 ... 630 A	100 %	90 %

Type	Setting range	Derating factor for the upper set value for mounting onto contactor at ambient temperature	
		+50 °C	+60 °C
3RB20 56, 3RB21 56	50 ... 200 A	100 %	70 %
3RB20 66, 3RB21 66	55 ... 250 A	100 %	70 %
3RB20 66, 3RB21 66	160 ... 630 A	100 %	70 %

Accessories

The following accessories are available for the 3RB20/3RB21 solid-state overload relays:

- One terminal bracket each for the overload relays size S00 and S0 (sizes S2 to S12 can be installed as stand-alone installation without a terminal bracket)
- One mechanical remote RESET module for all sizes
- One cable release for resetting devices which are difficult to access (for all sizes)
- One sealable cover for all sizes
- Box terminal blocks for sizes S6 and S10/S12
- Terminal covers for sizes S2 to S10/S12

Overload Relays

3RB2 Solid-State Overload Relays





3RB20, 3RB21 for standard applications

Selection and ordering data

3RB20 solid-state overload relays with screw terminals on auxiliary current side for direct mounting¹⁾²⁾ and stand-alone installation²⁾³⁾, CLASS 10

Features and technical specifications:

- Overload protection, phase failure protection and unbalance protection
- Internal power supply
- Auxiliary contacts 1 NO + 1 NC
- Manual and automatic RESET
- Switch position indicators
- TEST function and self-monitoring

Size contactor ⁴⁾	Rating for induction motor Rated value ⁵⁾	Current setting of the inverse- time delayed overload release	Short-circuit protection with fuse, type of coord- ination 2, gL/gG opera- tional class ⁶⁾	DT	Screw terminals (on auxiliary current side)		PU (UNIT, SET, M)	PS*	PG	Weight per PU approx.	
					Order No.	Price per PU					
	kW	A	A							kg	
Size S00¹⁾											
	S00	0.04 ... 0.09	0.1 ... 0.4	1	▶	3RB20 16-1RB0		1	1 unit	101	0.200
		0.12 ... 0.37	0.32 ... 1.25	2	▶	3RB20 16-1NB0		1	1 unit	101	0.200
		0.55 ... 1.5	1 ... 4	10	▶	3RB20 16-1PB0		1	1 unit	101	0.200
		1.1 ... 5.5	3 ... 12	20	▶	3RB20 16-1SB0		1	1 unit	101	0.200
Size S0¹⁾											
	S0	0.04 ... 0.09	0.1 ... 0.4	1	▶	3RB20 26-1RB0		1	1 unit	101	0.220
		0.12 ... 0.37	0.32 ... 1.25	2	▶	3RB20 26-1NB0		1	1 unit	101	0.220
		0.55 ... 1.5	1 ... 4	10	▶	3RB20 26-1PB0		1	1 unit	101	0.220
		1.1 ... 5.5	3 ... 12	20	▶	3RB20 26-1SB0		1	1 unit	101	0.220
		3 ... 11	6 ... 25	35	▶	3RB20 26-1QB0		1	1 unit	101	0.220
Size S2¹⁾³⁾⁷⁾											
	S2	3 ... 11	6 ... 25	63	▶	3RB20 36-1QB0		1	1 unit	101	0.360
		7.5 ... 22	12.5 ... 50	80	▶	3RB20 36-1QW1		1	1 unit	101	0.230
					▶	3RB20 36-1UB0		1	1 unit	101	0.360
				▶	3RB20 36-1UW1		1	1 unit	101	0.230	
Size S3¹⁾³⁾⁷⁾											
	S3	7.5 ... 22	12.5 ... 50	160	▶	3RB20 46-1UB0		1	1 unit	101	0.560
		11 ... 45	25 ... 100	315	▶	3RB20 46-1EB0		1	1 unit	101	0.560
					▶	3RB20 46-1EW1		1	1 unit	101	0.450
Size S6²⁾⁷⁾											
	S6 with busbar connec- tion	22 ... 90	50 ... 200	315	▶	3RB20 56-1FC2		1	1 unit	101	1.030
					▶	3RB20 56-1FW2		1	1 unit	101	0.690
Size S10/S12²⁾											
	S10/S12 and size 14 (3TF68/ 3TF69)	22 ... 110	55 ... 250	400	▶	3RB20 66-1GC2		1	1 unit	101	1.820
		90 ... 450	160 ... 630	800	▶	3RB20 66-1MC2		1	1 unit	101	1.820

¹⁾ The relays with an Order No. ending with "0" are designed for direct mounting. With the matching terminal brackets (see "Accessories", page 5/60) the sizes S00 and S0 can also be installed as stand-alone units.

²⁾ The relays with an Order No. ending with "2" are designed for direct mounting and stand-alone installation. For 3TF68/3TF69 contactors, direct mounting is not possible.

³⁾ The relays with an Order No. ending with "1" are designed for stand-alone installation.

⁴⁾ Observe maximum rated operational current of the devices.

⁵⁾ Guide value for 4-pole standard motors at 50 Hz 400 V AC. The actual starting and rated data of the motor to be protected must be considered when selecting the units.

⁶⁾ Maximum protection by fuse for overload relay, type of coordination 2. For fuse values in conjunction with contactors see Technical Information LV 1 T "Technical specifications"--> "Short-circuit protection with fuses for motor feeders".

⁷⁾ The relays with an Order No. with "W" in penultimate position are equipped with a straight-through transformer.

* You can order this quantity or a multiple thereof.







Overload Relays

3RB2 Solid-State Overload Relays

3RB20, 3RB21 for standard applications
3RB20 solid-state overload relays with spring-loaded terminals on auxiliary current side for direct mounting¹⁾²⁾ and stand-alone installation²⁾³⁾, CLASS 10

Features and technical specifications:

- Overload protection, phase failure protection and unbalance protection
- Internal power supply
- Auxiliary contacts 1 NO + 1 NC
- Manual and automatic RESET
- Switch position indicators
- TEST function and self-monitoring

Size contactor ⁴⁾	Rating for induction motor Rated value ⁵⁾	Current setting of the inverse-time delayed overload release	Short-circuit protection with fuse, type of coordination 2, gL/gG operational class ⁶⁾	DT	Spring-type terminals (on auxiliary current side) Order No.	Price per PU	PU (UNIT, SET, M)	PS*	PG	Weight per PU approx.	
	kW	A	A							kg	
Size S00¹⁾											
	S00	0.04 ... 0.09	0.1 ... 0.4	1	A	3RB20 16-1RD0		1	1 unit	101	0.200
		0.12 ... 0.37	0.32 ... 1.25	2	A	3RB20 16-1ND0		1	1 unit	101	0.200
		0.55 ... 1.5	1 ... 4	10	A	3RB20 16-1PD0		1	1 unit	101	0.200
		1.1 ... 5.5	3 ... 12	20	A	3RB20 16-1SD0		1	1 unit	101	0.200
3RB20 16-1RD0											
Size S0¹⁾											
	S0	0.04 ... 0.09	0.1 ... 0.4	1	A	3RB20 26-1RD0		1	1 unit	101	0.220
		0.12 ... 0.37	0.32 ... 1.25	2	A	3RB20 26-1ND0		1	1 unit	101	0.220
		0.55 ... 1.5	1 ... 4	10	A	3RB20 26-1PD0		1	1 unit	101	0.220
		1.1 ... 5.5	3 ... 12	20	A	3RB20 26-1SD0		1	1 unit	101	0.220
		3 ... 11	6 ... 25	35	A	3RB20 26-1QD0		1	1 unit	101	0.220
3RB20 26-1QD0											
Size S2¹⁾³⁾⁷⁾											
	S2	3 ... 11	6 ... 25	63	A	3RB20 36-1QD0		1	1 unit	101	0.360
					A	3RB20 36-1QX1		1	1 unit	101	0.230
		7.5 ... 22	12.5 ... 50	80	A	3RB20 36-1UD0		1	1 unit	101	0.360
					A	3RB20 36-1UX1		1	1 unit	101	0.230
3RB20 36-1UD0											
Size S3¹⁾³⁾⁷⁾											
	S3	7.5 ... 22	12.5 ... 50	160	A	3RB20 46-1UD0		1	1 unit	101	0.560
		11 ... 45	25 ... 100	315	A	3RB20 46-1ED0		1	1 unit	101	0.560
					A	3RB20 46-1EX1		1	1 unit	101	0.450
3RB20 46-1ED0											
Size S6²⁾⁷⁾											
	S6 with busbar connection	22 ... 90	50 ... 200	315	A	3RB20 56-1FF2		1	1 unit	101	1.030
	S6 with box terminals				A	3RB20 56-1FX2		1	1 unit	101	0.690
3RB20 56-1FX2											
Size S10/S12²⁾											
	S10/S12 and size 14 (3TF68/3TF69)	22 ... 110	55 ... 250	400	A	3RB20 66-1GF2		1	1 unit	101	1.820
		90 ... 450	160 ... 630	800	A	3RB20 66-1MF2		1	1 unit	101	1.820
3RB20 66-1MF2											

1) The relays with an Order No. ending with "0" are designed for direct mounting. With the matching terminal brackets (see "Accessories", page 5/60) the sizes S00 and S0 can also be installed as stand-alone units.

2) The relays with an Order No. ending with "2" are designed for direct mounting and stand-alone installation. For 3TF68/3TF69 contactors, direct mounting is not possible.

3) The relays with an Order No. ending with "1" are designed for stand-alone installation.

4) Observe maximum rated operational current of the devices.

5) Guide value for 4-pole standard motors at 50 Hz 400 V AC. The actual starting and rated data of the motor to be protected must be considered when selecting the units.

6) Maximum protection by fuse for overload relay, type of coordination 2. For fuse values in conjunction with contactors see Technical Information LV 1 T "Technical specifications" -> "Short-circuit protection with fuses for motor feeders".

7) The relays with an Order No. with "X" in penultimate position are equipped with a straight-through transformer.

Overload Relays







3RB2 Solid-State Overload Relays

3RB20, 3RB21 for standard applications

3RB20 solid-state overload relays with screw terminals on auxiliary current side for direct mounting¹⁾²⁾ and stand-alone installation²⁾³⁾, CLASS 20

Features and technical specifications:

- Overload protection, phase failure protection and unbalance protection
- Internal power supply
- Auxiliary contacts 1 NO + 1 NC
- Manual and automatic RESET
- Switch position indicators
- TEST function and self-monitoring

Size contactor ⁴⁾	Rating for induction motor Rated value ⁵⁾	Current setting of the inverse-time delayed overload release	Short-circuit protection with fuse, type of coordination 2, gL/gG operational class ⁶⁾	DT	Screw terminals (on auxiliary current side)		PU (UNIT, SET, M)	PS*	PG	Weight per PU approx.	
					Order No.	Price per PU					
	kW	A	A							kg	
Size S00¹⁾											
 3RB20 16-2RB0	S00	0.04 ... 0.09	0.1 ... 0.4	1	▶	3RB20 16-2RB0		1	1 unit	101	0.200
		0.12 ... 0.37	0.32 ... 1.25	2	▶	3RB20 16-2NB0		1	1 unit	101	0.200
		0.55 ... 1.5	1 ... 4	10	▶	3RB20 16-2PB0		1	1 unit	101	0.200
		1.1 ... 5.5	3 ... 12	20	▶	3RB20 16-2SB0		1	1 unit	101	0.200
Size S0¹⁾											
 3RB20 26-2QB0	S0	0.04 ... 0.09	0.1 ... 0.4	1	▶	3RB20 26-2RB0		1	1 unit	101	0.220
		0.12 ... 0.37	0.32 ... 1.25	2	▶	3RB20 26-2NB0		1	1 unit	101	0.220
		0.55 ... 1.5	1 ... 4	10	▶	3RB20 26-2PB0		1	1 unit	101	0.220
		1.1 ... 5.5	3 ... 12	20	▶	3RB20 26-2SB0		1	1 unit	101	0.220
		3 ... 11	6 ... 25	35	▶	3RB20 26-2QB0		1	1 unit	101	0.220
Size S2¹⁾³⁾⁷⁾											
 3RB20 36-2UB0	S2	3 ... 11	6 ... 25	63	▶	3RB20 36-2QB0		1	1 unit	101	0.360
					▶	3RB20 36-2QW1		1	1 unit	101	0.230
		7.5 ... 22	12.5 ... 50	80	▶	3RB20 36-2UB0		1	1 unit	101	0.360
					▶	3RB20 36-2UW1		1	1 unit	101	0.230
Size S3¹⁾³⁾⁷⁾											
 3RB20 46-2EB0	S3	7.5 ... 22	12.5 ... 50	160	▶	3RB20 46-2UB0		1	1 unit	101	0.560
					▶	3RB20 46-2EB0		1	1 unit	101	0.560
		11 ... 45	25 ... 100	315	▶	3RB20 46-2EW1		1	1 unit	101	0.450
Size S6²⁾⁷⁾											
 3RB20 56-2FW2	S6 with busbar connection	22 ... 90	50 ... 200	315	▶	3RB20 56-2FC2		1	1 unit	101	1.030
	S6 with box terminals				▶	3RB20 56-2FW2		1	1 unit	101	0.690
Size S10/S12²⁾											
 3RB20 66-2MC2	S10/S12 and size 14 (3TF68/3TF69)	22 ... 110	55 ... 250	400	▶	3RB20 66-2GC2		1	1 unit	101	1.820
		90 ... 450	160 ... 630	800	▶	3RB20 66-2MC2		1	1 unit	101	1.820

1) The relays with an Order No. ending with "0" are designed for direct mounting. With the matching terminal brackets (see "Accessories", page 5/60) the sizes S00 and S0 can also be installed as stand-alone units.

2) The relays with an Order No. ending with "2" are designed for direct mounting and stand-alone installation. For 3TF68/3TF69 contactors, direct mounting is not possible.

3) The relays with an Order No. ending with "1" are designed for stand-alone installation.

4) Observe maximum rated operational current of the devices.

5) Guide value for 4-pole standard motors at 50 Hz 400 V AC. The actual starting and rated data of the motor to be protected must be considered when selecting the units.

6) Maximum protection by fuse for overload relay, type of coordination 2. For fuse values in conjunction with contactors see Technical Information LV 1 T "Technical specifications" -> "Short-circuit protection with fuses for motor feeders".

7) The relays with an Order No. with "W" in penultimate position are equipped with a straight-through transformer.

Overload Relays







3RB2 Solid-State Overload Relays

3RB20, 3RB21 for standard applications

3RB20 solid-state overload relays with spring-loaded terminals on auxiliary current side for direct mounting¹⁾²⁾ and stand-alone installation²⁾³⁾, CLASS 20

Features and technical specifications:

- Overload protection, phase failure protection and unbalance protection
- Internal power supply
- Auxiliary contacts 1 NO + 1 NC
- Manual and automatic RESET
- Switch position indicators
- TEST function and self-monitoring

Size contactor ⁴⁾	Rating for induction motor Rated value ⁵⁾	Current setting of the inverse-time delayed overload release	Short-circuit protection with fuse, type of coordination 2, gL/gG operational class ⁶⁾	DT	Spring-type terminals (on auxiliary current side)	PU (UNIT, SET, M)	PS*	PG	Weight per PU approx.	
	kW	A	A		Order No.	Price per PU			kg	
Size S00¹⁾										
	S00	0.04 ... 0.09	0.1 ... 0.4	1	A	3RB20 16-2RD0	1	1 unit	101	0.200
		0.12 ... 0.37	0.32 ... 1.25	2	A	3RB20 16-2ND0	1	1 unit	101	0.200
		0.55 ... 1.5	1 ... 4	10	A	3RB20 16-2PD0	1	1 unit	101	0.200
		1.1 ... 5.5	3 ... 12	20	A	3RB20 16-2SD0	1	1 unit	101	0.200
3RB20 16-2RD0										
Size S0¹⁾										
	S0	0.04 ... 0.09	0.1 ... 0.4	1	A	3RB20 26-2RD0	1	1 unit	101	0.220
		0.12 ... 0.37	0.32 ... 1.25	2	A	3RB20 26-2ND0	1	1 unit	101	0.220
		0.55 ... 1.5	1 ... 4	10	A	3RB20 26-2PD0	1	1 unit	101	0.220
		1.1 ... 5.5	3 ... 12	20	A	3RB20 26-2SD0	1	1 unit	101	0.220
		3 ... 11	6 ... 25	35	A	3RB20 26-2QD0	1	1 unit	101	0.220
3RB20 26-2QD0										
Size S2¹⁾³⁾⁷⁾										
	S2	3 ... 11	6 ... 25	63	A	3RB20 36-2QD0	1	1 unit	101	0.360
					A	3RB20 36-2QX1	1	1 unit	101	0.230
		7.5 ... 22	12.5 ... 50	80	A	3RB20 36-2UD0	1	1 unit	101	0.360
					A	3RB20 36-2UX1	1	1 unit	101	0.230
3RB20 36-2UD0										
Size S3¹⁾³⁾⁷⁾										
	S3	7.5 ... 22	12.5 ... 50	160	A	3RB20 46-2UD0	1	1 unit	101	0.560
		11 ... 45	25 ... 100	315	A	3RB20 46-2ED0	1	1 unit	101	0.560
					A	3RB20 46-2EX1	1	1 unit	101	0.450
3RB20 46-2ED0										
Size S6²⁾⁷⁾										
	S6 with busbar connection	22 ... 90	50 ... 200	315	A	3RB20 56-2FF2	1	1 unit	101	1.030
	S6 with box terminals				A	3RB20 56-2FX2	1	1 unit	101	0.690
3RB20 56-2FX2										
Size S10/S12²⁾										
	S10/S12 and size 14 (3TF68/3TF69)	22 ... 110	55 ... 250	400	A	3RB20 66-2GF2	1	1 unit	101	1.820
		90 ... 450	160 ... 630	800	A	3RB20 66-2MF2	1	1 unit	101	1.820
3RB20 66-2MF2										

1) The relays with an Order No. ending with "0" are designed for direct mounting. With the matching terminal brackets (see "Accessories", page 5/60) the sizes S00 and S0 can also be installed as stand-alone units.

2) The relays with an Order No. ending with "2" are designed for direct mounting and stand-alone installation. For 3TF68/3TF69 contactors, direct mounting is not possible.

3) The relays with an Order No. ending with "1" are designed for stand-alone installation.

4) Observe maximum rated operational current of the devices.

5) Guide value for 4-pole standard motors at 50 Hz 400 V AC. The actual starting and rated data of the motor to be protected must be considered when selecting the units.

6) Maximum protection by fuse for overload relay, type of coordination 2. For fuse values in conjunction with contactors, see Technical Information LV 1 T "Technical specifications" -> "Short-circuit protection with fuses for motor feeders".

7) The relays with an Order No. with "X" in penultimate position are equipped with a straight-through transformer.

Overload Relays







3RB2 Solid-State Overload Relays

3RB20, 3RB21 for standard applications

3RB21 solid-state overload relays with screw terminals on auxiliary current side for direct mounting¹⁾²⁾ and stand-alone installation²⁾³⁾, CLASS 5, 10, 20 and 30 adjustable

Features and technical specifications:

- Overload protection, phase failure protection and unbalance protection
- Internal ground-fault detection (activatable)
- Internal power supply
- Auxiliary contacts 1 NO + 1 NC
- Manual and automatic RESET
- Electrical remote RESET integrated
- Switch position indicators
- TEST function and self-monitoring

Size contactor ⁴⁾	Rating for induction motor Rated value ⁵⁾	Current setting of the inverse-time delayed overload release	Short-circuit protection with fuse, type of coordination 2, gL/gG operational class ⁶⁾	DT	Screw terminals (on auxiliary current side)		PU (UNIT, SET, M)	PS*	PG	Weight per PU approx.		
					Order No.	Price per PU						
	kW	A	A							kg		
Size S00¹⁾												
	S00	0.04 ... 0.09	0.1 ... 0.4	1	▶	3RB21 13-4RB0		1	1 unit	101	0.200	
		0.12 ... 0.37	0.32 ... 1.25	2	▶	3RB21 13-4NB0		1	1 unit	101	0.200	
		0.55 ... 1.5	1 ... 4	10	▶	3RB21 13-4PB0		1	1 unit	101	0.200	
		1.1 ... 5.5	3 ... 12	20	▶	3RB21 13-4SB0		1	1 unit	101	0.200	
Size S0¹⁾												
	S0	0.04 ... 0.09	0.1 ... 0.4	1	▶	3RB21 23-4RB0		1	1 unit	101	0.220	
		0.12 ... 0.37	0.32 ... 1.25	2	▶	3RB21 23-4NB0		1	1 unit	101	0.220	
		0.55 ... 1.5	1 ... 4	10	▶	3RB21 23-4PB0		1	1 unit	101	0.220	
		1.1 ... 5.5	3 ... 12	20	▶	3RB21 23-4SB0		1	1 unit	101	0.220	
		3 ... 11	6 ... 25	35	▶	3RB21 23-4QB0		1	1 unit	101	0.220	
Size S2¹⁾³⁾⁷⁾												
	S2	3 ... 11	6 ... 25	63	▶	3RB21 33-4QB0		1	1 unit	101	0.360	
						▶	3RB21 33-4QW1		1	1 unit	101	0.230
		7.5 ... 22	12.5 ... 50	80	▶	3RB21 33-4UB0		1	1 unit	101	0.360	
					▶	3RB21 33-4UW1		1	1 unit	101	0.230	
Size S3¹⁾³⁾⁷⁾												
	S3	7.5 ... 22	12.5 ... 50	160	▶	3RB21 43-4UB0		1	1 unit	101	0.560	
						▶	3RB21 43-4EB0		1	1 unit	101	0.560
		11 ... 45	25 ... 100	315	▶	3RB21 43-4EW1		1	1 unit	101	0.450	
Size S6²⁾⁷⁾												
	S6 with busbar connection	22 ... 90	50 ... 200	315	▶	3RB21 53-4FC2		1	1 unit	101	1.030	
	S6 with box terminals				▶	3RB21 53-4FW2		1	1 unit	101	0.690	
Size S10/S12²⁾												
	S10/S12 and size 14	22 ... 110	55 ... 250	400	▶	3RB21 63-4GC2		1	1 unit	101	1.820	
	(3TF68/3TF69)	90 ... 450	160 ... 630	800	▶	3RB21 63-4MC2		1	1 unit	101	1.820	

1) The relays with an Order No. ending with "0" are designed for direct mounting. With the matching terminal brackets (see "Accessories", page 5/60) the sizes S00 and S0 can also be installed as stand-alone units.

2) The relays with an Order No. ending with "2" are designed for direct mounting and stand-alone installation. For 3TF68/3TF69 contactors, direct mounting is not possible.

3) The relays with an Order No. ending with "1" are designed for stand-alone installation.

4) Observe maximum rated operational current of the devices.

5) Guide value for 4-pole standard motors at 50 Hz 400 V AC. The actual starting and rated data of the motor to be protected must be considered when selecting the units.

6) Maximum protection by fuse for overload relay, type of coordination 2. For fuse values in conjunction with contactors, see Technical Information LV 1 T "Technical specifications" -> "Short-circuit protection with fuses for motor feeders".

7) The relays with an Order No. with "W" in penultimate position are equipped with a straight-through transformer.

Overload Relays







3RB2 Solid-State Overload Relays

3RB20, 3RB21 for standard applications

3RB21 solid-state overload relays with spring-loaded terminals on auxiliary current side for direct mounting¹⁾²⁾ and stand-alone installation¹⁾³⁾, CLASS 5, 10, 20 and 30 adjustable

Features and technical specifications:

- Overload protection, phase failure protection and unbalance protection
- Internal ground-fault detection (activatable)
- Internal power supply
- Auxiliary contacts 1 NO + 1 NC
- Manual and automatic RESET
- Electrical remote RESET integrated
- Switch position indicators
- TEST function and self-monitoring

Size contactor ⁴⁾	Rating for induction motor Rated value ⁵⁾	Current setting of the inverse-time delayed overload release	Short-circuit protection with fuse, type of coordination 2, gL/gG operational class ⁶⁾	DT	Spring-type terminals (on auxiliary current side)	PU (UNIT, SET, M)	PS*	PG	Weight per PU approx.	
					Order No.					Price per PU
	kW	A	A						kg	
Size S00¹⁾										
	S00	0.04 ... 0.09	0.1 ... 0.4	1	A	3RB21 13-4RD0	1	1 unit	101	0.200
		0.12 ... 0.37	0.32 ... 1.25	2	A	3RB21 13-4ND0	1	1 unit	101	0.200
		0.55 ... 1.5	1 ... 4	10	A	3RB21 13-4PD0	1	1 unit	101	0.200
		1.1 ... 5.5	3 ... 12	20	A	3RB21 13-4SD0	1	1 unit	101	0.200
Size S0¹⁾										
	S0	0.04 ... 0.09	0.1 ... 0.4	1	▶	3RB21 23-4RD0	1	1 unit	101	0.220
		0.12 ... 0.37	0.32 ... 1.25	2	▶	3RB21 23-4ND0	1	1 unit	101	0.220
		0.55 ... 1.5	1 ... 4	10	▶	3RB21 23-4PD0	1	1 unit	101	0.220
		1.1 ... 5.5	3 ... 12	20	A	3RB21 23-4SD0	1	1 unit	101	0.220
		3 ... 11	6 ... 25	35	A	3RB21 23-4QD0	1	1 unit	101	0.220
Size S2¹⁾³⁾⁷⁾										
	S2	3 ... 11	6 ... 25	63	A	3RB21 33-4QD0	1	1 unit	101	0.360
		7.5 ... 22	12.5 ... 50	80	A	3RB21 33-4QX1	1	1 unit	101	0.230
					A	3RB21 33-4UD0	1	1 unit	101	0.360
					A	3RB21 33-4UX1	1	1 unit	101	0.230
Size S3¹⁾³⁾⁷⁾										
	S3	7.5 ... 22	12.5 ... 50	160	A	3RB21 43-4UD0	1	1 unit	101	0.560
		11 ... 45	25 ... 100	315	A	3RB21 43-4ED0	1	1 unit	101	0.560
					A	3RB21 43-4EX1	1	1 unit	101	0.450
Size S6²⁾⁷⁾										
	S6 with busbar connection	22 ... 90	50 ... 200	315	A	3RB21 53-4FF2	1	1 unit	101	1.030
					A	3RB21 53-4FX2	1	1 unit	101	0.690
Size S10/S12²⁾										
	S10/S12 and size 14 (3TF68/3TF69)	22 ... 110	55 ... 250	400	A	3RB21 63-4GF2	1	1 unit	101	1.820
		90 ... 450	160 ... 630	800	A	3RB21 63-4MF2	1	1 unit	101	1.820

¹⁾ The relays with an Order No. ending with "0" are designed for direct mounting. With the matching terminal brackets (see "Accessories", page 5/60) the sizes S00 and S0 can also be installed as stand-alone units.

²⁾ The relays with an Order No. ending with "2" are designed for direct mounting and stand-alone installation. For 3TF68/3TF69 contactors, direct mounting is not possible.

³⁾ The relays with an Order No. ending with "1" are designed for stand-alone installation.

⁴⁾ Observe maximum rated operational current of the devices.

⁵⁾ Guide value for 4-pole standard motors at 50 Hz 400 V AC. The actual starting and rated data of the motor to be protected must be considered when selecting the units.

⁶⁾ Maximum protection by fuse for overload relay, type of coordination 2. For fuse values in conjunction with contactors, see Technical Information LV 1 T "Technical specifications" -> "Short-circuit protection with fuses for motor feeders".

⁷⁾ The relays with an Order No. with "X" in penultimate position are equipped with a straight-through transformer.

Overload Relays

3RB2 Solid-State Overload Relays

3RB22, 3RB23 for high-feature applications

Overview

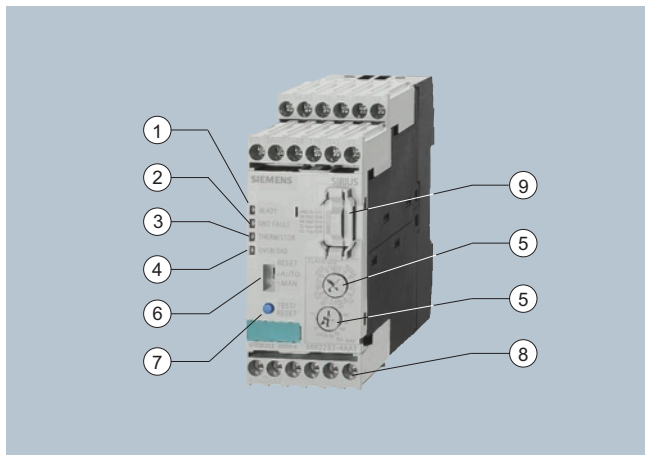

3RB22/3RB23 evaluation module

- (1) Green "READY" LED:
A continuous green light signals that the device is working correctly.
- (2) Red "GND FAULT" LED
A continuous red light signals a ground-fault tripping.
- (3) Red "THERMISTOR" LED:
A continuous red light signals an active thermistor trip.
- (4) Red "OVERLOAD" LED:
A continuous red light signals an active overload trip; a flickering red light signals an imminent trip (overload warning).
- (5) Motor current and trip class adjustment:
Setting the device to the motor current and to the required trip class dependent on the start-up conditions is easy with the two rotary switches.
- (6) Selector switch for manual/automatic RESET:
With this switch you can choose between manual and automatic RESET.
- (7) Test/RESET button:
Enables testing of all important device components and functions, plus resetting of the device after a trip when manual RESET is selected.
- (8) Connecting terminals (removable joint block):
The generously sized terminals permit connection of two conductors with different cross-sections for the auxiliary, control and sensor circuits. Connection is possible with screw connection and alternatively with spring-type connection.
- (9) 3RB29 85 function expansion module:
Enables more functions to be added, e. g. internal ground-fault detection and/or an analog output with corresponding signals.

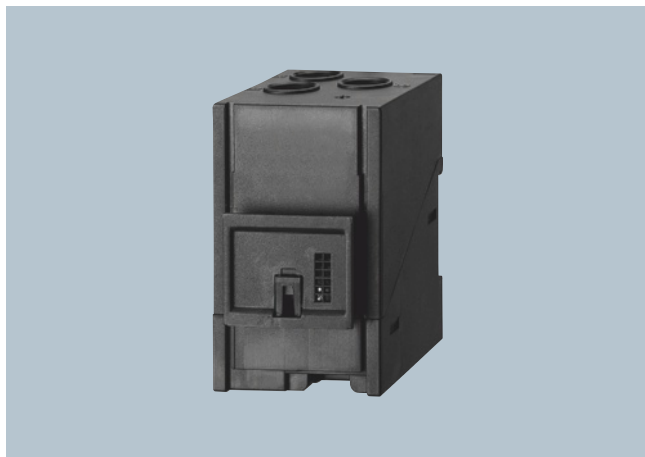

3RB29 06 current measuring module

The modular, solid-state overload relays with external power supply type 3RB22 (with monostable auxiliary contacts) and type 3RB23 (with bistable auxiliary contacts) up to 630 A (up to 820 A possible with a series transformer) have been designed for inverse-time delayed protection of loads with normal and heavy starting (see [Technical Information LV 1 T, "Function"](#)) against excessive temperature rises due to overload, phase unbalance or phase failure. An overload, phase unbalance or phase failure result in an increase of the motor current beyond the set rated motor current. This current rise is detected by means of a current measuring module and electronically evaluated by a special evaluation module which is connected to it. The evaluation electronics sends a signal to the auxiliary contacts. The auxiliary contacts then switch off the load by means of a contactor. The break time depends on the ratio between the tripping current and current setting I_e and is stored in the form of a long-term stable tripping characteristic (see [Technical Information LV 1 T, "Characteristic Curves"](#)). The "tripped" status is signaled by means of a continuous red "OVERLOAD" LED.

The LED indicates imminent tripping of the relay due to overload, phase unbalance or phase failure by flickering when the limit current has been violated. This warning can also be issued as a signal through auxiliary contacts.

In addition to the described inverse-time delayed protection of loads against excessive temperature rises, the 3RB22/3RB23 solid-state overload relays also allow direct temperature monitoring of the motor windings (full motor protection) by connection with broken-wire interlock of a PTC sensor circuit. With this temperature-dependent protection, the loads can be protected against overheating caused indirectly by reduced coolant flow, for example, which cannot be detected by means of the current alone. In the event of overheating, the devices switch off the contactor, and thus the load, by means of the auxiliary contacts. The "tripped" status is signaled by means of a continuously illuminated "THERMISTOR" LED.

To also protect the loads against high-resistance short-circuits due to damage to the insulation, humidity, condensed water, etc., the 3RB22/3RB23 solid-state overload relays offer the possibility of internal ground-fault detection in conjunction with a function expansion module (for details see ["Selection and ordering data"](#), not possible in conjunction with contactor assembly for Wye-Delta starting). In the event of a ground fault the 3RB22/3RB23 relays trip instantaneously. The "tripped" status is signaled by means of a continuous red "Ground Fault" LED. Signaling through auxiliary contacts is also possible.

After tripping due to overload, phase unbalance, phase failure, thermistor or ground-fault tripping, the relay is reset manually or automatically after the recovery time has elapsed (see [Technical Information LV 1 T, "Function"](#)).

In conjunction with a function expansion module the motor current measured by the microprocessor can be output in the form of an analog signal 4 ... 20 mA DC for operating rotary coil instruments or for feeding into analog inputs of programmable logic controllers. With an additional AS-Interface analog module the current values can also be transferred over the AS-i bus system.

The devices are manufactured in accordance with environmental guidelines and contain environmentally friendly and reusable materials.

They comply with all important worldwide standards and approvals.

Overload Relays

3RB2 Solid-State Overload Relays

3RB22, 3RB23 for high-feature applications

"Increased safety" type of protection EEx e according to ATEX directive 94/9/EC

The 3RB22 (monostable) solid-state overload relays are suitable for the overload protection of explosion-proof motors with "increased safety" type of protection EEx e. The relays meet the requirements of EN 60079-7 (Electrical apparatus for areas subject to explosion hazards – Increased safety "e"); see Chapter 20 "Appendix" --> "Standards and approvals" --> "Type overview of approved devices for potentially explosive areas (ATEX explosion protection)".

EC type test certificate for Group II, Category (2) G/D exists. It has the number PTB 05 ATEX 3022.

Benefits

The most important features and benefits of the 3RB22/3RB23 solid-state overload relays are listed in the overview table (see "Overload Relays" --> "General data").

Application

Industries

The 3RB22/3RB23 solid-state overload relays are suitable for customers from all industries who want to guarantee optimum inverse-time delayed and temperature-dependent protection of their electrical loads (e. g. motors) under normal and heavy starting conditions (CLASS 5 to CLASS 30), minimize project completion times, inventories and power consumption, and optimize plant availability and maintenance management.

Application

The 3RB22/3RB23 solid-state overload relays have been designed for the protection of three-phase asynchronous and single-phase AC motors.

If single-phase AC motors are to be protected by the 3RB22/3RB23 solid-state overload relays, the main current paths of the current measuring modules must be series-connected (see Technical Information LV 1 T, "Schematics").

Ambient conditions

The devices are insensitive to external influences such as shocks, corrosive environments, ageing and temperature fluctuation.

For the temperature range from -25 °C to $+60\text{ °C}$, the 3RB22/3RB23 solid-state overload relays compensate the temperature according to IEC 60947-4-1.

Configuration notes for use of the devices below -25 °C or above $+60\text{ °C}$ on request.

Accessories

The following accessories are available for the 3RB22/3RB23 solid-state overload relays:

- A sealable cover for the evaluation module
- Box terminal blocks for the current measuring modules size S6 and S10/S12
- Terminal covers for the current measuring modules size S6 and S10/S12
- Push-in lugs for screw fixing the sizes S00 to S3 current measuring modules

Overload Relays

3RB2 Solid-State Overload Relays

3RB22, 3RB23 for high-feature applications

Selection and ordering data

3RB22/3RB23 solid-state overload relays for full motor protection with screw terminals or spring-loaded terminals for stand-alone installation, CLASS 5, 10, 20 and 30 adjustable

Features and technical specifications:

- Overload protection, phase failure protection and unbalance protection
- External power supply 24 ... 240 V AC/DC
- Auxiliary contacts 2 NO + 2 NC
- Manual and automatic RESET
- Electrical remote RESET integrated
- 4 LEDs for operating and status displays
- TEST function and self-monitoring
- Internal ground-fault detection with function expansion module
- Screw terminals or spring-loaded terminals for auxiliary, control and sensor circuits
- Input for PTC sensor circuit
- Analog output with function expansion module

Size of contactor	Version	DT	Screw terminals 	PU (UNIT, SET, M)	PS*	PG	Weight per PU approx. kg
			Order No.	Price per PU			

Evaluation modules



3RB2. 83-4AA1

S00 ... S12	Monostable	▶	3RB22 83-4AA1		1	1 unit	101	0.300
	Bistable	▶	3RB23 83-4AA1		1	1 unit	101	0.300

Size of contactor	Version	DT	Spring-type terminals 	PU (UNIT, SET, M)	PS*	PG	Weight per PU approx. kg
			Order No.	Price per PU			

Evaluation modules



3RB2. 83-4AC1

S00 ... S12	Monostable	A	3RB22 83-4AC1		1	1 unit	101	0.300
	Bistable	A	3RB23 83-4AC1		1	1 unit	101	0.300

Size of contactor	Version	DT	Order No.	Price per PU	PU (UNIT, SET, M)	PS*	PG	Weight per PU approx. kg
-------------------	---------	----	-----------	--------------	-------------------	-----	----	--------------------------

Function expansion modules



S00 ... S12	For plugging into evaluation module (1 unit)							
	Analog Basic 1 modules¹⁾ Analog output 4 ... 20 mA DC, with overload warning	▶	3RB29 85-2AA0		1	1 unit	101	0.030
	Analog Basic 1 GF modules¹⁾²⁾ Analog output 4 ... 20 mA DC, with internal ground-fault detection and overload warning	▶	3RB29 85-2AA1		1	1 unit	101	0.030
	Analog Basic 2 GF modules¹⁾²⁾ Analog output 4 ... 20 mA DC, with internal ground-fault detection and ground-fault signaling	▶	3RB29 85-2AB1		1	1 unit	101	0.030
	Basic 1 GF modules²⁾ with internal ground-fault detection and overload warning	▶	3RB29 85-2CA1		1	1 unit	101	0.030
	Basic 2 GF modules²⁾ with internal ground-fault detection and ground-fault signaling	▶	3RB29 85-2CB1		1	1 unit	101	0.030

Note: Analog input modules, e. g. SM 331, must be configured for 4-wire measuring transducers. In this case the analog input module must not supply current to the analog output of the 3RB22/ 3RB23 relay.

¹⁾ The analog signal 4 ... 20 mA DC can be used for operating rotary coil instruments or for feeding into analog inputs of programmable logic controllers.

²⁾ The following information on ground-fault protection refers to sinusoidal residual currents at 50/60 Hz:

- With a motor current of between 0.3 and 2 times the current setting I_{ϕ} the unit will trip at a ground-fault current equal to 30 % of the set current.
- With a motor current of between 2 and 8 times the current setting I_{ϕ} the unit will trip at a ground-fault current equal to 15 % of the set current.
- The response delay amounts to between 0.5 and 1 second.





* You can order this quantity or a multiple thereof.

Overload Relays

3RB2 Solid-State Overload Relays

3RB22, 3RB23 for high-feature applications

Current measuring modules for direct mounting¹⁾ and stand-alone installation¹⁾²⁾

Size of contactor ³⁾	Rating for induction motor rated value ⁴⁾	Current setting of the inverse-time delayed overload release	Short-circuit protection with fuse, type of coordination 2, gL/gG operational class ⁵⁾	DT	Order No.	Price per PU	PU (UNIT, SET, M)	PS*	PG	Weight per PU approx.
	kW	A								kg
Size S00/S0²⁾⁶⁾										
	S00/S0	0.09 ... 1.1	0.3 ... 3	20	▶ 3RB29 06-2BG1		1	1 unit	101	0.100
		1.1 ... 11	2.4 ... 25	63	▶ 3RB29 06-2DG1		1	1 unit	101	0.150
Size S2/S3²⁾⁶⁾										
	S2/S3	5.5 ... 45	10 ... 100	315	▶ 3RB29 06-2JG1		1	1 unit	101	0.350
Size S6¹⁾⁶⁾										
	S6 with busbar connection	11 ... 90	20 ... 200	315	▶ 3RB29 56-2TH2		1	1 unit	101	1.000
	S6 with box terminals				▶ 3RB29 56-2TG2		1	1 unit	101	0.600
Size S10/S12¹⁾										
	S10/S12 and size 14 (3TF68/3TF69)	37 ... 450	63 ... 630	800	▶ 3RB29 66-2WH2		1	1 unit	101	1.750

Note:

The connecting cable between the current measuring module and the evaluation module is not included in the scope of supply; please order separately.

1) The current measuring modules with an Order No. ending with "2" are designed for direct mounting and stand-alone installation. For 3TF68/3TF69 contactors, direct mounting is not possible.

2) The current measuring modules with an Order No. ending with "1" are designed for stand-alone installation.

3) Observe maximum rated operational current of the devices.

4) Guide value for 4-pole standard motors at 50 Hz 400 V AC. The actual starting and rated data of the motor to be protected must be considered when selecting the units.

5) Maximum protection by fuse for overload relay, type of coordination 2. For fuse values in conjunction with contactors, see Technical Information LV 1 T "Technical specifications" -> "Short-circuit protection with fuses for motor feeders".

6) The modules with an Order No. with "G" in penultimate position are

Accessories

Size of contactor	Version	DT	Order No.	Price per PU	PU (UNIT, SET, M)	PS*	PG	Weight per PU approx.
								kg
Connecting cables (essential accessory)								
	S00 ... S3	For connection between evaluation module and current measuring module	▶ 3RB29 87-2B		1	1 unit	101	0.010
	S00 ... S12	• Length 0.1 m (only for mounting of the evaluation module directly onto the current measuring module)	▶ 3RB29 87-2D		1	1 unit	101	0.020

3RB29 87-2.

For more accessories, see page 5/60.

Overload Relays

3RB2 Solid-State Overload Relays

Accessories

Overview

Overload relays for standard applications

The following optional accessories are available for the 3RB20/3RB21 solid-state overload relays:



- One terminal bracket each for the overload relays size S00 and S0 (sizes S2 to S12 can be installed as stand-alone installation without a terminal bracket)
- One mechanical remote RESET module for all sizes
- One cable release for resetting devices which are difficult to access (for all sizes)
- One sealable cover for all sizes
- Box terminal blocks for sizes S6 and S10/S12
- Terminal covers for sizes S2 to S10/S12

Overload relays for high-feature applications

The following optional accessories are available for the 3RB22/3RB23 solid-state overload relays:

- A sealable cover for the evaluation module
- Box terminal blocks for the current measuring modules size S6 and S10/S12
- Terminal covers for the current measuring modules size S6 and S10/S12
- Push-in lugs for screw fixing the sizes S00 to S3 current measuring modules

Selection and ordering data

Version	Size	DT	Order No.	Price	PU (UNIT, SET, M)	PS*	PG	Weight per PU approx. kg
Terminal brackets for stand-alone installation¹⁾								
	For separate mounting of the overload relays; screw and snap-on mounting onto TH 35 standard mounting rail	S00	▶ 3RB29 13-0AA1		1	1 unit	101	0.060
		S0	▶ 3RB29 23-0AA1		1	1 unit	101	0.080
Mechanical RESET²⁾								
	Resetting plungers, holders and formers	S00 ... S10/S12	▶ 3RU19 00-1A		1	1 unit	101	0.038
	Pushbuttons with extended stroke (12 mm), IP65, Ø 22 mm		B 3SB30 00-0EA11		1	1 unit	102	0.020
	Extension plungers For compensation of the distance between a pushbutton and the unlatching button of the relay		A 3SX1 335		1	1 unit	102	0.004
Cable releases with holder for RESET²⁾								
	For Ø 6.5 mm holes in the control panel; max. control panel thickness 8 mm	S00 ... S10/S12						
	<ul style="list-style-type: none"> • Length 400 mm • Length 600 mm 		▶ 3RU19 00-1B		1	1 unit	101	0.063
			▶ 3RU19 00-1C		1	1 unit	101	0.073

3RB29 .3-0AA1

3RU19 00-1A with pushbutton and extension plunger

3RU19 00-1.









¹⁾ Only for 3RB20/3RB21.

²⁾ Only for 3RB20/3RB21. The accessories are identical to those of the 3RU11 thermal overload relays.

Overload Relays

3RB2 Solid-State Overload Relays

Accessories

Version	Size	DT	Order No.	Price	PU (UNIT, SET, M)	PS*	PG	Weight per PU approx. kg
Sealable covers								
	For covering the setting knobs • For 3RB20/3RB21	S00 ... S10/S12	▶ 3RB29 84-0		1	10 units	101	0.020
	• For 3RB22/3RB23	--	▶ 3RB29 84-2		1	10 units	101	0.050
Terminal covers								
	Covers for cable lugs and busbar connections • Length 55 mm ¹⁾ • Length 100 mm • Length 120 mm	S3 S6 S10/S12	▶ 3RT19 46-4EA1 ▶ 3RT19 56-4EA1 ▶ 3RT19 66-4EA1		1 1 1	1 unit 1 unit 1 unit	101 101 101	0.040 0.070 0.130
3RT19 46-4EA1								
	Covers for box terminals • Length 20.6 mm ¹⁾ • Length 20.8 mm ¹⁾ • Length 25 mm • Length 30 mm	S2 S3 S6 S10/S12	▶ 3RT19 36-4EA2 ▶ 3RT19 46-4EA2 ▶ 3RT19 56-4EA2 ▶ 3RT19 66-4EA2		1 1 1 1	1 unit 1 unit 1 unit 1 unit	101 101 101 101	0.020 0.025 0.030 0.040
3RT19 36-4EA2								
The figures show mounting on the contactor	Covers for screw terminals Between contactor and overload relay, without box terminals (1 unit required per combination)	S6 S10/S12	▶ 3RT19 56-4EA3 ▶ 3RT19 66-4EA3		1 1	1 unit 1 unit	101 101	0.020 0.060
Box terminal blocks								
	For round and ribbon cables • Up to 70 mm ² • Up to 120 mm ² • Up to 240 mm ² For conductor cross-sections see Technical Information LV 1 T, "Technical specifications".	S6 ²⁾ S6 S10/S12	▶ 3RT19 55-4G ▶ 3RT19 56-4G ▶ 3RT19 66-4G		1 1 1	1 unit 1 unit 1 unit	101 101 101	0.230 0.260 0.676
3RT19 5.-4G								
Push-in lugs								
	For screw fixing of 3RB22/3RB23 overload relays	--	▶ 3RP19 03		1	10 units	101	0.002
3RP19 03								
	For screw fixing of 3RB29 06 current measuring modules (2 units are required per module)	S00 ...S3	A 3RB19 00-0B		100	10 units	101	0.100
3RB19 00-0B								
Tools for opening spring-loaded terminals by hand								
	Screwdrivers, 2.5 mm x 0.4 mm, length approx. 160 mm; green, suitable for a max. conductor cross-section of 1.5 mm ²	Can be used for auxiliary circuit connections	C 8WH9 200-0AA00		1	10 units	044	0.032

¹⁾ Only for 3RB20/3RB21. The accessories are identical to those of the 3RU11 thermal overload relays.

²⁾ In the scope of supply for 3RT10 54-1 contactors (55 kW).

Overload Relays

3RB2 Solid-State Overload Relays

Accessories

Version	Size/ Color	Use	DT	Order No.	Price per PU	PU (UNIT, SET, M)	PS*	PG	Weight per PU approx. kg	
Tools for opening Cage Clamp terminals										
 8WA2 803	Screwdrivers									
	3.5 mm x 0.5 mm, suitable for a max. conductor cross-section of 2.5 mm ²	Length approx. 175 mm; green, partially insulated	Main and auxiliary circuit connections	C	8WA2 880		1	1 unit	041	0.034
		Length approx. 175 mm; green		C	8WA2 803		1	1 unit	041	0.024
Blank labels										
3RT19 00-1SB10	Unit labeling plates For SIRIUS devices		10 mm x 7 mm, pastel turquoise	3RB2, 3RU11	D	3RT19 00-1SB10	100	816 units	101	24.000
			20 mm x 7 mm, pastel turquoise		C	3RT19 00-1SB20	100	340 units	101	0.200
	Inscription labels for sticking For SIRIUS devices		19 mm x 6 mm, pastel turquoise	3RB2, 3RU11	D	3RT19 00-1SB60	100	3060 units	101	15.000
			19 mm x 6 mm zinc yellow		C	3RT19 00-1SD60	100	3060 units	101	12.000
Computer labeling systems										
For individual inscription of unit labeling plates										
Obtainable from:										
murrplastik Systemtechnik GmbH										
http://www.murrplastik.com										