

CINCON ELECTRONICS

LOW POWER 1-60W DC-DC CONVERTER CATALOG 2016

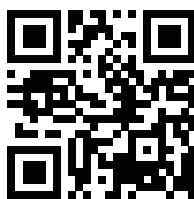
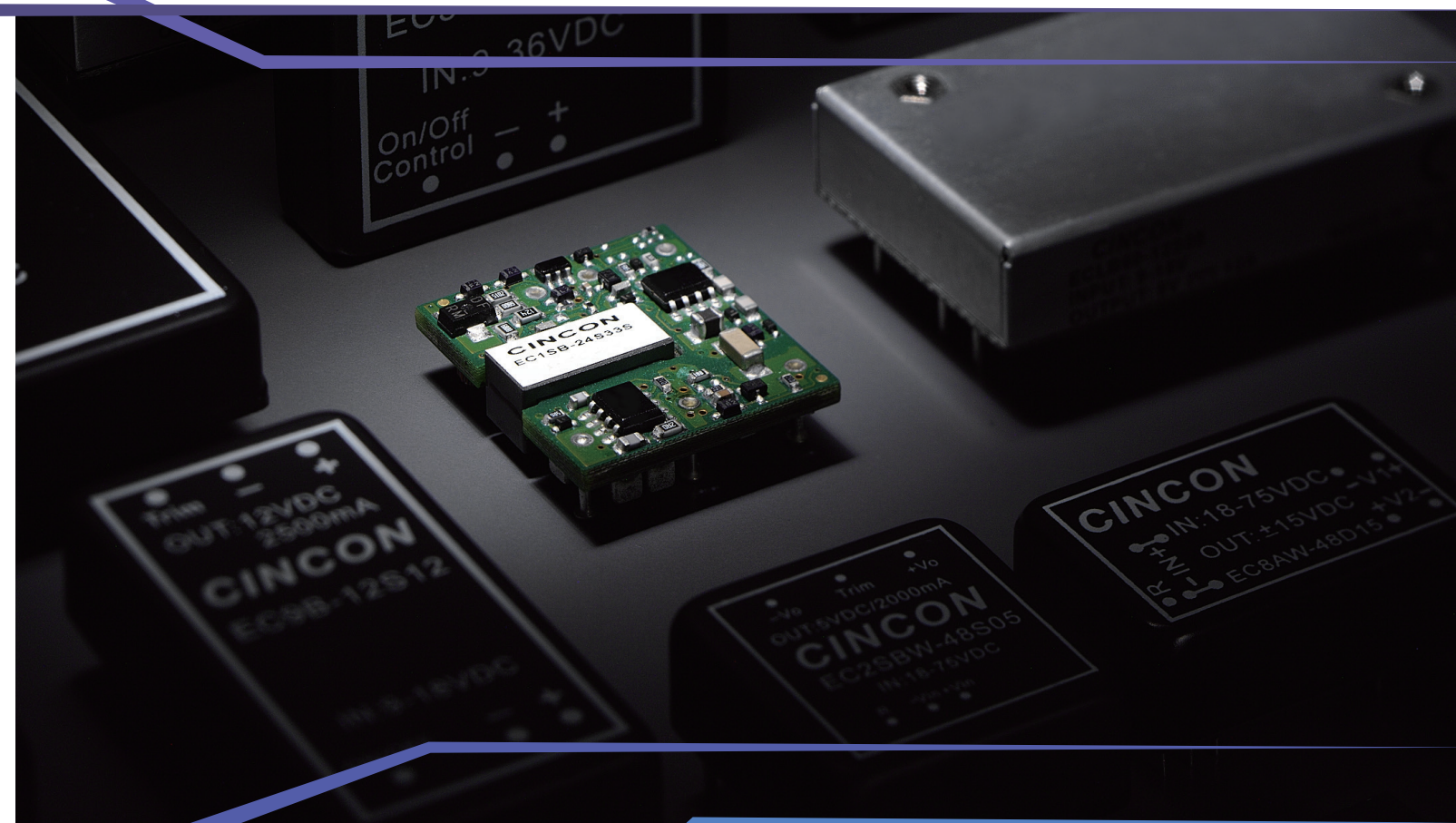

WWW.CINCON.COM

CINCON HEADQUARTERS

14F , No. 306, Section 4, Hsin Yi Road Taipei, Taiwan, R.O.C.
Tel : (886-2) 2708-6210 | Fax : (886-2) 2702-9852
E-mail : sales@cincon.com.tw

CINCON USA

1655 Mesa Verde Ave, Ste 180 Ventura , CA 93003 USA
Tel : (805) 639-3350 | Fax : (805) 639-4101
E-mail : info@cincon.com



Every day, 365 days a year Cincon makes a difference in people's lives throughout the world.

Design engineers and other power supply specifiers select our AC-DC and DC-DC convertors to power a wide range of products. Cincon power supplies are found in a myriad of applications, from medical equipment used to keep us healthy, to security systems working to keep us safe. Name an electronic device in any equipment category and it's likely you'll find a Cincon power supply inside. The communications, test instrumentation, entertainment, lighting, medical, computer, networking, industrial and transportation industries all use Cincon power supplies.

Cincon gives power supply specifiers what they need, speed and specification. Need a power supply fast? Designers can select from one of our 25,000 plus standard model numbers, many available off the shelf from distributors located around the globe. Give us a little more time and we can modify one of our standard products to your requirement. Need a full custom power supply? We do that also.

Using state of the art design tools, our power supplies are engineered with proven technology in one of our two Taiwan design laboratories. We focus heavily on reliability

in the early stages of development to ensure a robust final product. Combined with extensive verification testing at the prototype and pilot production stages, Cincon is able to offer power supplies with long operational lives.

Cincon AC-DC and DC-DC power supplies are manufactured in one of our wholly owned, ISO 9001 and ISO 14001 certified, manufacturing facilities in Taiwan and China. Products are built using the latest manufacturing and quality assurance techniques on state of the art equipment; giving our customers not only high quality but also short lead times.

As a global designer and manufacturer of AC-DC and DC-DC power supplies, our products are certified to international safety, efficiency, hazardous substance and EMI standards where required. We also have capability to design and certify to application and country specific standards.

When you require an AC-DC or DC-DC power supply, standard or custom, and have little time, look to us for a solution. Let Cincon power your idea.

CONTENTS

QUICK SELECTION		2	EC6A	7.5W	44	EC7B	20W	86
EC1TAN	1W	4	EC6AW	8W	46	EC7BW	20W	88
EC1SAN	1W	6	EC7A	10W	48	EC7BW-110	20W	90
EC2SA	2W	8	EC8AW	15W	50	EC9B	30W	92
EC2SAN	2W	10	EC1SB	15W	52	EC9BW	30W	94
EC3SA	3W	12	EC2SB	10W	54	ECLB40W	40W	96
EC3SAW	3W	14	EC2SBW	10W	56	ECLB40W-110	40W	98
EC4SAW	6W	16	EC3SB	15W	58	ECLB60	60W	100
LAN-1	2W	18	EC3SBW	15W	60	ECLB60W	60W	102
EC2A	1.5W	20	EC4SBW	20W	62	EC1SC	20W	104
EC3A	3W	22	EC5SBW	30W	64	EC2SC	25W	106
EC3AE	3W	24	EC3B	7.5W	66	EC3SCW	30W	108
EC3A-E	3W	26	EC3BB	7.5W	68	EC3C	15W	110
EC3AB	3W	28	EC4B	10W	70	EC3CB	15W	112
EC3AW	3W	30	EC4BE	10W	72	EC5C	15W	114
EC4A	6W	32	EC4BW	10W	74	EC6C	30W	116
EC4A-E	6W	34	EC4BU	10W	76	EC7C	40W	118
EC4AB	6W	36	EC5B	15W	78	EC5E	30W	120
EC4AW	6W	38	EC5BE	15W	80	EC6E	30W	122
EC4AW-H6	6W	40	EC5BW	15W	82			
EC5A	6-24W	42	EC5BU	15W	84			
						REQUEST FOR QUOTE		124

QUICK SELECTION

OUTPUT	INPUT VOLTAGE	OUTPUT VOLTAGE	PACKAGE	ISOLATION	EFF %	Series	PAGE
1W	5V, 12V, 24V	5V, 12V, 15V	SIP 4	1000VDC	82%	EC1TAN	4
	5V, 12V, 24V	5V, 12V, 15V, +/-5V, +/-12V, +/-15V	SIP 6 / SMD	1000VDC	83%	EC1SAN	6
1.5W	5V, 12V, 24V, 28V, 48V	5V, 12V, 15V, +/-12V, +/-15V	DIP 24	500, 1500, 3000VDC	50%	EC2A	20
2W	4.5-9V, 9-18V, 18-36V, 36-75V	3.3V, 5V, 12V, 15V, +/-5V, +/-12V, +/-15V	SIP 8	1500VDC	84%	EC2SA	8
	5V, 12V, 24V	5V, 12V, 15V, +/-5V, +/-12V, +/-15V	SIP 6	1000VDC	86%	EC2SAN	10
	5V, 12V	9V	DIP 24	500VDC	70%	LAN-1	18
3W	4.5-6V, 9-18V, 18-36V, 36-72V	3.3V, 5V, 12V, 15V, +/-5V, +/-12V, +/-15V	DIP 24	500, 1500, 3000VDC	87%	EC3A	22
	4.5-9V, 9-18V, 18-36V, 36-72V	3.3V, 5V, 12V, 15V, +/-5V, +/-12V, +/-15V	DIP 24	500, 1500, 3000VDC	87%	EC3A-E	26
	4.5-9V, 9-18V, 18-36V, 36-75V	3.3V, 5V, 12V, 15V, +/-5V, +/-12V, +/-15V	SIP 8	1500VDC	86%	EC3SA	12
	5V, 12V, 24V, 28V, 48V	5V, 12V, 15V, +/-12V, +/-15V	DIP 24	500VDC	61%	EC3AE	24
	9-18V, 18-36V, 36-72V	3.3V, 5V, 12V, 15V, +/-5V, +/-12V, +/-15V	DIP 24	500, 1500, 3000VDC	80%	EC3AB	28
	9-36V, 18-75V	3.3V, 5V, 12V, 15V, +/-5V, +/-12V, +/-15V	SIP 8	1500VDC	85%	EC3SAW	14
	9-36V, 18-72V	3.3V, 5V, 12V, 15V, +/-5V, +/-12V, +/-15V	DIP 24	500, 1500, 3000VDC	77%	EC3AW	30
	4.7-6V, 9-32V	3.3V	DIP 24	Non-Isolation	84%	EC5A	42
6W	9-18V, 18-36V, 36-72V	3.3V, 5V, 12V, 15V, +/-5V, +/-12V, +/-15V	DIP 24	500, 1500, 3000VDC	87%	EC4A	32
	9-18V, 18-36V, 36-72V	3.3V, 5V, 12V, 15V, +/-5V, +/-12V, +/-15V	DIP 24	500, 1500, 3000VDC	87%	EC4A-E	34
	9-18V, 18-36V, 36-72V	3.3V, 5V, 12V, 15V, +/-5V, +/-12V, +/-15V	DIP 24	500, 1500, 3000VDC	84%	EC4AB	36
	9-36V, 18-72V	3.3V, 5V, 12V, 15V, +/-5V, +/-12V, +/-15V	DIP 24	1500, 3000VDC	80%	EC4AW	38
	9-36V, 18-72V	5V, 12V, +/-12V, +/-15V	DIP 24	6000VDC	85%	EC4AW-H6	40
	9-36V, 18-75V	3.3V, 5V, 12V, 15V, +/-5V, +/-12V, +/-15V	SIP 8	1500VDC	87%	EC4SAW	16
	7.5W	9-18V, 18-36V, 36-72V	3.3V, 5V, 12V, 15V, +/-5V, +/-12V, +/-15V	DIP 24	1500VDC	87%	EC6A
9-18V, 18-36V, 36-72V		3.3V, 5V, 12V, 15V, +/-5V, +/-12V, +/-15V	2" x 1"	1500VDC	82%	EC3B	66
9-18V, 18-36V, 36-72V		3.3V, 5V, 12V, 15V, +/-5V, +/-12V, +/-15V	2" x 1"	1500VDC	82%	EC3BB	68
8W	9-36V, 18-75V	3.3V, 5V, 12V, 15V, +/-5V, +/-12V, +/-15V	DIP 24	1500VDC	86%	EC6AW	46
10W	4.7-9V, 9-18V, 18-36V, 36-72V	5V, 12V, 15V, +/-5V, +/-12V, +/-15V	2" x 1"	500VDC	82%	EC4B	70
	4.7-9V, 9-18V, 18-36V, 36-75V	3.3V, 5V, 12V, 15V, +/-5V, +/-12V, +/-15V	1" x 1"	1500VDC	87%	EC2SB	54
	4.7-9V, 9-18V, 18-36V, 36-75V	3.3V, 5V, 12V, 15V, +/-5V, +/-12V, +/-15V	2" x 1"	1500VDC	87%	EC4BU	76
	9-18V, 18-36V, 36-72V	5V, 12V, 15V, +/-5V, +/-12V, +/-15V	2" x 1"	500VDC	82%	EC4BE	72
	9-18V, 18-36V, 36-75V	2.5V, 3.3V, 5V, 12V, 15V, +/-12V, +/-15V	DIP 24	1500VDC	89%	EC7A	48
	9-32V	5V, 12V, 15V	DIP 24	Non-Isolation	87%	EC5A	42
	9-36V, 18-72V	3.3V, 5V, 12V, 15V, +/-5V, +/-12V, +/-15V	2" x 1"	500VDC	82%	EC4BW	74
	9-36V, 18-75V	3.3V, 5V, 12V, 15V, +/-5V, +/-12V, +/-15V	1" x 1"	1500VDC	86%	EC2SBW	56

Modified Product Support

Recognizing the requirements for matching standard products to unique applications, Cincon is dedicated to provide support for customers requiring additional features or modification to catalog products.

OUTPUT	INPUT VOLTAGE	OUTPUT VOLTAGE	PACKAGE	ISOLATION	EFF %	Series	PAGE
15W	9-18V, 18-36V, 36-72V	3.3V, 12V, 15V, +/-5V, +/-12V, +/-15V	2" x 1"	500VDC	82%	EC5B	78
	9-18V, 18-36V, 36-72V	3.3V, 12V, 15V, +/-5V, +/-12V, +/-15V	2" x 1"	500VDC	82%	EC5BE	80
	9-18V, 18-36V, 36-72V	3.3V, 5V, 12V, 15V, +/-5V, +/-12V, +/-15V	2" x 2"	500VDC	82%	EC3C	110
	9-18V, 18-36V, 36-72V	3.3V, 5V, 12V, 15V, +/-5V, +/-12V, +/-15V	2" x 2"	500VDC	82%	EC3CB	112
	9-18V, 18-36V, 36-75V	3.3V, 5V, 12V, 15V, +/-5V, +/-12V, +/-15V	1" x 1"	1500VDC	90%	EC3SB	58
	9-18V, 18-36V, 36-75V	3.3V, 5V, 12V, 15V, +/-5V, +/-12V, +/-15V	2" x 1"	1500VDC	90%	EC5BU	84
	18-36V, 36-75V	3.3V, 5V, 12V, 15V	1" x 1"	2250VDC	89%	EC1SB	52
	9-36V, 18-72V	3.3V, 5V, 12V, 15V, +/-5V, +/-12V, +/-15V, 5&+/-12V, 5&+/-15V	2" x 2"	500VDC	82%	EC5C	114
	9-36V, 18-75V	3.3V, 5V, 12V, 15V, +/-12V, +/-15V	DIP 24	1500VDC	90%	EC8AW	50
	9-36V, 18-75V	3.3V, 5V, 12V, 15V, +/-5V, +/-12V, +/-15V	1" x 1"	1500VDC	88%	EC3SBW	60
19.2W	16-32V	12V	DIP 24	Non-Isolation	93%	EC5A	42
	9-18V, 18-36V, 36-75V	1.8V, 2.5V, 3.3V, 5V, 12V, 15V, +/-12V, +/-15V	2" x 1"	1500VDC	90%	EC7B	86
20W	9-36V, 18-75V	3.3V, 5V, 12V, 15V, +/-12V, +/-15V	1" x 1"	1500VDC	89%	EC4SBW	62
	9-36V, 18-72V	3.3V, 5V, 12V, 15V, +/-5V, +/-12V, +/-15V	2" x 1.6"	1500VDC	84%	EC1SC	104
	9-36V, 18-75V	3.3V, 5V, 12V, 15V, +/-5V, +/-12V, +/-15V	2" x 1"	1500VDC	90%	EC7BW	88
	43-160V	5V, 12V, 15V, +/-12V, +/-15V	2" x 1"	2250VDC	90%	EC7BW-110	90
24W	19-32V	15V	DIP 24	Non-Isolation	94%	EC5A	42
25W	9-18V, 18-36V, 36-75V	1.8V, 2.5V, 3.3V, 5V, 12V, 15V	2" x 1.6"	1500VDC	90%	EC2SC	106
30W	9-18V, 18-36V, 36-72V	3.3V, 5V, 12V, 15V, +/-5V, +/-12V, +/-15V, 5&+/-12V, 5&+/-15V	2" x 2"	500VDC	85%	EC6C	116
	9-18V, 18-36V, 36-72V	5V, 12V, 15V, +/-12V, +/-15V, 5&+/-12V, 5&+/-15V, +5/+12/-5V	2.56" x 3"	500VDC	84%	EC5E	120
	9-18V, 18-36V, 36-75V	3.3V, 5V, 12V, 15V, +/-12V, +/-15V	2" x 1"	1500VDC	92%	EC9B	92
	9-36V, 18-72V	5V, 12V, 15V, +/-12V, +/-15V, 5&+/-12V, 5&+/-15V, +5/+12/-5V	2.56" x 3"	500VDC	84%	EC6E	122
	9-36V, 18-75V	3.3V, 5V, 12V, 15V, +/-12V, +/-15V	1" x 1"	1500VDC	88%	EC5SBW	64
40W	9-36V, 18-75V	3.3V, 5V, 12V, 15V, +/-12V, +/-15V	2" x 1"	1500VDC	92%	EC9BW	94
	9-36V, 18-75V	3.3V, 5V, 12V, 15V	2" x 1.6"	1500VDC	91%	EC3SCW	108
	9-18V, 18-36V, 36-75V	2.5V, 3.3V, 5V, 12V, 15V, +/-12V, +/-15V, 3.3&5V, 3.3&+/-12V, 3.3&+/-15V, 5&+/-12V, 5&+/-15V	2" x 2"	1500VDC	93%	EC7C	118
60W	9-36V, 18-75V	3.3V, 5V, 12V, 15V, +/-12V, +/-15V	2.05" x 1.2"	1500VDC	91%	ECLB40W	96
	43-160V	3.3V, 5V, 12V, 15V, +/-12V, +/-15V, +/-24V	2.05" x 1.2"	2250VDC	91%	ECLB40W-110	98
	9-18V, 18-36V, 36-75V	3.3V, 5V, 12V, 15V	2.05" x 1.2"	1500VDC	93%	ECLB60	100
	9-36V, 18-75V	3.3V, 5V, 12V, 15V, +/-12V, +/-15V	2.05" x 1.2"	1500VDC	92%	ECLB60W	102

EC1TA SERIES

1 WATT, UNREGULATED OUTPUT

Visit www.cincon.com for new releases and a wider selection of products

Features

- ◆ Industry Standard SIP Packages
- ◆ Efficiency up to 82%
- ◆ 1000VDC Isolation
- ◆ Low Cost
- ◆ Unregulated Outputs
- ◆ Low Ripple and Noise
- ◆ No Tantalum Capacitors Inside

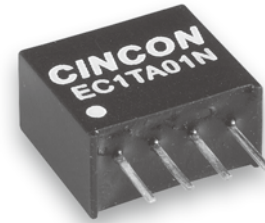

Mechanical Dimensions

All Dimensions in Inches (mm)
 Tolerance Inches Millimeters
 X.XX±0.01 X.X±0.25
 Pin ±0.002 ±0.05

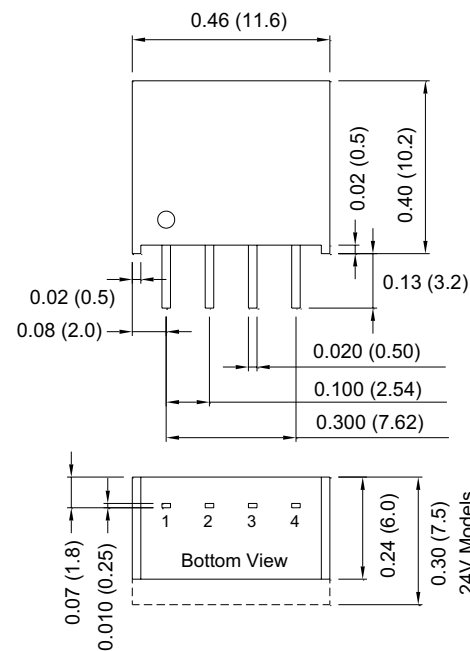

PIN CONNECTION	
PIN	Single Output
1	-V Input
2	+V Input
3	-V Output
4	+V Output

MODEL NUMBER	INPUT VOLTAGE	OUTPUT VOLTAGE	OUTPUT CURRENT	INPUT CURRENT		% EFF.	CAPACITOR LOAD MAX.
				NO LOAD	FULL LOAD		
EC1TA01N	5 VDC	5 VDC	200 mA	40 mA	253 mA	79	220µF
EC1TA02N	5 VDC	12 VDC	84 mA	40 mA	255 mA	79	220µF
EC1TA03N	5 VDC	15 VDC	67 mA	40 mA	251 mA	80	220µF
EC1TA11N	12 VDC	5 VDC	200 mA	15 mA	103 mA	81	220µF
EC1TA12N	12 VDC	12 VDC	84 mA	15 mA	103 mA	81	220µF
EC1TA13N	12 VDC	15 VDC	67 mA	15 mA	102 mA	82	220µF
EC1TA21N	24 VDC	5 VDC	200 mA	7 mA	52 mA	80	220µF
EC1TA22N	24 VDC	12 VDC	84 mA	7 mA	52 mA	80	220µF
EC1TA23N	24 VDC	15 VDC	67 mA	7 mA	52 mA	81	220µF

Derating Curve

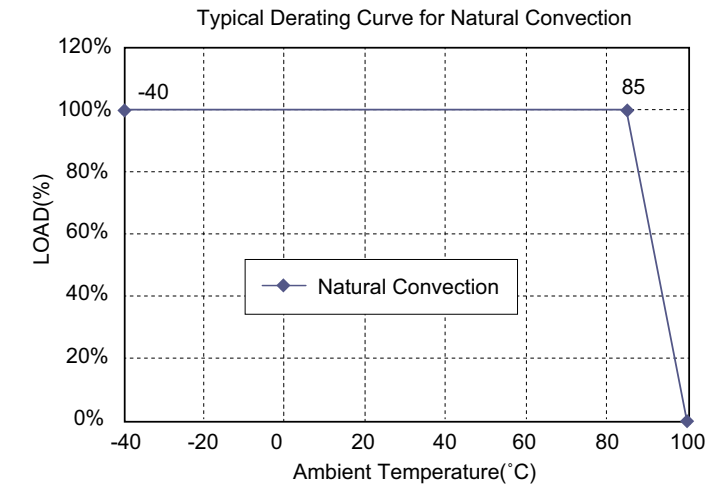

Specifications

All Specifications Typical At Nominal Line, Full Load, and 25°C Unless Otherwise Noted

INPUT SPECIFICATIONS

Input Voltage Range	±10%
Input Surge Voltage (100ms max.)	5V 9Vdc max. 12V 18Vdc max. 24V 30Vdc max.
Input Filter	Capacitive

OUTPUT SPECIFICATIONS

Voltage Accuracy	±3.0% max.
Ripple and Noise, 20MHz BW	100mV pk-pk max.
Temperature Coefficient	±0.05%/°C max.
Short Circuit Protection	Momentary 1sec. max.
Line Regulation (note 1)	±1.2% max.
Load Regulation (note 2)	±10% max.

GENERAL SPECIFICATIONS

Efficiency	See Table
Isolation Voltage	1000 VDC min.
Isolation Resistance	10 ⁹ ohm min.
Isolation Capacitance	10pF typ.
Switching Frequency	5 & 12V Input 90KHz typ. 24V Input 80KHz typ.
Operating Ambient Temperature Range	-40°C to +85°C
De-rating, Above 85°C	Linearly to Zero power at 100°C
Case temperature (note 4)	+100°C max.
Cooling	Natural Convection
Storage Temperature Range	-55°C to +125°C
Humidity	95% RH max. Non condensing
MTBF MIL-STD-217F, GB	1.7Mhrs min.
Dimensions:	
5 & 12V input	0.46 x 0.24 x 0.40 inches (11.6 x 6.0 x 10.2 mm)
24V input	0.46 x 0.30 x 0.40 inches (11.6 x 7.5 x 10.2 mm)
Case Material	Non-Conductive Black Plastic
Weight	5 & 12V Input 1.3 g 24V Input 1.7 g

NOTE

1. Line regulation is per 1.0% change in input voltage.
2. Load regulation is for load change from 100% to 20%.
3. The output noise is measured with 0.33µF ceramic capacitor.
4. Maximum case temperature under any operating condition should not be exceeded 100°C.
5. The EC1TA2XN input terminal need to parallel with 4.7µF ceramic capacitor.

EC1SA01N SERIES

1 WATT, UNREGULATED OUTPUT

Visit www.cincon.com for new releases and a wider selection of products

Features

- ◆ Industry Standard SIP Packages
- ◆ Efficiency Up to 83%
- ◆ 1000VDC Isolation
- ◆ Low Cost
- ◆ Unregulated Outputs
- ◆ Low Ripple and Noise
- ◆ No Tantalum Capacitors Inside

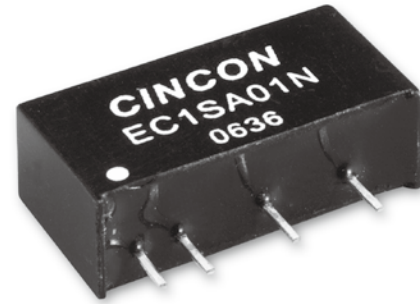

Mechanical Dimensions

All Dimensions in Inches (mm)

Tolerance	Inches	Millimeters
	X.XX±0.01	X.X±0.25
	X.XXX±0.005	X.X±0.13
Pin	±0.002	±0.05

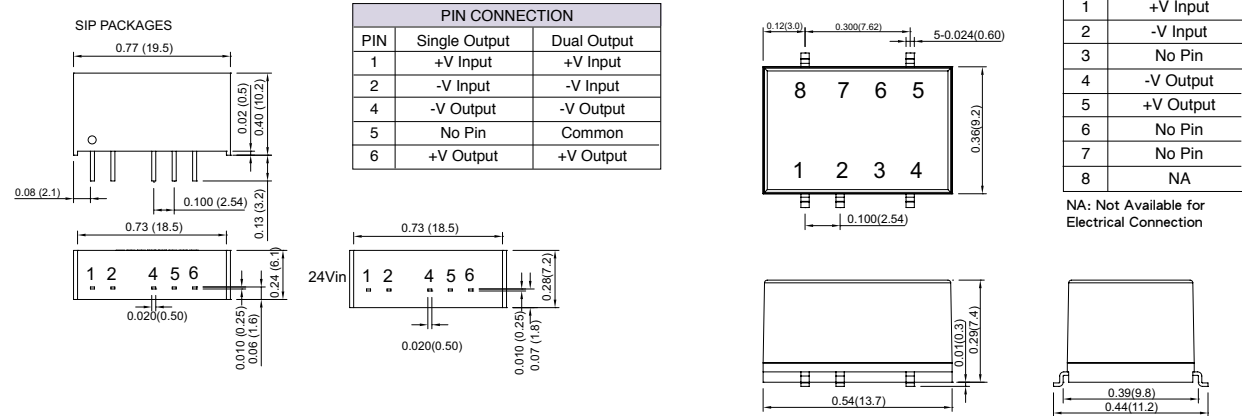

MODEL NUMBER	INPUT VOLTAGE	OUTPUT VOLTAGE	OUTPUT CURRENT	INPUT CURRENT		% EFF.	CAPACITOR LOAD MAX.
				NO LOAD	FULL LOAD		
EC1SA01N	5 VDC	5 VDC	200 mA	40 mA	253 mA	79	220µF
EC1SA02N	5 VDC	12 VDC	84 mA	40 mA	255 mA	79	220µF
EC1SA03N	5 VDC	15 VDC	67 mA	40 mA	254 mA	79	220µF
EC1SA04N	5 VDC	±12 VDC	42 mA	40 mA	258 mA	78	100µF
EC1SA05N	5 VDC	±15 VDC	33 mA	40 mA	254 mA	78	100µF
EC1SA06N	5 VDC	±5 VDC	100 mA	40 mA	270 mA	74	100µF
EC1SA11N	12 VDC	5 VDC	200 mA	15 mA	104 mA	80	220µF
EC1SA12N	12 VDC	12 VDC	84 mA	15 mA	104 mA	81	220µF
EC1SA13N	12 VDC	15 VDC	67 mA	15 mA	103 mA	81	220µF
EC1SA14N	12 VDC	±12 VDC	42 mA	15 mA	105 mA	80	100µF
EC1SA15N	12 VDC	±15 VDC	33 mA	15 mA	102 mA	81	100µF
EC1SA16N	12 VDC	±5 VDC	100 mA	15 mA	108 mA	77	100µF
EC1SA21N	24 VDC	5 VDC	200 mA	7 mA	52 mA	80	220µF
EC1SA22N	24 VDC	12 VDC	84 mA	7 mA	51 mA	83	220µF
EC1SA23N	24 VDC	15 VDC	67 mA	7 mA	52 mA	81	220µF
EC1SA24N	24 VDC	±12 VDC	42 mA	7 mA	52 mA	81	100µF
EC1SA25N	24 VDC	±15 VDC	33 mA	7 mA	50 mA	82	100µF
EC1SA26N	24 VDC	±5 VDC	100 mA	7 mA	53 mA	79	100µF

Derating Curve

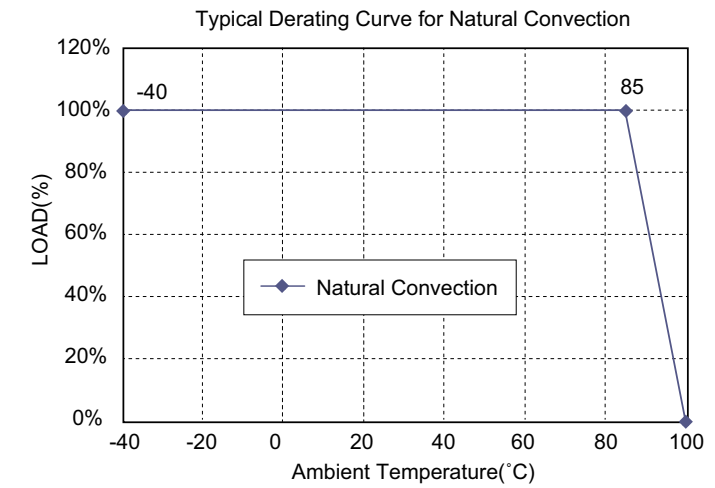

Specifications

All Specifications Typical At Nominal Line, Full Load, and 25°C Unless Otherwise Noted

INPUT SPECIFICATIONS

Input Voltage Range	±10%
Input Surge Voltage (100ms max.)	5V 9Vdc max. 12V 18Vdc max. 24V 30Vdc max.
Input Filter	Capacitive

OUTPUT SPECIFICATIONS

Voltage Accuracy	±3.0% max.
Ripple & Noise, 20MHz BW	SIP Models 75mV pk-pk max. SMD Models 120mV pk-pk max.
Temperature Coefficient	±0.05%/°C
Short Circuit Protection	Momentary 1sec. max.
Line Regulation (note 1)	±1.2% max.
Load Regulation (note 2)	±10% max.

GENERAL SPECIFICATIONS

Efficiency	See Table
Isolation Voltage	1000 VDC min.
Isolation Resistance	10 ⁹ ohm min.
Isolation Capacitance	10pF typ.
Switching Frequency	24Vin 75KHz typ. Others 100KHz typ.
Operating Ambient Temperature Range	-40°C to +85°C
De-rating, Above 85°C	Linearly to Zero power at 100°C
Case temperature (note 5)	+100°C max.
Cooling	Natural Convection
Storage Temperature Range	-55°C to +125°C
Humidity	95% RH max. Non condensing
MTBF MIL-STD-217F, GB	1.5Mhrs min.
Dimensions	SIP Models 0.77 x 0.24 x 0.40 inches (19.5 x 6.1 x 10.2 mm) SIP Models (24Vin) 0.77 x 0.28 x 0.40 inches (19.5 x 7.2 x 10.2 mm) SMD Models (Single) 0.54 x 0.36 x 0.29 inches (13.7 x 9.2 x 7.4 mm)
Case Material	Non-Conductive Black Plastic
Weight	24Vin 2.7 g Others 1.8 g

NOTE

- Line regulation is per 1.0% change in input voltage.
- Load regulation is for load change from 100% to 20%.
- The output noise is measured with 0.33µF ceramic capacitor.
- Suffix "S" to the model number with SMD packages, 5 & 12Vin models single output only.
- Maximum case temperature under any operating condition should not be exceeded 100°C.
- The EC1SA2XN input terminal need to parallel with 4.7µF ceramic capacitor.

EC2SA SERIES

2 WATT, 2:1 INPUT RANGE

Visit www.cincon.com for new releases and a wider selection of products

Features

- ◆ 2W Isolated Output
- ◆ Compact SIP-8 Package
- ◆ Efficiency to 84%
- ◆ 2 : 1 Input Range
- ◆ Regulated Outputs
- ◆ Remote On/Off Control
- ◆ 1500VDC Isolation
- ◆ Continuous Short Circuit Protection
- ◆ Under Voltage Protection
- ◆ CE Mark Meets 2004/108/EC
- ◆ Safety Meets UL60950-1, EN60950-1, and IEC60950-1



Mechanical Dimensions

All Dimensions In Inches (mm)
 Tolerance Inches Millimeters
 X.XX±0.02 X.X±0.5
 Pin ±0.002 ±0.05

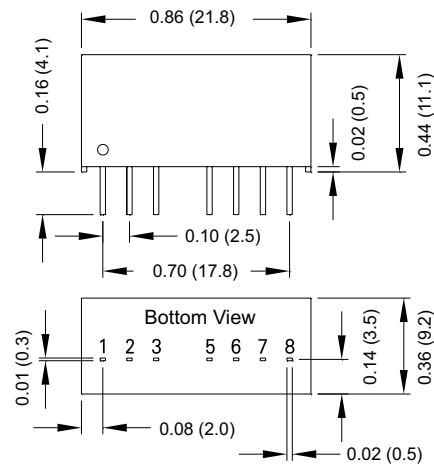

PIN CONNECTION		
PIN	Single Output	Dual Output
1	-V Input	-V Input
2	+V Input	+V Input
3	On/Off	On/Off
5	NC	NC
6	+V Output	+V Output
7	-V Output	-V Output
8	NC	NC

MODEL NUMBER	INPUT VOLTAGE	OUTPUT VOLTAGE	OUTPUT CURRENT		INPUT CURRENT		% EFF.	CAPACITOR LOAD MAX.
			MIN.	MAX.	NO LOAD	FULL LOAD		
EC2SA-05S33N	4.5-9.0 VDC	3.3 VDC	0 mA	500 mA	60 mA	452 mA	73	500µF
EC2SA-05S05N	4.5-9.0 VDC	5 VDC	0 mA	400 mA	60 mA	526 mA	76	400µF
EC2SA-05S12N	4.5-9.0 VDC	12 VDC	0 mA	167 mA	60 mA	501 mA	80	167µF
EC2SA-05S15N	4.5-9.0 VDC	15 VDC	0 mA	134 mA	60 mA	503 mA	80	134µF
EC2SA-05D05N	4.5-9.0 VDC	±5 VDC	±0 mA	±200 mA	60 mA	519 mA	77	200µF
EC2SA-05D12N	4.5-9.0 VDC	±12 VDC	±0 mA	±83 mA	60 mA	504 mA	79	83µF
EC2SA-05D15N	4.5-9.0 VDC	±15 VDC	±0 mA	±67 mA	60 mA	503 mA	80	67µF
EC2SA-12S33N	9-18 VDC	3.3 VDC	0 mA	500 mA	30 mA	181 mA	76	500µF
EC2SA-12S05N	9-18 VDC	5 VDC	0 mA	400 mA	30 mA	211 mA	79	400µF
EC2SA-12S12N	9-18 VDC	12 VDC	0 mA	167 mA	30 mA	204 mA	82	167µF
EC2SA-12S15N	9-18 VDC	15 VDC	0 mA	134 mA	30 mA	202 mA	83	134µF
EC2SA-12D05N	9-18 VDC	±5 VDC	±0 mA	±200 mA	30 mA	211 mA	79	200µF
EC2SA-12D12N	9-18 VDC	±12 VDC	±0 mA	±83 mA	30 mA	202 mA	82	83µF
EC2SA-12D15N	9-18 VDC	±15 VDC	±0 mA	±67 mA	30 mA	202 mA	83	67µF
EC2SA-24S33N	18-36 VDC	3.3 VDC	0 mA	500 mA	18 mA	90 mA	76	500µF
EC2SA-24S05N	18-36 VDC	5 VDC	0 mA	400 mA	18 mA	105 mA	79	400µF
EC2SA-24S12N	18-36 VDC	12 VDC	0 mA	167 mA	18 mA	102 mA	82	167µF
EC2SA-24S15N	18-36 VDC	15 VDC	0 mA	134 mA	18 mA	101 mA	83	134µF
EC2SA-24D05N	18-36 VDC	±5 VDC	±0 mA	±200 mA	18 mA	105 mA	79	200µF
EC2SA-24D12N	18-36 VDC	±12 VDC	±0 mA	±83 mA	18 mA	102 mA	81	83µF
EC2SA-24D15N	18-36 VDC	±15 VDC	±0 mA	±67 mA	18 mA	100 mA	84	67µF
EC2SA-48S33N	36-75 VDC	3.3 VDC	0 mA	500 mA	9 mA	46 mA	74	500µF
EC2SA-48S05N	36-75 VDC	5 VDC	0 mA	400 mA	9 mA	53 mA	79	400µF
EC2SA-48S12N	36-75 VDC	12 VDC	0 mA	167 mA	9 mA	51 mA	82	167µF
EC2SA-48S15N	36-75 VDC	15 VDC	0 mA	134 mA	9 mA	50 mA	84	134µF
EC2SA-48D05N	36-75 VDC	±5 VDC	±0 mA	±200 mA	9 mA	53 mA	78	200µF
EC2SA-48D12N	36-75 VDC	±12 VDC	±0 mA	±83 mA	9 mA	51 mA	82	83µF
EC2SA-48D15N	36-75 VDC	±15 VDC	±0 mA	±67 mA	9 mA	50 mA	84	67µF

Derating Curve

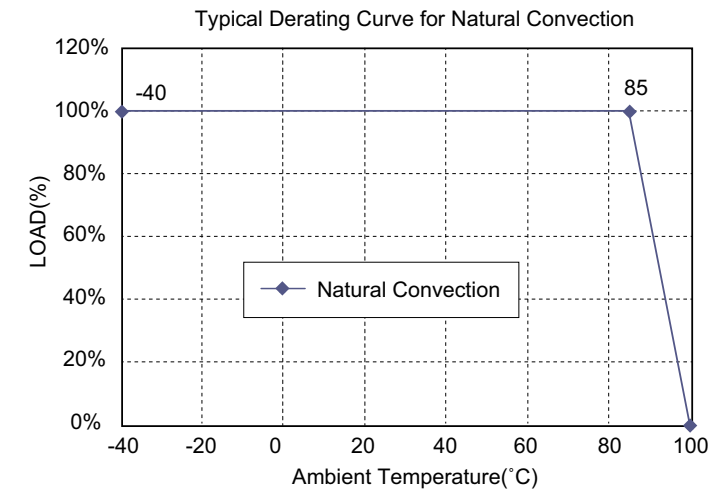

Specifications

All Specifications Typical At Nominal Line, Full Load, and 25°C Unless Otherwise Noted

INPUT SPECIFICATIONS

Input Voltage Range	5V 4.5-9V 12V 9-18V 24V 18-36V 48V 36-75V
Input Surge Voltage (100ms max.)	5V 15Vdc max. 12V 25Vdc max. 24V 50Vdc max. 48V 100Vdc max.
Under Voltage Protection (note 5):	5V _{in} Power Up4.2Vdc max. Power Down.....3Vdc min. 12V _{in} Power Up.....7.3Vdc max. Power Down.....5.8Vdc min. 24V _{in} Power Up.....15.5Vdc max. Power Down.....12Vdc min. 48V _{in} Power Up.....31Vdc max. Power Down.....24Vdc min.

Input Filter	Capacitive
Remote on/off control (note 6):	
Module Off (input idle current)	1mA max.

OUTPUT SPECIFICATIONS

Voltage Accuracy	±1.5% max.
Voltage Balance (Dual)	±1.0% max.
Cross regulation (Dual) (note 1)	Asymmetrical load 25%/100% ±5.0% max.
Transient Response: 25% Step Load Change	
Error Band	±6% V _{out} nominal
Recovery Time	< 500µs
Ripple & Noise, 20MHz BW	75mV pk-pk max.
Temperature Coefficient	±0.03%/°C
Line Regulation (note 2)	±0.5% max.
Load Regulation (note 3)	±0.5% max.
	Single Dual
Output Short Circuit Protection	Continuous
Start up time	1ms typ.

GENERAL SPECIFICATIONS

Efficiency	See Table
Isolation Voltage	1500VDC min.
Isolation Resistance	10 ⁹ ohm min.
Isolation Capacitance	500pF typ.
Switching Frequency	100KHz min.
Operating Ambient Temperature	-40°C to +85°C
De-rating, Above 85°C	Linearly to Zero power at 100°C
Case Temperature (note 4)	100°C max.
Cooling	Natural Convection
Storage Temperature	-55°C to +125°C
Humidity	95% RH max. Non condensing
MTBF MIL-STD-217F, GB, 25°C, Full Load	2500Khrs typ.
Dimensions	0.86 x 0.36 x 0.44 inches (21.80 x 9.20 x 11.10 mm)
Case Material	Non-Conductive Black Plastic
Weight	4.8 g

NOTE

1. For asymmetric loading both channels must be at 25% load or more.
2. Measured from high line to low line.
3. Measured from full load to 10% load.
4. Maximum case temperature under any operating condition should not be exceeded 100°C.
5. Suffix "N" to the model with under voltage protection.
6. Suffix "N" Models: Module On < 0.8VDC or open circuit
Module Off 4 to 15VDC
Other Models: Module On < 1.2VDC or open circuit
Module Off 5.5 to 15VDC

EC2SAN SERIES

2 WATT, UNREGULATED OUTPUTS

Visit www.cincon.com for new releases and a wider selection of products

Features

- ◆ Industry Standard SIP Packages
- ◆ Efficiency up to 86%
- ◆ 1000VDC Isolation
- ◆ Low Cost
- ◆ Unregulated Outputs
- ◆ Industry Standard Pinout
- ◆ No Tantalum Capacitors Inside

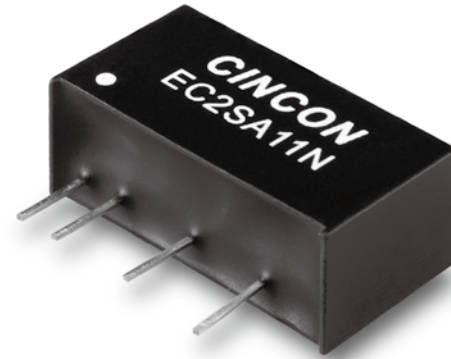

Mechanical Dimensions

All Dimensions In Inches (mm)		
Tolerance	Inches	Millimeters
	X.XX±0.01	X.X±0.25
	X.XXX±0.005	X.XX±0.13
Pin	±0.002	±0.05

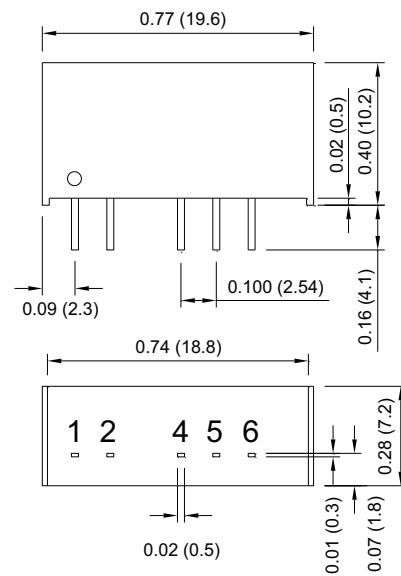

PIN CONNECTION		
PIN	Single Output	Dual Output
1	+V Input	+V Input
2	-V Input	-V Input
4	-V Output	-V Output
5	No Pin	Common
6	+V Output	+V Output

MODEL NUMBER	INPUT VOLTAGE	OUTPUT VOLTAGE	OUTPUT CURRENT	INPUT CURRENT		% EFF.	CAPACITOR LOAD MAX.
				NO LOAD	FULL LOAD		
EC2SA01N	5 VDC	5 VDC	400 mA	60 mA	488 mA	82	470µF
EC2SA02N	5 VDC	12 VDC	167 mA	60 mA	466 mA	86	470µF
EC2SA03N	5 VDC	15 VDC	134 mA	60 mA	473 mA	85	470µF
EC2SA04N	5 VDC	±12 VDC	±83 mA	60 mA	463 mA	86	470µF
EC2SA05N	5 VDC	±15 VDC	±67 mA	60 mA	467 mA	86	470µF
EC2SA06N	5 VDC	±5 VDC	±200 mA	60 mA	482 mA	83	470µF
EC2SA11N	12 VDC	5 VDC	400 mA	40 mA	203 mA	82	470µF
EC2SA12N	12 VDC	12 VDC	167 mA	40 mA	201 mA	83	470µF
EC2SA13N	12 VDC	15 VDC	134 mA	40 mA	199 mA	84	470µF
EC2SA14N	12 VDC	±12 VDC	±83 mA	40 mA	202 mA	82	470µF
EC2SA15N	12 VDC	±15 VDC	±67 mA	40 mA	199 mA	84	470µF
EC2SA16N	12 VDC	±5 VDC	±200 mA	40 mA	203 mA	82	470µF
EC2SA21N	24 VDC	5 VDC	400 mA	20 mA	105 mA	79	470µF
EC2SA22N	24 VDC	12 VDC	167 mA	20 mA	103 mA	81	470µF
EC2SA23N	24 VDC	15 VDC	134 mA	20 mA	102 mA	82	470µF
EC2SA24N	24 VDC	±12 VDC	±83 mA	20 mA	102 mA	81	470µF
EC2SA25N	24 VDC	±15 VDC	±67 mA	20 mA	102 mA	82	470µF
EC2SA26N	24 VDC	±5 VDC	±200 mA	20 mA	105 mA	79	470µF

Derating Curve

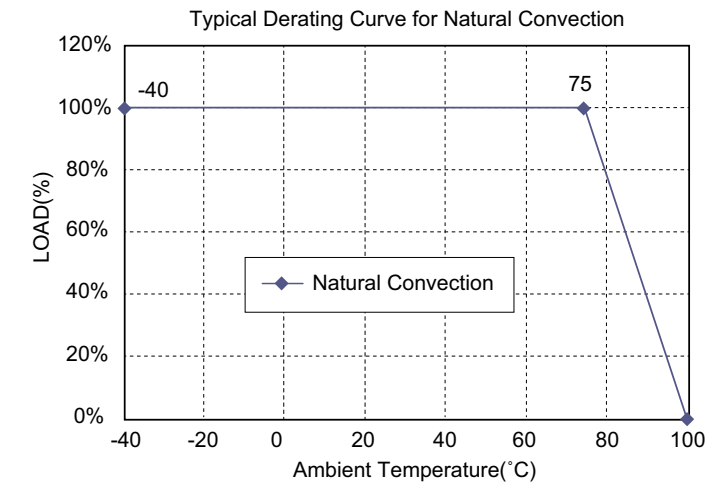

Specifications

All Specifications Typical At Nominal Line, Full Load, and 25°C Unless Otherwise Noted

INPUT SPECIFICATIONS

Input Voltage Range	±10%
Input Surge Voltage (100ms max.)	5V 9Vdc max. 12V 18Vdc max. 24V 30Vdc max. Capacitive
Input Filter	

OUTPUT SPECIFICATIONS

Voltage Accuracy	±3.0% max.
Voltage Balance (Dual)	±1.0% max.
Ripple and Noise, 20MHz BW	150mV pk-pk max.
Single output, 5V	100mVpk-pk max.
Temperature Coefficient	±0.05%/°C max.
Short Circuit Protection	Momentary 1sec. max.
Line Regulation (note 1)	±1.2% max.
Load Regulation (note 2)	±10% max.

GENERAL SPECIFICATIONS

Efficiency	See Table
Isolation Voltage	1000 VDC min.
Isolation Resistance	10 ⁹ ohm min.
Isolation Capacitance	15 pF typ.
Switching Frequency	80KHz typ.
Operating Ambient Temperature Range	-40°C to +85°C
De-rating, Above 75°C	Linearly to Zero power at 100°C
Case temperature (note 4)	+100°C max.
Cooling	Natural Convection
Storage Temperature Range	-55°C to +125°C
Humidity	95% RH max. Non condensing
MTBF MIL-STD-217F,GB	3.3Mhrs min.
Dimensions	0.77 x 0.28 x 0.40 inches (19.6 x 7.2 x 10.2 mm)
Case Material	Non-Conductive Black Plastic
Weight	2.7 g

NOTE

1. For asymmetric loading both channels must be at 25% load or more.
2. Line regulation is per 1.0% change in input voltage.
3. The output noise is measured with 0.33µF ceramic capacitor.
4. Maximum case temperature under any operating condition should not be exceeded 100°C.
5. The EC2SA2XN input terminal need to parallel with 10µF ceramic capacitor.

EC3SA SERIES

3 WATT, 2:1 INPUT RANGE

Visit www.cincon.com for new releases and a wider selection of products

Features

- ◆ 3W Isolated Output
- ◆ Compact SIP-8 Package
- ◆ Efficiency to 86%
- ◆ 2 : 1 Input Range
- ◆ Regulated Outputs
- ◆ Remote On/Off Control
- ◆ 1500VDC Isolation
- ◆ Continuous Short Circuit Protection
- ◆ Under Voltage Protection
- ◆ CE Mark Meets 2004/108/EC
- ◆ Safety Meets UL60950-1, EN60950-1, and IEC60950-1



Mechanical Dimensions

All Dimensions In Inches (mm)
 Tolerance Inches Millimeters
 X.XX±0.02 X.X±0.5
 Pin ±0.002 ±0.05

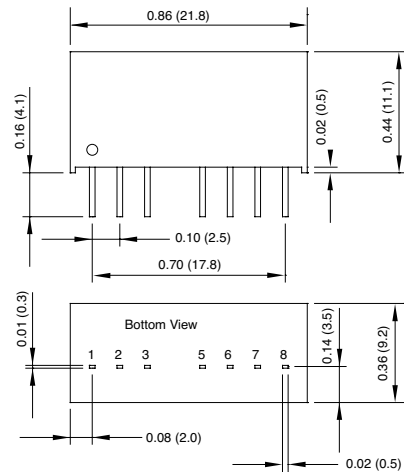

PIN CONNECTION		
PIN	Single Output	Dual Output
1	-V Input	-V Input
2	+V Input	+V Input
3	On/Off	On/Off
5	NC	NC
6	+V Output	+V Output
7	-V Output	Common
8	NC	-V Output

MODEL NUMBER	INPUT VOLTAGE	OUTPUT VOLTAGE	OUTPUT CURRENT		INPUT CURRENT		% EFF.	CAPACITOR LOAD MAX.
			MIN.	MAX.	NO LOAD	FULL LOAD		
EC3SA-05S33N	4.5-9.0 VDC	3.3 VDC	0 mA	700 mA	60 mA	632 mA	73	700µF
EC3SA-05S05N	4.5-9.0 VDC	5 VDC	0 mA	600 mA	60 mA	769 mA	78	600µF
EC3SA-05S12N	4.5-9.0 VDC	12 VDC	0 mA	250 mA	60 mA	759 mA	81	250µF
EC3SA-05S15N	4.5-9.0 VDC	15 VDC	0 mA	200 mA	60 mA	741 mA	81	200µF
EC3SA-05D05N	4.5-9.0 VDC	±5 VDC	±0 mA	±300 mA	60 mA	769 mA	78	300µF
EC3SA-05D12N	4.5-9.0 VDC	±12 VDC	±0 mA	±125 mA	60 mA	741 mA	81	125µF
EC3SA-05D15N	4.5-9.0 VDC	±15 VDC	±0 mA	±100 mA	60 mA	741 mA	81	100µF
EC3SA-12S33N	9-18 VDC	3.3 VDC	0 mA	700 mA	30 mA	253 mA	76	700µF
EC3SA-12S05N	9-18 VDC	5 VDC	0 mA	600 mA	30 mA	309 mA	81	600µF
EC3SA-12S12N	9-18 VDC	12 VDC	0 mA	250 mA	30 mA	301 mA	83	250µF
EC3SA-12S15N	9-18 VDC	15 VDC	0 mA	200 mA	30 mA	298 mA	84	200µF
EC3SA-12D05N	9-18 VDC	±5 VDC	±0 mA	±300 mA	30 mA	305 mA	82	300µF
EC3SA-12D12N	9-18 VDC	±12 VDC	±0 mA	±125 mA	30 mA	301 mA	83	125µF
EC3SA-12D15N	9-18 VDC	±15 VDC	±0 mA	±100 mA	30 mA	298 mA	84	100µF
EC3SA-24S33N	18-36 VDC	3.3 VDC	0 mA	700 mA	18 mA	125 mA	77	700µF
EC3SA-24S05N	18-36 VDC	5 VDC	0 mA	600 mA	18 mA	154 mA	81	600µF
EC3SA-24S12N	18-36 VDC	12 VDC	0 mA	250 mA	18 mA	149 mA	84	250µF
EC3SA-24S15N	18-36 VDC	15 VDC	0 mA	200 mA	18 mA	147 mA	85	200µF
EC3SA-24D05N	18-36 VDC	±5 VDC	±0 mA	±300 mA	18 mA	156 mA	80	300µF
EC3SA-24D12N	18-36 VDC	±12 VDC	±0 mA	±125 mA	18 mA	149 mA	84	125µF
EC3SA-24D15N	18-36 VDC	±15 VDC	±0 mA	±100 mA	18 mA	147 mA	85	100µF
EC3SA-48S33N	36-75 VDC	3.3 VDC	0 mA	700 mA	9 mA	63 mA	77	700µF
EC3SA-48S05N	36-75 VDC	5 VDC	0 mA	600 mA	9 mA	77 mA	81	600µF
EC3SA-48S12N	36-75 VDC	12 VDC	0 mA	250 mA	9 mA	73 mA	86	250µF
EC3SA-48S15N	36-75 VDC	15 VDC	0 mA	200 mA	9 mA	73 mA	86	200µF
EC3SA-48D05N	36-75 VDC	±5 VDC	±0 mA	±300 mA	9 mA	77 mA	81	300µF
EC3SA-48D12N	36-75 VDC	±12 VDC	±0 mA	±125 mA	9 mA	73 mA	86	125µF
EC3SA-48D15N	36-75 VDC	±15 VDC	±0 mA	±100 mA	9 mA	73 mA	86	100µF

Derating Curve

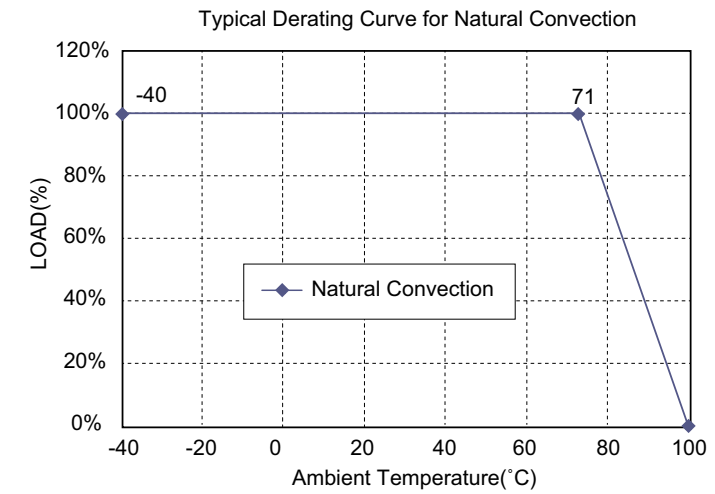

Specifications

All Specifications Typical At Nominal Line, Full Load, and 25°C Unless Otherwise Noted

INPUT SPECIFICATIONS

Input Voltage Range	5V4.5-9V 12V9-18V 24V18-36V 48V36-75V
Input Surge Voltage (100ms max.)	5V15Vdc max. 12V25Vdc max. 24V50Vdc max. 48V100Vdc max.
Under Voltage Protection (note 5):	5VIn Power Up.....4.2Vdc max. Power Down.....3Vdc min. 12VIn Power Up.....7.3Vdc max. Power Down.....5.8Vdc min. 24VIn Power Up.....15.5Vdc max. Power Down.....12Vdc min. 48VIn Power Up.....31Vdc max. Power Down.....24Vdc min. Capacitive
Input Filter	
Remote On/Off control (note 6):	
Module Off (input idle current)	1mA max.

OUTPUT SPECIFICATIONS

Voltage Accuracy	±1.5% max.
Voltage Balance (Dual)	±1.0% max.
Cross regulation (Dual) (note 1)	
Asymmetrical load 25%/100%	±5.0% max.
Transient Response: 25% Step Load Change	
Error Band	±6% Vout nominal
Recovery Time	< 500µs
Ripple & Noise 20MHz BW	75mV pk-pk max.
Temperature Coefficient	±0.03%/°C
Line Regulation (note 2)	±0.5% max.
Load Regulation (note 3)	Single ±0.5% max. Dual ±1.0% max.
Output Short Circuit Protection	Continuous
Start up time	1ms typ.

GENERAL SPECIFICATIONS

Efficiency	See Table
Isolation Voltage	1500VDC min.
Isolation Resistance	10 ⁹ ohm min.
Isolation Capacitance	500pF typ.
Switching Frequency	100KHz min.
Operating Ambient Temperature	-40°C to +85°C
De-rating, Above 71°C	Linearly to Zero power at 100°C
Case Temperature (note 4)	100°C max.
Cooling	Natural Convection
Storage Temperature	-55°C to +125°C
Humidity	95% RH max. Non condensing
MTBF MIL-STD-217F, GB, 25°C, Full Load	2500khrs typ.
Dimensions	0.86 x 0.36 x 0.44 inches (21.8 x 9.2 x 11.1 mm)
Case Material	Non-Conductive Black Plastic
Weight	4.8 g

NOTE

- For asymmetric loading both channels must be at 25% load or more.
- Measured from high line to low line.
- Measured from full load to 10% load.
- Maximum case temperature under any operating condition should not be exceeded 100°C.
- Suffix "N" to the model with under voltage protection.
- Suffix "N" Models: Module On < 0.8VDC or open circuit
Module Off 4 to 15VDC
Other Models: Module On < 1.2VDC or open circuit
Module Off 5.5 to 15VDC

EC3SAW SERIES

3 WATT, 4:1 INPUT RANGE

Visit www.cincon.com for new releases and a wider selection of products

Features

- ◆ 3W Isolated Output
- ◆ Compact SIP-8 Package
- ◆ Efficiency to 85%
- ◆ 4 : 1 Input Range
- ◆ Regulated Outputs
- ◆ Remote On/Off Control
- ◆ 1500VDC Isolation
- ◆ Continuous Short Circuit Protection
- ◆ Input Under Voltage Protection
- ◆ No Tantalum Capacitor Inside
- ◆ CE Mark Meets 2004/108/EC
- ◆ Safety Meets UL60950-1, EN60950-1, and IEC60950-1



Mechanical Dimensions

All Dimensions In Inches (mm)
 Tolerance Inches Millimeters
 X.XX±0.02 X.X±0.5
 Pin ±0.002 ±0.05

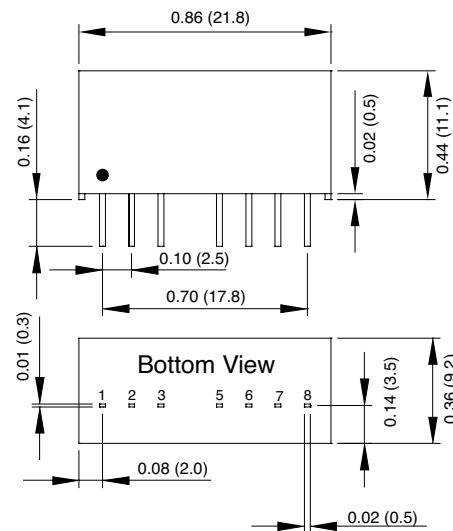

PIN CONNECTION		
PIN	Single Output	Dual Output
1	-V Input	-V Input
2	+V Input	+V Input
3	On/Off	On/Off
5	NC	NC
6	+Output	+Output
7	-Output	Common
8	NC	-Output

MODEL NUMBER	INPUT VOLTAGE	OUTPUT VOLTAGE	OUTPUT CURRENT		INPUT CURRENT		% EFF.	CAPACITOR LOAD MAX.
			MIN.	MAX.	NO LOAD	FULL LOAD		
EC3SAW-24S33P	9-36 VDC	3.3 VDC	0 mA	700 mA	4 mA	122 mA	79	1800µF
EC3SAW-24S05P	9-36 VDC	5 VDC	0 mA	600 mA	4 mA	154 mA	81	1000µF
EC3SAW-24S12P	9-36 VDC	12 VDC	0 mA	250 mA	8 mA	150 mA	84	220µF
EC3SAW-24S15P	9-36 VDC	15 VDC	0 mA	200 mA	12 mA	150 mA	84	120µF
EC3SAW-24D05P	9-36 VDC	±5 VDC	0 mA	±300 mA	8 mA	154 mA	81	470µF
EC3SAW-24D12P	9-36 VDC	±12 VDC	0 mA	±125 mA	12 mA	150 mA	84	100µF
EC3SAW-24D15P	9-36 VDC	±15 VDC	0 mA	±100 mA	12 mA	151 mA	83	47µF
EC3SAW-48S33P	18-75 VDC	3.3 VDC	0 mA	700 mA	3 mA	61 mA	79	1800µF
EC3SAW-48S05P	18-75 VDC	5 VDC	0 mA	600 mA	3 mA	76 mA	82	1000µF
EC3SAW-48S12P	18-75 VDC	12 VDC	0 mA	250 mA	5 mA	74 mA	85	220µF
EC3SAW-48S15P	18-75 VDC	15 VDC	0 mA	200 mA	5 mA	75 mA	84	120µF
EC3SAW-48D05P	18-75 VDC	±5 VDC	0 mA	±300 mA	5 mA	76 mA	82	470µF
EC3SAW-48D12P	18-75 VDC	±12 VDC	0 mA	±125 mA	10 mA	75 mA	84	100µF
EC3SAW-48D15P	18-75 VDC	±15 VDC	0 mA	±100 mA	10 mA	75 mA	83	47µF

Derating Curve

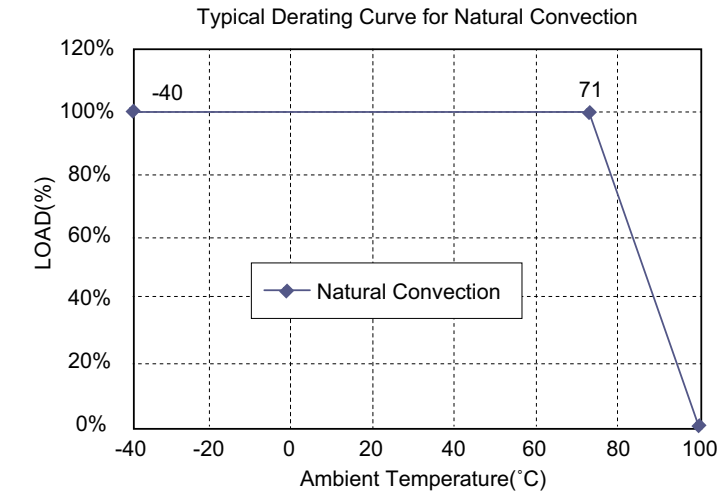

Specifications

All Specifications Typical At Nominal Line, Full Load, and 25°C Unless Otherwise Noted

INPUT SPECIFICATIONS

Input Voltage Range	24VDC 9-36VDC 48VDC 18-75VDC
Input Surge Voltage (100ms max.)	24VDC 50VDC max. 48VDC 100VDC max.
Under Voltage Protection:	
24Vin	Power Up7.5 VDC max. Power Down6 VDC min.
48Vin	Power Up15.5 VDC max. Power Down12 VDC min.
Input Filter	Capacitive
Remote On/Off Control: (Referenced to -Vin)	
Module On	Open Circuit
Module Off	< 1.2VDC
Module Off (Input Idle Current)	1mA max.

OUTPUT SPECIFICATIONS

Voltage Accuracy	±1.5% max.
Voltage Balance (Dual)	±1.0% max.
Cross Regulation (Dual)(note 4)	
Asymmetrical Load 25%/100%	±5.0% max.
Transient Response: 25% Step Load Change	
Error Band	±6% Vout nominal
Recovery Time	< 500µs
Ripple & Noise, 20MHz BW	50mV pk-pk max.
Temperature Coefficient	±0.03%/°C
Line Regulation (note 1)	±0.5% max.
Load Regulation (note 2)	±0.5% max.
	Single ±1.0% max. Dual
Output Short Circuit Protection	Continuous
Start Up Time	5ms max.

GENERAL SPECIFICATIONS

Efficiency	See Table
Isolation Voltage	1500VDC min.
Isolation Resistance	10 ⁹ ohm min.
Isolation Capacitance	500pF typ.
Switching Frequency	100KHz min.
Operating Ambient Temperature	-40°C to +85°C
De-rating, Above 71°C	Linearly to Zero Power at 100°C
Case Temperature (note 3)	100°C max.
Cooling	Natural Convection
Storage Temperature	-55°C to +125°C
Humidity	95% RH max. Non-Condensing
MTBFMIL-STD-217F, GB, 25°C, Full Load	
	Single 2800Khrs typ. Dual 2100Khrs typ.
EMI	Conductive EMI Meets EN55022 Class A & Class B (note 5)
Dimensions	0.86 x 0.36 x 0.44 inches (21.8 x 9.2 x 11.1 mm)
Case Material	Non-Conductive Black Plastic
Weight	4.8 g

NOTE

1. Measured from high line to low line.
2. Measured from full load to 10% load.
3. Maximum case temperature under any operating condition should not be exceeded 100°C.
4. For asymmetric loading both channels must be at 25% load or more.
5. The EC3SAW series meet EN55022 Class A & Class B with external C-L filter before the input pins to the converter. (see application note)

EC4SAW SERIES

5-6 WATT, 4:1 INPUT RANGE

Visit www.cincon.com for new releases and a wider selection of products

Features

- ◆ 5-6W Isolated Output
- ◆ Compact SIP-8 Package
- ◆ Efficiency to 89%
- ◆ 4 : 1 Input Range
- ◆ Regulated Outputs
- ◆ Remote On/Off Control
- ◆ 1500VDC Isolation
- ◆ Continuous Short Circuit Protection



Mechanical Dimensions

All Dimensions In Inches (mm)
 Tolerance Inches Millimeters
 X.XX±0.02 X.X±0.5
 Pin ±0.002 ±0.05

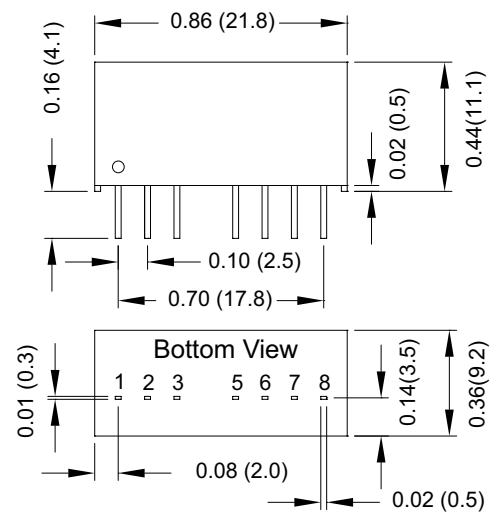

PIN CONNECTION		
PIN	Single Output	Dual Output
1	-V Input	-V Input
2	+V Input	+V Input
3	On/Off	On/Off
5	NC	NC
6	+V Output	+V Output
7	-V Output	Common
8	NC	-V Output

MODEL NUMBER	INPUT VOLTAGE	OUTPUT VOLTAGE	OUTPUT CURRENT		INPUT CURRENT		% EFF.	CAPACITOR LOAD MAX.
			MIN.	MAX.	NO LOAD	FULL LOAD		
EC4SAW-24S33N	9-36 VDC	3.3 VDC	0 mA	1500 mA	4 mA	310 mA	82	4700µF
EC4SAW-24S05N	9-36 VDC	5 VDC	0 mA	1200 mA	4 mA	298 mA	86	2200µF
EC4SAW-24S12N	9-36 VDC	12 VDC	0 mA	500 mA	5 mA	288 mA	88	1100µF
EC4SAW-24S15N	9-36 VDC	15 VDC	0 mA	400 mA	5 mA	288 mA	88	470µF
EC4SAW-24D05N	9-36 VDC	±5 VDC	0 mA	±600 mA	4 mA	298 mA	86	1400µF
EC4SAW-24D12N	9-36 VDC	±12 VDC	0 mA	±250 mA	6 mA	288 mA	88	660µF
EC4SAW-24D15N	9-36 VDC	±15 VDC	0 mA	±200 mA	6 mA	288 mA	88	220µF
EC4SAW-48S33N	18-75 VDC	3.3 VDC	0 mA	1500 mA	3 mA	155 mA	82	4700µF
EC4SAW-48S05N	18-75 VDC	5 VDC	0 mA	1200 mA	3 mA	150 mA	85	2200µF
EC4SAW-48S12N	18-75 VDC	12 VDC	0 mA	500 mA	3 mA	145 mA	89	1100µF
EC4SAW-48S15N	18-75 VDC	15 VDC	0 mA	400 mA	3 mA	145 mA	88	470µF
EC4SAW-48D05N	18-75 VDC	±5 VDC	0 mA	±600 mA	4 mA	150 mA	85	1400µF
EC4SAW-48D12N	18-75 VDC	±12 VDC	0 mA	±250 mA	3 mA	145 mA	89	660µF
EC4SAW-48D15N	18-75 VDC	±15 VDC	0 mA	±200 mA	3 mA	145 mA	89	220µF

Derating Curve

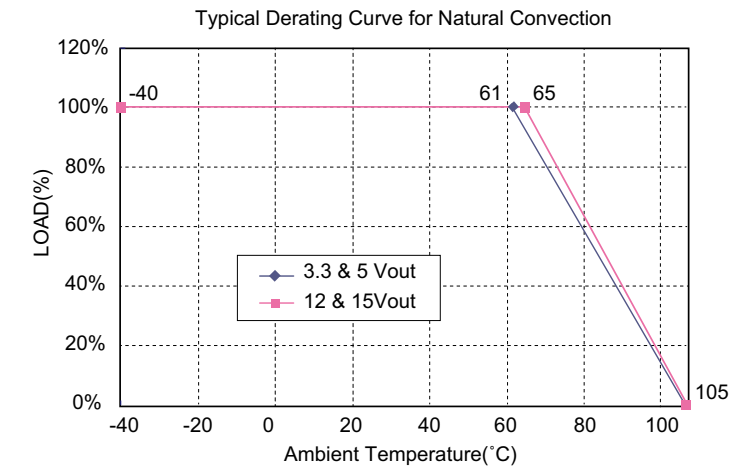

Specifications

All Specifications Typical At Nominal Line, Full Load, and 25°C Unless Otherwise Noted

INPUT SPECIFICATIONS

Input Voltage Range	24V 9-36V 48V 18-75V
Input Surge Voltage (100 ms max.)	24V 50VDC max. 48V 100VDC max.
Input Filter	Capacitive
Remote On/Off control:	Open or high impedance
Module On	2mA to 4mA
Module Off	2.5mA max.
Module Off (input idle current)	

OUTPUT SPECIFICATIONS

Voltage Accuracy	±1.5% max.
Voltage Balance (Dual)	±1.0% max
Transient Response: 25% Step Load Change	
Error Band	±5% Vout nominal
Recovery Time	< 250µs
Ripple & Noise, 20MHz BW	100mV pk-pk max.
Temperature Coefficient	±0.03%/°C
Short Circuit Protection	Continuous
Line Regulation (note 1)	±0.2% max.
Load Regulation (note 2)	±0.5% max.
	Single Dual
	±1.0% max.
Cross regulation (Dual note 3)	
Asymmetrical load 25%/100%	±5.0% max.
Current Limit	180% typ.
Start up time	15ms typ.

GENERAL SPECIFICATIONS

Efficiency	See Table
Isolation Voltage	1500VDC min.
Isolation Resistance	10 ⁹ ohm min.
Isolation Capacitance	50pF max.
Switching Frequency	580KHz typ.
Operating Ambient Temperature	-40°C to +85°C
De-rating, Above 61°C.....	3.3V/5V Linearly to Zero power at 105°C
De-rating, Above 65°C.....	12V/15V Linearly to Zero power at 105°C
Case Temperature (note 3)	105°C max.
Cooling	Natural Convection
Storage Temperature	-55°C to +125°C
Humidity	95% RH max. Non condensing
MTBF.....MIL-STD-217F, GB, 25°C, Full Load	1850Khrs typ.
Dimensions	0.86 x 0.36 x 0.44 inches (21.8 x 9.2 x 11.1 mm)
Case Material	Non-Conductive Black Plastic
Weight	4.8 g

NOTE

1. Measured from high line to low line.
1. Measured from high line to low line.
2. Measured from full load to no load.
3. For asymmetric loading, both channels must be at 25% load or more.
4. Maximum case temperature under any operating condition should not be exceeded 105°C.

Features

- ◆ 1-2W Output Power
- ◆ DIP-24/SMD Package
- ◆ Pi Input Filter
- ◆ Input Voltage 5V & 12V
- ◆ Full Power to +71°C

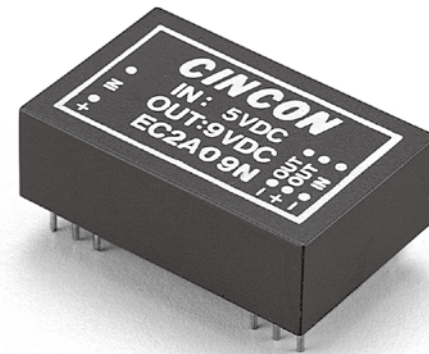

Not Recommended For New Designs

Mechanical Dimensions

NOTE: Pin Size is 0.02" Inch (0.5mm) DIA±0.05
All Dimensions In Inches (mm)
Tolerance Inches: X.XX±0.02, X.XXX±0.010
Millimeters: X.X±0.5, X.X X±0.25

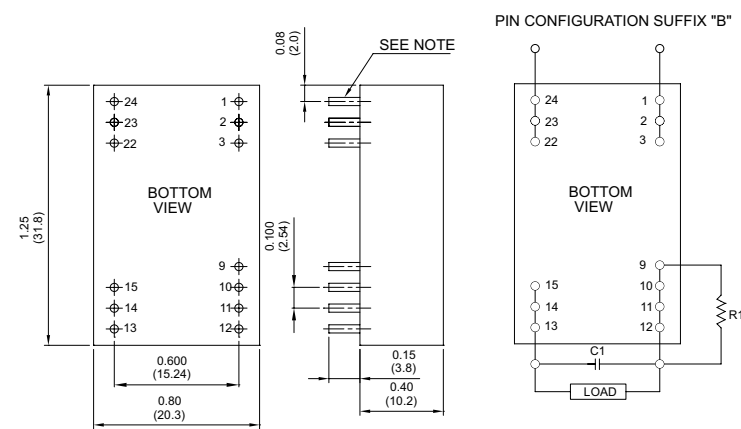

Pin	A	B
1	+V Input	+V Input
2	NC*	+V Input
3	NC*	+V Input
9	No Pin	Resistor
10	-V Output	+V Output
11	+V Output	+V Output
12	-V Input	+V Output
13	-V Input	-V Output
14	+V Output	-V Output
15	-V Output	-V Output
22	NC*	-V Input
23	NC*	-V Input
24	+V Input	-V Input

* External Resistor R1
* C1=10.0µF 25V Tantalum Capacitor
* R1=100Ω
* NC=No Connection (With Pin)
C1 will improve output noise performance.
It is not required for converter operation.
Regulated units only (EC2A09M, EC2A19M).
Pin 9 provides a preregulated output voltage, which when used as shown above provides for a full load output current of 140mA, when load current is less than 60mA output voltage will rise and for a no load condition it can rise to approximately 13 volts.

Derating Curve

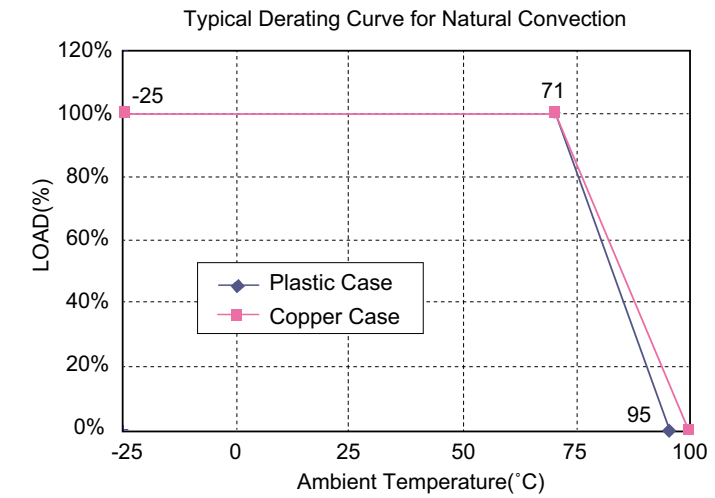

Specifications

All Specifications Typical At Nominal Line, Full Load, and 25°C Unless Otherwise Noted

INPUT SPECIFICATIONS

Input Voltage	5 or 12VDC
Input Voltage Range	±10%
Input Filter	Pi Type

OUTPUT SPECIFICATIONS

Output Voltage	9 VDC
	+10 VDC
	+5 VDC
Voltage Accuracy 9 VDC	±5.0% max.
+10 VDC	±4.0%
+5 VDC	±2.0%
Ripple & Noise, 20MHz BW 9VDC	100mV p-p
	300mV p-p
	300mV p-p
	Momentary
Short Circuit Protection	
Line Regulation	
Regulated Models	±0.3%
Unregulated Models (note 1)	±1.2%
Load Regulation	
Regulated Models (note 2)	±0.5%
Unregulated Models (note 3)	±6.0%

GENERAL SPECIFICATIONS

Efficiency	
Regulated Models	50%
Unregulated Models	70%
Switching Frequency	20KHz min.
Isolation Voltage	500 VDC min.
Operating Ambient Temperature Range	-25°C to +71°C
De-rating, Above 71°C (Plastic Case)	Linearly to Zero power at 95°C
De-rating, Above 71°C (Copper Case)	Linearly to Zero power at 100°C
Case Temperature (Plastic case note 4)	95°C max.
(Copper case note 4)	100°C max.
Cooling	Natural Convection
Storage Temperature Range	-40°C to +85°C
Dimensions	1.25 × 0.80 × 0.40 inches (31.8 × 20.3 × 10.2 mm)
Case Material	Non-Conductive Black Plastic
Suffix "M" Model	Black Coated Copper with Non-Conductive Base
Weight	12.5 g

NOTE

1. Per 1% change in input voltage.
2. For a load change from 60mA to 140mA.
3. For a load change from 100% full load to 20% full load.
4. Maximum case temperature under any operating condition should not be exceeded 95°C (Plastic Case), 100°C (Copper Case).

MODEL NUMBER	INPUT VOLTAGE	OUTPUT VOLTAGE	OUTPUT CURRENT	INPUT CURRENT		PIN CONN.
				NO LOAD	FULL LOAD	
REGULATED						
EC2A09M	5VDC	9VDC	140 mA	120 mA	540 mA	B
EC2A19M	12VDC	9VDC	140 mA	45 mA	215 mA	B
UNREGULATED						
EC2A09N	5VDC	9VDC	250 mA	100 mA	600 mA	A
EC2A19N	12VDC	9VDC	250 mA	40 mA	260 mA	A

EC2A SERIES

1.5 WATT

Visit www.cincon.com for new releases and a wider selection of products

Features

- ◆ 1.5W Output Power
- ◆ DIP-24/SMD Package
- ◆ Efficiency to 50%
- ◆ Regulated Outputs
- ◆ PI Input Filter
- ◆ Low Ripple and Noise

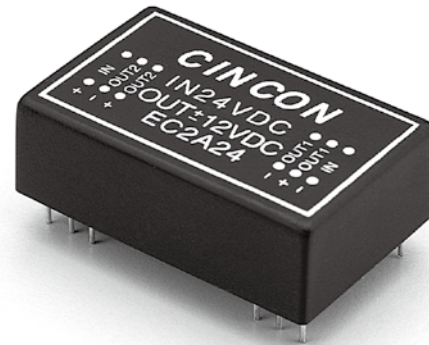

Mechanical Dimensions

NOTE: Pin Size is 0.02" Inch (0.5mm) DIA±0.05
All Dimensions in Inches (mm)
Tolerance Inches: X.XX=±0.02, X.XXX=±0.010
Millimeters: X.X=±0.5, X.XX=±0.25

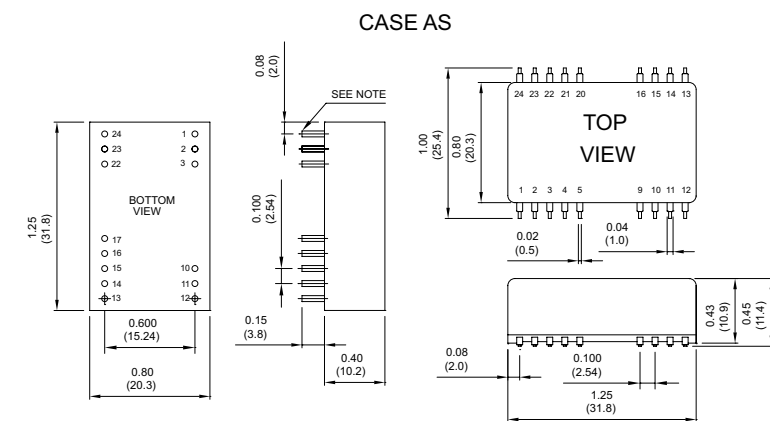

PIN CONNECTION									
500 VDC					1.5K & 3K VDC				
Pin	Single Output		Dual Output		Pin	Single Output		Dual Output	
	DIP	SMD	DIP	SMD		DIP	SMD	DIP	SMD
1,24	+V Input	+V Input	+V Input	+V Input	1,2,3	+V Input	+V Input	+V Input	+V Input
2,23	NC	-V Output	-V Output	-V Output	22,23,24	-V Input	-V Input	-V Input	-V Input
3,22	NC	Common	Common	Common	4	NP	NC	NP	NC
4,5	NP	NC	NP	NC	5	NP	NC	NP	NC
9	NP	NC	NP	NC	9	NP	NC	Common	Common
11	+V Output	+V Output	+V Output	+V Output	12	-V Output	-V Output	-TP	-TP
12,13	-V Input	-V Input	-V Input	-V Input	13	+V Output	+V Output	-V Output	-V Output
14	+V Output	+V Output	+V Output	+V Output	14	NP	NC	NP	NC
15	-V Output	Common	Common	Common	15	NP	NC	+V Output	+V Output
16	NP	NC	NP	NC	16	NP	NC	+TP	+TP
17	NP	NP	NP	NP	17	+TP	NP	NP	NP
20,21	NP	NC	NP	NC	20,21	NP	NC	NP	NC

* NP-NO PIN * TP-TEST POINT
* NC-NO CONNECTION WITH PIN

Derating Curve

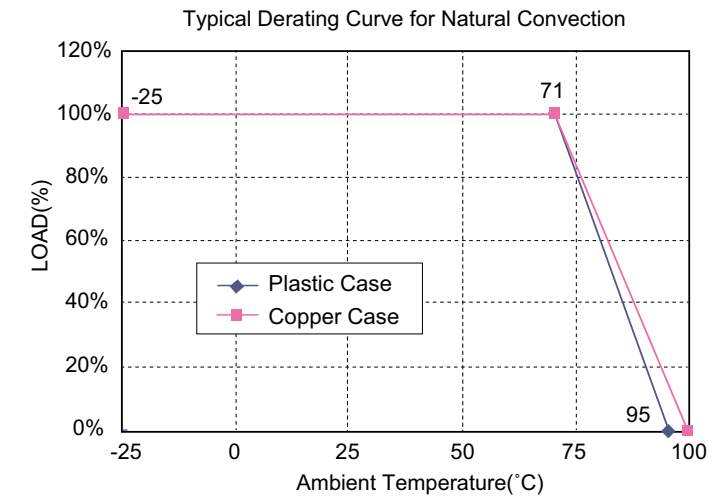

Specifications

All Specifications Typical At Nominal Line, Full Load, and 25°C Unless Otherwise Noted

INPUT SPECIFICATIONS

Input Voltage Range ±10%
Input Filter PI Type

ISOLATION VOLTAGE

500 VDC min. Standard Models
3KVDC min. Suffix "H" Models
1.5KVDC min. Suffix "HM" Models

OUTPUT SPECIFICATIONS

Voltage Accuracy ±4.0% max.
Temperature coefficient ±0.02%/°C
Ripple & Noise, 20MHz BW 50mV pk-pk max.
Short Circuit Protection Momentary
Line Regulation ±0.3%
Load Regulation ±0.5%

CASE MATERIAL

Standard Models Non-Conductive Black Plastic
Suffix "M" Models Black Coated Copper with Non-Conductive Base

NOTE

- Suffix "S" to the model number with SMD packages.
- Maximum case temperature under any operating condition should not be exceeded 95°C (Plastic Case), 100°C (Copper Case).

GENERAL SPECIFICATIONS

Efficiency 50%
Isolation Capacitance 30pF
Isolation Resistance 10⁹ ohm
Switching Frequency 20KHz min.
Operating Ambient Temperature Range -25°C to +71°C
De-rating, Above 71°C (Plastic Case) Linearly to Zero power at 95°C
De-rating, Above 71°C (Copper Case) Linearly to Zero power at 100°C
Case Temperature (Plastic case note 2) 95°C max.
(Copper case note 2) 100°C max.
Cooling Natural Convection
Storage Temperature Range -40°C to +100°C
Dimensions DIP 1.25 x 0.80 x 0.40 inches (31.8 x 20.3 x 10.2 mm)
SMD 1.25 x 0.80 x 0.45 inches (31.8 x 20.3 x 11.4 mm)
Weight 12.5 g

MODEL NUMBER	INPUT VOLTAGE	OUTPUT VOLTAGE	OUTPUT CURRENT	INPUT CURRENT	
				NO LOAD	FULL LOAD
EC2A01	5 VDC	5 VDC	300 mA	110 mA	620 mA
EC2A02	5 VDC	12 VDC	125 mA	110 mA	550 mA
EC2A03	5 VDC	15 VDC	100 mA	110 mA	550 mA
EC2A04	5 VDC	±12 VDC	±60 mA	110 mA	550 mA
EC2A05	5 VDC	±15 VDC	±50 mA	110 mA	550 mA
EC2A11	12 VDC	5 VDC	300 mA	40 mA	260 mA
EC2A12	12 VDC	12 VDC	125 mA	40 mA	215 mA
EC2A13	12 VDC	15 VDC	100 mA	40 mA	215 mA
EC2A14	12 VDC	±12 VDC	±60 mA	40 mA	215 mA
EC2A15	12 VDC	±15 VDC	±50 mA	40 mA	215 mA
EC2A21	24 VDC	5 VDC	300 mA	20 mA	130 mA
EC2A22	24 VDC	12 VDC	125 mA	20 mA	115 mA
EC2A23	24 VDC	15 VDC	100 mA	20 mA	115 mA
EC2A24	24 VDC	±12 VDC	±60 mA	20 mA	115 mA
EC2A25	24 VDC	±15 VDC	±50 mA	20 mA	115 mA
EC2A31	28 VDC	5 VDC	300 mA	20 mA	110 mA
EC2A32	28 VDC	12VDC	125 mA	20 mA	100 mA
EC2A33	28 VDC	15 VDC	100 mA	20 mA	100 mA
EC2A34	28 VDC	±12 VDC	±60 mA	20 mA	100 mA
EC2A35	28 VDC	±15 VDC	±50 mA	20 mA	100 mA
EC2A41	48 VDC	5 VDC	300 mA	15 mA	65 mA
EC2A42	48 VDC	12 VDC	125 mA	15 mA	60 mA
EC2A43	48 VDC	15 VDC	100 mA	15 mA	60 mA
EC2A44	48 VDC	±12 VDC	±60 mA	15 mA	60 mA
EC2A45	48 VDC	±15 VDC	±50 mA	15 mA	60 mA

EC3A SERIES

3 WATT, 2:1 INPUT RANGE

Visit www.cincon.com for new releases and a wider selection of products

Features

- ◆ 3W Isolated Output
- ◆ DIP-24/SMD Package
- ◆ Efficiency to 82%
- ◆ 2 : 1 Input Range
- ◆ Regulated Outputs
- ◆ Pi Input Filter
- ◆ Continuous Short Circuit Protection
- ◆ UL60950-1 Approval for H/HM Versions only

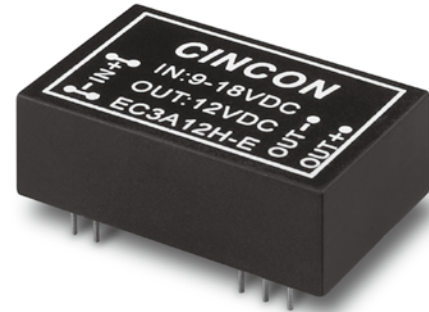

Mechanical Dimensions

NOTE: Pin Size is 0.02" Inch (0.5mm) DIA
All Dimensions in Inches (mm)
Tolerance Inches: X.XX=±0.02, X.XXX=±0.010
Millimeters: X.X=±0.5, X.XX=±0.25

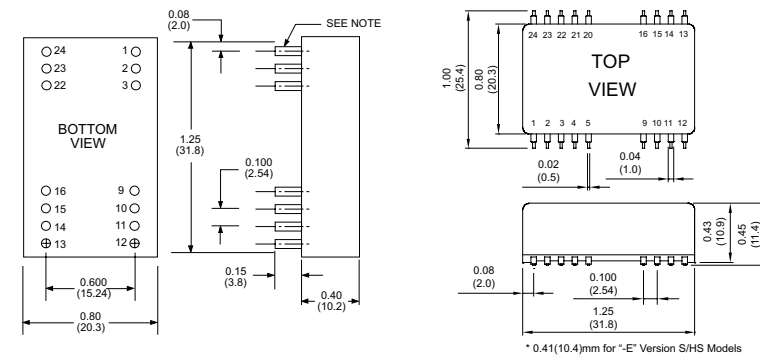

PIN CONNECTION									
500 VDC				1.5K & 3K VDC					
Pin	Single Output		Dual Output		Pin	Single Output		Dual Output	
	DIP	SMD	DIP	SMD		DIP	SMD	DIP	SMD
1,24	+V Input		+V Input		1,24	NP	NC	NP	NC
2,23	NC		-V Output		2,3	-V Input		-V Input	
3,22	NC		Common		4,5	NP	NC	NP	NC
4	NP	NC	NP	NC	9	NC		Common	
5	NP	NC	NP	NC	10,15	NC		NC	
9	NP	NC	NP	NC	11	NC		-V Output	
10,15	-V Output		Common		12,13	NP	NC	-V Output	
11,14	+V Output		+V Output		14	+V Output		NP	NC
12,13	-V Input		-V Input		16	-V Output		Common	
16	NP	NC	NP	NC	20,21	NP	NC	NP	NC
20,21	NP	NC	NP	NC	22,23	+V Input		+V Input	

* NP-NO PIN
* NC-NO CONNECTION WITH PIN

MODEL NUMBER	INPUT VOLTAGE	OUTPUT VOLTAGE	OUTPUT CURRENT	INPUT CURRENT		% EFF.	CAPACITOR LOAD MAX.
				NO LOAD	FULL LOAD		
EC3A01	4.5-6 VDC	5 VDC	600 mA	15 mA	800 mA	75	2200µF
EC3A02	4.5-6 VDC	12 VDC	250 mA	15 mA	759 mA	79	2200µF
EC3A03	4.5-6 VDC	15 VDC	200 mA	15 mA	779 mA	77	2200µF
EC3A04	4.5-6 VDC	±5 VDC	±300 mA	25 mA	779 mA	77	1000µF
EC3A05	4.5-6 VDC	±12 VDC	±125 mA	25 mA	789 mA	76	1000µF
EC3A06	4.5-6 VDC	±15 VDC	±100 mA	25 mA	800 mA	75	1000µF
EC3A07	4.5-6 VDC	3.3 VDC	600 mA	15 mA	582 mA	68	2200µF
EC3A11	9-18 VDC	5 VDC	600 mA	7.5 mA	325 mA	77	2200µF
EC3A12	9-18 VDC	12 VDC	250 mA	7.5 mA	313 mA	80	2200µF
EC3A13	9-18 VDC	15 VDC	200 mA	7.5 mA	316 mA	79	2200µF
EC3A14	9-18 VDC	±5 VDC	±300 mA	12 mA	325 mA	77	1000µF
EC3A15	9-18 VDC	±12 VDC	±125 mA	12 mA	325 mA	77	1000µF
EC3A16	9-18 VDC	±15 VDC	±100 mA	12 mA	316 mA	79	1000µF
EC3A17	9-18 VDC	3.3 VDC	600 mA	7.5 mA	229 mA	72	2200µF
EC3A21	18-36 VDC	5 VDC	600 mA	5 mA	158 mA	79	2200µF
EC3A22	18-36 VDC	12 VDC	250 mA	5 mA	156 mA	80	2200µF
EC3A23	18-36 VDC	15 VDC	200 mA	5 mA	152 mA	82	2200µF
EC3A24	18-36 VDC	±5 VDC	±300 mA	7.5 mA	162 mA	77	1000µF
EC3A25	18-36 VDC	±12 VDC	±125 mA	7.5 mA	158 mA	79	1000µF
EC3A26	18-36 VDC	±15 VDC	±100 mA	7.5 mA	154 mA	81	1000µF
EC3A27	18-36 VDC	3.3 VDC	600 mA	5 mA	111 mA	74	2200µF
EC3A31	36-72 VDC	5 VDC	600 mA	2 mA	78 mA	79	2200µF
EC3A32	36-72 VDC	12 VDC	250 mA	2 mA	78 mA	80	2200µF
EC3A33	36-72 VDC	15 VDC	200 mA	2 mA	78 mA	80	2200µF
EC3A34	36-72 VDC	±5 VDC	±300 mA	3 mA	80 mA	78	1000µF
EC3A35	36-72 VDC	±12 VDC	±125 mA	3 mA	80 mA	78	1000µF
EC3A36	36-72 VDC	±15 VDC	±100 mA	3 mA	80 mA	78	1000µF
EC3A37	36-72 VDC	3.3 VDC	600 mA	3 mA	57 mA	72	2200µF

Derating Curve

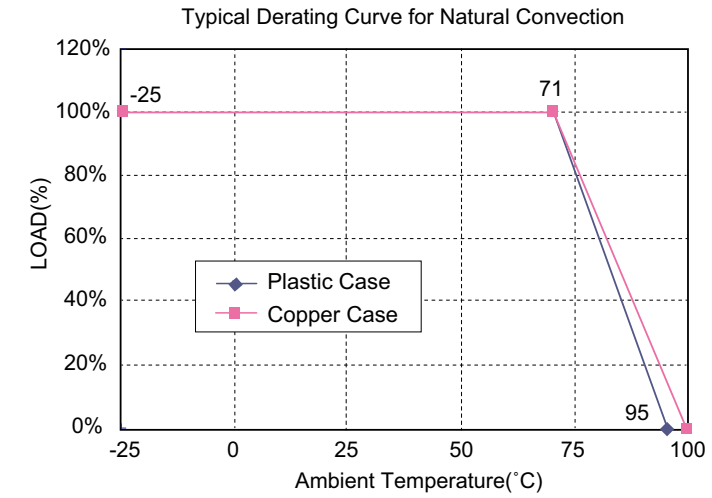

Specifications

All Specifications Typical At Nominal Line, Full Load, and 25°C Unless Otherwise Noted

INPUT SPECIFICATIONS

Input Voltage Range	5V4.5-6V 12V 9-18V 24V 18-36V 48V 36-72V 5V 10Vdc max. 12V 25Vdc max. 24V 50Vdc max. 48V 100Vdc max.
Input Surge Voltage (100ms max.)	PI Type
Input Filter	

OUTPUT SPECIFICATIONS

Voltage Accuracy	±2.0% max.
Voltage Balance (Dual)	±1.0% max.
Temperature Coefficient	±0.05%/°C
Ripple & Noise, 20MHz BW	3.3V/5V ...100mV pk-pk, max. 12V/15V1% pk-pk max.
Short Circuit Protection	Continuous
Line Regulation	Single/Dual (note 1) ±0.5% max.
Load Regulation	Single (note 2) ±0.5% max. Dual (note 3) ±1.0% max.

GENERAL SPECIFICATIONS

Efficiency	See Table
Isolation Voltage:	500 VDC min. 3K VDC min.
Isolation Resistance	1.5K VDC min. 10 ⁹ ohm min.
Switching Frequency	100KHz min.
Operating Ambient Temperature Range	-25°C to +71°C
Power de-rating Curve	see Figure1
Case Temperature (note 4)	Plastic/Copper case 95°C/100°C max. Natural Convection -40°C to +100°C
Cooling	95% RH max. Non condensing
Storage Temperature Range	2000khrs typ.
Humidity	1.25 x 0.80 x 0.45 inches (31.8 x 20.3 x 10.2 mm)
MTBF MIL-STD-217F	1.25 x 0.80 x 0.45 inches (31.8 x 20.3 x 11.4 mm)
Dimensions	DIP
Case Material:	SMD
Standard Models	Non-Conductive Black Plastic
Suffix "M" Models	Black Coated Copper with Non-Conductive Base
Weight	12.5 g

NOTE

1. Measured from high line to low line.
2. Measured from full load to 10% load.
3. Measured from full load to 1/4 load.
4. Maximum case temperature under any operating condition should not be exceed 95°C (Plastic Case), 100°C (Copper Case).

Features

- ◆ 3W Isolated Output
- ◆ DIP-24/SMD Package
- ◆ Efficiency to 61%
- ◆ Regulated Outputs
- ◆ LC Input Filter
- ◆ Low Ripple and Noise

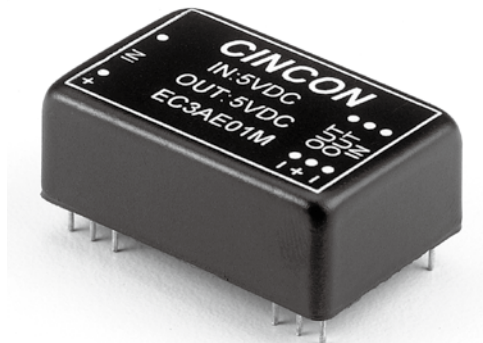

Mechanical Dimensions

NOTE: Pin Size is 0.02" Inch (0.5mm) DIA
 All Dimensions in Inches (mm)
 Tolerance Inches: X.XX=±0.02, X.XXX=±0.010
 Millimeters: X.X=±0.5, X.XX=±0.25

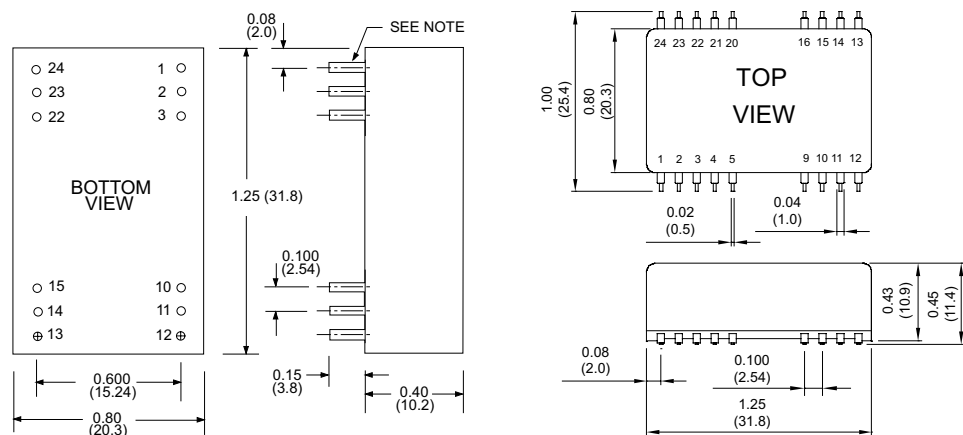

PIN CONNECTION				
Pin	Single Output		Dual Output	
	DIP	SMD	DIP	SMD
1,24	+V Input		+V Input	
2,23	NC		-V Output	
3,22	NC		Common	
4	NP	NC	NP	NC
5	NP	NC	NP	NC
9	NP	NC	NP	NC
10,15	-V Output		Common	
11,14	+V Output		+V Output	
12,13	-V Input		-V Input	
16	NP	NC	NP	NC
20,21	NP	NC	NP	NC

* NP-NO PIN
 * NC-NO CONNECTION WITH PIN

Derating Curve

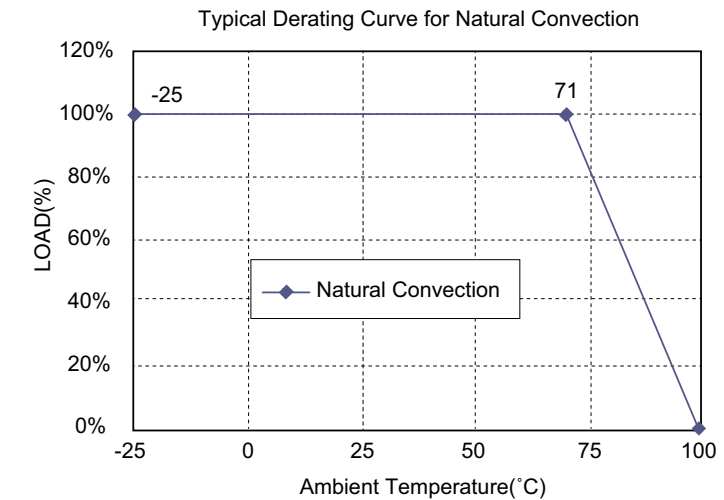

Specifications

All Specifications Typical At Nominal Line, Full Load, and 25°C Unless Otherwise Noted

INPUT SPECIFICATIONS

Input Voltage Range ±10%
 Input Filter LC Type

OUTPUT SPECIFICATIONS

Voltage Accuracy ±3.0% max.
 Temperature coefficient ±0.02%/°C
 Ripple & Noise, 20MHz BW 50mV pk-pk max.
 Short Circuit Protection Indefinite & Current Limit
 Line Regulation (note 1) ±0.3% max.
 Load Regulation (note 2) Single ±0.5% max.
 Dual ±1.0% max.

ISOLATION VOLTAGE

500 VDC min. Standard Models

CASE MATERIAL

Standard Models Black Coated Copper with Non-Conductive Base

NOTE

1. Measured from high line to low line.
2. Measured from full load to 10% load.
3. Suffix "S" to the model number with SMD packages.
4. Maximum case temperature under any operating condition should not be exceeded 100°C.

GENERAL SPECIFICATIONS

Efficiency See Table
 Isolation Capacitance 150pF typ.
 Isolation Resistance 10⁹ ohm min.
 Switching Frequency 80KHz typ.
 Operating Ambient Temperature Range -25°C to +71°C
 De-rating, Above 71°C Linearly to Zero power at 100°C
 Case Temperature (note 4) 100°C max.
 Cooling Natural Convection
 Storage Temperature Range -40°C to +100°C
 Dimensions DIP 1.25 x 0.80 x 0.40 inches (31.8 x 20.3 x 10.2 mm)
 SMD 1.25 x 0.80 x 0.45 inches (31.8 x 20.3 x 11.4 mm)
 Weight 17.2 g

MODEL NUMBER	INPUT VOLTAGE	OUTPUT VOLTAGE	OUTPUT CURRENT	INPUT CURRENT		% EFF.
				NO LOAD	FULL LOAD	
EC3AE01M	5 VDC	5 VDC	600 mA	120 mA	984 mA	61
EC3AE02M	5 VDC	12 VDC	250 mA	120 mA	984 mA	61
EC3AE03M	5 VDC	15 VDC	200 mA	120 mA	984 mA	61
EC3AE04M	5 VDC	±12 VDC	±125 mA	120 mA	984 mA	61
EC3AE05M	5 VDC	±15 VDC	±100 mA	120 mA	984 mA	61
EC3AE11M	12 VDC	5 VDC	600 mA	60 mA	410 mA	61
EC3AE12M	12 VDC	12 VDC	250 mA	60 mA	410 mA	61
EC3AE13M	12 VDC	15 VDC	200 mA	60 mA	410 mA	61
EC3AE14M	12 VDC	±12 VDC	±125 mA	60 mA	410 mA	61
EC3AE15M	12 VDC	±15 VDC	±100 mA	60 mA	410 mA	61
EC3AE21M	24 VDC	5 VDC	600 mA	40 mA	205 mA	61
EC3AE22M	24 VDC	12 VDC	250 mA	40 mA	205 mA	61
EC3AE23M	24 VDC	15 VDC	200 mA	40 mA	205 mA	61
EC3AE24M	24 VDC	±12 VDC	±125 mA	40 mA	205 mA	61
EC3AE25M	24 VDC	±15 VDC	±100 mA	40 mA	205 mA	61
EC3AE31M	28 VDC	5 VDC	600 mA	35 mA	176 mA	61
EC3AE32M	28 VDC	12 VDC	250 mA	35 mA	176 mA	61
EC3AE33M	28 VDC	15 VDC	200 mA	35 mA	176 mA	61
EC3AE34M	28 VDC	±12 VDC	±125 mA	35 mA	176 mA	61
EC3AE35M	28 VDC	±15 VDC	±100 mA	35 mA	176 mA	61
EC3AE41M	48 VDC	5 VDC	600 mA	20 mA	102 mA	61
EC3AE42M	48 VDC	12 VDC	250 mA	20 mA	102 mA	61
EC3AE43M	48 VDC	15 VDC	200 mA	20 mA	102 mA	61
EC3AE44M	48 VDC	±12 VDC	±125 mA	20 mA	102 mA	61
EC3AE45M	48 VDC	±15 VDC	±100 mA	20 mA	102 mA	61

EC3A-E SERIES

3 WATT, 2:1 INPUT RANGE

Visit www.cincon.com for new releases and a wider selection of products

Features

- ◆ 3W Isolated Output
- ◆ DIP-24/SMD Package
- ◆ Efficiency to 87%
- ◆ 2 : 1 Input Range
- ◆ Regulated Outputs
- ◆ Pi Input Filter
- ◆ Continuous Short Circuit Protection
- ◆ Meet EMI EN55022 class A
- ◆ No Tantalum Capacitor inside
- ◆ Wide Operating Temperature Range
- ◆ UL60950-1 Approval

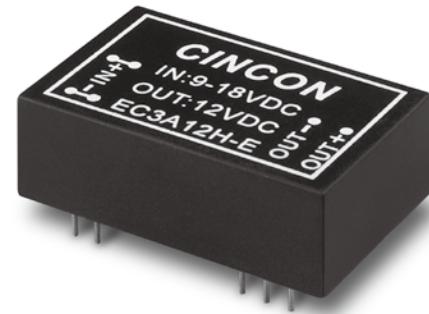

Mechanical Dimensions

NOTE: Pin Size is 0.02" Inch (0.5mm) DIA
All Dimensions in Inches (mm)
Tolerance Inches: X.XX±0.02, X.XXX±0.010
Millimeters: X.X±0.5, X.XX±0.25

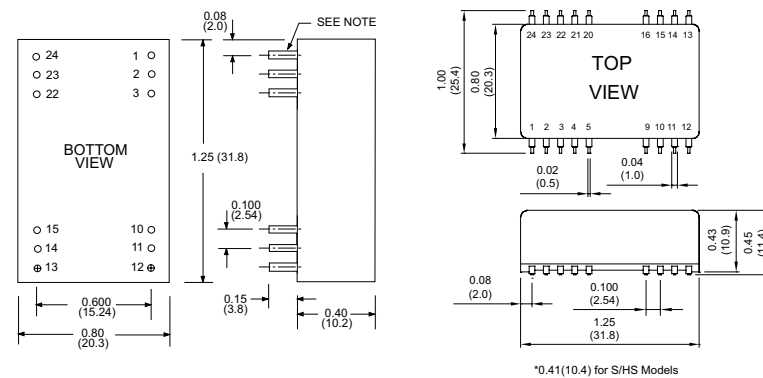

PIN CONNECTION									
500 VDC					1.5K & 3K VDC				
Pin	Single Output		Dual Output		Pin	Single Output		Dual Output	
	DIP	SMD	DIP	SMD		DIP	SMD	DIP	SMD
1,24	+V Input		+V Input		1,24	NP	NC	NP	NC
2,23	NC		-V Output		2,3	-V Input		-V Input	
3,22	NC		Common		4,5	NP	NC	NP	NC
4	NP	NC	NP	NC	9	NC		Common	
5	NP	NC	NP	NC	10,15	NC		NC	
9	NP	NC	NP	NC	11	NC		-V Output	
10,15	-V Output		Common		12,13	NP	NC	NP	NC
11,14	+V Output		+V Output		14	+V Output		+V Output	
12,13	-V Input		-V Input		16	-V Output		Common	
16	NP	NC	NP	NC	20,21	NP	NC	NP	NC
20,21	NP	NC	NP	NC	22,23	+V Input		+V Input	

* NP-NO PIN
* NC-NO CONNECTION WITH PIN

MODEL NUMBER	INPUT VOLTAGE	OUTPUT VOLTAGE	OUTPUT CURRENT	INPUT CURRENT		% EFF.	CAPACITOR LOAD MAX.
				NO LOAD	FULL LOAD		
EC3A01□-E	4.5-9 VDC	5 VDC	600 mA	15 mA	779 mA	77	2200µF
EC3A02□-E	4.5-9 VDC	12 VDC	250 mA	15 mA	750 mA	80	2200µF
EC3A03□-E	4.5-9 VDC	15 VDC	200 mA	15 mA	750 mA	80	2200µF
EC3A04□-E	4.5-9 VDC	±5 VDC	±300 mA	25 mA	779 mA	77	1000µF
EC3A05□-E	4.5-9 VDC	±12 VDC	±125 mA	25 mA	750 mA	80	1000µF
EC3A06□-E	4.5-9 VDC	±15 VDC	±100 mA	25 mA	750 mA	80	1000µF
EC3A07□-E	4.5-9 VDC	3.3 VDC	600 mA	15 mA	550 mA	72	2200µF
EC3A11□-E	9-18 VDC	5 VDC	600 mA	7.5 mA	309 mA	81	2200µF
EC3A12□-E	9-18 VDC	12 VDC	250 mA	10 mA	298 mA	84	2200µF
EC3A13□-E	9-18 VDC	15 VDC	200 mA	10 mA	294 mA	85	2200µF
EC3A14□-E	9-18 VDC	±5 VDC	±300 mA	15 mA	305 mA	82	1000µF
EC3A15□-E	9-18 VDC	±12 VDC	±125 mA	12 mA	298 mA	84	1000µF
EC3A16□-E	9-18 VDC	±15 VDC	±100 mA	15 mA	294 mA	85	1000µF
EC3A17□-E	9-18 VDC	3.3 VDC	600 mA	7.5 mA	212 mA	78	2200µF
EC3A21□-E	18-36 VDC	5 VDC	600 mA	7.5 mA	152 mA	82	2200µF
EC3A22□-E	18-36 VDC	12 VDC	250 mA	7.5 mA	145 mA	86	2200µF
EC3A23□-E	18-36 VDC	15 VDC	200 mA	7.5 mA	145 mA	86	2200µF
EC3A24□-E	18-36 VDC	±5 VDC	±300 mA	7.5 mA	152 mA	82	1000µF
EC3A25□-E	18-36 VDC	±12 VDC	±125 mA	10 mA	147 mA	85	1000µF
EC3A26□-E	18-36 VDC	±15 VDC	±100 mA	10 mA	145 mA	86	1000µF
EC3A27□-E	18-36 VDC	3.3 VDC	600 mA	5 mA	106 mA	78	2200µF
EC3A31□-E	36-72 VDC	5 VDC	600 mA	3 mA	74 mA	84	2200µF
EC3A32□-E	36-72 VDC	12 VDC	250 mA	3 mA	73 mA	86	2200µF
EC3A33□-E	36-72 VDC	15 VDC	200 mA	5 mA	73 mA	86	2200µF
EC3A34□-E	36-72 VDC	±5 VDC	±300 mA	5 mA	74 mA	85	1000µF
EC3A35□-E	36-72 VDC	±12 VDC	±125 mA	5 mA	72 mA	87	1000µF
EC3A36□-E	36-72 VDC	±15 VDC	±100 mA	5 mA	72 mA	87	1000µF
EC3A37□-E	36-72 VDC	3.3 VDC	600 mA	3 mA	52 mA	79	2200µF

NOTE: □= M, H, HM, S, MS, HS or HMS.

Derating Curve

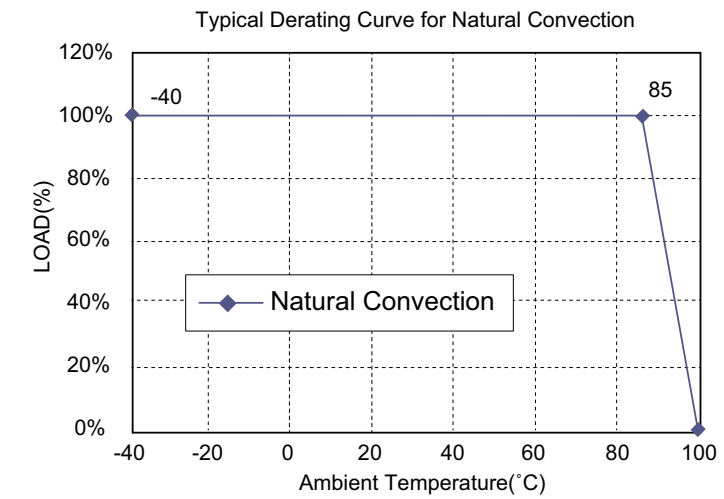

Specifications

All Specifications Typical At Nominal Line, Full Load, and 25°C Unless Otherwise Noted

INPUT SPECIFICATIONS

Input Voltage Range	5V	4.5-9V
	12V	9-18V
	24V	18-36V
	48V	36-72V
Input Surge Voltage (100ms max.)	5V	10Vdc max.
	12V	25Vdc max.
	24V	50Vdc max.
	48V	100Vdc max.
Under Voltage Lockout	5V	Power Up
		Power Down
	12V	Power Up
		Power Down
	24V	Power Up
		Power Down
	48V	Power Up
		Power Down
Input Filter		Pi Type

OUTPUT SPECIFICATIONS

Voltage Accuracy		±1.5% max.
Voltage Balance (Dual)		±1.0% max.
Temperature Coefficient		±0.05%/°C
Ripple & Noise, 20MHz BW (note 5)		3.3V/5V ...100mV pk-pk, max.
		12V/15V1% pk-pk max.
Short Circuit Protection		Continuous
Line Regulation	Single/Dual (note 1)	±0.5% max.
Load Regulation	Single (note 2)	±0.5% max.
	Dual (note 3)	±1.0% max.
Start up time		10 ms max.

GENERAL SPECIFICATIONS

Efficiency		See Table
Isolation Voltage:		
	500 VDC min.	Standard Models
	3K VDC min.	(Non-Conductive Black Plastic Only)
		Suffix "H" Models
		Suffix "HM" Models
Isolation Resistance		10 ⁹ ohm min.
Isolation Capacitance		250pF Typ.
Switching Frequency		100KHz min.
Operating Ambient Temperature Range		-40°C to +85°C
De-rating, Above 85°C		Linearly to Zero Power at 100°C
Case Temperature (note 4)		100°C max.
Cooling		Natural Convection
Storage Temperature Range		-40°C to +100°C
EMI		Conductive EMI Meet
		EN55022 Class A
		95% RH max. Non condensing
		2500Khrs typ.
Humidity		
MTBF	MIL-STD-217F	
Dimensions		DIP
		MS/HMS Models
		1.25 x 0.80 x 0.45 inches
		(31.8 x 20.3 x 11.4 mm)
		S/HS Models
		1.25 x 0.80 x 0.41 inches
		(31.8 x 20.3 x 10.4 mm)
Case Material:		
Standard Models		Non-Conductive Black Plastic
Suffix "M" Models		Black Coated Copper with
		Non-Conductive Base
Suffix "S" Models		SMD package
Weight		12.5 g

NOTE

1. Measured from high line to low line.
2. Measured from full load to 10% load.
3. Measured from full load to 1/4 load.
4. Maximum case temperature under any operating condition should not exceed 100°C.
5. The output noise is measured with 0.1µF MLCC across for SMD package.

EC3AB SERIES

3 WATT, 2:1 INPUT RANGE

Visit www.cincon.com for new releases and a wider selection of products

Features

- ◆ 3W Isolated Output
- ◆ DIP-24/SMD Package
- ◆ Efficiency to 80%
- ◆ Regulated Outputs
- ◆ Pi Input Filter
- ◆ Continuous Short Circuit Protection
- ◆ Meets EN55022 Class B, Conducted
- ◆ Remote ON/OFF (Option)

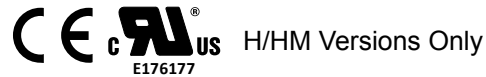
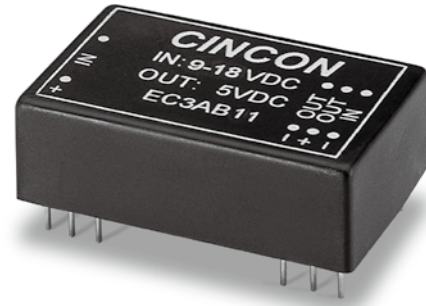

Mechanical Dimensions

NOTE: Pin Size is 0.02" Inch (0.5mm) DIA±0.05
All Dimensions in Inches (mm)
Tolerance Inches: X.XX=±0.02, X.XXX=±0.010
Millimeters: X.X=±0.5, X.XX=±0.25

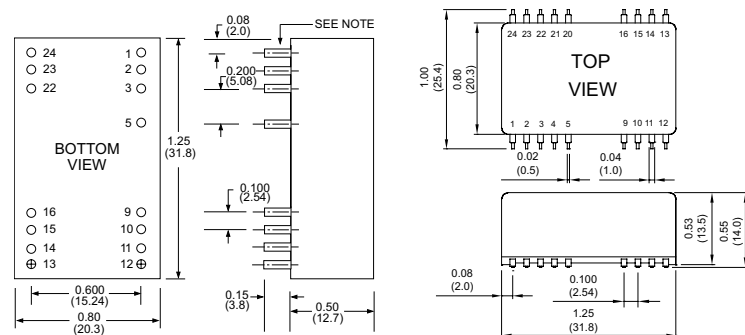

PIN CONNECTION									
500 VDC					1.5K & 3K VDC				
Pin	Single Output		Dual Output		Pin	Single Output		Dual Output	
	DIP	SMD	DIP	SMD		DIP	SMD	DIP	SMD
1,24	+V Input		+V Input		1,24	NP	NC	NP	NC
2,23	NC		-V Output		2,3	-V Input		-V Input	
3,22	NC		Common		4	NP	NC	NP	NC
4	NP	NC	NP	NC	5	NC		Common	
5	NP	NC	NP	NC	9	NC		NC	
9	NP	NC	NP	NC	10,15	NC		-V Output	
10,15	-V Output		Common		11	NP	NC	NP	NC
11,14	+V Output		+V Output		12,13	+V Output		+V Output	
12,13	-V Input		-V Input		14	-V Output		Common	
16	NP	NC	NP	NC	16	NP	NC	NP	NC
20	NP	NC	NP	NC	21,21	NP	NC	NP	NC
21	NP	NC	NP	NC	22,23	+V Input		+V Input	

* NP-NO PIN
* NC-NO CONNECTION WITH PIN

MODEL NUMBER	INPUT VOLTAGE	OUTPUT VOLTAGE	OUTPUT CURRENT	INPUT CURRENT		% EFF.
				NO LOAD	FULL LOAD	
EC3AB11	9-18 VDC	5 VDC	600 mA	7.5 mA	329 mA	76
EC3AB12	9-18 VDC	12 VDC	250 mA	7.5 mA	316 mA	79
EC3AB13	9-18 VDC	15 VDC	200 mA	7.5 mA	321 mA	78
EC3AB14	9-18 VDC	±5 VDC	±300 mA	12 mA	329 mA	76
EC3AB15	9-18 VDC	±12 VDC	±125 mA	12 mA	325 mA	77
EC3AB16	9-18 VDC	±15 VDC	±100 mA	12 mA	329 mA	76
EC3AB17	9-18 VDC	3.3 VDC	600 mA	7.5 mA	229 mA	72
EC3AB21	18-36 VDC	5 VDC	600 mA	5 mA	162 mA	77
EC3AB22	18-36 VDC	12 VDC	250 mA	5 mA	156 mA	80
EC3AB23	18-36 VDC	15 VDC	200 mA	5 mA	156 mA	80
EC3AB24	18-36 VDC	±5 VDC	±300 mA	7.5 mA	164 mA	76
EC3AB25	18-36 VDC	±12 VDC	±125 mA	7.5 mA	156 mA	80
EC3AB26	18-36 VDC	±15 VDC	±100 mA	7.5 mA	162 mA	77
EC3AB27	18-36 VDC	3.3 VDC	600 mA	5 mA	111 mA	74
EC3AB31	36-72 VDC	5 VDC	600 mA	2 mA	81 mA	77
EC3AB32	36-72 VDC	12 VDC	250 mA	2 mA	81 mA	77
EC3AB33	36-72 VDC	15 VDC	200 mA	2 mA	81 mA	77
EC3AB34	36-72 VDC	±5 VDC	±300 mA	3 mA	80 mA	78
EC3AB35	36-72 VDC	±12 VDC	±125 mA	3 mA	82 mA	76
EC3AB36	36-72 VDC	±15 VDC	±100 mA	3 mA	82 mA	76
EC3AB37	36-72 VDC	3.3 VDC	600 mA	3 mA	58 mA	71

Derating Curve

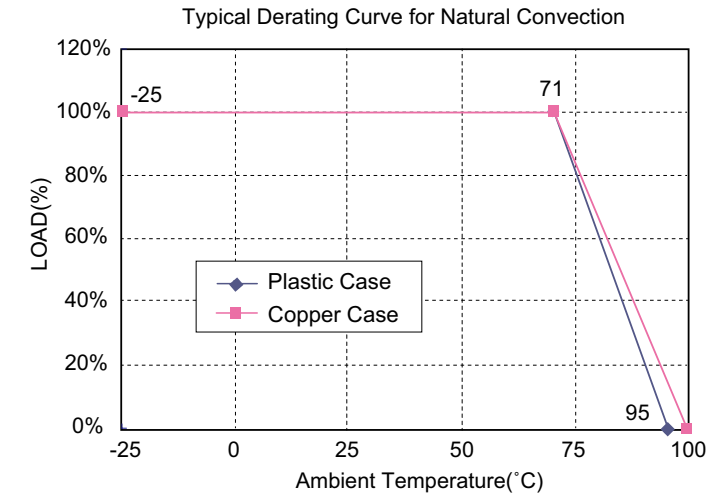

Specifications

All Specifications Typical At Nominal Line, Full Load, and 25°C Unless Otherwise Noted

INPUT SPECIFICATIONS

Input Voltage Range	12V 9-18V
	24V 18-36V
	48V 36-72V

Positive Logic Remote On/Off (see note 6)
Input Filter

Pi Type

OUTPUT SPECIFICATIONS

Voltage Accuracy	±2.0% max.
Voltage Balance (Dual)	±1.0% max.
Temperature Coefficient	±0.05%/°C
Ripple & Noise, 20MHz BW	3.3V/5V ...100mV pk-pk max. 12V/15V1% pk-pk max.

Short Circuit Protection
Line Regulation Single/Dual (note 1)
Load Regulation (note 2) Single
Dual (note 3)

±0.5% max.
±0.5% max.
±1.0% max.

GENERAL SPECIFICATIONS

Efficiency	See Table
Isolation Resistance	10 ⁹ ohm min.
Switching Frequency	100KHz min.
Operating Ambient Temperature Range	-25°C to +71°C
De-rating, Above 71°C (Plastic Case)	Linearly to Zero power at 95°C
De-rating, Above 71°C (Copper Case)	Linearly to Zero power at 100°C
Case Temperature (Plastic case note 8)	95°C max.
(Copper case note 8)	100°C max.
Cooling	Natural Convection
Storage Temperature Range	-40°C to +100°C
EMI/RFI	Conductive EMI Meet EN55022 Class B
Dimensions	DIP SMD
	1.25 x 0.80 x 0.50 inches (31.8 x 20.3 x 12.7 mm)
	1.25 x 0.80 x 0.55 inches (31.8 x 20.3 x 14.0 mm)

ISOLATION VOLTAGE

500 VDC min.	Standard Models
3K VDC min. (note 4)	Suffix "H" Models
1.5K VDC min.	Suffix "HM" Models

CASE MATERIAL

Standard Models	Non-Conductive Black Plastic
Suffix "M" Models	Black Coated Copper with Non-Conductive Base

NOTE

1. Measured from high line to low line.
2. Measured from full load to 10% load.
3. Measured from full load to 1/4 load.
4. Non-conductive black plastic only.
5. Suffix "T" to the model number with remote on/off for "H"/"HM" versions only.
6. Logic Compatibility CMOS or open collector TTL, ref. to -Vin
Module On >5.5VDC or open circuit
Module Off < 1.8Vdc.
Shutdown Idle 10mA
Control common referenced to input minus
7. Suffix "S" to the model number with SMD packages.
8. Maximum case temperature under any operating condition should not be exceeded 95°C (Plastic Case), 100°C (Copper Case).

EC3AW SERIES

3 WATT, 4:1 INPUT RANGE

Visit www.cincon.com for new releases and a wider selection of products

Features

- ◆ 3W Isolated Output
- ◆ DIP-24/SMD Package
- ◆ Efficiency to 77%
- ◆ 4 : 1 Input Range
- ◆ Regulated Outputs
- ◆ Pi Input Filter
- ◆ Continuous Short Circuit Protection

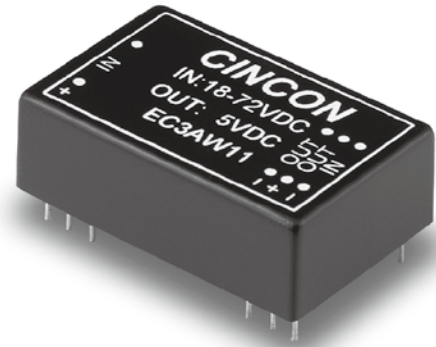

Mechanical Dimensions

NOTE: Pin Size is 0.02" Inch (0.5mm) DIA
All Dimensions in Inches (mm)
Tolerance Inches: X.XX±0.02, X.XXX±0.010
Millimeters: X.X±0.5, X.XX±0.25

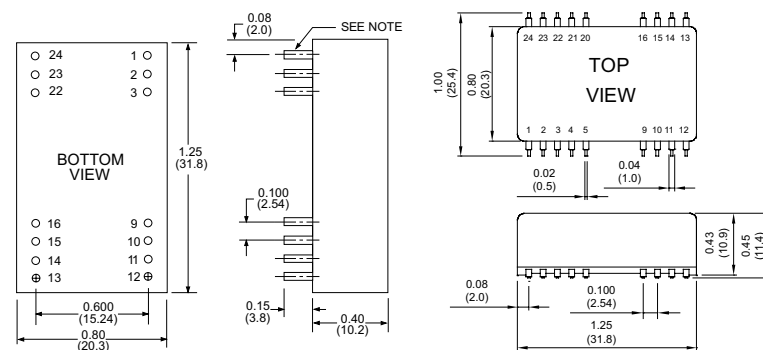

PIN CONNECTION									
500 VDC					1.5K & 3K VDC				
Pin	Single Output		Dual Output		Pin	Single Output		Dual Output	
	DIP	SMD	DIP	SMD		DIP	SMD	DIP	SMD
1,24	+V Input		+V Input		1,24	NP	NC	NP	NC
2,23	NC		-V Output		2,3	-V Input		-V Input	
3,22	NC		Common		4,5	NP	NC	NP	NC
4	NP	NC	NP	NC	9	NC		Common	
5	NP	NC	NP	NC	10,15	NC		NC	
9	NP	NC	NP	NC	11	NC		-V Output	
10,15	-V Output		Common		12,13	NP	NC	NP	NC
11,14	+V Output		+V Output		14	+V Output		+V Output	
12,13	-V Input		-V Input		16	-V Output		Common	
16	NP	NC	NP	NC	20,21	NP	NC	NP	NC
20,21	NP	NC	NP	NC	22,23	+V Input		+V Input	

* NP-NO PIN
* NC-NO CONNECTION WITH PIN

MODEL NUMBER	INPUT VOLTAGE	OUTPUT VOLTAGE	OUTPUT CURRENT	INPUT CURRENT		% EFF.
				NO LOAD	FULL LOAD	
EC3AW01	9-36 VDC	5 VDC	600 mA	15 mA	174 mA	72
EC3AW02	9-36 VDC	12 VDC	250 mA	15 mA	165 mA	76
EC3AW03	9-36 VDC	15 VDC	200 mA	15 mA	165 mA	76
EC3AW04	9-36 VDC	±5 VDC	±300 mA	25 mA	179 mA	70
EC3AW05	9-36 VDC	±12 VDC	±125 mA	25 mA	174 mA	72
EC3AW06	9-36 VDC	±15 VDC	±100 mA	25 mA	174 mA	72
EC3AW07	9-36 VDC	3.3 VDC	600 mA	15 mA	117 mA	70
EC3AW11	18-72 VDC	5 VDC	600 mA	7.5 mA	87 mA	72
EC3AW12	18-72 VDC	12 VDC	250 mA	7.5 mA	81 mA	77
EC3AW13	18-72 VDC	15 VDC	200 mA	7.5 mA	81 mA	77
EC3AW14	18-72 VDC	±5 VDC	±300 mA	12 mA	88 mA	71
EC3AW15	18-72 VDC	±12 VDC	±125 mA	12 mA	87 mA	72
EC3AW16	18-72 VDC	±15 VDC	±100 mA	12 mA	87 mA	72
EC3AW17	18-72 VDC	3.3 VDC	600 mA	7.5 mA	58 mA	70

Derating Curve

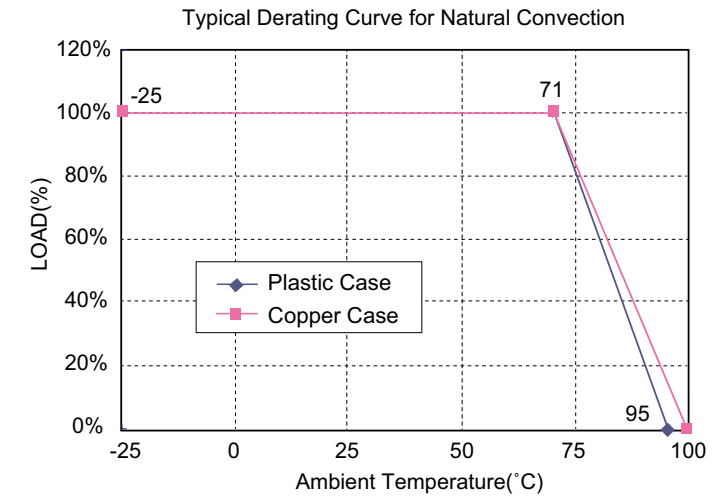

Specifications

All Specifications Typical At Nominal Line, Full Load, and 25°C Unless Otherwise Noted

INPUT SPECIFICATIONS

Input Voltage Range	24V 9-36V 48V 18-72V
Input Filter	Pi Type

OUTPUT SPECIFICATIONS

Voltage Accuracy	±2.0% max.
Voltage Balance (Dual)	±1.0% max.
Temperature Coefficient	±0.05%/°C
Ripple & Noise, 20MHz BW Single & ±5V Dual	100mV pk-pk max. 1% pk-pk max.
Short Circuit Protection	Continuous
Line Regulation Single/Dual (note 1)	±0.5% max.
Load Regulation Single (note 2) Dual (note 3)	±0.5% max. ±1.0% max.

ISOLATION VOLTAGE

500 VDC min.	Standard Models
3K VDC min. (note 4)	Suffix "H" Models
1.5K VDC min.	Suffix "HM" Models

CASE MATERIAL

Standard Models	Non-Conductive Black Plastic
Suffix "M" Models	Black Coated Copper with Non-conductive Base

NOTE

1. Measured from high line to low line.
2. Measured from full load to 10% load.
3. Measured from full load to 1/4 load.
4. Non-conductive black plastic only.
5. Suffix "S" to the model number with SMD packages.
6. Maximum case temperature under any operating condition should not be exceeded 95°C (Plastic Case), 100°C (Copper Case).

GENERAL SPECIFICATIONS

Efficiency	See Table
Isolation Resistance	10 ⁹ ohm min.
Switching Frequency	100KHz min.
Operating Ambient Temperature Range	-25°C to +71°C
De-rating, Above 71°C (Plastic Case)	Linearly to Zero power at 95°C
De-rating, Above 71°C (Copper Case)	Linearly to Zero power at 100°C
Case Temperature (Plastic case note 6) (Copper case note 6)	95°C max. 100°C max.
Cooling	Natural Convection
Storage Temperature Range	-40°C to +100°C
Dimension	DIP: 1.25 x 0.80 x 0.40 inches (31.8 x 20.3 x 10.2 mm) SMD: 1.25 x 0.80 x 0.45 inches (31.8 x 20.3 x 11.4 mm)
Weight	12.5 g

EC4A SERIES

5-6 WATT, 2:1 INPUT RANGE

Visit www.cincon.com for new releases and a wider selection of products

Features

- ◆ 5-6W Isolated Output
- ◆ DIP-24/SMD Package
- ◆ Efficiency to 84%
- ◆ 2 : 1 Input Range
- ◆ Regulated Outputs
- ◆ Pi Input Filter
- ◆ Continuous Short Circuit Protection
- ◆ UL60950-1 Approval for H/HM Versions only

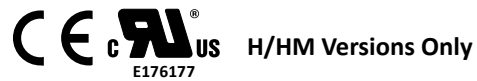
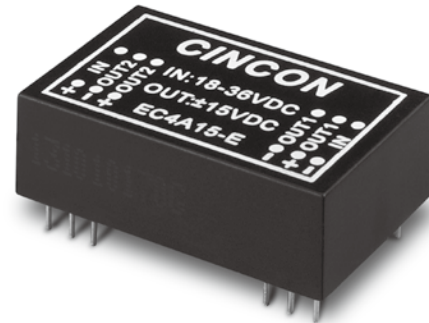

Mechanical Dimensions

NOTE: Pin Size is 0.02" Inch (0.5mm) DIA
All Dimensions in Inches (mm)
Tolerance Inches: X.XX=±0.02, X.XXX=±0.010
Millimeters: X.X=±0.5, X.XX=±0.25

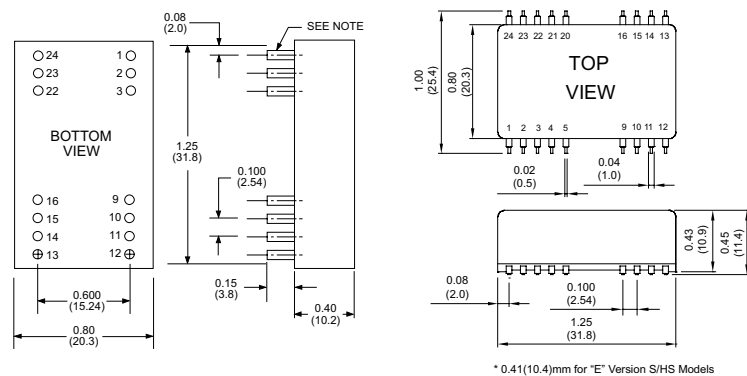

PIN CONNECTION									
500 VDC					1.5K & 3K VDC				
Pin	Single Output		Dual Output		Pin	Single Output		Dual Output	
	DIP	SMD	DIP	SMD		DIP	SMD	DIP	SMD
1,24	+V Input		+V Input		1,24	NP	NC	NP	NC
2,23	NC		-V Output		2,3	-V Input		-V Input	
3,22	NC		Common		4,5	NP	NC	NP	NC
4	NP	NC	NP	NC	9	NC		Common	
5	NP	NC	NP	NC	10,15	NC		NC	
9	NP	NC	NP	NC	11	NC		-V Output	
10,15	-V Output		Common		12,13	NP	NC	NP	NC
11,14	+V Output		+V Output		14	+V Output		+V Output	
12,13	-V Input		-V Input		16	-V Output		Common	
16	NP	NC	NP	NC	20,21	NP	NC	NP	NC
20,21	NP	NC	NP	NC	22,23	+V Input		+V Input	

* NP-NO PIN
* NC-NO CONNECTION WITH PIN

MODEL NUMBER	INPUT VOLTAGE	OUTPUT VOLTAGE	OUTPUT CURRENT	INPUT CURRENT		% EFF.	CAPACITOR LOAD MAX.
				NO LOAD	FULL LOAD		
EC4A01	9-18 VDC	5 VDC	1000 mA	7.5 mA	541 mA	77	4700µF
EC4A02	9-18 VDC	12 VDC	470 mA	7.5 mA	573 mA	82	4700µF
EC4A03	9-18 VDC	15 VDC	400 mA	7.5 mA	625 mA	80	4700µF
EC4A04	9-18 VDC	±12 VDC	±230 mA	12 mA	554 mA	83	2200µF
EC4A05	9-18 VDC	±15 VDC	±190 mA	12 mA	556 mA	81	2200µF
EC4A06	9-18 VDC	±5 VDC	±500 mA	12 mA	541 mA	77	2200µF
EC4A07	9-18 VDC	3.3 VDC	1000 mA	7.5 mA	382 mA	72	4700µF
EC4A11	18-36 VDC	5 VDC	1000 mA	5 mA	260 mA	80	4700µF
EC4A12	18-36 VDC	12 VDC	470 mA	5 mA	280 mA	84	4700µF
EC4A13	18-36 VDC	15 VDC	400 mA	5 mA	298 mA	84	4700µF
EC4A14	18-36 VDC	±12 VDC	±230 mA	7.5 mA	280 mA	82	2200µF
EC4A15	18-36 VDC	±15 VDC	±190 mA	7.5 mA	293 mA	81	2200µF
EC4A16	18-36 VDC	±5 VDC	±500 mA	7.5 mA	260 mA	80	2200µF
EC4A17	18-36 VDC	3.3 VDC	1000 mA	5 mA	186 mA	74	4700µF
EC4A21	36-72 VDC	5 VDC	1000 mA	2 mA	132 mA	79	4700µF
EC4A22	36-72 VDC	12 VDC	470 mA	2 mA	142 mA	83	4700µF
EC4A23	36-72 VDC	15 VDC	400 mA	2 mA	154 mA	81	4700µF
EC4A24	36-72 VDC	±12 VDC	±230 mA	3 mA	142 mA	81	2200µF
EC4A25	36-72 VDC	±15 VDC	±190 mA	3 mA	147 mA	81	2200µF
EC4A26	36-72 VDC	±5 VDC	±500 mA	3 mA	130 mA	80	2200µF
EC4A27	36-72 VDC	3.3 VDC	1000 mA	2 mA	93 mA	74	4700µF

Derating Curve

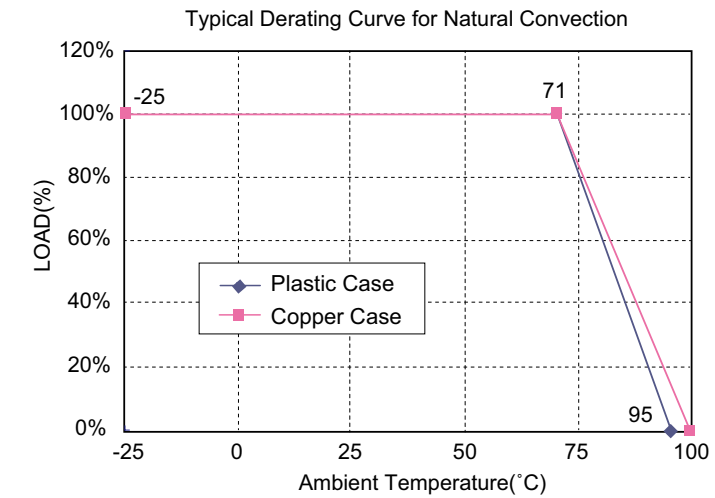

Specifications

All Specifications Typical At Nominal Line, Full Load, and 25°C Unless Otherwise Noted

INPUT SPECIFICATIONS

Input Voltage Range	12V 9-18V 24V 18-36V 48V 36-72V
Input Surge Voltage (100ms max.)	12V 25Vdc max. 24V 50Vdc max. 48V 100Vdc max.
Input Filter	Pi Type

OUTPUT SPECIFICATIONS

Voltage Accuracy	±2.0% max.
Voltage Balance (Dual)	±1.0% max.
Temperature Coefficient	±0.05%/°C
Ripple & Noise, 20MHz BW	3.3V/5V.....100mV pk-pk, max 12V/15V.....1% pk-pk max.
Short Circuit Protection	Continuous
Line Regulation	Single/Dual (note 1) ±0.5% max.
Load Regulation	Single (note 2) Dual (note 3) ±0.5% max. ±1.0% max.

NOTE

1. Measured from high line to low line.
2. Measured from full load to 10% load.
3. Measured from full load to 1/4 load.
4. Maximum case temperature under any operating condition should not be exceed 95°C (Plastic Case), 100°C (Copper Case).

GENERAL SPECIFICATIONS

Efficiency	See Table
Isolation Voltage:	500 VDC min. 3K VDC min. (Non-Conductive Black Plastic Only)
Isolation Resistance	1.5K VDC min.
Switching Frequency	100KHz min.
Operating Ambient Temperature Range	-25°C to +71°C
Power de-rating Curve	see Figure1
Case Temperature (note 4)	Plastic/Copper case. 95°C/100°C max.
Cooling	Natural Convection
Storage Temperature Range	-40°C to +100°C
Humidity	95% RH max. Non condensing
MTBF.....MIL-STD-217F	2000Khrs typ.
Dimensions	DIP 1.25 x 0.80 x 0.40 inches (31.8 x 20.3 x 10.2 mm)
	SMD 1.25 x 0.80 x 0.45 inches (31.8 x 20.3 x 11.4 mm)
Case Material:	
Standard Models	Non-Conductive Black Plastic
Suffix "M" Models	Black Coated Copper with Non-conductive Base
Suffix "S" Models	SMD package
Weight	12.5 g

EC4A-E SERIES

5-6 WATT, 2:1 INPUT RANGE

Visit www.cincon.com for new releases and a wider selection of products

Features

- ◆ 5-6W Isolated Output
- ◆ DIP-24/SMD Package
- ◆ Efficiency to 87%
- ◆ 2 : 1 Input Range
- ◆ Regulated Outputs
- ◆ Pi Input Filter
- ◆ Continuous Short Circuit Protection
- ◆ Meet EMI EN55022 class A
- ◆ No Tantalum Capacitor inside
- ◆ Wide Operating Temperature Range
- ◆ UL60950-1 Approval

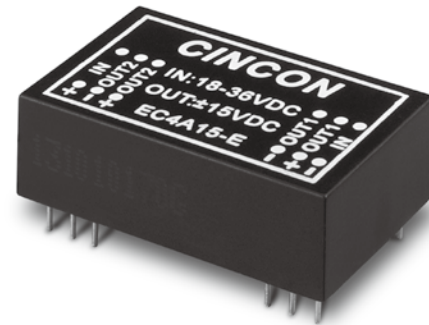

Mechanical Dimensions

NOTE: Pin Size is 0.02" Inch (0.5mm) DIA
All Dimensions in Inches (mm)
Tolerance Inches: X.XX±0.02, X.XXX±0.010
Millimeters: X.X±0.5, X.XX±0.25

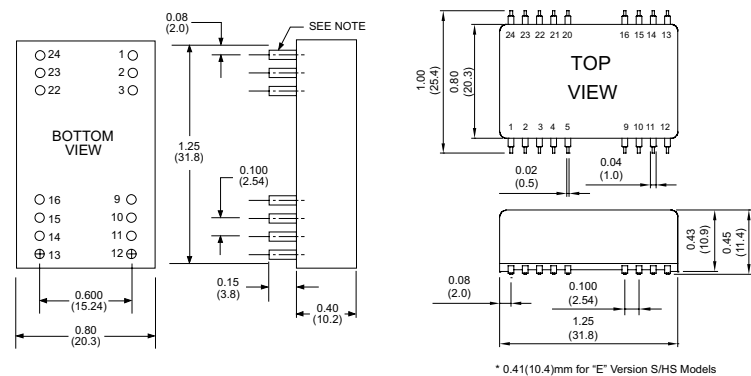

PIN CONNECTION									
Pin	500 VDC				1.5K & 3K VDC				
	Single Output		Dual Output		Single Output		Dual Output		
	DIP	SMD	DIP	SMD	DIP	SMD	DIP	SMD	
1,24	+V Input	+V Input	1,24	NP	NC	NP	NC		
2,23	NC	-V Output	2,3	-V Input	-V Input				
3,22	NC	Common	4,5	NP	NC	NP	NC		
4	NP	NC	NP	NC	9	NC	Common		
5	NP	NC	NP	NC	10,15	NC	NC		
9	NP	NC	NP	NC	11	NC	-V Output		
10,15	-V Output	Common	12,13	NP	NC	NP	NC		
11,14	+V Output	+V Output	14	+V Output	+V Output				
12,13	-V Input	-V Input	16	-V Output	Common				
16	NP	NC	NP	NC	20,21	NP	NC		
20,21	NP	NC	NP	NC	22,23	+V Input	+V Input		

* NP-NO PIN
* NC-NO CONNECTION WITH PIN

MODEL NUMBER	INPUT VOLTAGE	OUTPUT VOLTAGE	OUTPUT CURRENT	INPUT CURRENT		% EFF.	CASE
				NO LOAD	FULL LOAD		
EC4A01□-E	9-18 VDC	5 VDC	1000 mA	7.5 mA	514 mA	81	4700µF
EC4A02□-E	9-18 VDC	12 VDC	500 mA	10 mA	595 mA	84	4700µF
EC4A03□-E	9-18 VDC	15 VDC	400 mA	15 mA	588 mA	85	4700µF
EC4A04□-E	9-18 VDC	±12 VDC	±250 mA	12 mA	588 mA	85	2200µF
EC4A05□-E	9-18 VDC	±15 VDC	±200 mA	18 mA	588 mA	85	2200µF
EC4A06□-E	9-18 VDC	±5 VDC	±500 mA	12 mA	514 mA	81	2200µF
EC4A07□-E	9-18 VDC	3.3 VDC	1200 mA	7.5 mA	429 mA	77	4700µF
EC4A11□-E	18-36 VDC	5 VDC	1000 mA	5 mA	251 mA	83	4700µF
EC4A12□-E	18-36 VDC	12 VDC	500 mA	8 mA	291 mA	86	4700µF
EC4A13□-E	18-36 VDC	15 VDC	400 mA	8 mA	287 mA	87	4700µF
EC4A14□-E	18-36 VDC	±12 VDC	±250 mA	8 mA	291 mA	86	2200µF
EC4A15□-E	18-36 VDC	±15 VDC	±200 mA	10 mA	287 mA	87	2200µF
EC4A16□-E	18-36 VDC	±5 VDC	±500 mA	8 mA	254 mA	82	2200µF
EC4A17□-E	18-36 VDC	3.3 VDC	1200 mA	5 mA	209 mA	79	4700µF
EC4A21□-E	36-72 VDC	5 VDC	1000 mA	3 mA	126 mA	83	4700µF
EC4A22□-E	36-72 VDC	12 VDC	500 mA	6 mA	144 mA	87	4700µF
EC4A23□-E	36-72 VDC	15 VDC	400 mA	6 mA	144 mA	87	4700µF
EC4A24□-E	36-72 VDC	±12 VDC	±250 mA	6 mA	144 mA	87	2200µF
EC4A25□-E	36-72 VDC	±15 VDC	±200 mA	6 mA	144 mA	87	2200µF
EC4A26□-E	36-72 VDC	±5 VDC	±500 mA	5 mA	126 mA	83	2200µF
EC4A27□-E	36-72 VDC	3.3 VDC	1200 mA	2 mA	104 mA	79	4700µF

NOTE: □= M, H, HM, S, MS, HS or HMS.

Derating Curve

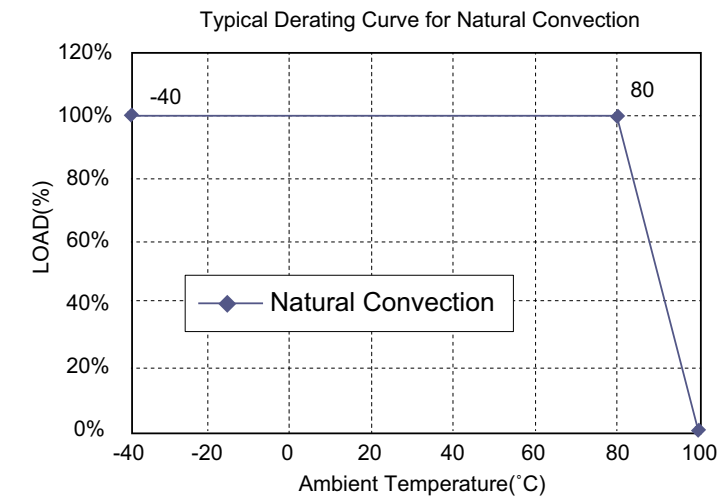

Specifications

All Specifications Typical At Nominal Line, Full Load, and 25°C Unless Otherwise Noted

INPUT SPECIFICATIONS

Input Voltage Range	12V 9-18V	24V 18-36V	48V 36-72V
Input Surge Voltage (100ms max.)	12V 25Vdc max.	24V 50Vdc max.	48V 100Vdc max.
Under Voltage Lockout	12V 8.8Vdc	24V 17Vdc	48V 34Vdc
	Power Up 8.8Vdc	Power Down 8Vdc	Power Up 16Vdc
			Power Down 16Vdc
			Power Up 34Vdc
			Power Down 31Vdc

OUTPUT SPECIFICATIONS

Voltage Accuracy	±1.5% max.
Voltage Balance (Dual)	±1.0% max.
Temperature Coefficient	±0.05%/°C
Ripple & Noise, 20MHz BW (note 5)	3.3V/5V 100mV pk-pk, max.
	12V/15V 1% pk-pk, max.
Short Circuit Protection	Continuous
Line Regulation	Single/Dual (note 1) ±0.5% max.
Load Regulation	Single (note 2) ±0.5% max.
	Dual (note 3) ±1.0% max.
Start up time	5 ms max.

NOTE

1. Measured from high line to low line.
2. Measured from full load to 10% load.
3. Measured from full load to 1/4 load.
4. Maximum case temperature under any operating condition should not exceed 100°C.
5. The output noise is measured with 0.1µF MLCC across for SMD package.

GENERAL SPECIFICATIONS

Efficiency	See Table
Isolation Voltage:	500 VDC min.
	3K VDC min.
	(Non-Conductive Black Plastic Only)
	1.5K VDC min.
Isolation Resistance	10 ⁹ ohm min.
Isolation Capacitance	250pF typ.
Switching Frequency	100KHz min.
Operating Temperature Range	-40°C to +85°C
De-rating, Above 80°C	Linearly to Zero Power at 100°C
Case Temperature	100°C max.
Coolin	Natural Convection
Storage Temperature Range	-40°C to +100°C
EMI	Conductive emi Meet EN55022 Class A
Humidity	95% RH max. Non condensing
MTBF.....MIL-STD-217F	1800Khrs typ.
Dimensions	DIP
	MS/HMS Models
	1.25 x 0.80 x 0.40 inches
	(31.8 x 20.3 x 10.2 mm)
	1.25 x 0.80 x 0.45 inches
	(31.8 x 20.3 x 11.4 mm)
	1.25 x 0.80 x 0.41 inches
	(31.8 x 20.3 x 10.4 mm)
Case Material:	
	Standard Models
	Suffix "M" Models
	Non-Conductive Black Plastic
	Black Coated Copper with
	Non-conductive Base
	SMD package
Weight	12.5 g

EC4AB SERIES

5-6 WATT, 2:1 INPUT RANGE

Visit www.cincon.com for new releases and a wider selection of products

Features

- ◆ 5-6W Isolated Output
- ◆ DIP-24/SMD Package
- ◆ Efficiency to 84%
- ◆ Regulated Outputs
- ◆ Pi Input Filter
- ◆ Continuous Short Circuit Protection
- ◆ Meets EN55022 Class B, Conducted
- ◆ Remote On/Off (Option)

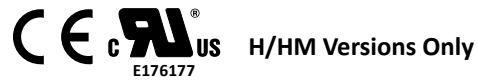
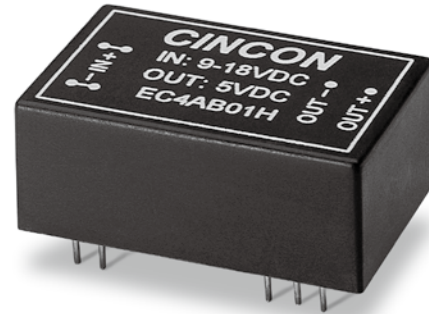

Mechanical Dimensions

NOTE: Pin Size is 0.02" Inch (0.5mm) DIA
All Dimensions in Inches (mm)
Tolerance Inches: X.XX±0.02, X.XXX±0.010
Millimeters: X.X±0.5, X.XX±0.25

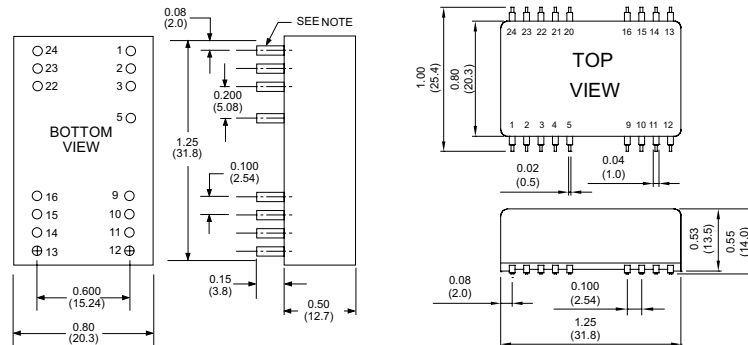

PIN CONNECTION									
500 VDC					1.5K & 3K VDC				
Single Output		Dual Output		Pin	Single Output		Dual Output		
DIP	SMD	DIP	SMD		DIP	SMD	DIP	SMD	
1,24	+V Input	+V Input	1,24	NP	NC	NP	NC		
2,23	NC	-V Output	2,3	-V Input	-V Input				
3,22	NC	Common	4	NP	NC	NP	NC		
4	NP	NC	NP	NC	5	NP/Remote On/Off	NC/Remote On/Off	NP/Remote On/Off	NC/Remote On/Off
5	NP	NC	NP	NC	9	NC	Common		
9	NP	NC	NP	NC	10,15	NC	NC		
10,15	-V Output	Common	11	NC	-V Output				
11,14	+V Output	+V Output	12,13	NP	NC	NP	NC		
12,13	-V Input	-V Input	14	+V Output	+V Output				
16	NP	NC	NP	NC	16	-V Output	Common		
20	NP	NC	NP	NC	20,21	NP	NC	NP	NC
21	NP	NC	NP	NC	22,23	+V Input	+V Input		

* NP-NO PIN
* NC-NO CONNECTION WITH PIN

MODEL NUMBER	INPUT VOLTAGE	OUTPUT VOLTAGE	OUTPUT CURRENT	INPUT CURRENT		% EFF.
				NO LOAD	FULL LOAD	
EC4AB01	9-18 VDC	5 VDC	1000 mA	7.5 mA	548 mA	76
EC4AB02	9-18 VDC	12 VDC	470 mA	7.5 mA	588 mA	80
EC4AB03	9-18 VDC	15 VDC	400 mA	7.5 mA	617 mA	81
EC4AB04	9-18 VDC	±12 VDC	±230 mA	12 mA	568 mA	81
EC4AB05	9-18 VDC	±15 VDC	±190 mA	12 mA	586 mA	81
EC4AB06	9-18 VDC	±5 VDC	±500 mA	12 mA	548 mA	76
EC4AB07	9-18 VDC	3.3 VDC	1000 mA	7.5 mA	382 mA	72
EC4AB11	18-36 VDC	5 VDC	1000 mA	5 mA	264 mA	79
EC4AB12	18-36 VDC	12 VDC	470 mA	5 mA	283 mA	83
EC4AB13	18-36 VDC	15 VDC	400 mA	5 mA	298 mA	84
EC4AB14	18-36 VDC	±12 VDC	±230 mA	7.5 mA	284 mA	81
EC4AB15	18-36 VDC	±15 VDC	±190 mA	7.5 mA	290 mA	82
EC4AB16	18-36 VDC	±5 VDC	±500 mA	7.5 mA	264 mA	79
EC4AB17	18-36 VDC	3.3 VDC	1000 mA	5 mA	188 mA	73
EC4AB21	36-72 VDC	5 VDC	1000 mA	2 mA	132 mA	79
EC4AB22	36-72 VDC	12 VDC	470 mA	2 mA	143 mA	82
EC4AB23	36-72 VDC	15 VDC	400 mA	2 mA	154 mA	81
EC4AB24	36-72 VDC	±12 VDC	±230 mA	3 mA	142 mA	81
EC4AB25	36-72 VDC	±15 VDC	±190 mA	3 mA	148 mA	80
EC4AB26	36-72 VDC	±5 VDC	±500 mA	3 mA	132 mA	79
EC4AB27	36-72 VDC	3.3 VDC	1000 mA	3 mA	94 mA	73

Derating Curve

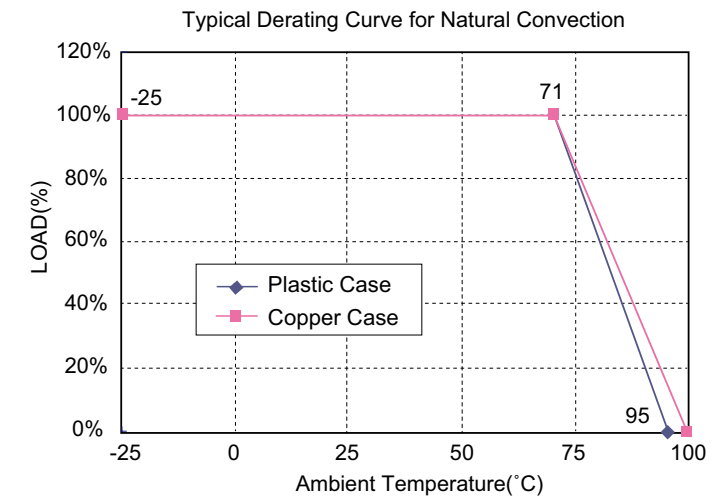

Specifications

All Specifications Typical At Nominal Line, Full Load, and 25°C Unless Otherwise Noted

INPUT SPECIFICATIONS

Input Voltage Range	12V 9-18V
	24V 18-36V
	48V 36-72V

Positive Logic Remote On/Off (see note 6)
Input Filter

Pi Type

OUTPUT SPECIFICATIONS

Voltage Accuracy	±2.0% max.
Voltage Balance (Dual)	±1.0% max.
Temperature Coefficient	±0.05%/°C
Ripple & Noise, 20MHz BW	3.3V/5V.....100mV pk-pk max. 12V/15V.....1% pk-pk max.

Short Circuit Protection
Line Regulation Single/Dual (note 1)
Load Regulation (note 2) Single
Dual (note 3)

Continuous	±0.5% max.
±0.5% max.	±1.0% max.

GENERAL SPECIFICATIONS

Efficiency	See Table
Isolation Resistance	10 ⁹ ohm min.
Switching Frequency	100KHz min.
Operating Ambient Temperature Range	-25°C to +71°C
De-rating, Above 71°C (Plastic Case)	Linearly to Zero power at 95°C
De-rating, Above 71°C (Copper Case)	Linearly to Zero power at 100°C
Case Temperature (Plastic case note 8)	95°C max.
(Copper case note 8)	100°C max.
Cooling	Natural Convection
Storage Temperature Range	-40°C to +100°C
EMI/RFI	Conductive EMI Meet EN55022 Class B
Dimensions	DIP 1.25 x 0.80 x 0.50 inches (31.8 x 20.3 x 12.7 mm)
	SMD 1.25 x 0.80 x 0.55 inches (31.8 x 20.3 x 14.0 mm)
Weight	15 g

ISOLATION VOLTAGE

500 VDC min.	Standard Models
3K VDC min. (note 4)	Suffix "H" Models
1.5K VDC min.	Suffix "HM" Models

CASE MATERIAL

Standard Models	Non-Conductive Black Plastic
Suffix "M" Models	Black Coated Copper with Non-conductive Base

NOTE

1. Measured from high line to low line.
2. Measured from full load to 10% load.
3. Measured from full load to 1/4 load.
4. Non-conductive black plastic only.
5. Suffix "T" to the model number with remote on/off for "H"/"HM" versions only.
6. Logic Compatibility CMOS or open collector TTL, ref. to -Vin
Module On >5.5VDC or open circuit
Module Off < 1.8Vdc.
Shutdown Idle 10mA
Control Common referenced to input minus
7. Suffix "S" to the model number with SMD packages.
8. Maximum case temperature under any operating condition should not be exceeded 95°C (Plastic Case), 100°C (Copper Case).

EC4AW SERIES

3.3-6 WATT, 4:1 INPUT RANGE

Visit www.cincon.com for new releases and a wider selection of products

Features

- ◆ 3.3W-6W Isolated Output
- ◆ DIP-24/SMD Package
- ◆ Efficiency to 83%
- ◆ 4 : 1 Input Range
- ◆ Regulated Outputs
- ◆ Pi Input Filter
- ◆ Continuous Short Circuit Protection
- ◆ Without Tantalum Capacitor Inside

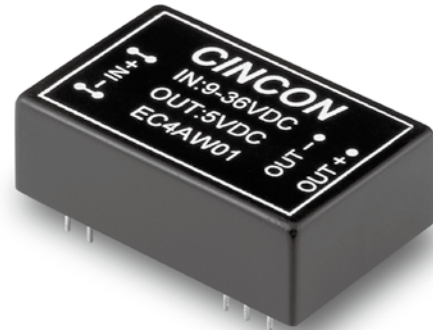

Mechanical Dimensions

NOTE: Pin Size is 0.02" Inch (0.5mm) DIA
All Dimensions in Inches (mm)
Tolerance Inches: X.XX±0.02, X.XXX±0.010
Millimeters: X.X±0.5, X.XX±0.25

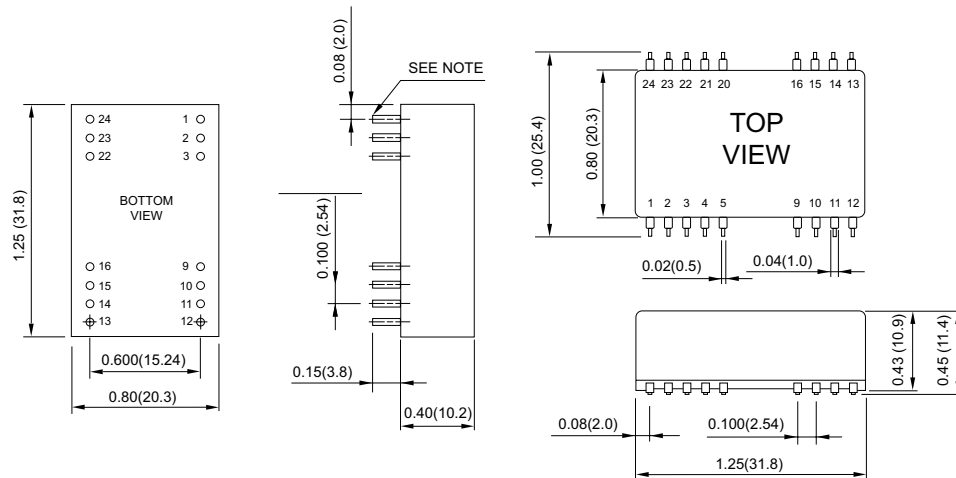

PIN CONNECTION				
Pin	Single Output		Dual Output	
	DIP	SMD	DIP	SMD
1,24	NP	NC	NP	NC
2,3	-V Output		-V Output	
4,5	NC		Common	
9	NP	NC	NP	NC
10,15	NP	NC	NP	NC
11	NP	NC	NP	NC
12,13	-V Output		Common	
14	+V Output		+V Output	
16	-V Input		-V Input	
20,21	NP	NC	NP	NC
22,23	NP	NC	NP	NC

* NP-NO PIN
* NC-NO CONNECTION WITH PIN

MODEL NUMBER	INPUT VOLTAGE	OUTPUT VOLTAGE	OUTPUT CURRENT	INPUT CURRENT		% EFF.	CAPACITOR LOAD MAX.
				NO LOAD	FULL LOAD		
EC4AW01	9-36 VDC	5 VDC	1000 mA	5 mA	254 mA	82	1000µF
EC4AW02	9-36 VDC	12 VDC	470 mA	5 mA	283 mA	83	470µF
EC4AW03	9-36 VDC	15 VDC	400 mA	5 mA	301 mA	83	400µF
EC4AW04	9-36 VDC	±12 VDC	±230 mA	7.5 mA	280 mA	82	230µF
EC4AW05	9-36 VDC	±15 VDC	±190 mA	7.5 mA	293 mA	81	190µF
EC4AW06	9-36 VDC	±5 VDC	±500 mA	5 mA	251 mA	83	500µF
EC4AW07	9-36 VDC	3.3 VDC	1000 mA	5 mA	176 mA	78	1000µF
EC4AW11	18-72 VDC	5 VDC	1000 mA	5 mA	132 mA	79	1000µF
EC4AW12	18-72 VDC	12 VDC	470 mA	5 mA	143 mA	82	470µF
EC4AW13	18-72 VDC	15 VDC	400 mA	5 mA	154 mA	81	400µF
EC4AW14	18-72 VDC	±12 VDC	±230 mA	7.5 mA	143 mA	80	230µF
EC4AW15	18-72 VDC	±15 VDC	±190 mA	7.5 mA	148 mA	80	190µF
EC4AW16	18-72 VDC	±5 VDC	±500 mA	5 mA	130 mA	80	500µF
EC4AW17	18-72 VDC	3.3 VDC	1000 mA	5 mA	93 mA	74	1000µF

Derating Curve

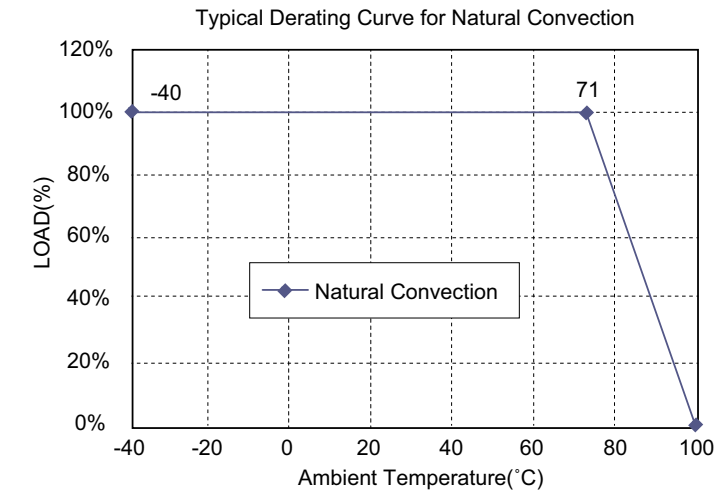

Specifications

All Specifications Typical At Nominal Line, Full Load, and 25°C Unless Otherwise Noted

INPUT SPECIFICATIONS

Input Voltage Range	24V 9-36V 48V 18-72V
Input Filter	Pi Type

OUTPUT SPECIFICATIONS

Voltage Accuracy	±2.0% max.
Voltage Balance (Dual)	±1.0% max.
Temperature Coefficient	±0.05%/°C
Ripple & Noise, 20MHz BW	100mV pk-pk max.
Short Circuit Protection	Continuous
Line Regulation Single/Dual (note 1)	±0.5% max.
Load Regulation Single (note 2)	±0.5% max.
Dual (note 3)	±1.0% max.
Start up time	30 ms typ.

ISOLATION VOLTAGE

1.5K VDC min.	Standard or Suffix "HM" Models
3K VDC min. (note 4)	Suffix "H" Models

CASE MATERIAL

Standard Models	Non-Conductive Black Plastic
Suffix "HM" Models (note 5)	Black Coated Copper with Non-conductive Base

NOTE

1. Measured from high line to low line.
1. Measured from high line to low line.
2. Measured from full load to 10% load.
3. Measured from full load to 1/4 load.
4. Non-conductive black plastic only.
5. Suffix "S" to the model number with SMD packages.
6. Maximum case temperature under any operating condition should not be exceeded 100°C.

GENERAL SPECIFICATIONS

Efficiency	See Table
Isolation Resistance	10 ⁹ ohm min.
Switching Frequency	200KHz min.
Operating Ambient Temperature Range	-40°C to +85°C
De-rating, Above 71°C	Linearly to Zero power at 100°C
Case Temperature	100°C max
Cooling	Natural Convection
Storage Temperature Range	-40°C to +100°C
Dimensions	DIP 1.25 x 0.80 x 0.40 inches (31.8 x 20.3 x 10.2 mm) SMD 1.25 x 0.80 x 0.45 inches (31.8 x 20.3 x 11.4 mm)
Weight	12.5 g

EC4AW-H6 SERIES

5-6 WATT, 6000 VDC ISOLATION

Visit www.cincon.com for new releases and a wider selection of products

Features

- ◆ 5-6W Isolated Output
- ◆ DIP-24 Package
- ◆ Regulated Outputs
- ◆ Efficiency to 85%
- ◆ Continuous Short Circuit Protection
- ◆ I/O Isolation Voltage 6000VDC
- ◆ Reinforced Insulation Rated For Working Voltage 300VAC
- ◆ 5µA Leakage Current
- ◆ EMI Meets EN55022 Class A
- ◆ Safety Meets UL60950-1 and UL60601-1
- ◆ CE Mark Meets 2004/108/EC

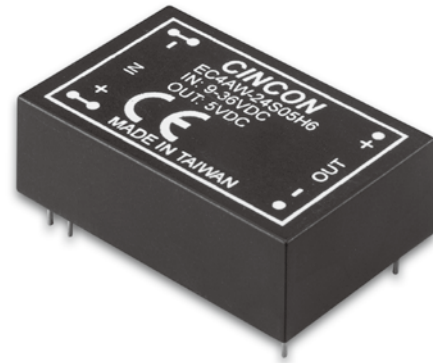

Mechanical Dimensions

NOTE: Pin Size is 0.02" Inch (0.5mm) DIA±0.05
All Dimensions in Inches (mm)
Tolerance Inches: X.XX±0.02, X.XXX±0.010
Millimeters: X.X±0.5, X.XX±0.25

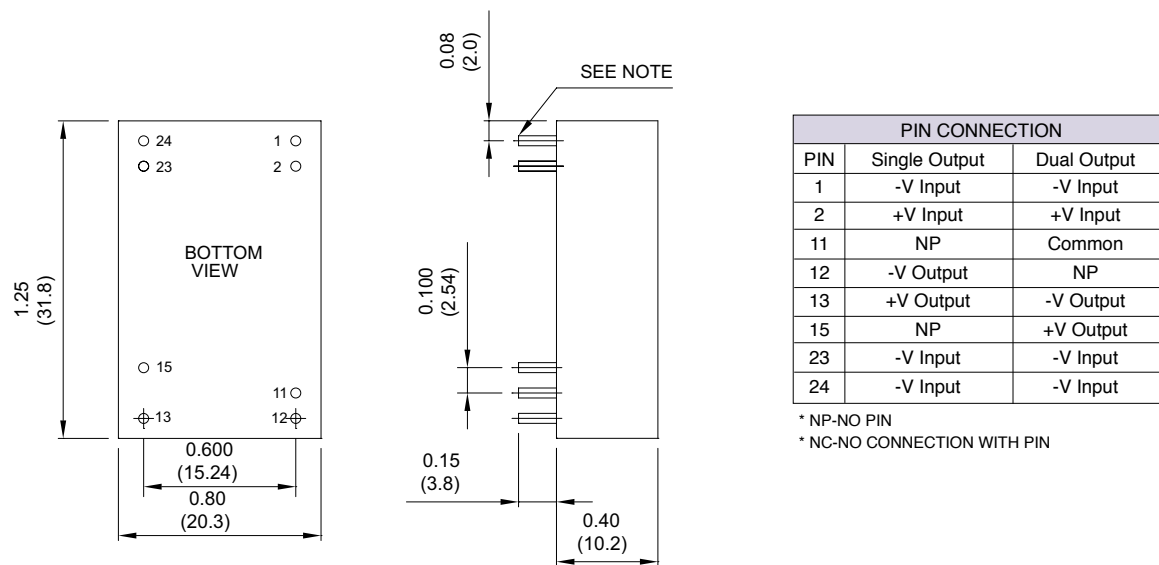

MODEL NUMBER	INPUT VOLTAGE	OUTPUT VOLTAGE	OUTPUT CURRENT		INPUT CURRENT		% EFF.	CAPACITOR LOAD MAX.
			MIN.	MAX.	NO LOAD	FULL LOAD		
EC4AW-24S05H6	9-36 VDC	5 VDC	100 mA	1000 mA	10 mA	260 mA	80	1000µF
EC4AW-24S12H6	9-36 VDC	12 VDC	50 mA	500 mA	10 mA	295 mA	85	500µF
EC4AW-24D12H6	9-36 VDC	±12 VDC	25 mA	±250 mA	15 mA	298 mA	84	250µF
EC4AW-24D15H6	9-36 VDC	±15 VDC	20 mA	±200 mA	15 mA	298 mA	84	200µF
EC4AW-48S05H6	18-72 VDC	5 VDC	100 mA	1000 mA	5 mA	130 mA	80	1000µF
EC4AW-48S12H6	18-72 VDC	12 VDC	50 mA	500 mA	5 mA	149 mA	84	500µF
EC4AW-48D12H6	18-72 VDC	±12 VDC	25 mA	±250 mA	8 mA	150 mA	83	250µF
EC4AW-48D15H6	18-72 VDC	±15 VDC	20 mA	±200 mA	8 mA	149 mA	84	200µF

Derating Curve

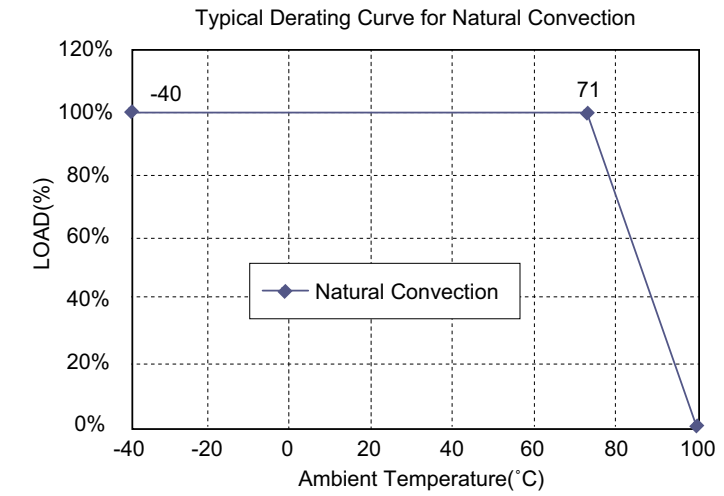

Specifications

All Specifications Typical At Nominal Line, Full Load, and 25°C Unless Otherwise Noted

INPUT SPECIFICATIONS

Input Voltage Range	24Vin 9-36V 48Vin 18-72V
Under Voltage Protection	24Vin power up 8.8V typ. 24Vin power down 8V typ. 48Vin power up 17V typ. 48Vin power down .. 16V typ.
Leakage Current	5uA max.
Input Filter	Pi Type
Input Surge (100ms max.)	24Vin 50V max. 48Vin 100V max.

OUTPUT SPECIFICATIONS

Voltage Accuracy	±1.5% max.
Voltage Balance (Dual)	±2.0% max.
Transient Response: 75% - 100% Step Load Change	
Error Band	±6% Vout nominal
Recovery Time	< 500µs
Ripple & Noise, 20MHz BW (with 0.1µF MLCC)	5V 100mV pk-pk max. 12V/15V 1% pk-pk max.
Temperature Coefficient	±0.05%/°C
Line Regulation (note 1)	±0.5% max.
Load Regulation	Single (note 2) ±0.5% max. Dual (note 3) ±1.0% max.
Cross Regulation(Dual output)	±5% max.
Load cross variation 25%/100%	Continuous
Output Short Circuit Protection	Continuous
Start up time	1.5ms typ.

GENERAL SPECIFICATIONS

Efficiency	See Table
Isolation Voltage	6000VDC min.
Isolation Resistance	10 ⁹ ohm min.
Isolation Capacitance	40pF typ.
Reinforced Insulation	Creepage Distances8mm min. Air Clearances 8mm min.
Switching Frequency	100KHz min.
Operating Ambient Temperature	-40°C to +71°C
De-rating, Above 71°C	Linearly to Zero power at 100°C
Case Temperature (note 4)	100°C max.
Storage Temperature	-40°C to +100°C
EMI	Conductive EMI Meet EN55022 Class A
Humidity	95% RH max. Non condensing
Dimensions	1.25 x 0.80 x 0.40 inches (31.8 x 20.3 x 10.2 mm)
Case Material	Non-Conductive Black Plastic

NOTE

1. Measured from high line to low line.
2. Measured from full load to 10% load.
3. Measured from full load to 25% load.
4. Maximum case temperature under any operating condition should not be exceeded 100°C.

EC5A SERIES

6-24 WATT, NON-ISOLATION

Visit www.cincon.com for new releases and a wider selection of products

Features

- ◆ 6-24W Non-Isolated Output
- ◆ DIP-24/SMD Package
- ◆ Efficiency to 94%
- ◆ Regulated Outputs
- ◆ Input LC Filter



Mechanical Dimensions

NOTE: Pin Size is 0.02" Inch (0.5mm) DIA
All Dimensions in Inches (mm)
Tolerance Inches: X.XX±0.02, X.XXX±0.010
Millimeters: X.X±0.5, X.XX±0.25

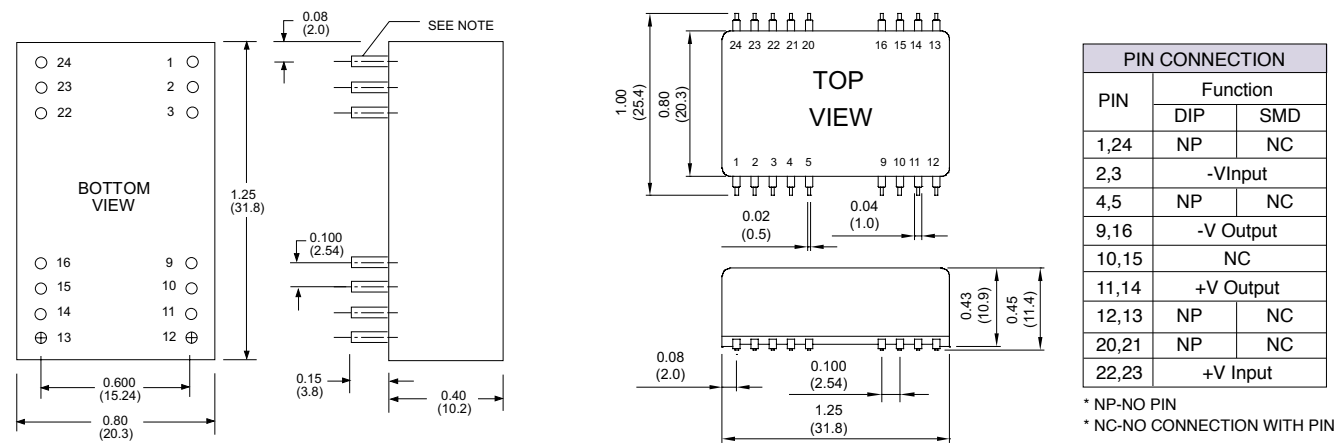

Derating Curve

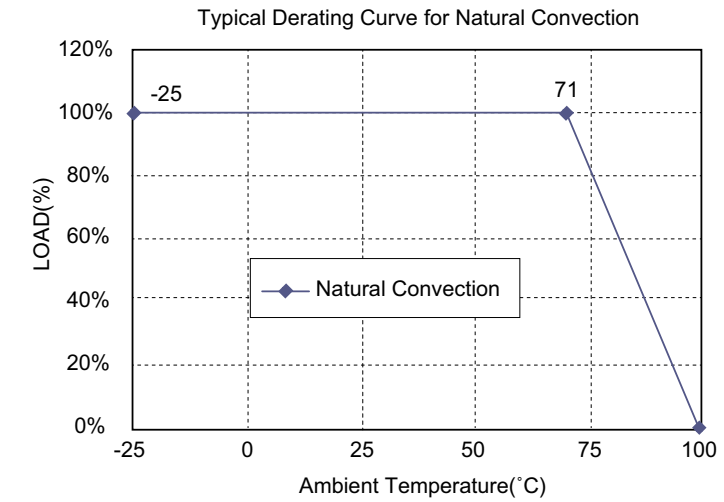

Specifications

All Specifications Typical At Nominal Line, Full Load, and 25°C Unless Otherwise Noted

INPUT SPECIFICATIONS

Input Voltage Range	5.0V 4.7-6V
	12V 9-32V
	24V 16-32V
	24V 19-32V
Input Filter	LC Type

OUTPUT SPECIFICATIONS

Voltage Accuracy	±2.0% max.
Temperature Coefficient	±0.05%/°C
Ripple & Noise, 20MHz BW	3.3V/5V.....100mV pk-pk max.
	12V/15V.....1% pk-pk max.
Over Current Protection	120~ 60%
Line Regulation (note 1)	±0.5% max.
Load Regulation (note 2)	±0.5% max.

GENERAL SPECIFICATIONS

Efficiency	See Table
Switching Frequency	150KHz typ.
Isolation Voltage (Input/Output)	Non-Isolation
Operating Ambient Temperature Range	-25°C to +71°C
De-rating, Above 71°C	Linearly to Zero power at 100°C
Case Temperature (note 4)	100°C max.
Cooling	Natural Convection
Storage Temperature Range	-40°C to +100°C
Dimensions	DIP
	1.25 x 0.80 x 0.40 inches
	(31.8 x 20.3 x 10.2 mm)
	SMD
	1.25 x 0.80 x 0.45 inches
	(31.8 x 20.3 x 11.4 mm)
Weight	17.8 g
Case Material	Black Coated Copper with Non-conductive Base

NOTE

1. Measured from high line to low line.
2. Measured from full load to 10% load.
3. Suffix "S" to the model number with SMD packages.
4. Maximum case temperature under any operating condition should not be exceeded 100°C.

MODEL NUMBER	INPUT VOLTAGE	OUTPUT VOLTAGE	OUTPUT CURRENT	INPUT CURRENT		% EFF
				NO LOAD	FULL LOAD	
EC5A-05S33	4.7-6 VDC	3.3 VDC	2000 mA	15 mA	1553 mA	85
EC5A-12S33	9-32 VDC	3.3 VDC	2000 mA	15 mA	655 mA	84
EC5A-12S05	9-32 VDC	5 VDC	2000 mA	15 mA	947 mA	88
EC5A-12S12	9-32 VDC	12 VDC	830 mA	15 mA	954 mA	87
EC5A-12S15	9-32 VDC	15 VDC	666 mA	15 mA	957 mA	87
EC5A-24S12	16-32 VDC	12 VDC	1600 mA	15 mA	860 mA	93
EC5A-24S15	19-32 VDC	15 VDC	1600 mA	15 mA	1064 mA	94

EC6A SERIES

7.5 WATT, 2:1 INPUT RANGE

Visit www.cincon.com for new releases and a wider selection of products

Features

- ◆ 7.5W Isolated Output
- ◆ DIP-24/SMD Package
- ◆ Efficiency to 87%
- ◆ 2 : 1 Input Range
- ◆ Regulated Outputs
- ◆ Pi Input Filter
- ◆ Continuous Short Circuit Protection
- ◆ CE Mark Meets 2004/108/EC
- ◆ UL60950-1 Approval
- ◆ Without Tantalum Capacitor Inside

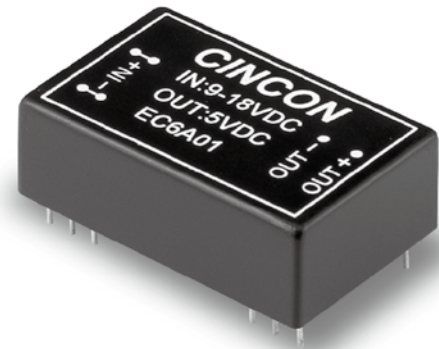

Mechanical Dimensions

NOTE: Pin Size is 0.02" Inch (0.5mm) DIA
All Dimensions in Inches (mm)
Tolerance Inches: X.XX±0.02, X.XXX±0.010
Millimeters: X.X±0.5, X.XX±0.25

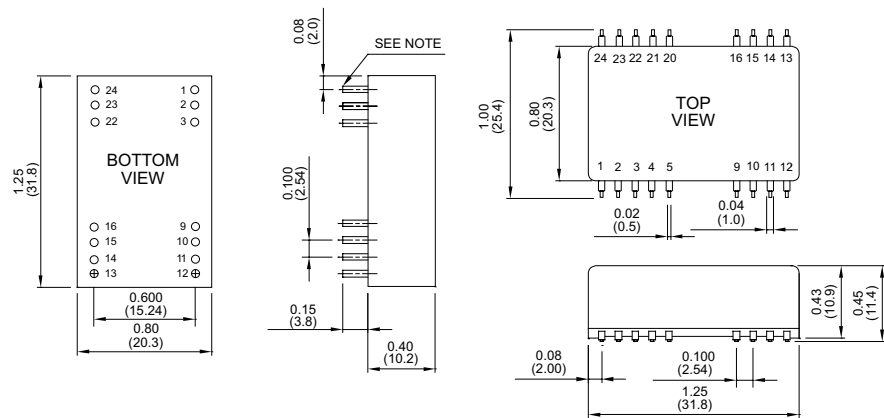

Pin	PIN CONNECTION			
	Single Output		Dual Output	
	DIP	SMD	DIP	SMD
1,24	NP	NC	NP	NC
2,3	-V Output		-V Output	
4,5	NP	NC	NP	NC
9	NC		Common	
10,15	NC		NC	
11	NC		-V Output	
12,13	NP	NC	NP	NC
14	+V Output		+V Output	
16	-V Output		Common	
20,21	NP	NC	NP	NC
22,23	+V Input		+V Input	

* NP-NO PIN
* NC-NO CONNECTION WITH PIN

MODEL NUMBER	INPUT VOLTAGE	OUTPUT VOLTAGE	OUTPUT CURRENT		INPUT CURRENT		% EFF.	CAPACITOR LOAD MAX.
			MIN.	MAX.	NO LOAD	FULL LOAD		
EC6A01	9-18 VDC	5 VDC	0 mA	1500 mA	25 mA	781 mA	80	4700µF
EC6A02	9-18 VDC	12 VDC	0 mA	625 mA	25 mA	753 mA	83	4700µF
EC6A03	9-18 VDC	15 VDC	0 mA	500 mA	25 mA	744 mA	84	4700µF
EC6A04	9-18 VDC	±5 VDC	0 mA	±750 mA	30 mA	772 mA	81	2200µF
EC6A05	9-18 VDC	±12 VDC	0 mA	±310 mA	30 mA	753 mA	83	2200µF
EC6A06	9-18 VDC	±15 VDC	0 mA	±250 mA	30 mA	753 mA	83	2200µF
EC6A07	9-18 VDC	3.3 VDC	0 mA	1500 mA	25 mA	529 mA	78	4700µF
EC6A11	18-36 VDC	5 VDC	0 mA	1500 mA	20 mA	377 mA	83	4700µF
EC6A12	18-36 VDC	12 VDC	0 mA	625 mA	20 mA	359 mA	87	4700µF
EC6A13	18-36 VDC	15 VDC	0 mA	500 mA	20 mA	359 mA	87	4700µF
EC6A14	18-36 VDC	±5 VDC	0 mA	±750 mA	25 mA	372 mA	84	2200µF
EC6A15	18-36 VDC	±12 VDC	0 mA	±310 mA	25 mA	356 mA	87	2200µF
EC6A16	18-36 VDC	±15 VDC	0 mA	±250 mA	25 mA	372 mA	84	2200µF
EC6A17	18-36 VDC	3.3 VDC	0 mA	1500 mA	20 mA	264 mA	78	4700µF
EC6A21	36-72 VDC	5 VDC	0 mA	1500 mA	10 mA	193 mA	81	4700µF
EC6A22	36-72 VDC	12 VDC	0 mA	625 mA	10 mA	184 mA	85	4700µF
EC6A23	36-72 VDC	15 VDC	0 mA	500 mA	10 mA	182 mA	86	4700µF
EC6A24	36-72 VDC	±5 VDC	0 mA	±750 mA	15 mA	191 mA	82	2200µF
EC6A25	36-72 VDC	±12 VDC	0 mA	±310 mA	15 mA	182 mA	85	2200µF
EC6A26	36-72 VDC	±15 VDC	0 mA	±250 mA	15 mA	184 mA	85	2200µF
EC6A27	36-72 VDC	3.3 VDC	0 mA	1500 mA	10 mA	136 mA	76	4700µF

Derating Curve

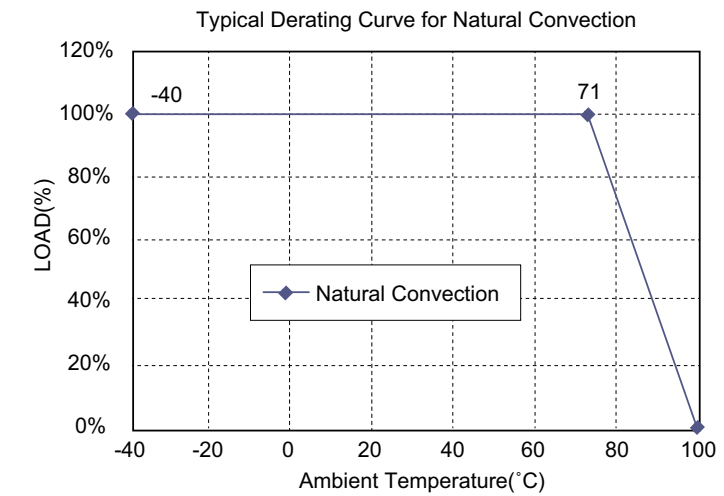

Specifications

All Specifications Typical At Nominal Line, Full Load, and 25°C Unless Otherwise Noted

INPUT SPECIFICATIONS

Input Voltage Range	12V 9-18V 24V 18-36V 48V 36-72V
Input Surge Voltage (100ms max.)	12V 20Vdc max. 24V 50Vdc max. 48V 100Vdc max.
Input Filter	Pi Type

OUTPUT SPECIFICATIONS

Voltage Accuracy	±2.0% max.
Voltage Balance (Dual)	±1.0% max.
Temperature Coefficient	±0.05%/°C
Ripple & Noise, 20MHz BW	100mV pk-pk max.
Short Circuit Protection	Continuous
Line Regulation Single/Dual (note 1)	±0.2% max.
Load Regulation Single (note 2)	±0.5% max.
	Dual (note 3)
Start up time	EC6A0XX 5ms typ. Other 20ms typ.

GENERAL SPECIFICATIONS

Efficiency	See Table
Isolation Resistance	10 ⁹ ohm min.
Isolation Capacitance	560pF typ.
Isolation Voltage	1500VDC min.
Switching Frequency	300KHz typ.
Operating Ambient Temperature Range	-40°C to +85°C
De-rating, Above 71°C	Linearly to Zero power at 100°C
Case Temperature (note 5)	100°C max.
Cooling	Natural Convection
Storage Temperature Range	-40°C to +100°C
Humidity	95% RH max. Non condensing
MTBF MIL-STD-217F, GB, 25°C, Full Load	1800Khrs typ.
Dimensions	DIP 1.25 x 0.80 x 0.40 inches (31.8 x 20.3 x 10.2 mm) SMD 1.25 x 0.80 x 0.45 inches (31.8 x 20.3 x 11.4 mm)
Weight	18.4g
Case Material	Black Coated Copper with Non-conductive Base

NOTE

1. Measured from high line to low line.
2. Measured from full load to 10% load.
3. Measured from full load to 1/4 load.
4. Suffix "S" to the model number with SMD packages.
5. Maximum case temperature under any operating condition should not be exceeded 100°C.

EC6AW SERIES

8 WATT, 4:1 INPUT RANGE

Visit www.cincon.com for new releases and a wider selection of products

Features

- ◆ 8W Isolated Output
- ◆ DIP-24/SMD Package
- ◆ Efficiency to 86%
- ◆ 4 : 1 Input Range
- ◆ Regulated Outputs
- ◆ Input Under-Voltage Protection
- ◆ Remote On/Off
- ◆ Continuous Short Circuit Protection
- ◆ Without Tantalum Capacitors Inside
- ◆ CE Mark Meets 2004/108/EC
- ◆ Safety Meets UL60950-1, EN60950-1, and IEC60950-1



Mechanical Dimensions

NOTE: Pin Size is 0.02" Inch (0.5mm) DIA
All Dimensions in Inches (mm)
Tolerance Inches: X.XX±0.02, X.XXX±0.010
Millimeters: X.X±0.5, X.XX±0.25

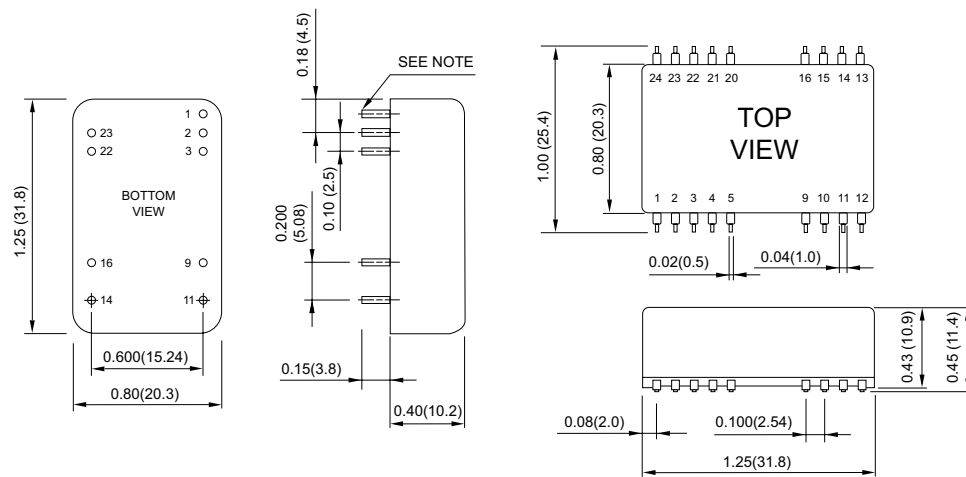

PIN CONNECTION				
Pin	Single Output		Dual Output	
	DIP	SMD	DIP	SMD
1,24	NP	NC	NP	NC
2,3	-V Output		-V Output	
4,5	NP	NC	NP	NC
9	NC		Common	
10,15	NC		NC	
11	NC		-V Output	
12,13	NP	NC	NP	NC
14	+V Output		+V Output	
16	-V Output		Common	
20,21	NP	NC	NP	NC
22,23	+V Input		+V Input	

* NP-NO PIN
* NC-NO CONNECTION WITH PIN

MODEL NUMBER	INPUT VOLTAGE	OUTPUT VOLTAGE	OUTPUT CURRENT		INPUT CURRENT		% EFF.	CAPACITOR LOAD MAX.
			MIN.	MAX.	NO LOAD	FULL LOAD		
EC6AW-24S33	9-36 VDC	3.3 VDC	0 mA	2000 mA	10 mA	344 mA	80	2000µF
EC6AW-24S05	9-36 VDC	5 VDC	0 mA	1600 mA	10 mA	406 mA	82	1600µF
EC6AW-24S12	9-36 VDC	12 VDC	0 mA	666 mA	10 mA	392 mA	85	666µF
EC6AW-24S15	9-36 VDC	15 VDC	0 mA	530 mA	10 mA	390 mA	85	530µF
EC6AW-24D05	9-36 VDC	±5 VDC	0 mA	±800 mA	10 mA	406 mA	82	800µF
EC6AW-24D12	9-36 VDC	±12 VDC	0 mA	±333 mA	10 mA	392 mA	85	333µF
EC6AW-24D15	9-36 VDC	±15 VDC	0 mA	±265 mA	10 mA	390 mA	85	265µF
EC6AW-48S33	18-75 VDC	3.3 VDC	0 mA	2000 mA	5 mA	172 mA	80	2000µF
EC6AW-48S05	18-75 VDC	5 VDC	0 mA	1600 mA	5 mA	201 mA	83	1600µF
EC6AW-48S12	18-75 VDC	12 VDC	0 mA	666 mA	5 mA	194 mA	86	666µF
EC6AW-48S15	18-75 VDC	15 VDC	0 mA	530 mA	5 mA	193 mA	86	530µF
EC6AW-48D05	18-75 VDC	±5 VDC	0 mA	800 mA	5 mA	201 mA	83	800µF
EC6AW-48D12	18-75 VDC	±12 VDC	0 mA	±333 mA	5 mA	194 mA	86	333µF
EC6AW-48D15	18-75 VDC	±15 VDC	0 mA	±265 mA	5 mA	193 mA	86	265µF

Derating Curve

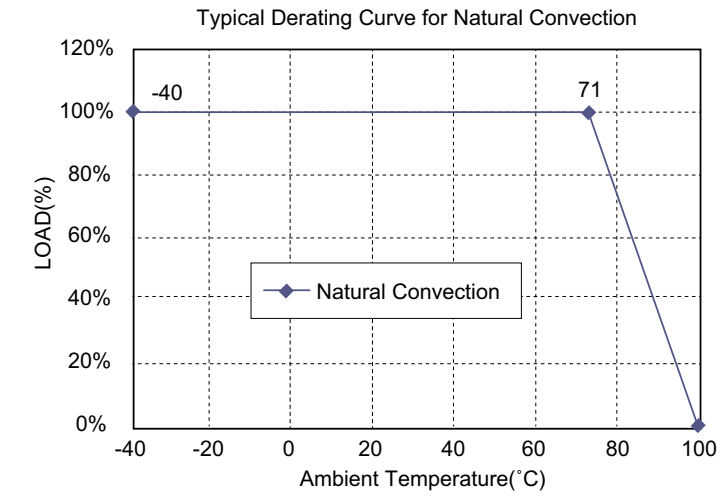

Specifications

All Specifications Typical At Nominal Line, Full Load, and 25°C Unless Otherwise Noted

INPUT SPECIFICATIONS

Input Voltage Range	24V 9-36V 48V 18-75V
Input Surge Voltage (100ms max.)	24V 50Vdc max. 48V 100Vdc max.
Under voltage lockout	24V 48V power up.....8.8V typ. power down.....8.0V typ. power up.....17V typ. power down.....16V typ.
Input Filter	PI Type
Positive Logic Remote on/off Control (note 3):	CMOS or Open Collector
Logic Compatibility	TTL, ref. to -Vin >+3.5V to 36VDC or Open Circuit <1.2VDC
Module On	
Module Off	

OUTPUT SPECIFICATIONS

Voltage Accuracy	±1.5% max.
Voltage Balance (Dual)	±1.0% max.
Transient Response: 75% - 100% Step Load Change	
Error Band	±5% Vout nominal,
Recovery Time	< 500µs
Ripple & Noise, 20MHz BW (with 0.1µF MLCC)	
Vo=3.3 & 5V	75mV pk-pk max.
Vo=12 & 15V	100mV pk-pk max.
Temperature Coefficient	±0.03%/°C max.
Short Circuit Protection	continuous
Line Regulation (note1)	Single/Dual ±0.5% max.
Load Regulation (note2)	Single ±0.5% max. Dual ±1.0% max.
Cross Regulation (Dual output)	±5% max.
Load cross variation 25%/100%	
Over Voltage Protection	Zener or TVS Clamp
Start up time	3.5ms typ.

GENERAL SPECIFICATIONS

Efficiency	See Table
Isolation Voltage	1500 VDC min.
Isolation Resistance	10 ⁹ ohms min.
Isolation Capacitance	1000pF typ.
Switching Frequency	100KHz min.
Operating Ambient Temperature Range	-40°C to +85°C
Derating, Above 71°C	Linearly to Zero Power at +100°C
Case Temperature (note 5)	100°C
Cooling	Natural Convection
Storage Temperature Range	-55°C to +125°C
Humidity	95% RH max. Non condensing
MTBF MIL-STD-217F, GB, 25°C, Full Load	
Single	1500Khrs typ.
Dual	1300Khrs typ.
Dimensions	DIP 1.25 x 0.80 x 0.40 inches (31.8 x 20.3 x 10.2 mm)
SMD	1.25 x 0.80 x 0.45 inches (31.8 x 20.3 x 11.4 mm)
Case Material	Black Coated Copper with Non-Conductive Base
Weight	18.4 g

NOTE

1. Measured from high line to low line.
2. Measured from full load to min. load.
3. Suffix "N" to the model number with negative logic remote On/Off
Module On < 1.2VDC
Module Off >+3.5VDC to 36VDC or open circuit
4. Suffix "S" to the model number with SMD package.
5. Maximum case temperature under any operating condition should not be exceeded 100°C.

EC7A SERIES

10 WATT, 2:1 INPUT RANGE

Visit www.cincon.com for new releases and a wider selection of products

Features

- ◆ 10W Isolated Output
- ◆ DIP-24 / SMD Package
- ◆ Very High Efficiency Up to 89%
- ◆ 2 : 1 Input Range
- ◆ Regulated Outputs
- ◆ PI Input Filter
- ◆ Continuous Short Circuit Protection
- ◆ No Tantalum Capacitor Inside
- ◆ CE Mark Meets 2004/108/EC
- ◆ UL60950-1 Approval

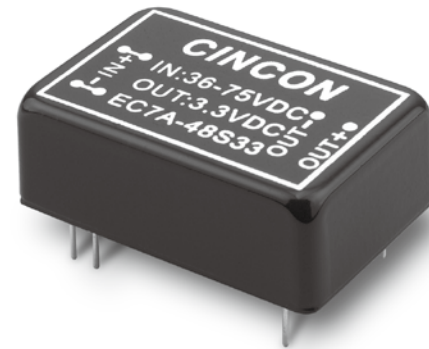

Mechanical Dimensions

NOTE: Pin Size is 0.02" Inch (0.5mm) DIA
All Dimensions in Inches (mm)
Tolerance Inches: X.XX±0.02, X.XXX±0.010
Millimeters: X.X±0.5, X.XX±0.25

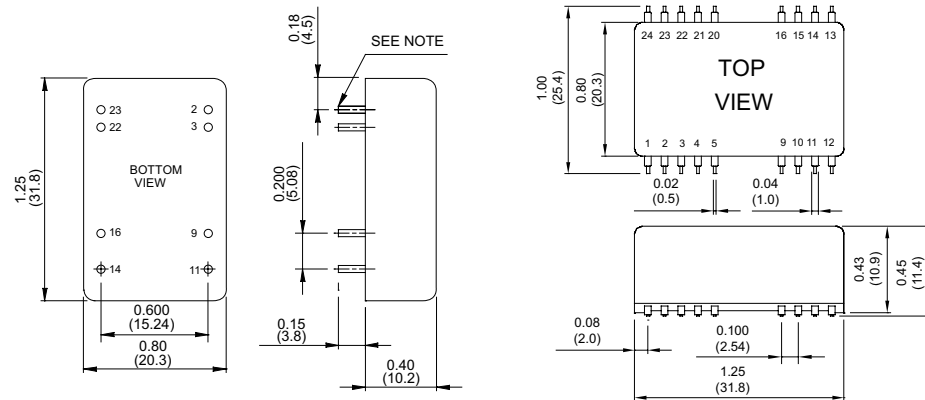

PIN CONNECTION				
Pin	Single Output		Dual Output	
	DIP	SMD	DIP	SMD
1,24	NP	NC	NP	NC
2,3	-V Input		-V Input	
4,5	NP	NC	NP	NC
9	NP	NC	Common	
10	NP	NC	NP	NC
11	NC		-V Output	
12	NP	NC	NP	NC
13	NP	+V Output	NP	NC
14	+V Output	+V Output		
15	NP	-V Output	NP	NC
16	-V Output		Common	
20,21	NP	NC	NP	NC
22,23	+V Input		-V Input	

* NP-NO PIN
* NC-NO CONNECTION WITH PIN

MODEL NUMBER	INPUT VOLTAGE	OUTPUT VOLTAGE	OUTPUT CURRENT		INPUT CURRENT		% EFF.	CAPACITOR LOAD MAX.
			MIN.	MAX.	NO LOAD	FULL LOAD		
EC7A-12S25	9-18 VDC	2.5 VDC	0 mA	3000 mA	40 mA	735 mA	85	3000µF
EC7A-12S33	9-18 VDC	3.3 VDC	0 mA	3000 mA	50 mA	971 mA	85	3000µF
EC7A-12S05	9-18 VDC	5 VDC	0 mA	2000 mA	60 mA	947 mA	88	2000µF
EC7A-12S12	9-18 VDC	12 VDC	0 mA	835 mA	40 mA	949 mA	88	835µF
EC7A-12S15	9-18 VDC	15 VDC	0 mA	666 mA	40 mA	946 mA	88	666µF
EC7A-12D12	9-18 VDC	±12 VDC	0 mA	±416 mA	30 mA	956 mA	87	416µF
EC7A-12D15	9-18 VDC	±15 VDC	0 mA	±333 mA	30 mA	968 mA	86	333µF
EC7A-24S25	18-36VDC	2.5 VDC	0 mA	3000 mA	30 mA	368 mA	85	3000µF
EC7A-24S33	18-36VDC	3.3 VDC	0 mA	3000 mA	30 mA	480 mA	86	3000µF
EC7A-24S05	18-36VDC	5 VDC	0 mA	2000 mA	30 mA	473 mA	88	2000µF
EC7A-24S12	18-36VDC	12 VDC	0 mA	835 mA	30 mA	469 mA	89	835µF
EC7A-24S15	18-36VDC	15 VDC	0 mA	666 mA	30 mA	473 mA	88	666µF
EC7A-24D12	18-36VDC	±12 VDC	0 mA	±416 mA	20 mA	467 mA	89	416µF
EC7A-24D15	18-36VDC	±15 VDC	0 mA	±333 mA	20 mA	478 mA	87	333µF
EC7A-48S25	36-75VDC	2.5 VDC	0 mA	3000 mA	15 mA	184 mA	85	3000µF
EC7A-48S33	36-75VDC	3.3 VDC	0 mA	3000 mA	15 mA	243 mA	85	3000µF
EC7A-48S05	36-75VDC	5 VDC	0 mA	2000 mA	15 mA	237 mA	88	2000µF
EC7A-48S12	36-75VDC	12 VDC	0 mA	835 mA	15 mA	235 mA	89	835µF
EC7A-48S15	36-75VDC	15 VDC	0 mA	666 mA	15 mA	237 mA	88	666µF
EC7A-48D12	36-75VDC	±12 VDC	0 mA	±416 mA	10 mA	236 mA	88	416µF
EC7A-48D15	36-75VDC	±15 VDC	0 mA	±333 mA	10 mA	42 mA	86	333µF

Derating Curve

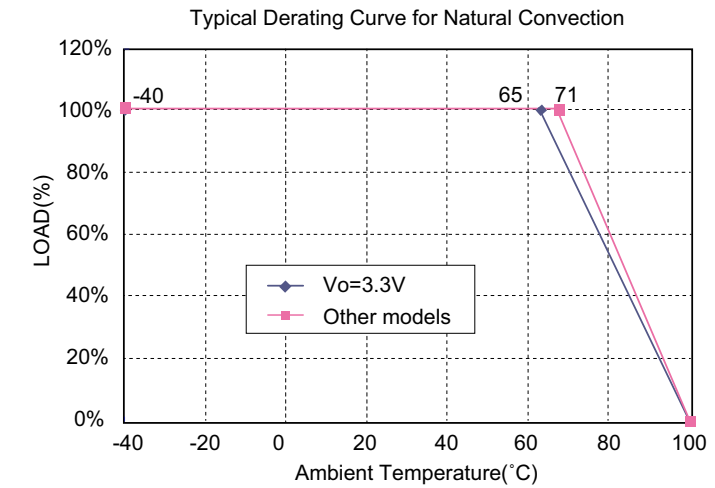

Specifications

All Specifications Typical At Nominal Line, Full Load, and 25°C Unless Otherwise Noted

INPUT SPECIFICATIONS

Input Voltage Range	12V 9-18V	24V 18-36V	48V 36-75V
Input Surge Voltage (100ms max.)	12V 25Vdc max.	24V 50Vdc max.	48V 100Vdc max.
Under voltage lockout	12VIn power up 8.8V	24VIn power up 8V	48VIn power up 17V
Input Filter	12VIn power down 16V	24VIn power up 34V	48VIn power down 32V

OUTPUT SPECIFICATIONS

Voltage Accuracy	±1.5% max.
Voltage Balance (Dual)	±2.0% max.
Transient Response: 75% - 100% Step Load Change	
Error Band	±5% Vout Nominal
Recovery Time	< 300µs
Ripple & Noise, 20MHz BW	75mV pk-pk, max.
Single	100mV pk-pk, max.
Dual	
Temperature Coefficient	±0.05%/°C
Line Regulation (note1)	±0.2% max.
Single	±0.5% max.
Dual	±1.0% max.
Load Regulation (note2)	DIP±0.5% max., SMD±1.0% max.
Single	±1.0% max.
Dual	Continuous
Output Short Circuit Protection	
Over voltage Protection (Zener Diode Clamp, Single Output Only)	
2.5V, 3.3V.....	3.9Vdc typ.
5V.....	6.2Vdc typ.
12V.....	15Vdc typ.
15V.....	18Vdc typ.
Start up time	24(48)S25(33).....120ms typ.
24(48)S05(12).....	60ms typ.
Others	8ms typ.

GENERAL SPECIFICATIONS

Efficiency	See Table
Isolation Voltage	Input/Output 1500VDC min.
Isolation Resistance	10 ⁹ ohm min.
Isolation Capacitance	1000pF typ.
Switching Frequency	380KHz typ.
Operating Ambient Temperature	-40°C to +85°C
De-rating, Above 71°C	Linearly to Zero power at 100°C
Case Temperature (note 4)	100°C max.
Cooling	Natural Convection
Storage Temperature	-40°C to +125°C
Humidity	95% RH max. Non condensing
MTBF.....MIL-STD-217F, GB, 25°C, Full Load	1150K hrs
Dimensions	DIP 1.25 x 0.80 x 0.40 inches (31.8 x 20.3 x 10.2 mm)
	SMD 1.25 x 0.80 x 0.45 inches (31.8 x 20.3 x 11.4 mm)
Case Material	Black Coated Copper with Non-Conductive Base
Weight	18.4 g

NOTE

1. Measured from high line to low line.
2. Measured from full load to 10% load.
3. Suffix "S" to the model number with SMD packages.
4. Maximum case temperature under any operating condition should not be exceeded 100°C.

EC8AW SERIES

15 WATT, 4:1 INPUT RANGE

Visit www.cincon.com for new releases and a wider selection of products

Features

- ◆ 15W Isolated Output
- ◆ DIP-24 Package
- ◆ Very High Efficiency Up to 90%
- ◆ Low No Load Power Consumption
- ◆ 4 : 1 Input Range
- ◆ Regulated Outputs
- ◆ Conductive EMI Meet EN55022 Class A Without External Components
- ◆ Continuous Short Circuit Protection
- ◆ No Tantalum Capacitor Inside
- ◆ CE Mark Meets 2004/108/EC
- ◆ Safety Meets UL60950-1, EN60950-1 and IEC60950-1



Mechanical Dimensions

NOTE: Pin Size is 0.02" Inch (0.5mm) DIA
All Dimensions in Inches (mm)
Tolerance Inches: X.XX±0.02, X.XXX±0.010
Millimeters: X.X±0.5, X.XX±0.25

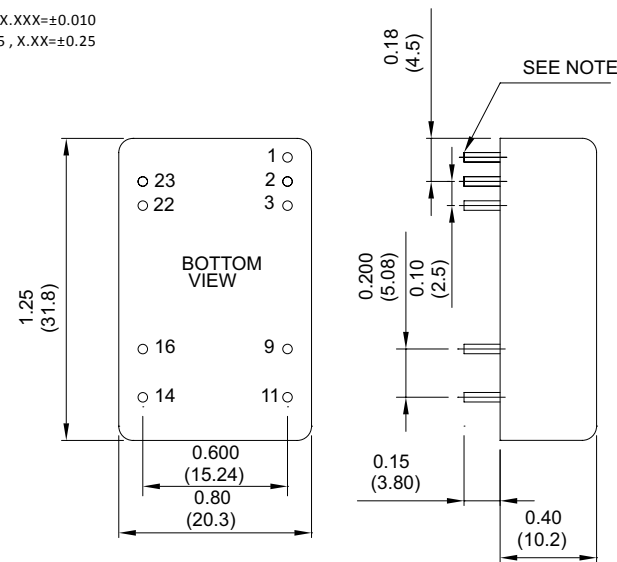

PIN CONNECTION		
Pin	Single Output	Dual Output
1	Remote On/Off	Remote On/Off
2,3	-V Input	-V Input
4,5	NP	NP
9	NP	Common
10	NP	NP
11	NC	-V Output
12	NP	NC
13	NP	NP
14	+V Output	+V Output
15	NP	NP
16	-V Output	Common
20,21,24	NP	NC
22,23	+V Input	+V Input

* NP-NO PIN
* NC-NO CONNECTION WITH PIN

MODEL NUMBER	INPUT VOLTAGE	OUTPUT VOLTAGE	OUTPUT CURRENT		INPUT CURRENT		% EFF.	CAPACITOR LOAD MAX.
			MIN.	MAX.	NO LOAD	FULL LOAD		
EC8AW-24S33	9-36 VDC	3.3 VDC	0 mA	4000 mA	8 mA	625 mA	88	4000µF
EC8AW-24S05	9-36 VDC	5 VDC	0 mA	3000 mA	8 mA	694 mA	90	3000µF
EC8AW-24S12	9-36 VDC	12 VDC	0 mA	1250 mA	8 mA	694 mA	90	1250µF
EC8AW-24S15	9-36 VDC	15 VDC	0 mA	1000 mA	8 mA	694 mA	90	1000µF
EC8AW-24D12	9-36 VDC	±12 VDC	0 mA	±625 mA	8 mA	702 mA	89	625µF
EC8AW-24D15	9-36 VDC	±15 VDC	0 mA	±500 mA	8 mA	694 mA	90	500µF
EC8AW-48S33	18-75 VDC	3.3 VDC	0 mA	4000 mA	6 mA	309 mA	89	4000µF
EC8AW-48S05	18-75 VDC	5 VDC	0 mA	3000 mA	6 mA	347 mA	90	3000µF
EC8AW-48S12	18-75 VDC	12 VDC	0 mA	1250 mA	6 mA	347 mA	90	1250µF
EC8AW-48S15	18-75 VDC	15 VDC	0 mA	1000 mA	6 mA	347 mA	90	1000µF
EC8AW-48D12	18-75 VDC	±12 VDC	0 mA	±625 mA	6 mA	351 mA	89.5	625µF
EC8AW-48D15	18-75 VDC	±15 VDC	0 mA	±500 mA	6 mA	47 mA	90	500µF

Derating Curve

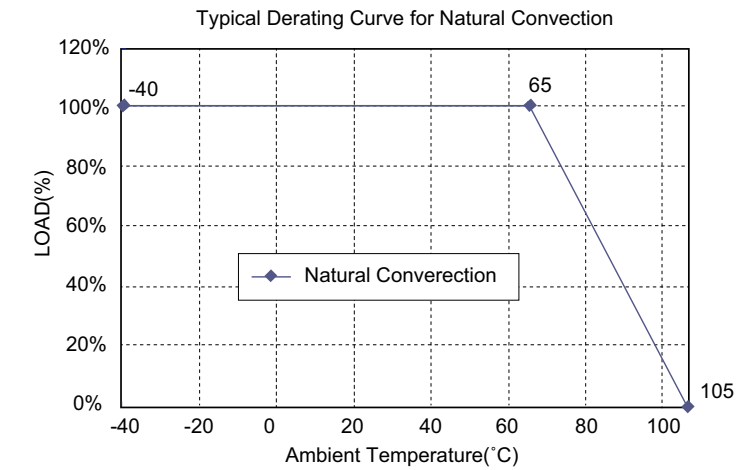

Specifications

All Specifications Typical At Nominal Line, Full Load, and 25°C Unless Otherwise Noted

INPUT SPECIFICATIONS

Input Voltage Range	24V 9-36V
	48V 18-75V
Input Surge Voltage (100ms max.)	24V 50Vdc max.
	48V 100Vdc max.
Under Voltage Lockout	24Vin
	48Vin
Input Filter	CMOS or Open Collector TTL, Referenced to -Vin
Remote On/Off Control	>3.5VDC to Vin or Open Circuit
Logic Compatibility	<1.2VDC
Module On	
Module Off	

OUTPUT SPECIFICATIONS

Voltage Accuracy	±1.5% max.
Voltage Balance (Dual)	±1.0% max.
Transient Response: 75% - 100% Step Load Change	
Error Band	±5% Vout Nominal
Recovery Time	< 250µs
Ripple & Noise, 20MHz BW (note 3)	75mV pk-pk max.
	Dual 75mV pk-pk max.
Temperature Coefficient	±0.2% max.
Line Regulation (note 1)	±0.5% max.
	Dual ±0.5% max.
Load Regulation (note 2)	±1.0% max.
	Dual ±1.0% max.
Cross Regulation (Dual Output) Load Cross	
Variation 10%/100%	±5% max.
Current Limit	110% - 160% Nominal Output
Output Short Circuit Protection	Continuous (Hiccup Mode)
Over Voltage Protection (Zener Diode Clamp)	
	3.3V 3.9Vdc typ.
	5V 6.2Vdc typ.
	12V 15Vdc typ.
	15V 18Vdc typ.
Start up time	15ms typ.

GENERAL SPECIFICATIONS

Efficiency	See Table
Isolation Voltage	Input/Output 1500VDC min.
Isolation Resistance	10 ⁹ ohm min.
Isolation Capacitance	1000pF typ.
Switching Frequency	300KHz typ.
EMI/RFI	Conductive EMI Meet EN55022 Class A
Operating Ambient Temperature	-40°C to +85°C
De-rating, Above 65°C	Linearly to Zero power at 105°C
Case Temperature (note 4)	105°C max.
Cooling	Natural Convection
Storage Temperature	-40°C to +125°C
Humidity	95% RH max. Non condensing
MTBF ... MIL-STD-217F, GB, 25°C, Full Load	XXS33/05 960Khrs typ.
	Others 125Khrs typ.
Dimensions	DIP
	1.25 x 0.80 x 0.40 inches
	(31.8 x 20.3 x 10.2 mm)
Case Material	Black Coated Copper with Non-Conductive Base
Weight	18 g

NOTE

1. Measured from high line to low line.
2. Measured from full load to min. load.
3. Measured with 0.1µF MLCC.
4. Maximum case temperature under any operating condition should not be exceeded 105°C.

EC1SB SERIES

15 WATT, OPEN FRAME

Visit www.cincon.com for new releases and a wider selection of products

Features

- ◆ 13.2W-15W Isolated Output
- ◆ 1.1" x 1" Open Frame Design
- ◆ Efficiency to 89%
- ◆ Regulated Outputs
- ◆ Fixed Switching Frequency
- ◆ Input Under Voltage Protection
- ◆ Over Current Protection
- ◆ Remote On/Off
- ◆ Continuous Short Circuit Protection
- ◆ Fully Isolated 2250VDC
- ◆ CE Mark Meets 2004/108/EC
- ◆ UL60950-1 Approval

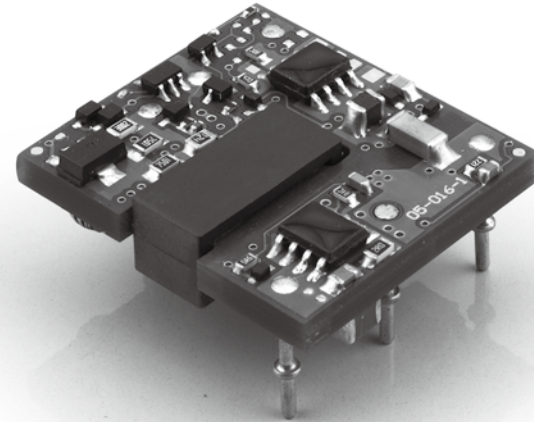

Mechanical Dimensions

All Dimensions in Inches (mm)
 Tolerance Inches: X.XX±0.02, X.X±0.5
 Millimeters: X.XXX±0.10, X.XX±0.25

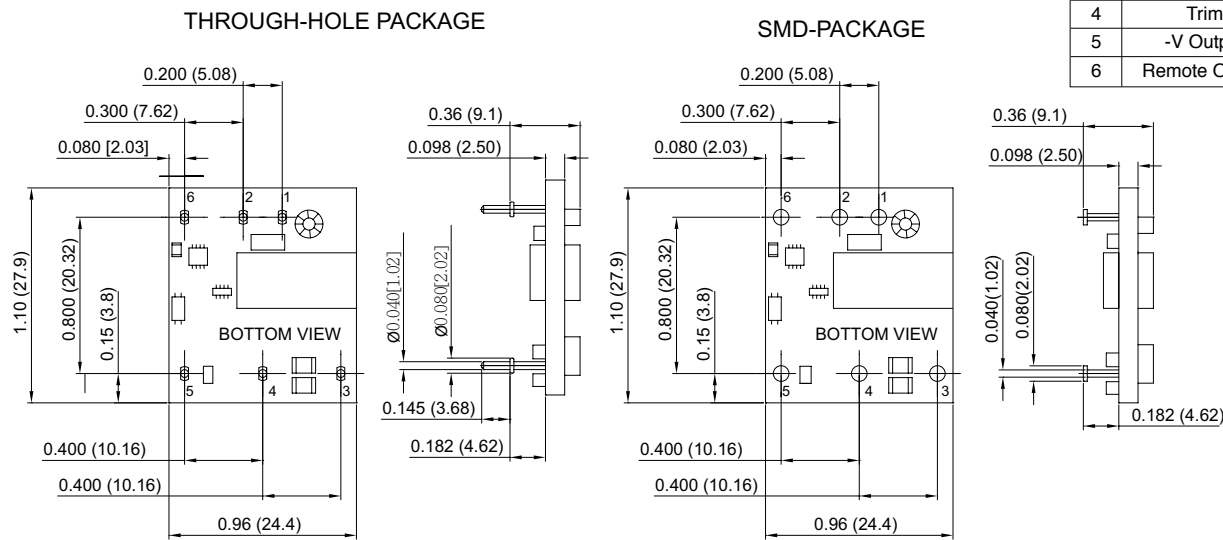

MODEL NUMBER	INPUT VOLTAGE	OUTPUT VOLTAGE	OUTPUT CURRENT		INPUT CURRENT		% EFF.	CAPACITOR LOAD MAX.
			MIN.	MAX.	NO LOAD	FULL LOAD		
EC1SB -24S33	18-36 VDC	3.3 VDC	0 mA	4000 mA	50 mA	639 mA	86	4000µF
EC1SB -24S05	18-36 VDC	5 VDC	0 mA	3000 mA	50 mA	718 mA	87	3000µF
EC1SB -24S12	18-36 VDC	12 VDC	0 mA	1250 mA	40 mA	718 mA	87	1250µF
EC1SB -24S15	18-36 VDC	15 VDC	0 mA	1000 mA	40 mA	718 mA	87	1000µF
EC1SB -48S33	36-75 VDC	3.3 VDC	0 mA	4000 mA	30 mA	320 mA	86	4000µF
EC1SB -48S05	36-75 VDC	5 VDC	0 mA	3000 mA	30 mA	359 mA	87	3000µF
EC1SB -48S12	36-75 VDC	12 VDC	0 mA	1250 mA	30 mA	351 mA	89	1250µF
EC1SB -48S15	36-75 VDC	15 VDC	0 mA	1000 mA	30 mA	351 mA	89	1000µF

Derating Curve

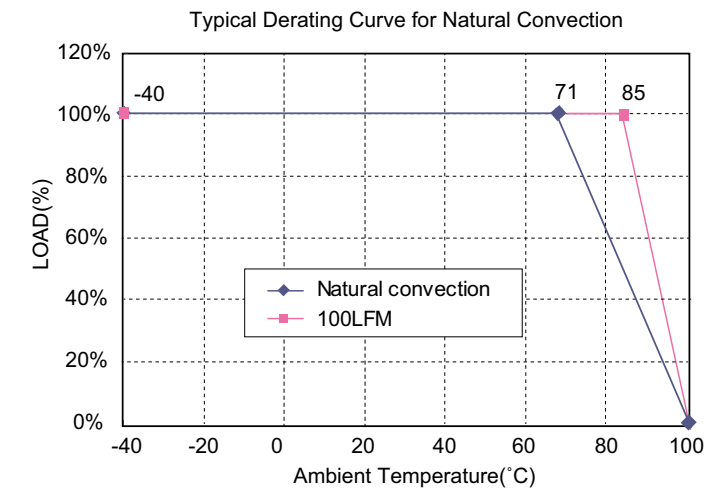

Specifications

All Specifications Typical At Nominal Line, Full Load, and 25°C Unless Otherwise Noted

INPUT SPECIFICATIONS

Input Voltage Range	24V18-36V
	48V 36-75V
Input Surge Voltage (100ms max.)	24V 50Vdc max.
	48V 100Vdc max.
Under Voltage Lockout	24Vin
	power up 17V
	power down 16V
	48Vin
	power up 34V
	power down 32.5V
Input Filter	Capacitive Type
Positive Logic Remote On/Off Control:	
Logic Compatibility	CMOS or Open Collector TTL
Module On	>+5.5VDC to 75Vdc or Open
Module Off	<1.2VDC

OUTPUT SPECIFICATIONS

Voltage Accuracy	±1.5% max.
Transient Response: 25% Step Load Change	<500µs
Ripple and Noise 20MHz BW	Vo=3.3 & 5V
	75mV pk-pk max.
	Vo=12 & 15V
	100mV pk-pk max.
Temperature Coefficient	±0.03%/°C max.
Short Circuit Protection	Continuous
Line Regulation (note 1)	±0.2% max.
Load Regulation (note 2)	±0.2% max.
Over Voltage Protection	Zener or TVS Clamp
External Trim Adj. Range	±10%
Current Limit	110%-140% Nominal Output
Start up time	8ms typ.

GENERAL SPECIFICATIONS

Efficiency	See Table
Isolation Voltage	2250 VDC min.
Isolation Resistance	10 ⁷ ohm min.
Isolation Capacitance	560pF typ.
Switching Frequency	400KHz typ.
Operating Ambient Temperature Range	-40°C to +85°C
Derating, Above 71°C	Linearly to Zero Power at +100°C
Cooling	Natural Convection
Storage Temperature Range	-40°C to +125°C
Humidity	95% RH max. Non condensing
MTBF	MIL-STD-217F, GB, 25°C, Full Load
Dimensions	1.10 x 0.96 x 0.36 inches
	(27.9 x 24.4 x 9.1 mm)
Structure	Non-potted With Open Frame Type
Weight	8.8g

NOTE

1. Measured from high line to low line.
2. Measured from full load to min. load.
3. Suffix "N" to the model number with negative logic remote On/Off
 Module On <1.2VDC
 Module Off >+5.5VDC to 50VDC or Open Circuit
4. Suffix "S" to the model number with SMD package.
5. The output ripple and noise is measured with 10µF tantalum and 1µF ceramic capacitor across output.

EC2SB SERIES

10 WATT, 2:1 INPUT RANGE

Visit www.cincon.com for new releases and a wider selection of products

Features

- ◆ 10W Isolated Output
- ◆ Efficiency to 87%
- ◆ 2 : 1 Input Range
- ◆ Regulated Outputs
- ◆ Fixed Switching Frequency
- ◆ Input Under Voltage Protection
- ◆ Over Current Protection
- ◆ Remote On/Off
- ◆ Continuous Short Circuit Protection
- ◆ Conductive EMI Meets EN55022 Class A
- ◆ Without Tantalum Capacitors Inside
- ◆ CE Mark Meets 2004/108/EC
- ◆ Safety Meets UL60950-1, EN60950-1, and IEC60950-1

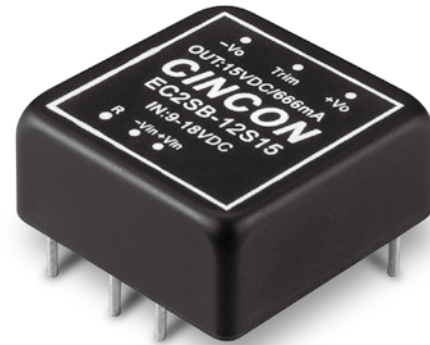

Mechanical Dimensions

NOTE: Pin Size is 0.04" ±0.004 Inch (1.0 mm) DIA
All Dimensions in Inches (mm)
Tolerance Inches: X.XX±0.02, X.XXX±0.010
Millimeters: X.X±0.5, X.XX±0.25

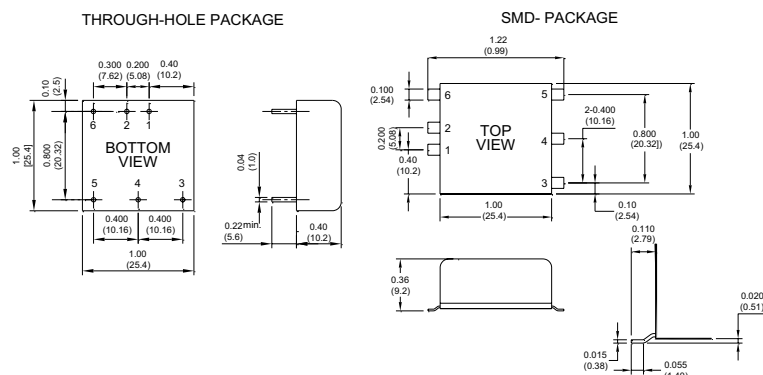

PIN CONNECTION		
PIN	Single Output	Dual Output
1	+Input	+Input
2	-Input	-Input
3	+V Output	+V Output
4	Trim	Common
5	-V Output	-V Output
6	Remote	Remote

MODEL NUMBER	INPUT VOLTAGE	OUTPUT VOLTAGE	OUTPUT CURRENT		INPUT CURRENT		% EFF.	CAPACITOR LOAD MAX.
			MIN.	MAX.	NO LOAD	FULL LOAD		
EC2SB-05S33	4.7-9 VDC	3.3 VDC	0 mA	2500 mA	120 mA	1897 mA	87	2470µF
EC2SB-05S05	4.7-9 VDC	5 VDC	0 mA	2000 mA	120 mA	2299 mA	87	2000µF
EC2SB-05S12	4.7-9 VDC	12 VDC	0 mA	833 mA	50 mA	2298 mA	87	940µF
EC2SB-05S15	4.7-9 VDC	15 VDC	0 mA	666 mA	50 mA	2297 mA	87	690µF
EC2SB-05D05	4.7-9 VDC	±5 VDC	0 mA	±1000 mA	50 mA	2353 mA	85	1000µF
EC2SB-05D12	4.7-9 VDC	±12 VDC	0 mA	±416 mA	50 mA	2295 mA	87	440µF
EC2SB-05D15	4.7-9 VDC	±15 VDC	0 mA	±333 mA	50 mA	2297 mA	87	330µF
EC2SB-12S33	9-18 VDC	3.3 VDC	0 mA	2500 mA	30 mA	838 mA	82	2470µF
EC2SB-12S05	9-18 VDC	5 VDC	0 mA	2000 mA	30 mA	980 mA	85	2000µF
EC2SB-12S12	9-18 VDC	12 VDC	0 mA	833 mA	35 mA	957 mA	87	940µF
EC2SB-12S15	9-18 VDC	15 VDC	0 mA	666 mA	35 mA	956 mA	87	690µF
EC2SB-12D05	9-18 VDC	±5 VDC	0 mA	±1000 mA	45 mA	980 mA	85	1000µF
EC2SB-12D12	9-18 VDC	±12 VDC	0 mA	±416 mA	45 mA	957 mA	87	440µF
EC2SB-12D15	9-18 VDC	±15 VDC	0 mA	±333 mA	45 mA	957 mA	87	330µF
EC2SB-24S33	18-36 VDC	3.3 VDC	0 mA	2500 mA	25 mA	419 mA	82	2470µF
EC2SB-24S05	18-36 VDC	5 VDC	0 mA	2000 mA	25 mA	490 mA	85	2000µF
EC2SB-24S12	18-36 VDC	12 VDC	0 mA	833 mA	25 mA	478 mA	87	940µF
EC2SB-24S15	18-36 VDC	15 VDC	0 mA	666 mA	25 mA	478 mA	87	690µF
EC2SB-24D05	18-36 VDC	±5 VDC	0 mA	±1000 mA	25 mA	490 mA	85	1000µF
EC2SB-24D12	18-36 VDC	±12 VDC	0 mA	±416 mA	25 mA	478 mA	87	440µF
EC2SB-24D15	18-36 VDC	±15 VDC	0 mA	±333 mA	25 mA	478 mA	87	330µF
EC2SB-48S33	36-75 VDC	3.3 VDC	0 mA	2500 mA	20 mA	212 mA	81	2470µF
EC2SB-48S05	36-75 VDC	5 VDC	0 mA	2000 mA	20 mA	245 mA	85	2000µF
EC2SB-48S12	36-75 VDC	12 VDC	0 mA	833 mA	20 mA	239 mA	87	940µF
EC2SB-48S15	36-75 VDC	15 VDC	0 mA	666 mA	20 mA	239 mA	87	690µF
EC2SB-48D05	36-75 VDC	±5 VDC	0 mA	±1000 mA	20 mA	245 mA	85	1000µF
EC2SB-48D12	36-75 VDC	±12 VDC	0 mA	±416 mA	20 mA	239 mA	87	440µF
EC2SB-48D15	36-75 VDC	±15 VDC	0 mA	±333 mA	20 mA	239 mA	87	330µF

Derating Curve

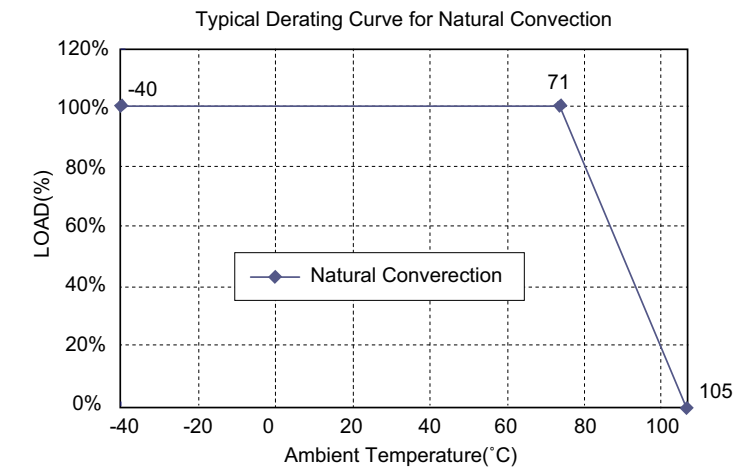

Specifications

All Specifications Typical At Nominal Line, Full Load, and 25°C Unless Otherwise Noted

INPUT SPECIFICATIONS

Input Voltage Range	5V 4.7-9V 12V 9-18V 24V 18-36V 48V 36-75V power up 4.4V power down 4.2V 48V 8.8V power up 8V power down 8V 48V 16V power up 34V power down 32V
Under voltage lockout	5Vin 12Vin 24Vin 48Vin
Input Surge Voltage (100ms max.)	EC2SB-05Sxx/ 05Dxx 12Vdc max. EC2SB-12Sxx/ 12Dxx 25Vdc max. EC2SB-24Sxx/ 24Dxx 50Vdc max. EC2SB-48Sxx/ 48Dxx 100Vdc max. Standard PI Type SMD LC Type
Input Filter	
Positive Logic Remote On/Off Control:	
Logic Compatibility	CMOS or Open Collector TTL
Module On	>+5.5V to 75VDC or Open Circuit
Module Off	<1.2VDC

OUTPUT SPECIFICATIONS

Voltage Accuracy	±1.5% max.
Voltage Balance (Dual)	±2.0% max.
Transient Response: 25% Step Load Change	< 500µs
Ripple and Noise, 20MHz BW (note 3)	50mV pk-pk max. SMD 100mV pk-pk max.
Temperature Coefficient	±0.03%/°C max.
Short Circuit Protection	Continuous
Line Regulation (note 1)	Single ±0.2% max. SMD ±0.3% max. Dual ±0.5% max.

Load Regulation (note 2)	Single ±0.2% max. SMD ±0.5% max. Dual ±1.0% max.
Cross Regulation (Dual output)	Load cross variation 10%/100% ±5% max.
Over Voltage Protection	Zener or TVS Clamp
External Trim Adj. Range (single output models only)	±10%
Current Limit	110%~140% Nominal Output
Start up time	20ms max.

GENERAL SPECIFICATIONS

Efficiency	See Table
Isolation Voltage	1500 VDC min.
Isolation Resistance	10 ⁹ ohm min.
Isolation Capacitance	1000pF typ.
Switching Frequency	350KHz typ.
EMI/RFI (Standard)	Conductive EMI Meets EN55022 Class A
Operating Ambient Temperature Range	-40°C to +85°C
Derating, Above 71°C	Linearly to Zero Power at +105°C
Case Temperature (note 4)	105°C max.
Cooling	Natural Convection
Storage Temperature Range	-55°C to +125°C
Humidity	95% RH max. Non condensing
MTBF MIL-STD-217-F, GB, 25°C, Full Load	1200Khrs typ.
Dimensions	Standard 1.00 x 1.00 x 0.4 inches (25.4 x 25.4 x 10.2 mm)
	SMD 1.00 x 1.00 x 0.36 inches (25.4 x 25.4 x 9.2 mm)
Case Material	Black Coated Copper with Non-Conductive Base
Weight	18 g

NOTE

1. Measured from high line to low line.
2. Measured from full load to min. load.
3. The output ripple and noise is measured with 10µF tantalum and 1µF ceramic capacitor across output.
4. Maximum case temperature under any operating condition should not be exceeded 105°C.
5. Suffix "S" to the model number with SMD packages.

EC2SBW SERIES

10 WATT, 4:1 INPUT RANGE

Visit www.cincon.com for new releases and a wider selection of products

Features

- ◆ 10W Isolated Output
- ◆ 1" x 1" x 0.4" Shielded Metal Case
- ◆ Efficiency to 86%
- ◆ 4 : 1 Input Range
- ◆ Regulated Outputs
- ◆ Input Under Voltage Protection
- ◆ Remote On/Off
- ◆ Continuous Short Circuit Protection
- ◆ Without Tantalum Capacitors Inside
- ◆ CE Mark Meets 2004/108/EC
- ◆ Safety Meets UL60950-1, EN60950-1, and IEC60950-1

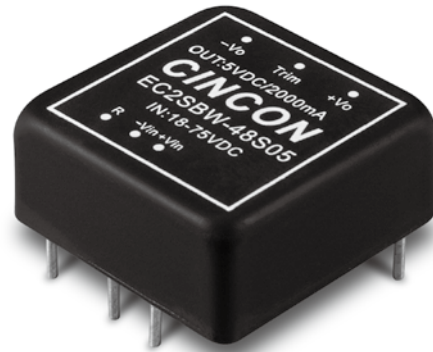

Mechanical Dimensions

NOTE: Pin Size is 0.04" ±0.004 Inch (1.0 mm) DIA
All Dimensions in Inches (mm)
Tolerance Inches: X.XX=±0.02, X.XXX=±0.010
Millimeters: X.X=±0.5, X.XX=±0.25

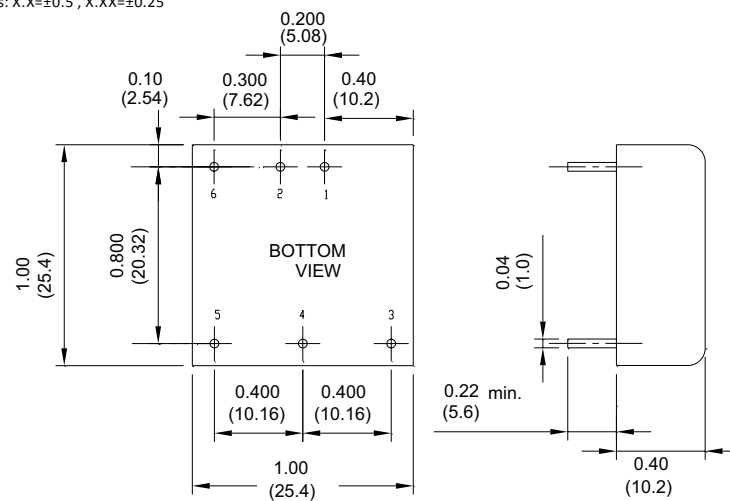

PIN CONNECTION		
PIN	Single Output	Dual Output
1	+Input	+Input
2	-Input	-Input
3	+V Output	+V Output
4	Trim	Common
5	-V Output	-V Output
6	Remote	Remote

MODEL NUMBER	INPUT VOLTAGE	OUTPUT VOLTAGE	OUTPUT CURRENT		INPUT CURRENT		% EFF.	CAPACITOR LOAD MAX.
			MIN.	MAX.	NO LOAD	FULL LOAD		
EC2SBW-24S33	9-36 VDC	3.3 VDC	0 mA	2500 mA	5 mA	425 mA	81	3300µF
EC2SBW-24S05	9-36 VDC	5 VDC	0 mA	2000 mA	5 mA	496 mA	84	2200µF
EC2SBW-24S12	9-36 VDC	12 VDC	0 mA	835 mA	10 mA	486 mA	86	1000µF
EC2SBW-24S15	9-36 VDC	15 VDC	0 mA	666 mA	10 mA	486 mA	86	680µF
EC2SBW-24D05	9-36 VDC	± 5 VDC	0 mA	±1000 mA	10 mA	496 mA	84	1200µF
EC2SBW-24D12	9-36 VDC	± 12 VDC	0 mA	±416 mA	10 mA	486 mA	86	470µF
EC2SBW-24D15	9-36 VDC	± 15 VDC	0 mA	±333 mA	10 mA	486 mA	86	330µF
EC2SBW-48S33	18-75 VDC	3.3 VDC	0 mA	2500 mA	5 mA	210 mA	82	3300µF
EC2SBW-48S05	18-75 VDC	5 VDC	0 mA	2000 mA	5 mA	248 mA	84	2200µF
EC2SBW-48S12	18-75 VDC	12 VDC	0 mA	835 mA	5 mA	243 mA	86	1000µF
EC2SBW-48S15	18-75 VDC	15 VDC	0 mA	666 mA	5 mA	243 mA	86	680µF
EC2SBW-48D05	18-75 VDC	± 5 VDC	0 mA	±1000 mA	5 mA	248 mA	84	1200µF
EC2SBW-48D12	18-75 VDC	± 12 VDC	0 mA	±416 mA	8 mA	243 mA	86	470µF
EC2SBW-48D15	18-75 VDC	± 15 VDC	0 mA	±333 mA	8 mA	243 mA	86	330µF

Derating Curve

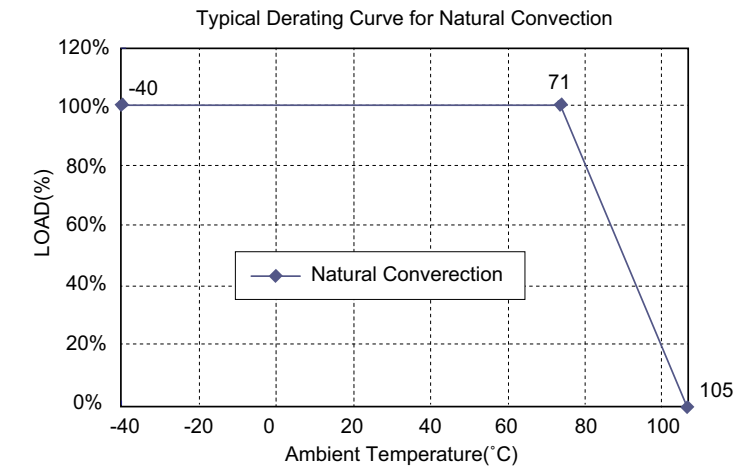

Specifications

All Specifications Typical At Nominal Line, Full Load, and 25°C Unless Otherwise Noted

INPUT SPECIFICATIONS

Input Voltage Range	4V 9-36V 48V 18-75V 24V 50Vdc max.
Input Surge Voltage (100ms max.)	48V 100Vdc max. power up 8.8V typ. power down 8.0V typ.
Input Under voltage lockout	24V in 17V typ. 48V in 16V typ. LC Type
Input Filter	
Positive Logic Remote on/off Control (note 3):	
Logic Compatibility	CMOS or Open Collector TTL, Ref. to -Vin
Module On	>+3.5V to 36VDC or Open Circuit
Module Off	< 1.2VDC

OUTPUT SPECIFICATIONS

Voltage Accuracy	±1.5% max.
Voltage Balance (Dual)	±1.0% max.
Transient Response: 75%-100% Step Load Change	
Error Band	5% Vout nominal
Recovery Time	< 500µs
Ripple & Noise, 20MHz BW (note 4)	
Vo=3.3 & 5V	75mV pk-pk max.
Vo=12 & 15V	100mV pk-pk max.
Temperature Coefficient	±0.03%/°C
Short Circuit Protection	Continuous
Line Regulation (note 1)	±0.5% max.
Load Regulation (note 2)	±0.5% max. Dual ±1.0% max.
Cross Regulation(Dual output)	
Load cross variation 25%/100%	±5% max
Over Voltage Protection	Zener or TVS Clamp
External Trim Adj. Range (Single Output Models Only)	±10%
Start up time	3.5ms typ.

GENERAL SPECIFICATIONS

Efficiency	See Table
Isolation Voltage	1500 VDC min.
Isolation Resistance	10 ⁹ ohm min.
Isolation Capacitance	1000pF typ.
Switching Frequency	100KHz min.
Operating Ambient Temperature Range	-40°C to +85°C
Derating, Above 71°C	Linearly to Zero Power at +105°C
Case Temperature (note 5)	105°C max.
Cooling	Natural Convection
Storage Temperature Range	-55°C to +125°C
Humidity	95% RH max. Non condensing
MTBF	MIL-STD-217F, GB 1300Khrs typ.
Dimensions	1.00 x 1.00 x 0.4 inches (25.4 x 25.4 x 10.2 mm)
Case Material	Black Coated Copper with Non-Conductive Base
Weight	18 g

NOTE

1. Measured from high line to low line.
2. Measured from full load to min. load.
3. Suffix "N" to the model number with negative logic remote On/Off
Module On < 1.2VDC
Module Off >+3.5VDC to 36VDC or open circuit
4. The output ripple and noise is measured with 10µF tantalum and 1µF ceramic capacitor across output.
5. Maximum case temperature under any operating condition should not be exceeded 105°C.

EC3SB SERIES

15 WATT, 2:1 INPUT RANGE

Visit www.cincon.com for new releases and a wider selection of products

Features

- ◆ 15W Isolated Output
- ◆ Efficiency to 90%
- ◆ 2 : 1 Input Rang
- ◆ Regulated Outputs
- ◆ Fixed Switching Frequency
- ◆ Input Under Voltage Protection
- ◆ Over Current Protection
- ◆ Remote On/Off
- ◆ Continuous Short Circuit Protection
- ◆ Without Tantalum Capacitors Inside
- ◆ CE Mark Meets 2004/108/EC
- ◆ Safety Meets UL60950-1, EN60950-1, and IEC60950-1

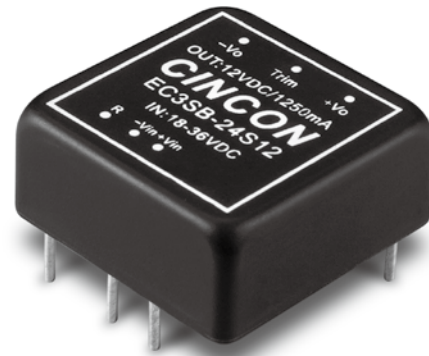

Mechanical Dimensions

NOTE: Pin Size is 0.04" ±0.004 Inch (1.0 mm) DIA
All Dimensions in Inches (mm)
Tolerance Inches: X.XX±0.02, X.XXX±0.010
Millimeters: X.X±0.5, X.XX±0.25

THROUGH-HOLE PACKAGE

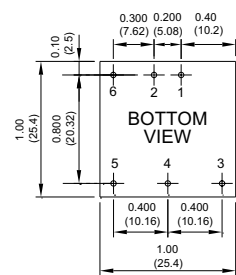

SMD- PACKAGE

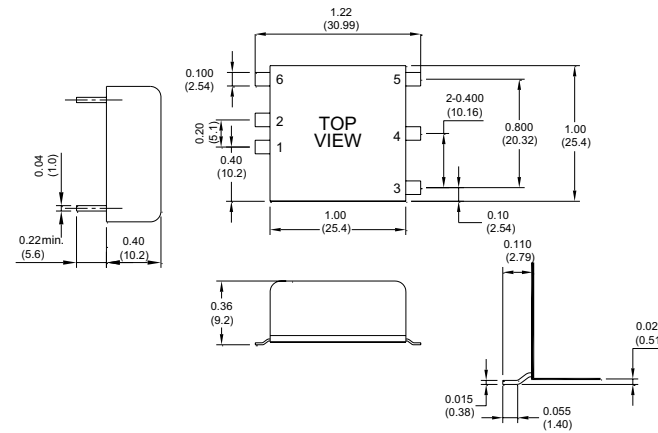

PIN CONNECTION		
PIN	Single Output	Dual Output
1	+Input	+Input
2	-Input	-Input
3	+V Output	+V Output
4	Trim	Common
5	-V Output	-V Output
6	Remote	Remote

MODEL NUMBER	INPUT VOLTAGE	OUTPUT VOLTAGE	OUTPUT CURRENT		INPUT CURRENT		% EFF.	CAPACITOR LOAD MAX.
			MIN.	MAX.	NO LOAD	FULL LOAD		
EC3SB-12S33	9-18 VDC	3.3 VDC	0 mA	4000 mA	90 mA	1280 mA	85	4000µF
EC3SB-12S05	9-18 VDC	5 VDC	0 mA	3000 mA	85 mA	1453 mA	88	3000µF
EC3SB-12S12	9-18 VDC	12 VDC	0 mA	1250 mA	70 mA	1420 mA	88	1330µF
EC3SB-12S15	9-18 VDC	15 VDC	0 mA	1000 mA	70 mA	1420 mA	88	1000µF
EC3SB-12D05	9-18 VDC	±5 VDC	0 mA	±1500 mA	45 mA	1470 mA	85	1470µF
EC3SB-12D12	9-18 VDC	±12 VDC	0 mA	±625 mA	45 mA	1436 mA	87	660µF
EC3SB-12D15	9-18 VDC	±15 VDC	0 mA	±500 mA	45 mA	1420 mA	88	550µF
EC3SB-24S33	18-36 VDC	3.3 VDC	0 mA	4000 mA	50 mA	640 mA	86	4000µF
EC3SB-24S05	18-36 VDC	5 VDC	0 mA	3000 mA	50 mA	718 mA	89	3000µF
EC3SB-24S12	18-36 VDC	12 VDC	0 mA	1250 mA	20 mA	695 mA	90	1330µF
EC3SB-24S15	18-36 VDC	15 VDC	0 mA	1000 mA	20 mA	695 mA	90	1000µF
EC3SB-24D05	18-36 VDC	±5 VDC	0 mA	±1500 mA	25 mA	726 mA	86	1470µF
EC3SB-24D12	18-36 VDC	±12 VDC	0 mA	±625 mA	25 mA	710 mA	88	660µF
EC3SB-24D15	18-36 VDC	±15 VDC	0 mA	±500 mA	25 mA	702 mA	89	550µF
EC3SB-48S33	36-75 VDC	3.3 VDC	0 mA	4000 mA	25 mA	320 mA	86	4000µF
EC3SB-48S05	36-75 VDC	5 VDC	0 mA	3000 mA	30 mA	359 mA	88	3000µF
EC3SB-48S12	36-75 VDC	12 VDC	0 mA	1250 mA	20 mA	347 mA	90	1330µF
EC3SB-48S15	36-75 VDC	15 VDC	0 mA	1000 mA	20 mA	351 mA	90	1000µF
EC3SB-48D05	36-75 VDC	±5 VDC	0 mA	±1500 mA	20 mA	363 mA	86	1470µF
EC3SB-48D12	36-75 VDC	±12 VDC	0 mA	±625 mA	20 mA	355 mA	88	660µF
EC3SB-48D15	36-75 VDC	±15 VDC	0 mA	±500 mA	20 mA	351 mA	89	550µF

Derating Curve

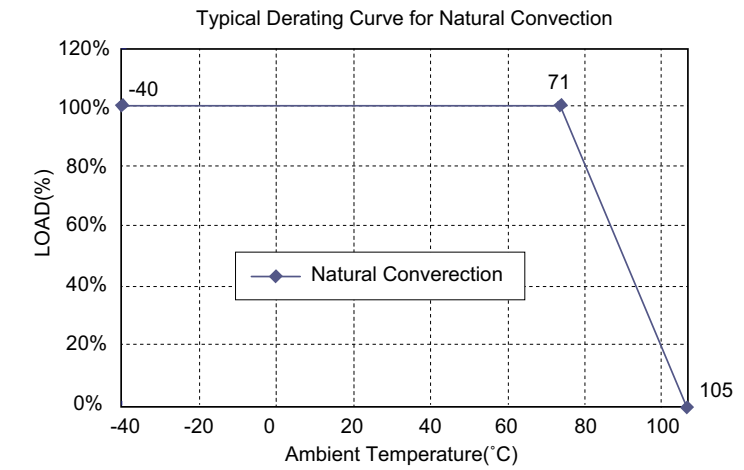

Specifications

All Specifications Typical At Nominal Line, Full Load, and 25°C Unless Otherwise Noted

INPUT SPECIFICATIONS

Input Voltage Range	12V 9-18V 24V 18-36V 48V 36-75V
Input Under voltage lockout	12Vin power up 8.8V 24Vin power up 17V 48Vin power up 16V power down 34V power down 32V
Input Surge Voltage (100ms max.)	25Vdc max. 50Vdc max. 100Vdc max.
Input Filter	Through-Hole Type: PI Type SMD Type: LC Type
Positive Logic Remote On/Off Control:	
Logic Compatibility	CMOS or Open Collector TTL
Module On	>+5.5V to 75VDC or Open Circuit
Module Off	<1.2VDC

OUTPUT SPECIFICATIONS

Voltage Accuracy	±1.5% max.
Voltage Balance (Dual)	±2.0% max.
Transient Response: 25% Step Load Change	< 500µs
Ripple and Noise, 20MHz BW (note 3)	50mV pk-pk max. 120mV pk-pk max.
Temperature Coefficient	±0.03%/°C
Short Circuit Protection	Continuous
Line Regulation (note 1)	DIP±0.2% max., SMD±0.3% max.
	±0.5% max.
Load Regulation (note 2)	DIP±0.2% max., SMD±0.5% max.
	±1.0% max.
Cross Regulation (Dual output)	
Load cross variation 10%/100%	±5% max.
Over Voltage Protection	Zener or TVS Clamp
External Trim Adj. Range	±10%
Current Limit	110%-140% Nominal Output
Start up time	20ms max.

GENERAL SPECIFICATIONS

Efficiency	See Table
Isolation Voltage	1500 VDC min.
Isolation Resistance	10 ⁹ ohm min.
Isolation Capacitance	1000pF typ.
Switching Frequency	350KHz typ.
Operating Ambient Temperature Range	-40°C to +85°C
Derating, Above 71°C	Linearly to Zero Power at +105°C
Case Temperature (note 4)	105°C
Cooling	Natural Convection
Storage Temperature Range	-55°C to +125°C
Humidity	95% RH max. Non condensing
MTBF MIL-STD-217-F, GB, 25°C, Full Load	1200Khrs typ.
Dimensions	DIP: 1.00 x 1.00 x 0.4 inches (25.4 x 25.4 x 10.2 mm)
	SMD: 1.00 x 1.00 x 0.36 inches (25.4 x 25.4 x 9.2 mm)
Case Material	Black Coated Copper with Non-Conductive Base
Weight	18 g

NOTE

1. Measured from high line to low line.
2. Measured from full load to min. load.
3. The output ripple and noise is measured with 10µF tantalum and 1µF ceramic capacitor across output.
4. Maximum case temperature under any operating condition should not be exceeded 105°C.
5. Suffix "S" to the model number with SMD packages.

EC3SBW SERIES

15 WATT, 4:1 INPUT RANGE

Visit www.cincon.com for new releases and a wider selection of products

Features

- ◆ 15W Isolated Output
- ◆ 1" x 1" x 0.4" Shielded Metal Case
- ◆ Efficiency to 88%
- ◆ 4 : 1 Input Range
- ◆ Regulated Outputs
- ◆ Fixed Switching Frequency
- ◆ Input Under Voltage Protection
- ◆ Over Current Protection
- ◆ Remote On/Off
- ◆ Continuous Short Circuit Protection
- ◆ Without Tantalum Capacitors inside
- ◆ CE Mark Meets 2004/108/EC
- ◆ Safety Meets UL60950-1, EN60950-1, and IEC60950-1

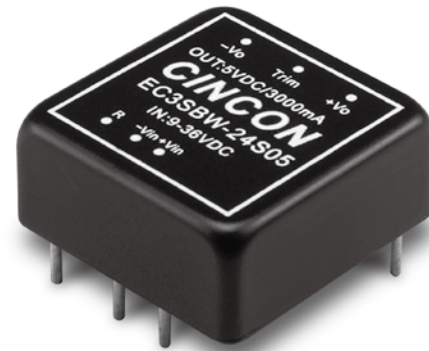

Mechanical Dimensions

NOTE: Pin Size is 0.04" ±0.004 Inch (1.0 mm) DIA
All Dimensions in Inches (mm)
Tolerance Inches: X.XX=±0.02, X.XXX=±0.010
Millimeters: X.X=±0.5, X.XX=±0.25

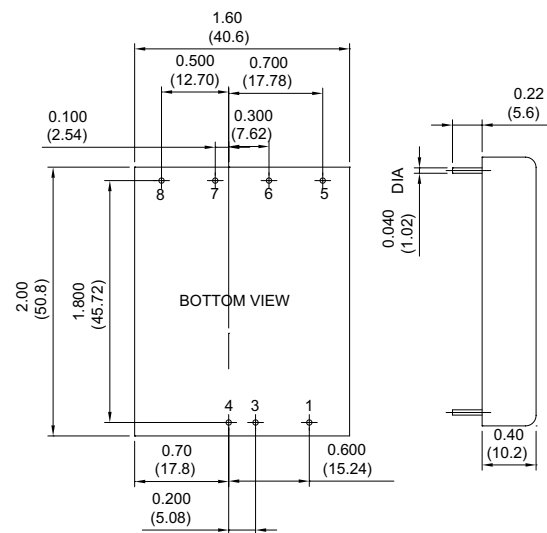

PIN CONNECTION		
PIN	Single Output	Dual Output
1	+Input	+Input
2	-Input	-Input
3	+V Output	+V Output
4	Trim	Common
5	-V Output	-V Output
6	Remote	Remote

MODEL NUMBER	INPUT VOLTAGE	OUTPUT VOLTAGE	OUTPUT CURRENT		INPUT CURRENT		% EFF.	CAPACITOR LOAD MAX.
			MIN.	MAX.	NO LOAD	FULL LOAD		
EC3SBW-24S33	9-36 VDC	3.3 VDC	0 mA	4000 mA	60 mA	632 mA	87	4000µF
EC3SBW-24S05	9-36 VDC	5 VDC	0 mA	3000 mA	70 mA	718 mA	87	3000µF
EC3SBW-24S12	9-36 VDC	12 VDC	0 mA	1250 mA	30 mA	718 mA	87	1250µF
EC3SBW-24S15	9-36 VDC	15 VDC	0 mA	1000 mA	30 mA	710 mA	88	1000µF
EC3SBW-24D05	9-36 VDC	±5 VDC	0 mA	±1500 mA	30 mA	735 mA	85	1500µF
EC3SBW-24D12	9-36 VDC	±12 VDC	0 mA	±625 mA	30 mA	718 mA	87	625µF
EC3SBW-24D15	9-36 VDC	±15 VDC	0 mA	±500 mA	30 mA	710 mA	88	470µF
EC3SBW-48S33	18-75 VDC	3.3 VDC	0 mA	4000 mA	40 mA	313 mA	88	4000µF
EC3SBW-48S05	18-75 VDC	5 VDC	0 mA	3000 mA	40 mA	355 mA	88	3000µF
EC3SBW-48S12	18-75 VDC	12 VDC	0 mA	1250 mA	20 mA	359 mA	87	1250µF
EC3SBW-48S15	18-75 VDC	15 VDC	0 mA	1000 mA	20 mA	359 mA	87	1000µF
EC3SBW-48D05	18-75 VDC	±5 VDC	0 mA	±1500 mA	20 mA	368 mA	85	1500µF
EC3SBW-48D12	18-75 VDC	±12 VDC	0 mA	±625 mA	20 mA	359 mA	87	625µF
EC3SBW-48D15	18-75 VDC	±15 VDC	0 mA	±500 mA	20 mA	359 mA	87	470µF

Derating Curve

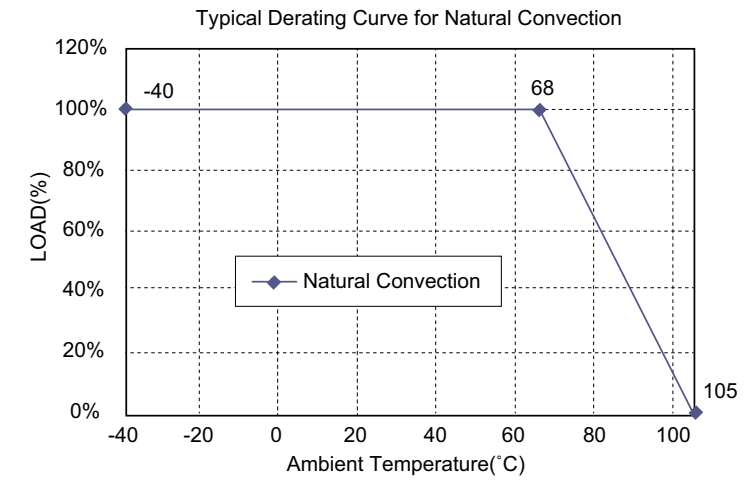

Specifications

All Specifications Typical At Nominal Line, Full Load, and 25°C Unless Otherwise Noted

INPUT SPECIFICATIONS

Input Voltage Range	24V 9-36V 48V 18-75V
Input Surge Voltage (100ms max.)	24V 50Vdc max. 48V 100Vdc max.
Under voltage lockout	24Vin 48Vin power up 8.8V typ. power down 8.0V typ. power up 17V typ. power down 16V typ. LC Type
Input Filter	CMOS or Open Collector TTL, Ref. to -Vin
Positive Logic Remote on/off Control: Logic Compatibility	>+3.5 to 75VDC or Open Circuit < 1.2VDC
Module On	
Module Off	

OUTPUT SPECIFICATIONS

Voltage Accuracy	±1.5% max.
Voltage Balance (Dual)	±2.0% max.
Transient Response: 75%-100% Step Load Change.	
Error Band	±5% Vout nominal
Recovery Time	< 250µs
Ripple & Noise, 20MHz BW (note 3)	
Vo=3.3 & 5V	75mV p-p max.
Vo=12 & 15V	100mV p-p max.
Temperature Coefficient	±0.03%/°C
Short Circuit Protection	Continuous
Line Regulation (note 1)	Single Dual ±0.2% max. ±0.5% max.
Load Regulation (note 2)	Single Dual ±0.2% max. ±1.0% max.
Cross Regulation (Dual output)	
Load cross variation 10%/100%	±5% max.
Over Voltage Protection	Zener or TVS Clamp
External Trim Adj. Range (single output models only)	±10%
Current Limit	110%-170% Nominal Output
Start up time	20ms max.

GENERAL SPECIFICATIONS

Efficiency	See Table
Isolation Voltage	1500 VDC min.
Isolation Resistance	10 ⁹ ohm min.
Isolation Capacitance	1000pF typ.
Switching Frequency	400KHz typ.
Operating Ambient Temperature Range	-40°C to +85°C
Derating, Above 68°C	Linearly to Zero Power at +105°C
Case Temperature (note4)	105°C
Cooling	Natural Convection
Storage Temperature Range	-55°C to +125°C
Humidity	95% RH max. Non condensing
MTBF .. MIL-STD-217F, GB, 25°C, Full Load	S33/S05 950Khrs typ. Others 1300Khrs typ.
Dimensions	1.00 x 1.00 x 0.40 inches (25.4x25.4x10.2 mm)
Case Material	Black Coated Copper with Non-Conductive Base
Weight	18 g

NOTE

1. Measured from high line to low line.
2. Measured from full load to min. load.
3. The output ripple and noise is measured with 10µF tantalum and 1µF ceramic capacitor across output.
4. Maximum case temperature under any operating condition should not be exceeded 105°C.

EC4SBW SERIES

20 WATT, 4:1 INPUT RANGE

Visit www.cincon.com for new releases and a wider selection of products

Features

- ◆ 20W Isolated Output
- ◆ 1" x 1" x 0.4" Shielded Metal Case
- ◆ Very High Efficiency Up to 89%
- ◆ Low No Load Power Consumption
- ◆ 4 : 1 Input Range
- ◆ Regulated Outputs
- ◆ Fixed Switching Frequency
- ◆ Input Under Voltage Protection
- ◆ Over Current Protection
- ◆ Remote On/Off
- ◆ Continuous Short Circuit Protection
- ◆ Without Tantalum Capacitors Inside
- ◆ CE Mark Meets 2004/108/EC
- ◆ Safety Meets UL60950-1, EN60950-1, and IEC60950-1

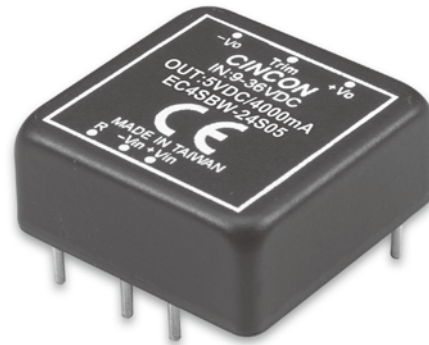

Mechanical Dimensions

All Dimensions in Inches (mm)
 Tolerance Inches: X.XX±0.04, X.XXX±0.010
 Millimeters: X.X±0.5, X.XX±0.25

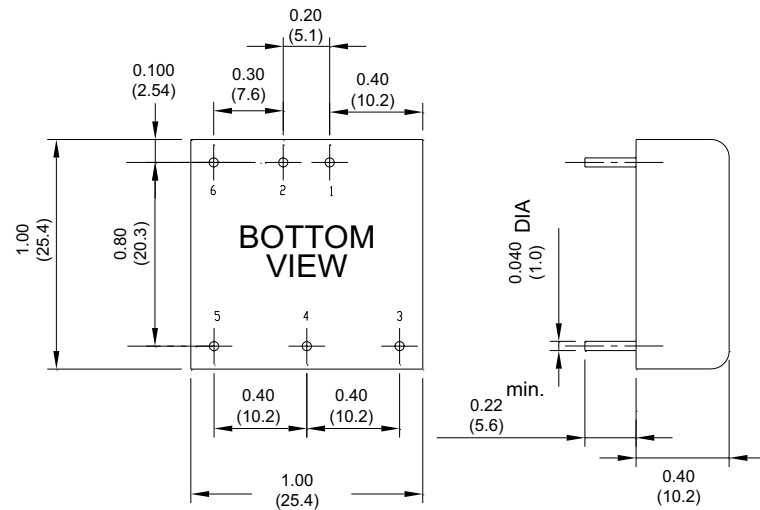

PIN CONNECTION		
PIN	Single Output	Dual Output
1	+Input	+Input
2	-Input	-Input
3	+V Output	+V Output
4	Trim	Common
5	-V Output	-V Output
6	Remote	Remote

MODEL NUMBER	INPUT VOLTAGE	OUTPUT VOLTAGE	OUTPUT CURRENT		INPUT CURRENT		% EFF.	CAPACITOR LOAD MAX.
			MIN.	MAX.	NO LOAD	FULL LOAD		
EC4SBW-24S33	9-36 VDC	3.3 VDC	0 mA	4500 mA	10 mA	781 mA	87	5000µF
EC4SBW-24S05	9-36 VDC	5 VDC	0 mA	4000 mA	10 mA	926 mA	89	4000µF
EC4SBW-24S12	9-36 VDC	12 VDC	0 mA	1670 mA	10 mA	936 mA	88	1650µF
EC4SBW-24S15	9-36 VDC	15 VDC	0 mA	1330 mA	10 mA	936 mA	88	1300µF
EC4SBW-24D12	9-36 VDC	±12 VDC	0 mA	±830 mA	10 mA	936 mA	87	800µF
EC4SBW-24D15	9-36 VDC	±15 VDC	0 mA	±660 mA	10 mA	936 mA	87	650µF
EC4SBW-48S33	18-75 VDC	3.3 VDC	0 mA	4500 mA	8 mA	390 mA	87	5000µF
EC4SBW-48S05	18-75 VDC	5 VDC	0 mA	4000 mA	8 mA	463 mA	89	4000µF
EC4SBW-48S12	18-75 VDC	12 VDC	0 mA	1670 mA	8 mA	463 mA	88	1650µF
EC4SBW-48S15	18-75 VDC	15 VDC	0 mA	1330 mA	8 mA	468 mA	88	1300µF
EC4SBW-48D12	18-75 VDC	±12 VDC	0 mA	±830 mA	8 mA	473 mA	87	800µF
EC4SBW-48D15	18-75 VDC	±15 VDC	0 mA	±660 mA	8 mA	468 mA	88	650µF

Derating Curve

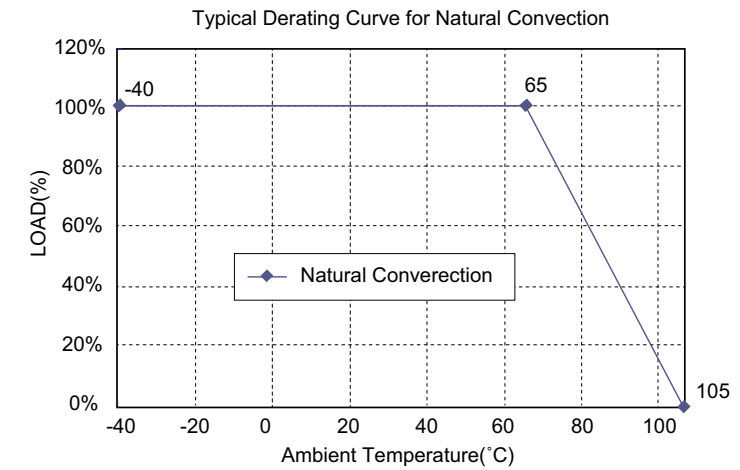

Specifications

All Specifications Typical At Nominal Line, Full Load, and 25°C Unless Otherwise Noted

INPUT SPECIFICATIONS

Input Voltage Range	24V 9-36V
	48V 18-75V
Input Surge Voltage (100ms max.)	24V 50Vdc max.
	48V 100Vdc max.
Under Voltage Lockout	24Vin
	power up 8.8V typ.
	power down 8.0V typ.
	48Vin
	power up 17V typ.
	power down 16V typ.
Input Filter	Pi Type
Positive Logic Remote On/Off Control (note 4):	
Logic Compatibility	CMOS or Open Collector TTL, ref. to -Vin
	Module On >+3.5 to 75VDC or Open Circuit
	Module Off <1.2VDC

OUTPUT SPECIFICATIONS

Voltage Accuracy	±1.5% max.
Voltage Balance (Dual)	±1.5% max.
Transient Response: 75% - 100% Step Load Change.	
Error Band	±5% Vout nominal
Recovery Time	< 250µs
Ripple & Noise, 20MHz BW (note3)	
Vo=3.3 & 5V	75mVpk-pk max.
Vo=12 & 15V	100mVpk-pk max.
Temperature Coefficient	±0.03%/°C
Short Circuit Protection	Continuous
Line Regulation (note 1)	Single ±0.2% max.
	Dual ±0.5% max.
Load Regulation (note 2)	Single ±0.2% max.
	Dual ±1.0% max.
Over Voltage Protection	Zener or TVS Clamp
External Trim Adj. Range (single output models only)	±10%
Current Limit	110% - 170% Nominal Output
Start up time	20ms max.

GENERAL SPECIFICATIONS

Efficiency	See Table
Isolation Voltage	1500 VDC min.
Isolation Resistance	10 ⁹ ohms min.
Isolation Capacitance	1500pF typ.
Switching Frequency	Vo=3.3 & 5V 270KHz typ.
	Others 330KHz typ.
Operating Ambient Temperature Range	-40°C to +85°C
Derating, Above 65°C	Linearly to Zero Power at +105°C
Case Temperature (note 5)	105°C
Cooling	Natural Convection
Storage Temperature Range	-55°C to +125°C
Humidity	95% RH max. Non condensing
Dimensions	1.00 x 1.00 x 0.40 inches (25.4 x 25.4 x 10.2 mm)
Case Material	Black Coated Copper with Non-Conductive Base
Weight	18 g

NOTE

1. Measured from high line to low line.
2. Measured from full load to min. load.
3. The output ripple and noise is measured with 10µF tantalum and 1µF ceramic capacitor across output.
4. Suffix "N" to the model number with negative logic remote On/Off
 Module On <1.2VDC
 Module Off >3.5VDC to 75VDC or open circuit
5. Maximum case temperature under any operating condition should not be exceeded 105°C.

EC5SBW SERIES

30 WATT, 4:1 INPUT RANGE

Visit www.cincon.com for new releases and a wider selection of products

Features

- ◆ 30W Isolated Output
- ◆ 1" x 1" x 0.4" Shielded Metal Case
- ◆ Very High Efficiency Up to 90%
- ◆ Low No Load Power Consumption
- ◆ 4 : 1 Input Range
- ◆ Regulated Outputs
- ◆ Fixed Switching Frequency
- ◆ Input Under Voltage Protection
- ◆ Over Current Protection
- ◆ Remote On/Off
- ◆ Continuous Short Circuit Protection
- ◆ Without Tantalum Capacitors Inside
- ◆ CE Mark Meets 2004/108/EC
- ◆ Safety Meets UL60950-1, EN60950-1, and IEC60950-1

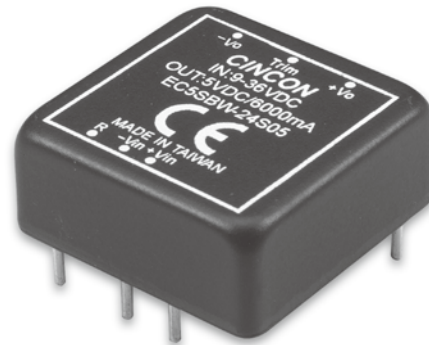

Mechanical Dimensions

All Dimensions in Inches (mm)
 Tolerance Inches: X.XX=±0.04, X.XXX=±0.010
 Millimeters: X.X=±0.5, X.XX=±0.25

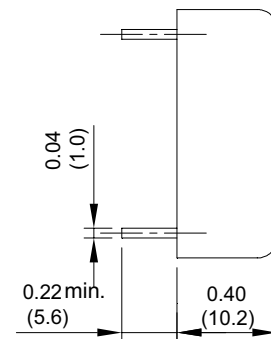
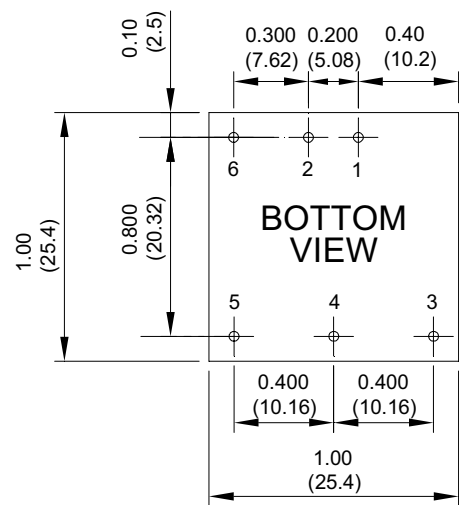

PIN CONNECTION		
PIN	DIP Function	
	Single Output	Dual Output
1	+Input	+Input
2	-Input	-Input
3	+V Output	+V Output
4	Trim	Common
5	-V Output	-V Output
6	Remote	Remote

MODEL NUMBER	INPUT VOLTAGE	OUTPUT VOLTAGE	OUTPUT CURRENT		INPUT CURRENT		% EFF.	CAPACITOR LOAD MAX.
			MIN.	MAX.	NO LOAD	FULL LOAD		
EC5SBW-24S33	9-36 VDC	3.3 VDC	0 mA	7500 mA	10 mA	1172 mA	88	7500µF
EC5SBW-24S05	9-36 VDC	5 VDC	0 mA	6000 mA	10 mA	1389 mA	90	6000µF
EC5SBW-24S12	9-36 VDC	12 VDC	0 mA	2500 mA	10 mA	1404 mA	89	2500µF
EC5SBW-24S15	9-36 VDC	15 VDC	0 mA	2000 mA	10 mA	1404 mA	89	2000µF
EC5SBW-24D12	9-36 VDC	±12 VDC	0 mA	±1250 mA	10 mA	1404 mA	88	1250µF
EC5SBW-24D15	9-36 VDC	±15 VDC	0 mA	±1000 mA	10 mA	1404 mA	88	1000µF
EC5SBW-48S33	18-75 VDC	3.3 VDC	0 mA	7500 mA	8 mA	586 mA	88	7500µF
EC5SBW-48S05	18-75 VDC	5 VDC	0 mA	6000 mA	8 mA	694 mA	90	6000µF
EC5SBW-48S12	18-75 VDC	12 VDC	0 mA	2500 mA	8 mA	694 mA	89	2500µF
EC5SBW-48S15	18-75 VDC	15 VDC	0 mA	2000 mA	8 mA	702 mA	89	2000µF
EC5SBW-48D12	18-75 VDC	±12 VDC	0 mA	±1250 mA	8 mA	710 mA	88	1250µF
EC5SBW-48D15	18-75 VDC	±15 VDC	0 mA	±1000 mA	8 mA	702 mA	89	1000µF

Derating Curve

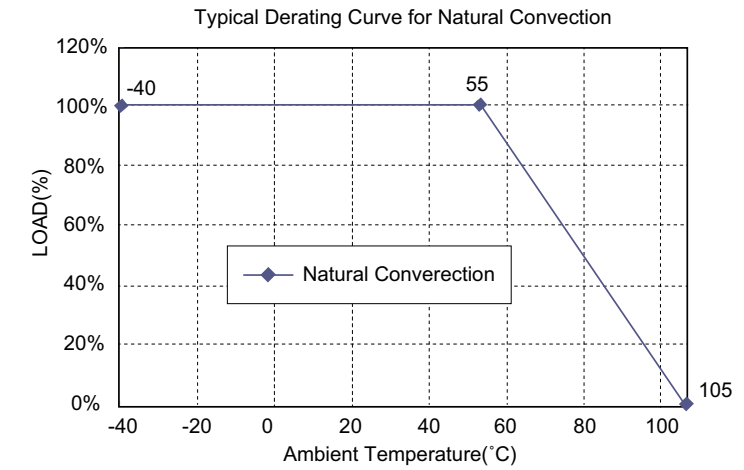

Specifications

All Specifications Typical At Nominal Line, Full Load, and 25°C Unless Otherwise Noted

INPUT SPECIFICATIONS

Input Voltage Range	24V 9-36V 48V 18-75V
Input Surge Voltage (100ms max.)	24V 50Vdc max. 48V 100Vdc max.
Under Voltage Lockout	24V _{in} power up 8.8V typ. power down 8.0V typ. 48V _{in} power up 17V typ. power down 16V typ.
Input Filter	PI Type
Positive Logic Remote On/Off Control (note 4):	CMOS or Open Collector TTL, ref. to -V _{in}
Logic Compatibility	>+3.5 to 75VDC or Open Circuit < 1.2VDC
Module On	
Module Off	

OUTPUT SPECIFICATIONS

Voltage Accuracy	±1.5% max.
Voltage Balance (Dual)	±1.5% max.
Transient Response: 75% - 100% Step Load Change.	
Error Band	±5% V _{out} nominal
Recovery Time	< 250µs
Ripple & Noise, 20MHz BW (note 3)	
Vo=3.3 & 5V	75mVpk-pk max.
Vo=12 & 15V	100mVpk-pk max.
Temperature Coefficient	±0.03%/°C
Short Circuit Protection	Continuous
Line Regulation (note 1)	±0.2% max.
	Dual ±0.5% max.
Load Regulation (note 2)	±0.2% max.
	Dual ±1.0% max.
Over Voltage Protection	Zener or TVS Clamp
External Trim Adj. Range (single output models only)	±10%
Current Limit	110% - 170% Nominal Output
Start up time	20ms max.

GENERAL SPECIFICATIONS

Efficiency	See Table
Isolation Voltage	1500 VDC min.
Isolation Resistance	10 ⁹ ohms min.
Isolation Capacitance	1500pF typ.
Switching Frequency	Vo=3.3 & 5V 270KHz typ. Others 330KHz typ.
Operating Ambient Temperature Range	-40°C to +85°C
Derating, Above 55°C	Linearly to Zero Power at +105°C
Case Temperature (note 5)	105°C
Cooling	Natural Convection
Storage Temperature Range	-55°C to +125°C
Thermal Shutdown Case Temp	110°C typ.
Humidity	95% RH max. Non condensing
Dimensions	1.00 x 1.00 x 0.40 inches (25.4 x 25.4 x 10.2 mm)
Case Material	Black Coated Copper with Non-Conductive Base
Weight	18 g

NOTE

1. Measured from high line to low line.
2. Measured from full load to min. load.
3. The output ripple and noise is measured with 10µF tantalum and 1µF ceramic capacitor across output.
4. Suffix "N" to the model number with negative logic remote On/Off
 Module On <1.2VDC
 Module Off >3.5VDC to 75VDC or open circuit
5. Maximum case temperature under any operating condition should not be exceeded 105°C.

EC3B SERIES

7.5 WATT, 2:1 INPUT RANGE

Visit www.cincon.com for new releases and a wider selection of products

Features

- ◆ 7.5W Isolated Output
- ◆ Efficiency to 82%
- ◆ 2" x 1" Case
- ◆ Regulated Outputs
- ◆ Pi Input Filter
- ◆ Continuous Short Circuit Protection

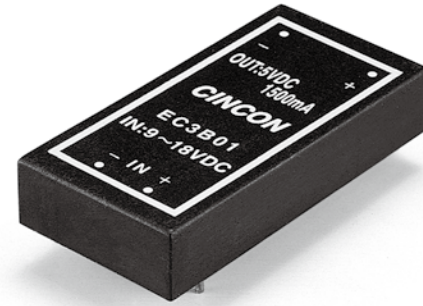

Not Recommended For New Designs

Mechanical Dimensions

All Dimensions in Inches (mm)
 Tolerance Inches: X.XX±0.04, X.XXX±0.010
 Millimeters: X.X±0.5, X.XX±0.25

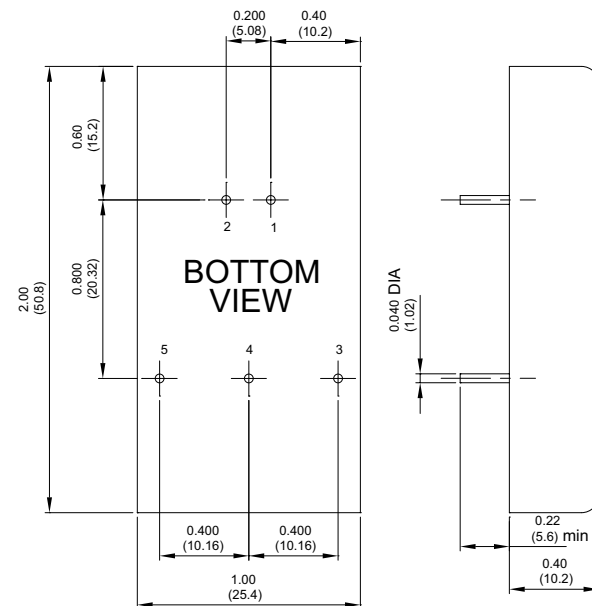

PIN CONNECTION	
Pin	Function
1	+Input
2	-Input
3	+Output
4	Common/NP
5	-Output

* NP-NO PIN ON SINGLE OUTPUT

Derating Curve

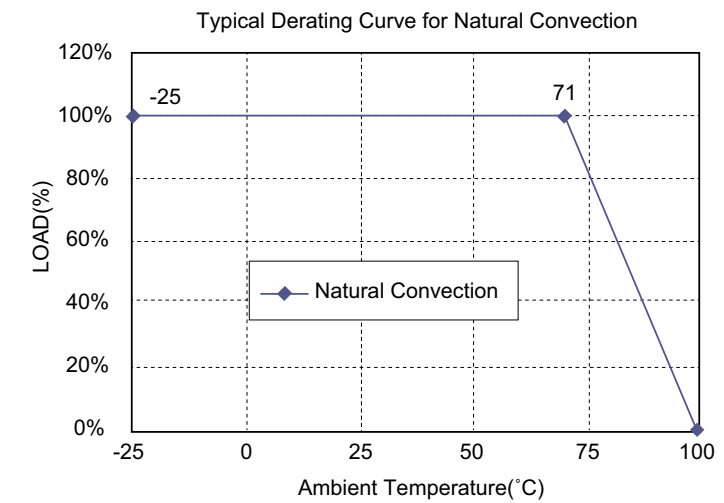

Specifications

All Specifications Typical At Nominal Line, Full Load, and 25°C Unless Otherwise Noted

INPUT SPECIFICATIONS

Input Voltage Range	12V..... 9-18V 24V 18-36V 48V 36-72V
Input Filter	Pi Type

OUTPUT SPECIFICATIONS

Voltage Accuracy	±2.0% max.
Voltage Balance (Dual)	±1.0% max.
Temperature Coefficient	±0.05%/°C
Ripple & Noise, 20MHz BW	3.3V/5V.....100mV p-p max. 12V/15V.....1%p-p max.
Short Circuit Protection	Continuous
Line Regulation Single/Dual (note 1)	±0.5% max.
Load Regulation Single (note 2)	±0.5% max.
Dual (note 3)	±1.0% max.

GENERAL SPECIFICATIONS

Efficiency	See Table
Isolation Voltage	1500 VDC min.
Isolation Resistance	10 ⁹ ohms
Switching Frequency	100KHz min.
Operating Ambient Temperature Range	-25°C to +71°C
De-rating, Above 71°C	Linearly to Zero power at 100°C
Case Temperature (note 4)	100°C max.
Cooling	Natural Convection
Storage Temperature Range	-40°C to +100°C
Dimensions	2.00 x 1.00 x 0.40 inches (50.8 x 25.4 x 10.2mm)
Case Material	Black Coated Copper With Non-Conductive Base
Weight	35 g

NOTE

1. Measured from high line to low line.
2. Measured from full load to 10% load.
3. Measured from full load to 1/4 load.
4. Maximum case temperature under any operating condition should not be exceeded 100°C.

MODEL NUMBER	INPUT VOLTAGE	OUTPUT VOLTAGE	OUTPUT CURRENT	INPUT CURRENT		% EFF.
				NO LOAD	FULL LOAD	
EC3B01	9-18 VDC	5 VDC	1500 mA	7.5 mA	820 mA	76
EC3B02	9-18 VDC	12 VDC	625 mA	7.5 mA	780 mA	80
EC3B03	9-18 VDC	15 VDC	500 mA	7.5 mA	780 mA	80
EC3B04	9-18 VDC	±12 VDC	±310 mA	12 mA	775 mA	80
EC3B05	9-18 VDC	±15 VDC	±250 mA	12 mA	780 mA	80
EC3B06	9-18 VDC	±5 VDC	±750 mA	7.5 mA	820 mA	76
EC3B07	9-18 VDC	3.3 VDC	1500 mA	7.5 mA	557 mA	74
EC3B11	18-36 VDC	5 VDC	1500 mA	5 mA	400 mA	78
EC3B12	18-36 VDC	12 VDC	625 mA	5 mA	380 mA	82
EC3B13	18-36 VDC	15 VDC	500 mA	5 mA	380 mA	82
EC3B14	18-36 VDC	±12 VDC	±310 mA	7.5 mA	385 mA	81
EC3B15	18-36 VDC	±15 VDC	±250 mA	7.5 mA	385 mA	81
EC3B16	18-36 VDC	±5 VDC	±750 mA	7.5 mA	400 mA	78
EC3B17	18-36 VDC	3.3 VDC	1500 mA	5 mA	271 mA	76
EC3B21	36-72 VDC	5 VDC	1500 mA	2 mA	200 mA	78
EC3B22	36-72 VDC	12 VDC	625 mA	2 mA	192 mA	81
EC3B23	36-72 VDC	15 VDC	500 mA	2 mA	192 mA	81
EC3B24	36-72 VDC	±12 VDC	±310 mA	3 mA	192 mA	81
EC3B25	36-72 VDC	±15 VDC	±250 mA	3 mA	192 mA	81
EC3B26	36-72 VDC	±5 VDC	±750 mA	3 mA	200 mA	78
EC3B27	36-72 VDC	3.3 VDC	1500 mA	3 mA	36 mA	76

EC3BB SERIES

7.5 WATT, 2:1 INPUT RANGE

Visit www.cincon.com for new releases and a wider selection of products

Features

- ◆ 7.5W Isolated Output
- ◆ Remote On/Off (Option)
- ◆ Efficiency to 82%
- ◆ 2" x 1" Case
- ◆ Regulated Outputs
- ◆ Continuous Short Circuit Protection
- ◆ Meets EN55022 Class B, Conducted
- ◆ Pi Input Filter



Mechanical Dimensions

All Dimensions in Inches (mm)
 Tolerance Inches: X.XX=±0.04, X.XXX=±0.010
 Millimeters: X.X=±0.5, X.XX=±0.25

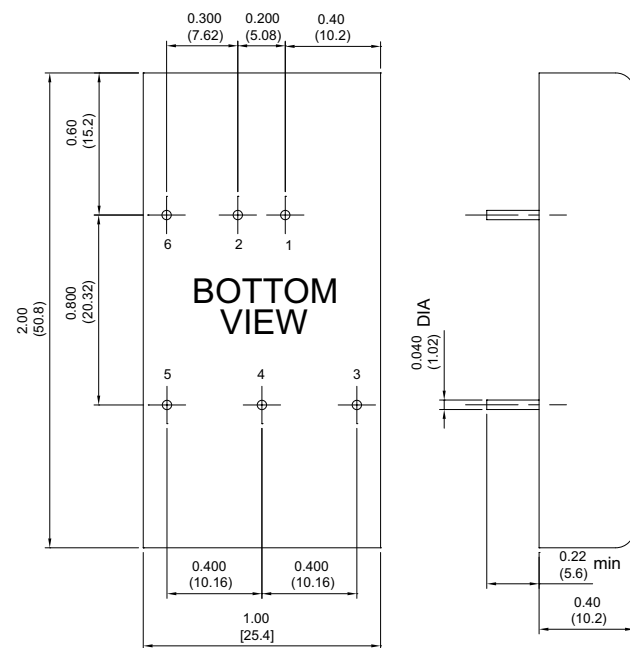

PIN CONNECTION	
Pin	Function
1	+Input
2	-Input
3	+Output
4	Common/NP
5	-Output
6	NP(Remote On/Off)

* NP-NO PIN ON SINGLE OUTPUT

MODEL NUMBER	INPUT VOLTAGE	OUTPUT VOLTAGE	OUTPUT CURRENT	INPUT CURRENT		% EFF.
				NO LOAD	FULL LOAD	
EC3BB01	9-18 VDC	5 VDC	1500 mA	7.5 mA	820 mA	76
EC3BB02	9-18 VDC	12 VDC	625 mA	7.5 mA	780 mA	80
EC3BB03	9-18 VDC	15 VDC	500 mA	7.5 mA	780 mA	80
EC3BB04	9-18 VDC	±12 VDC	±310 mA	12 mA	775 mA	80
EC3BB05	9-18 VDC	±15 VDC	±250 mA	12 mA	780 mA	80
EC3BB06	9-18 VDC	±5 VDC	±750 mA	7.5 mA	820 mA	76
EC3BB07	9-18 VDC	3.3 VDC	1500 mA	7.5 mA	557 mA	74
EC3BB11	18-36 VDC	5 VDC	1500 mA	5 mA	400 mA	78
EC3BB12	18-36 VDC	12 VDC	625 mA	5 mA	380 mA	82
EC3BB13	18-36 VDC	15 VDC	500 mA	5 mA	380 mA	82
EC3BB14	18-36 VDC	±12 VDC	±310 mA	7.5 mA	385 mA	81
EC3BB15	18-36 VDC	±15 VDC	±250 mA	7.5 mA	385 mA	81
EC3BB16	18-36 VDC	±5 VDC	±750 mA	7.5 mA	400 mA	78
EC3BB17	18-36 VDC	3.3 VDC	1500 mA	5 mA	271 mA	76
EC3BB21	36-72 VDC	5 VDC	1500 mA	2 mA	200 mA	78
EC3BB22	36-72 VDC	12 VDC	625 mA	2 mA	192 mA	81
EC3BB23	36-72 VDC	15 VDC	500 mA	2 mA	192 mA	81
EC3BB24	36-72 VDC	±12 VDC	±310 mA	3 mA	192 mA	81
EC3BB25	36-72 VDC	±15 VDC	±250 mA	3 mA	192 mA	81
EC3BB26	36-72 VDC	±5 VDC	±750 mA	3 mA	200 mA	78
EC3BB27	36-72 VDC	3.3 VDC	1500 mA	3 mA	36 mA	76

Derating Curve

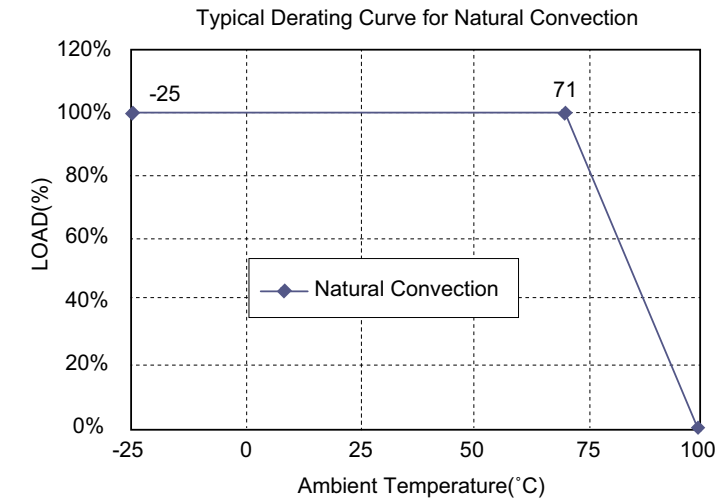

Specifications

All Specifications Typical At Nominal Line, Full Load, and 25°C Unless Otherwise Noted

INPUT SPECIFICATIONS

Input Voltage Range	12V..... 9-18V 24V 18-36V 48V 36-72V
Input Filter	Pi Type

OUTPUT SPECIFICATIONS

Voltage Accuracy	±2.0% max.
Voltage Balance (Dual)	±1.0% max.
Temperature Coefficient	±0.05%/°C
Ripple & Noise, 20MHz BW	3.3V/5V.....100mV p-p max. 12V/15V.....1%p-p max.
Short Circuit Protection	Continuous
Line Regulation Single/Dual (note 1)	±0.5% max.
Load Regulation Single (note 2)	±0.5% max.
Dual (note 3)	±1.0% max.

GENERAL SPECIFICATIONS

Efficiency	See Table
Isolation Voltage	1500 VDC min.
Isolation Resistance	10 ⁹ ohms
Switching Frequency	100KHz min.
Operating Ambient Temperature Range	-25°C to +71°C
De-rating, Above 71°C	Linearly to Zero power at 100°C
Case Temperature (note 4)	100°C max.
Cooling	Natural Convection
Storage Temperature Range	-40°C to +100°C
EMI/RFI	Conductive EMI Meet EN55022 Class B
Dimensions	2.00 x 1.00 x 0.40 inches (50.8 x 25.4 x 10.2mm)
Case Material	Black Coated Copper With Non-Conductive Base
Weight	32.5 g

NOTE

1. Measured from high line to low line.
2. Measured from full load to 10% load.
3. Measured from full load to 1/4 load.
4. Suffix "T" to the model number with remote On/Off

Module On	>5.5VDC or open circuit
Module Off	<1.8VDC
Shutdown idle	10mA
Control common	referenced to input minus
5. Maximum case temperature under any operating condition should not be exceeded 100°C.

EC4B SERIES

10 WATT, 2:1 INPUT RANGE

Visit www.cincon.com for new releases and a wider selection of products

Features

- ◆ 10W Isolated Output
- ◆ 2" x 1" Six-Sided Shield Metal Case
- ◆ Efficiency to 82%
- ◆ 2 : 1 Input Range
- ◆ Pi Input Filter
- ◆ Continuous Short Circuit Protection
- ◆ Meets EN55022 Class A, Conducted

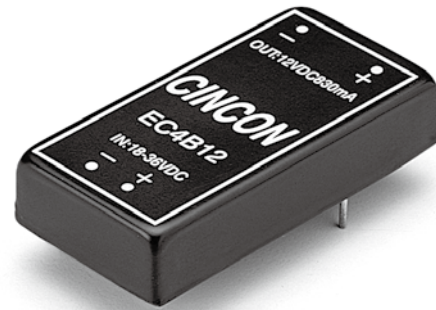

Not Recommended For New Designs

Mechanical Dimensions

All Dimensions in Inches (mm)
Tolerance Inches: X.XX=±0.04, X.XXX=±0.010
Millimeters: X.X=±0.5, X.XX=±0.25

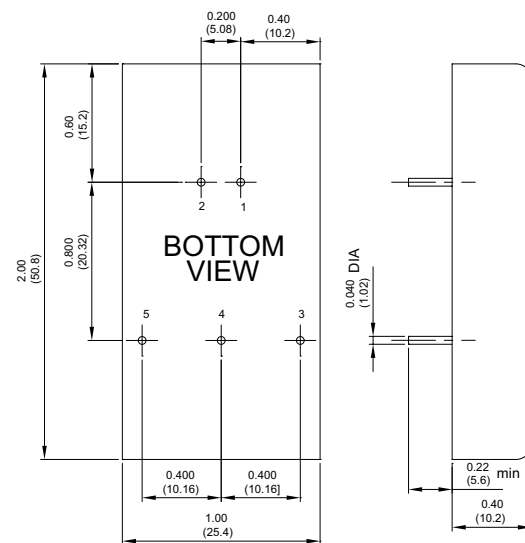

PIN CONNECTION	
Pin	Function
1	+Input
2	-Input
3	+Output
4	Common/NP
5	-Output

* NP-NO PIN ON SINGLE OUTPUT

MODEL NUMBER	INPUT VOLTAGE	OUTPUT VOLTAGE	OUTPUT CURRENT		INPUT CURRENT		% EFF.
			MIN.	MAX.	NO LOAD	FULL LOAD	
EC4B01	9-18 VDC	5 VDC	100 mA	2000 mA	30 mA	1100 mA	76
EC4B02	9-18 VDC	12 VDC	45 mA	830 mA	30 mA	1065 mA	78
EC4B03	9-18 VDC	15 VDC	35 mA	666 mA	30 mA	1065 mA	78
EC4B04	9-18 VDC	±12 VDC	±25 mA	±415 mA	40 mA	1065 mA	78
EC4B05	9-18 VDC	±15 VDC	±20 mA	±333 mA	40 mA	1065 mA	78
EC4B06	9-18 VDC	±5 VDC	±50 mA	±1000 mA	40 mA	1065 mA	78
EC4B11	18-36 VDC	5 VDC	100 mA	2000 mA	20 mA	535 mA	78
EC4B12	18-36 VDC	12 VDC	45 mA	830 mA	20 mA	520 mA	80
EC4B13	18-36 VDC	15 VDC	35 mA	666 mA	20 mA	520 mA	80
EC4B14	18-36 VDC	±12 VDC	±25 mA	±415 mA	20 mA	520 mA	80
EC4B15	18-36 VDC	±15 VDC	±20 mA	±333 mA	20 mA	520 mA	80
EC4B16	18-36 VDC	±5 VDC	±50 mA	±1000 mA	20 mA	520 mA	80
EC4B21	36-72 VDC	5 VDC	100 mA	2000 mA	10 mA	260 mA	80
EC4B22	36-72 VDC	12 VDC	45 mA	830 mA	10 mA	254 mA	82
EC4B23	36-72 VDC	15 VDC	35 mA	666 mA	10 mA	254 mA	82
EC4B24	36-72 VDC	±12 VDC	±25 mA	±415 mA	10 mA	254 mA	82
EC4B25	36-72 VDC	±15 VDC	±20 mA	±333 mA	10 mA	254 mA	82
EC4B26	36-72 VDC	±5 VDC	±50 mA	±1000 mA	10 mA	254 mA	82
EC4B31	4.7-9 VDC	5 VDC	0 mA	1600 mA	15 mA	2130 mA	75
EC4B32	4.7-9 VDC	12 VDC	0 mA	666 mA	15 mA	2100 mA	76
EC4B33	4.7-9 VDC	15 VDC	0 mA	533 mA	15 mA	2100 mA	76
EC4B34	4.7-9 VDC	±12 VDC	0 mA	±333 mA	15 mA	2100 mA	76
EC4B35	4.7-9 VDC	±15 VDC	0 mA	±266 mA	15 mA	2100 mA	76
EC4B36	4.7-9 VDC	±5 VDC	0 mA	±800 mA	15 mA	2100 mA	76

Derating Curve

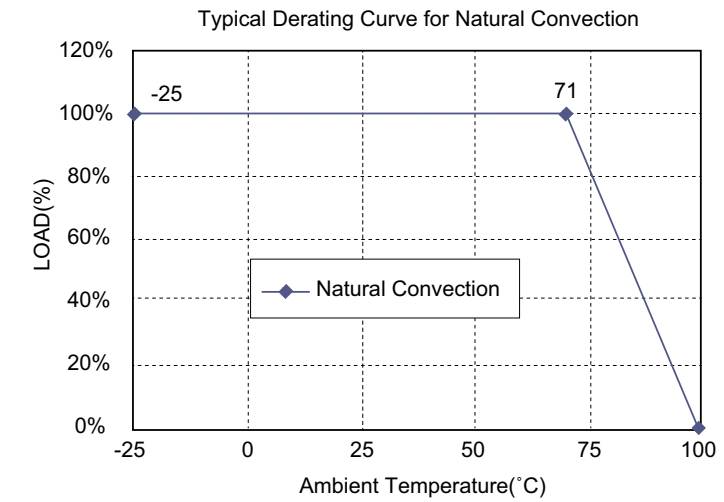

Specifications

All Specifications Typical At Nominal Line, Full Load, and 25°C Unless Otherwise Noted

INPUT SPECIFICATIONS

Input Voltage Range	4.7-9V 9-18V 18-36V 36-72V
Input Surge Voltage (100ms max.)	15Vdc max. 25Vdc max. 50Vdc max. 100Vdc max.
Input Filter	Pi Type

OUTPUT SPECIFICATIONS

Voltage Accuracy	±1.0% max.
Voltage Balance (Dual)	±1.0% max.
Transient Response	< 500µs
Single 25% Step Load Change	< 500µs
Dual FL-1/2L±1% Error Band	< 500µs
Ripple and Noise, 20MHz BW	100mV p-p max.
Temperature Coefficient	±0.02%/°C max.
Short Circuit Protection	Continuous
Line Regulation (note 1), Single/Dual Output	±0.2% max.
Load Regulation (note 2), Single/Dual Output	±1.0% max.
Start up time	5Vin, 12Vin 145ms Typ. 24Vin 70ms Typ. 48Vin 6ms Typ.

GENERAL SPECIFICATIONS

Efficiency	See Table
Isolation Voltage	500 VDC min
Isolation Resistance	10 ⁹ ohms
Isolation Capacitance	2500pF Typ.
Switching Frequency	200KHz, min.
Operating Ambient Temperature Range	-25°C to +71°C
De-rating, Above 71°C	Linearly to Zero power at 100°C
Case Temperature (note 4)	100°C max.
Cooling	Natural Convection
Storage Temperature Range	-40°C to +100°C
Humidity	95% RH max. Non condensing
MTBF.....MIL-STD-217F, GB, 25°C, Full Load	1500K hrs Typ.
EMI/RFI	Six sided Continuous Shield
Dimensions	2.00 x 1.00 x 0.40 inches (50.8 x 25.4 x 10.2mm)
Case Material	Black Coated Copper with Non-Conductive Base
Weight	35 g

NOTE

1. Measured from high line to low line.
2. Measured from full load to 1/4 load.
3. A minimum load on the output is necessary to maintain regulation
4. Maximum case temperature under any operating condition should not be exceeded 100°C.

EC4BE SERIES

10 WATT, 2:1 INPUT RANGE

Visit www.cincon.com for new releases and a wider selection of products

Features

- ◆ 10W Isolated Output
- ◆ 2" x 1" Six-Sided Shield Metal Case
- ◆ Efficiency to 82%
- ◆ 2 : 1 Input Range
- ◆ Pi Input Filter
- ◆ Continuous Short Circuit Protection
- ◆ Meets EN55022 Class A, Conducted
- ◆ UL60950-1 Approval

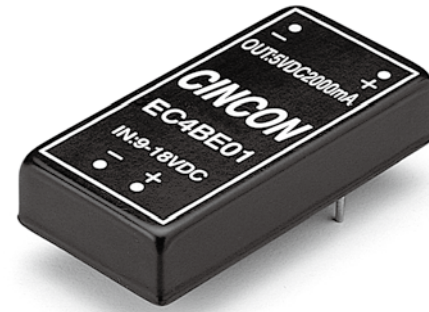

Mechanical Dimensions

NOTE: Pin Size is 0.04±0.004 Inch (1.0±0.1 mm)DIA
All Dimensions in Inches (mm)
Tolerance Inches: X.XX=±0.04, X.XXX=±0.010
Millimeters: X.X=±0.5, X.XX=±0.25

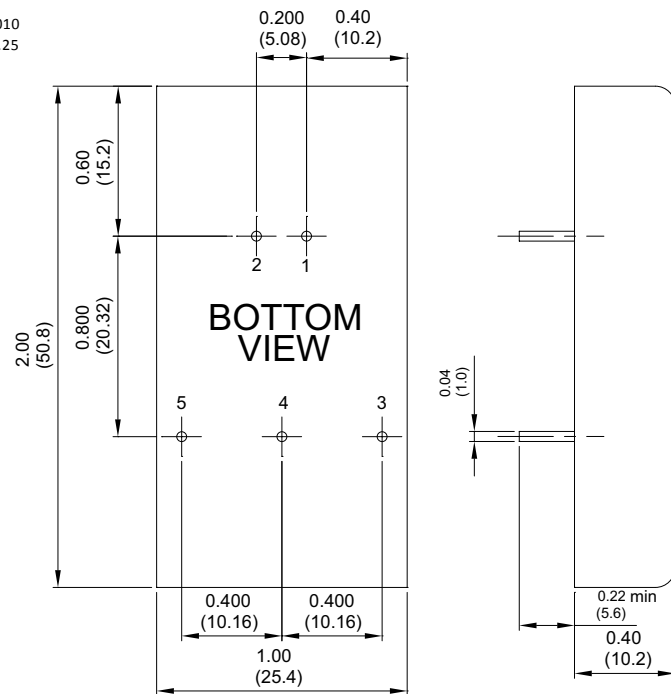

PIN CONNECTION	
Pin	Function
1	+Input
2	-Input
3	+Output
4	Common/NP
5	-Output

* NP-NO PIN ON SINGLE OUTPUT

MODEL NUMBER	INPUT VOLTAGE	OUTPUT VOLTAGE	OUTPUT CURRENT		INPUT CURRENT		% EFF.	CAPACITOR LOAD MAX.
			MIN.	MAX.	NO LOAD	FULL LOAD		
EC4BE01	9-18 VDC	5 VDC	100 mA	2000 mA	30 mA	1100 mA	76	2000µF
EC4BE02	9-18 VDC	12 VDC	45 mA	830 mA	30 mA	1065 mA	78	830µF
EC4BE03	9-18 VDC	15 VDC	35 mA	666 mA	30 mA	1065 mA	78	666µF
EC4BE04	9-18 VDC	±12 VDC	±25 mA	±415 mA	40 mA	1065 mA	78	415µF
EC4BE05	9-18 VDC	±15 VDC	±20 mA	±333 mA	40 mA	1065 mA	78	333µF
EC4BE06	9-18 VDC	±5 VDC	±50 mA	±1000 mA	40 mA	1065 mA	78	1000µF
EC4BE11	18-36 VDC	5 VDC	100 mA	2000 mA	20 mA	535 mA	78	2000µF
EC4BE12	18-36 VDC	12 VDC	45 mA	830 mA	20 mA	520 mA	80	830µF
EC4BE13	18-36 VDC	15 VDC	35 mA	666 mA	20 mA	520 mA	80	666µF
EC4BE14	18-36 VDC	±12 VDC	±25 mA	±415 mA	20 mA	520 mA	80	415µF
EC4BE15	18-36 VDC	±15 VDC	±20 mA	±333 mA	20 mA	520 mA	80	333µF
EC4BE16	18-36 VDC	±5 VDC	±50 mA	±1000 mA	20 mA	520 mA	80	1000µF
EC4BE21	36-72 VDC	5 VDC	100 mA	2000 mA	10 mA	260 mA	80	2000µF
EC4BE22	36-72 VDC	12 VDC	45 mA	830 mA	10 mA	254 mA	82	830µF
EC4BE23	36-72 VDC	15 VDC	35 mA	666 mA	10 mA	254 mA	82	666µF
EC4BE24	36-72 VDC	±12 VDC	±25 mA	±415 mA	10 mA	254 mA	82	415µF
EC4BE25	36-72 VDC	±15 VDC	±20 mA	±333 mA	10 mA	254 mA	82	333µF
EC4BE26	36-72 VDC	±5 VDC	±50 mA	±1000 mA	10 mA	254 mA	82	1000µF

Derating Curve

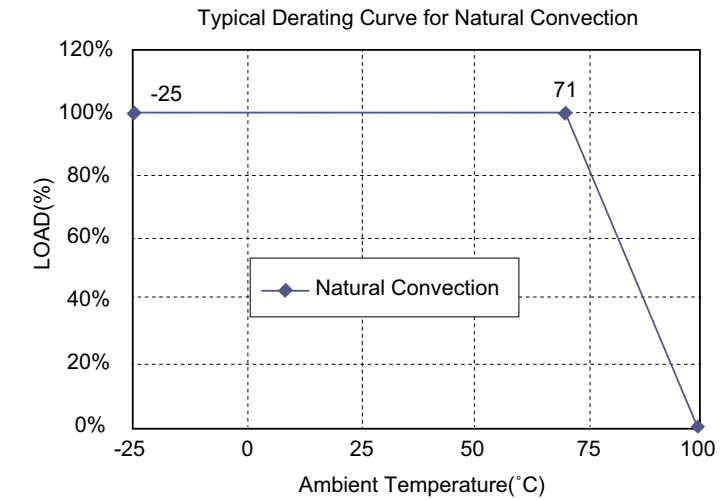

Specifications

All Specifications Typical At Nominal Line, Full Load, and 25°C Unless Otherwise Noted

INPUT SPECIFICATIONS

Input Voltage Range	12V9-18V 24V 18-36V 48V 36-72V
Input Surge Voltage (100ms max.)	12V 25Vdc max. 24V 50Vdc max. 48V 100Vdc max.
Input Filter	Pi Type

OUTPUT SPECIFICATIONS

Voltage Accuracy	±1.0% max.
Voltage Balance (Dual)	±1.0% max.
Transient Response	
Single 25% Step Load Change	< 500µs
Dual FL-1/2L±1% Error Band	< 500µs
Ripple and Noise, 20MHz BW	100mV pk-pk max.
Temperature Coefficient	±0.02%/°C
Short Circuit Protection	Continuous
Line Regulation (note 1)	±0.2% max.
Load Regulation (note 2)	±1.0% max.
Start up time	12Vin, 24Vin 60ms typ. 48Vin 28ms typ.

GENERAL SPECIFICATIONS

Efficiency	See Table
Isolation Voltage	500 VDC min
Isolation Resistance	10 ⁹ ohm min.
Isolation Capacitance	2500pF typ.
Switching Frequency	200KHz min.
Operating Ambient Temperature Range	-25°C to +71°C
De-rating, Above 71°C	Linearly to Zero power at 100°C
Case Temperature (note 4)	100°C max.
Cooling	Natural Convection
Storage Temperature Range	-40°C to +100°C
Humidity	95% RH max. Non condensing
MTBF MIL-STD-217F, GB, 25°C, Full Load	1400Khrs typ.
EMI/RFI	Six sided Continuous Shield
Dimensions	2.00 x 1.00 x 0.40 inches (50.8 x 25.4 x 10.2 mm)
Case Material	Black Coated Copper with Non-Conductive Base
Weight	33 g

NOTE

1. Measured from high line to low line.
2. Measured from full load to 1/4 load.
3. A minimum load on the output is necessary to maintain regulation.
4. Maximum case temperature under any operating condition should not be exceeded 100°C.

EC4BW SERIES

10 WATT, 4:1 INPUT RANGE

Visit www.cincon.com for new releases and a wider selection of products

Features

- ◆ 10W Isolated Output
- ◆ 2" x 1" Six-Sided Shield Metal Case
- ◆ Efficiency to 82%
- ◆ 4 : 1 Input Range
- ◆ Pi Input Filter
- ◆ Continuous Short Circuit Protection
- ◆ Meets EN55022 Class A, Conducted



Mechanical Dimensions

All Dimensions in Inches (mm)
 Tolerance Inches: X.XX=±0.04, X.XXX=±0.010
 Millimeters: X.X=±0.5, X.XX=±0.25

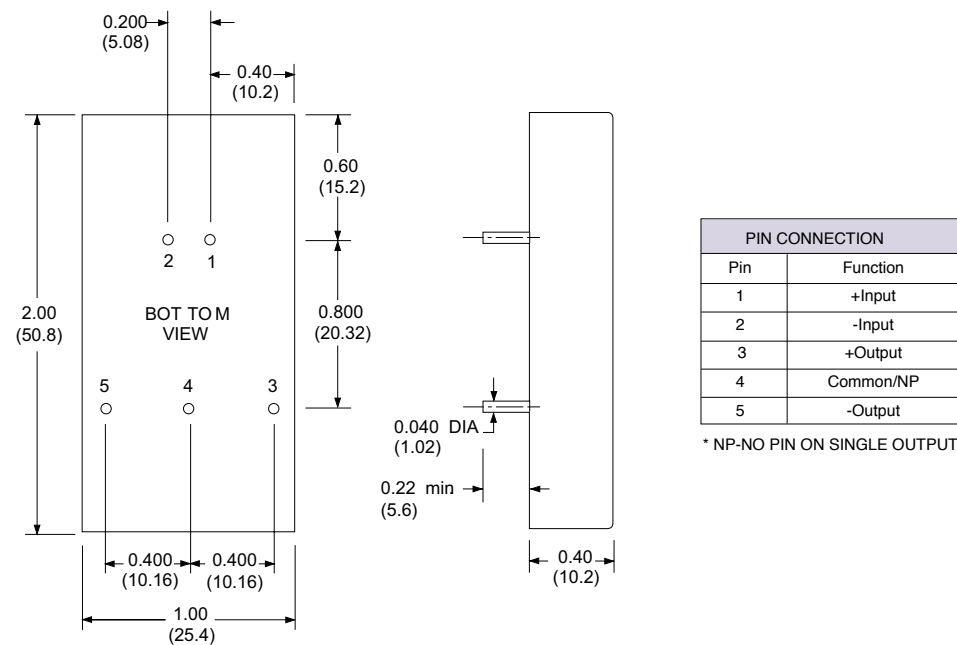

MODEL NUMBER	INPUT VOLTAGE	OUTPUT VOLTAGE	OUTPUT CURRENT	INPUT CURRENT		% EFF.
				NO LOAD	FULL LOAD	
EC4BW01	9-36 VDC	5 VDC	2000 mA	15 mA	534 mA	78
EC4BW02	9-36 VDC	12 VDC	830 mA	15 mA	520 mA	80
EC4BW03	9-36 VDC	15 VDC	666 mA	15 mA	520 mA	80
EC4BW04	9-36 VDC	±12 VDC	±415 mA	20 mA	520 mA	80
EC4BW05	9-36 VDC	±15 VDC	±333 mA	20 mA	520 mA	80
EC4BW06	9-36 VDC	±5 VDC	±1000 mA	20 mA	520 mA	80
EC4BW07	9-36 VDC	3.3 VDC	2000 mA	15 mA	362 mA	76
EC4BW11	18-72 VDC	5 VDC	2000 mA	10 mA	260 mA	80
EC4BW12	18-72 VDC	12 VDC	830 mA	10 mA	257 mA	81
EC4BW13	18-72 VDC	15 VDC	666 mA	10 mA	257 mA	81
EC4BW14	18-72 VDC	±12 VDC	±415 mA	15 mA	257 mA	81
EC4BW15	18-72 VDC	±15 VDC	±333 mA	15 mA	253 mA	82
EC4BW16	18-72 VDC	±5 VDC	±1000 mA	15 mA	253 mA	82
EC4BW17	18-72 VDC	3.3 VDC	2000 mA	10 mA	181 mA	76

Derating Curve

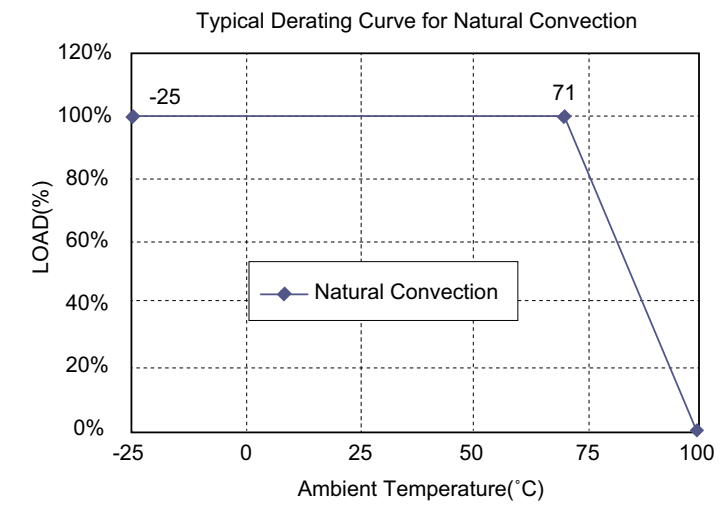

Specifications

All Specifications Typical At Nominal Line, Full Load, and 25°C Unless Otherwise Noted

INPUT SPECIFICATIONS

Input Voltage Range	24V 9-36V
	48V 18-72V
Input Surge Voltage (100ms max.)	24V 50Vdc max.
	48V 100Vdc max.
Input Filter	Pi Type

OUTPUT SPECIFICATIONS

Voltage Accuracy	±1.0% max.
Voltage Balance Dual Output at Full Load	±1.0% max.
Transient Response	
Single 25% Step Load Change	< 500µs
Dual FL-1/2L±1% Error Band	< 500µs
Ripple and Noise, 20MHz BW	75mV pk-pk max.
Temperature Coefficient	±0.02%/°C max.
Short Circuit Protection	Continuous
Line Regulation (note 1)	±0.2% max.
Load Regulation (note 2)	±1.0% max.
Start up time	24Vin 5ms typ.
	48Vin 10ms typ.

GENERAL SPECIFICATIONS

Efficiency	See Table
Isolation Voltage	500 VDC
Isolation Resistance	10 ⁹ ohm min.
Isolation Capacitance	500pF typ.
Switching Frequency	300KHz typ.
Operating Ambient Temperature Range	-25°C to +71°C
De-rating, Above 71°C	Linearly to Zero power at 100°C
Case Temperature (note 3)	100°C max.
Cooling	Natural Convection
Storage Temperature Range	-40°C to +100°C
Humidity	95% RH max. Non condensing
MTBF.....MIL-STD-217F, GB, 25°C, Full Load	750K hrs Typ.
EMI/RFI	Six sided Continuous Shield
Dimensions	2.00 x 1.00 x 0.40 inches (50.8 x 25.4 x 10.2 mm)
Case Material	Black Coated Copper with Non-Conductive Base
Weight	32 g

NOTE

1. Measured from high line to low line.
2. Measured from full load to 1/4 load.
3. Maximum case temperature under any operating condition should not be exceeded 100°C.

EC4BU SERIES

10 WATT, 2:1 INPUT RANGE

Visit www.cincon.com for new releases and a wider selection of products

Features

- ◆ 10W Isolated Output
- ◆ Efficiency to 87%
- ◆ 2 : 1 Input Range
- ◆ Regulated Outputs
- ◆ Fixed Switching Frequency
- ◆ Input Under Voltage Protection
- ◆ Over Current Protection
- ◆ Conductive EMI Meets EN55022 Class A
- ◆ Continuous Short Circuit Protection
- ◆ Without Tantalum Capacitors Inside
- ◆ CE Mark Meets 2004/108/EC
- ◆ Safety Meets UL60950-1, EN60950-1 and IEC60950-1

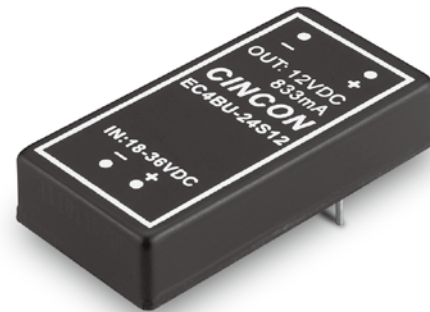

Mechanical Dimensions

NOTE: Pin Size is 0.04±0.004 Inch (1.0±0.1 mm)DIA
All Dimensions in Inches (mm)
Tolerance Inches: X.XX=±0.04, X.XXX=±0.010
Millimeters: X.X=±0.5, X.XX=±0.25

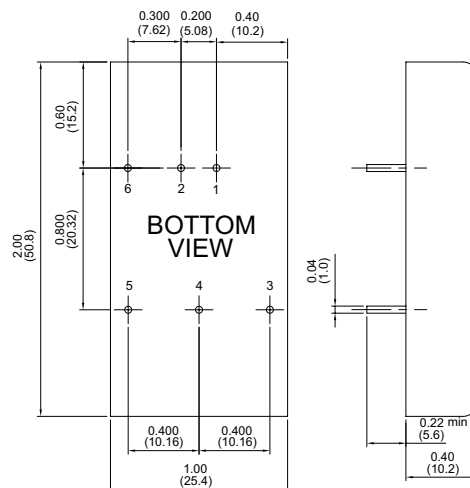

PIN CONNECTION	
Pin	Function
1	+Input
2	-Input
3	+V Output
4	Common/NP/Trim(Optional)
5	-V Output
6	NP/Remote(Optional)

* NP-NO PIN ON SINGLE OUTPUT

MODEL NUMBER	INPUT VOLTAGE	OUTPUT VOLTAGE	OUTPUT CURRENT		INPUT CURRENT		% EFF.	CAPACITOR LOAD MAX.
			MIN.	MAX.	NO LOAD	FULL LOAD		
EC4BU-05S33	4.7-9 VDC	3.3 VDC	0 mA	2500 mA	120 mA	1897 mA	87	2470µF
EC4BU-05S05	4.7-9 VDC	5 VDC	0 mA	2000 mA	120 mA	2299 mA	87	2000µF
EC4BU-05S12	4.7-9 VDC	12 VDC	0 mA	833 mA	50 mA	2298 mA	87	940µF
EC4BU-05S15	4.7-9 VDC	15 VDC	0 mA	666 mA	50 mA	2297 mA	87	690µF
EC4BU-05D05	4.7-9 VDC	±5 VDC	0 mA	±1000 mA	50 mA	2353 mA	85	1000µF
EC4BU-05D12	4.7-9 VDC	±12 VDC	0 mA	±416 mA	50 mA	2295 mA	87	440µF
EC4BU-05D15	4.7-9 VDC	±15 VDC	0 mA	±333 mA	50 mA	2297 mA	87	330µF
EC4BU-12S33	9-18 VDC	3.3 VDC	0 mA	2500 mA	30 mA	838 mA	82	2470µF
EC4BU-12S05	9-18 VDC	5 VDC	0 mA	2000 mA	30 mA	980 mA	85	2000µF
EC4BU-12S12	9-18 VDC	12 VDC	0 mA	833 mA	35 mA	957 mA	87	940µF
EC4BU-12S15	9-18 VDC	15 VDC	0 mA	666 mA	35 mA	956 mA	87	690µF
EC4BU-12D05	9-18 VDC	±5 VDC	0 mA	±1000 mA	45 mA	980 mA	85	1000µF
EC4BU-12D12	9-18 VDC	±12 VDC	0 mA	±416 mA	45 mA	957 mA	87	440µF
EC4BU-12D15	9-18 VDC	±15 VDC	0 mA	±333 mA	45 mA	957 mA	87	330µF
EC4BU-24S33	18-36 VDC	3.3 VDC	0 mA	2500 mA	25 mA	419 mA	82	2470µF
EC4BU-24S05	18-36 VDC	5 VDC	0 mA	2000 mA	25 mA	490 mA	85	2000µF
EC4BU-24S12	18-36 VDC	12 VDC	0 mA	833 mA	25 mA	478 mA	87	940µF
EC4BU-24S15	18-36 VDC	15 VDC	0 mA	666 mA	25 mA	478 mA	87	690µF
EC4BU-24D05	18-36 VDC	±5 VDC	0 mA	±1000 mA	25 mA	490 mA	85	1000µF
EC4BU-24D12	18-36 VDC	±12 VDC	0 mA	±416 mA	25 mA	478 mA	87	440µF
EC4BU-24D15	18-36 VDC	±15 VDC	0 mA	±333 mA	25 mA	478 mA	87	330µF
EC4BU-48S33	36-75 VDC	3.3 VDC	0 mA	2500 mA	20 mA	212 mA	81	2470µF
EC4BU-48S05	36-75 VDC	5 VDC	0 mA	2000 mA	20 mA	245 mA	85	2000µF
EC4BU-48S12	36-75 VDC	12 VDC	0 mA	833 mA	20 mA	239 mA	87	940µF
EC4BU-48S15	36-75 VDC	15 VDC	0 mA	666 mA	20 mA	239 mA	87	690µF
EC4BU-48D05	36-75 VDC	±5 VDC	0 mA	±1000 mA	20 mA	245 mA	85	1000µF
EC4BU-48D12	36-75 VDC	±12 VDC	0 mA	±416 mA	20 mA	239 mA	87	440µF
EC4BU-48D15	36-75 VDC	±15 VDC	0 mA	±333 mA	20 mA	239 mA	87	330µF

Derating Curve

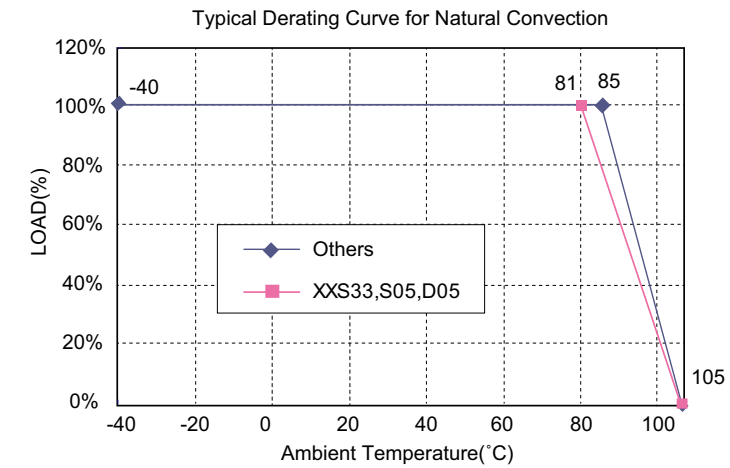

Specifications

All Specifications Typical At Nominal Line, Full Load, and 25°C Unless Otherwise Noted

INPUT SPECIFICATIONS

Input Voltage Range	5V	4.7-9V	
	12V	9-18V	
	24V	18-36V	
	48V	36-75V	
Under Voltage Lockout	5Vin	power up	4.4V
		power down	4.2V
	12Vin	power up	8.4V
		power down	8V
24Vin	power up	17V	
	power down	16V	
48Vin	power up	34V	
	power down	32V	
Input Surge Voltage (100ms max.)	5Vin	12Vdc max.	
	12Vin	25Vdc max.	
	24Vin	50Vdc max.	
	48Vin	100Vdc max.	
Input Filter		Pi Type	

OUTPUT SPECIFICATIONS

Voltage Accuracy		±1.5% max.
Voltage Balance (Dual)		±2.0% max.
Transient Response: 25% Step Load Change		< 500µs
Ripple & Noise, 20MHz BW		
(Measured with 0.1µF MLCC) 100mV pk-pk max.		
Temperature Coefficient		±0.03%/°C
Short Circuit Protection		Continuous
Line Regulation (note1)	Single	±0.2% max.
	Dual	±0.5% max.
Load Regulation (note2)	Single	±0.2% max.
	Dual	±1.0% max.
Cross Regulation (Dual output)		
Load cross variation 10%/100%		±5% max.
Over Voltage Protection		Zener or TVS Clamp
Current Limit		110%-140% Nominal Output
Start up time		20ms max.

GENERAL SPECIFICATIONS

Efficiency	See Table
Isolation Voltage	1500 VDC min.
Isolation Resistance	10 ⁹ ohm min.
Isolation Capacitance	1000pF typ.
Switching Frequency	350KHz typ.
EMI/RFI	Conductive EMI Meets EN55022 Class A
Case Grounding	Connect Case to -Vin with Decoupling Y Cap.
Operating Ambient Temperature Range	-40°C to +85°C
Derating, Above 85°C	Linearly to Zero Power at +105°C
Case Temperature (note 4)	105°C
Cooling	Natural Convection
Storage Temperature Range	-55°C to +125°C
Humidity	95% RH max. Non condensing
MTBF	MIL-STD-217-F, GB, 25°C, Full Load
Dimensions	1200Khrs
	2.00 x 1.00 x 0.4 inches (50.8 x 25.4 x 10.2 mm)
Case Material	Black Coated Copper with Non-Conductive Base
Weight	35 g

OPTION

- Suffix "T" to the model number with remote positive on/off control:
Logic Compatibility CMOS or open collector TTL, referenced to -Vin
Module On ±0.2% max.
Module Off ±0.5% max.
- Suffix "A" to the model number with output voltage adjustable external trim adj. range ≤ ±10%, single output models only.

NOTE

- Measured from high line to low line.
- Measured from full load to min. load.
- Maximum case temperature under any operating condition should not be exceeded 105°C.

EC5B SERIES

15 WATT, 2:1 INPUT RANGE

Visit www.cincon.com for new releases and a wider selection of products

Features

- ◆ 15W Isolated Output
- ◆ 2" x 1" Six-Sided Shield Metal Case
- ◆ Efficiency to 83%
- ◆ 2 : 1 Input Range
- ◆ Pi Input Filter
- ◆ Continuous Short Circuit Protection
- ◆ Meets EN55022 Class A, Conducted



Not Recommended For New Designs

Mechanical Dimensions

All Dimensions in Inches (mm)
 Tolerance Inches: X.XX=±0.04, X.XXX=±0.010
 Millimeters: X.X=±0.5, X.XX=±0.25

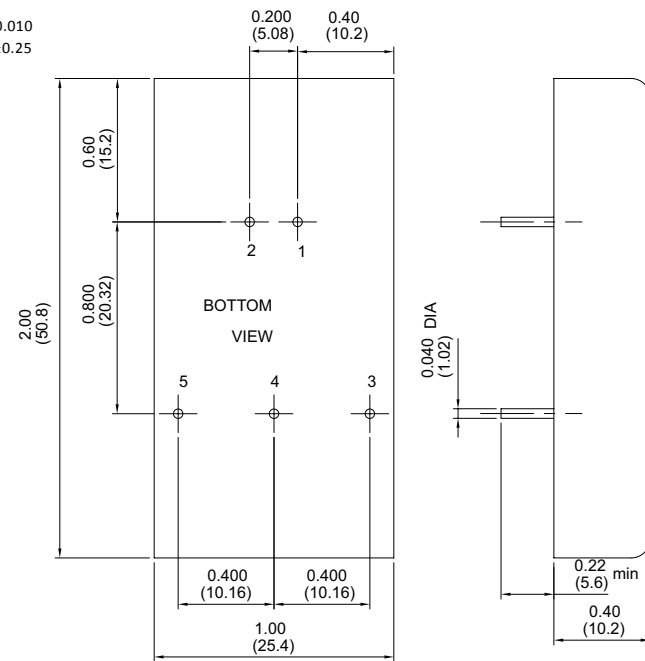

PIN CONNECTION	
Pin	Function
1	+Input
2	-Input
3	+Output
4	Common/NP
5	-Output

* NP-NO PIN ON SINGLE OUTPUT

MODEL NUMBER	INPUT VOLTAGE	OUTPUT VOLTAGE	OUTPUT CURRENT		INPUT CURRENT		% EFF.	CAPACITOR LOAD MAX.
			MIN.	MAX.	NO LOAD	FULL LOAD		
EC5B01	9-18 VDC	5 VDC	150 mA	3000 mA	20 mA	1610 mA	78	3000µF
EC5B02	9-18 VDC	12 VDC	65 mA	1250 mA	20 mA	1525 mA	82	1250µF
EC5B03	9-18 VDC	15 VDC	50 mA	1000 mA	20 mA	1525 mA	82	1000µF
EC5B04	9-18 VDC	±12 VDC	±35 mA	±625 mA	30 mA	1510 mA	83	625µF
EC5B05	9-18 VDC	±15 VDC	±25 mA	±500 mA	30 mA	1510 mA	83	500µF
EC5B06	9-18 VDC	±5 VDC	±75 mA	±1500 mA	30 mA	1565 mA	80	1500µF
EC5B07	9-18 VDC	3.3 VDC	150 mA	3000 mA	20 mA	1086 mA	76	3000µF
EC5B11	18-36 VDC	5 VDC	150 mA	3000 mA	20 mA	800 mA	78	3000µF
EC5B12	18-36 VDC	12 VDC	65 mA	1250 mA	20 mA	780 mA	80	1250µF
EC5B13	18-36 VDC	15 VDC	50 mA	1000 mA	20 mA	780 mA	80	1000µF
EC5B14	18-36 VDC	±12 VDC	±35 mA	±625 mA	30 mA	780 mA	80	625µF
EC5B15	18-36 VDC	±15 VDC	±25 mA	±500 mA	30 mA	780 mA	80	500µF
EC5B16	18-36 VDC	±5 VDC	±75 mA	±1500 mA	30 mA	780 mA	80	1500µF
EC5B17	18-36 VDC	3.3 VDC	150 mA	3000 mA	20 mA	543 mA	76	3000µF
EC5B21	36-72 VDC	5 VDC	150 mA	3000 mA	10 mA	390 mA	80	3000µF
EC5B22	36-72 VDC	12 VDC	65 mA	1250 mA	10 mA	380 mA	82	1250µF
EC5B23	36-72 VDC	15 VDC	50 mA	1000 mA	10 mA	380 mA	82	1000µF
EC5B24	36-72 VDC	±12 VDC	±35 mA	±625 mA	15 mA	380 mA	82	625µF
EC5B25	36-72 VDC	±15 VDC	±25 mA	±500 mA	15 mA	380 mA	82	500µF
EC5B26	36-72 VDC	±5 VDC	±75 mA	±1500 mA	15 mA	380 mA	82	1500µF
EC5B27	36-72 VDC	3.3 VDC	150 mA	3000 mA	15 mA	272 mA	76	3000µF

Derating Curve

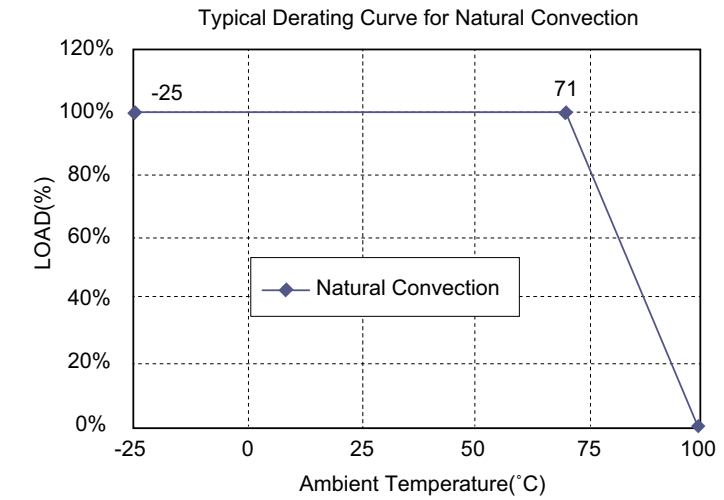

Specifications

All Specifications Typical At Nominal Line, Full Load, and 25°C Unless Otherwise Noted

INPUT SPECIFICATIONS

Input Voltage Range	12V 9-18V 24V 18-36V 48V 36-72V
Input Surge Voltage (100ms max.)	12V 25Vdc max. 24V 50Vdc max. 48V 100Vdc max.
Input Filter	Pi Type

OUTPUT SPECIFICATIONS

Voltage Accuracy	±1.0% max.
Voltage Balance (Dual)	±1.0% max.
Transient Response	
Single 25% Step Load Change	< 500µs
Dual FL-1/2L±1% Error Band	< 500µs
Ripple and Noise, 20MHz BW	100mV p-p max.
Temperature Coefficient	±0.02%/°C max.
Short Circuit Protection	Continuous
Line Regulation (note 1), Single/Dual Output	±0.2% max.
Load Regulation (note 2), Single/Dual Output	±1.0% max.
Start up time	12V _{in} 10ms Typ. 24V _{in} 120ms Typ. 48V _{in} 70ms Typ.

GENERAL SPECIFICATIONS

Efficiency	See Table
Isolation Voltage	500 VDC min
Isolation Resistance	10 ⁹ ohms
Isolation Capacitance	2500pF Typ.
Switching Frequency	200KHz, min.
Operating Ambient Temperature Range	-25°C to +71°C
De-rating, Above 71°C	Linearly to Zero power at 100°C
Case Temperature (note 4)	100°C max.
Cooling	Natural Convection
Storage Temperature Range	-40°C to +100°C
Humidity	95% RH max. Non condensing
MTBF MIL-STD-217F, GB, 25°C, Full Load	750K hrs Typ.
EMI/RFI	Six Sided Continuous Shield
Dimensions	2.00 x 1.00 x 0.40 inches (50.8 x 25.4 x 10.2mm)
Case Material	Black Coated Copper with Non-Conductive Base
Weight	35 g

NOTE

1. Measured from high line to low line.
2. Measured from full load to 1/4 load.
3. A minimum load on the output is necessary to maintain regulation
4. Maximum case temperature under any operating condition should not be exceeded 100°C.

EC5BE SERIES

15 WATT, 2:1 INPUT RANGE

Visit www.cincon.com for new releases and a wider selection of products

Features

- ◆ 15W Isolated Output
- ◆ 2" x 1" Six-Sided Shield Metal Case
- ◆ Efficiency to 83%
- ◆ 2 : 1 Input Range
- ◆ Pi Input Filter
- ◆ Continuous Short Circuit Protection
- ◆ Meets EN55022 Class A, Conducted
- ◆ Remote On/Off Control (Option)
- ◆ UL60950-1 Approval



Mechanical Dimensions

All Dimensions in Inches (mm)
 Tolerance Inches: X.XX=±0.04, X.XXX=±0.010
 Millimeters: X.X=±0.5, X.XX=±0.25

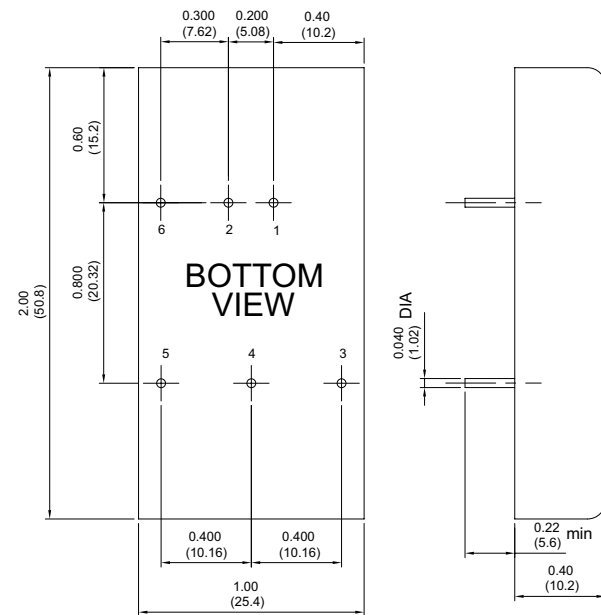

PIN CONNECTION	
Pin	Function
1	+Input
2	-Input
3	+Output
4	Common/NP/Trim(Optional)
5	-V Output
6	NP/Remote(Optional)

* NP-NO PIN ON SINGLE OUTPUT

MODEL NUMBER	INPUT VOLTAGE	OUTPUT VOLTAGE	OUTPUT CURRENT		INPUT CURRENT		% EFF.	CAPACITOR LOAD MAX.
			MIN.	MAX.	NO LOAD	FULL LOAD		
EC5BE01	9-18 VDC	5 VDC	0 mA	3000 mA	20 mA	1602 mA	78	3000µF
EC5BE02	9-18 VDC	12 VDC	0 mA	1250 mA	20 mA	1524 mA	82	1250µF
EC5BE03	9-18 VDC	15 VDC	0 mA	1000 mA	20 mA	1524 mA	82	1000µF
EC5BE04	9-18 VDC	±12 VDC	0 mA	±625 mA	30 mA	1506 mA	83	625µF
EC5BE05	9-18 VDC	±15 VDC	0 mA	±500 mA	30 mA	1506 mA	83	500µF
EC5BE06	9-18 VDC	±5 VDC	0 mA	±1500 mA	30 mA	1563 mA	80	1500µF
EC5BE07	9-18 VDC	3.3 VDC	0 mA	3000 mA	20 mA	1086 mA	76	3000µF
EC5BE11	18-36 VDC	5 VDC	0 mA	3000 mA	20 mA	780 mA	80	3000µF
EC5BE12	18-36 VDC	12 VDC	0 mA	1250 mA	20 mA	762 mA	82	1250µF
EC5BE13	18-36 VDC	15 VDC	0 mA	1000 mA	20 mA	762 mA	82	1000µF
EC5BE14	18-36 VDC	±12 VDC	0 mA	±625 mA	25 mA	755 mA	83	625µF
EC5BE15	18-36 VDC	±15 VDC	0 mA	±500 mA	25 mA	755 mA	83	500µF
EC5BE16	18-36 VDC	±5 VDC	0 mA	±1500 mA	25 mA	772 mA	81	1500µF
EC5BE17	18-36 VDC	3.3 VDC	0 mA	3000 mA	20 mA	543 mA	76	3000µF
EC5BE21	36-72 VDC	5 VDC	0 mA	3000 mA	15 mA	391 mA	80	3000µF
EC5BE22	36-72 VDC	12 VDC	0 mA	1250 mA	15 mA	377 mA	83	1250µF
EC5BE23	36-72 VDC	15 VDC	0 mA	1000 mA	15 mA	377 mA	83	1000µF
EC5BE24	36-72 VDC	±12 VDC	0 mA	±625 mA	20 mA	377 mA	83	625µF
EC5BE25	36-72 VDC	±15 VDC	0 mA	±500 mA	20 mA	377 mA	83	500µF
EC5BE26	36-72 VDC	±5 VDC	0 mA	±1500 mA	20 mA	381 mA	82	1500µF
EC5BE27	36-72 VDC	3.3 VDC	0 mA	3000 mA	15 mA	271 mA	76	3000µF

Derating Curve

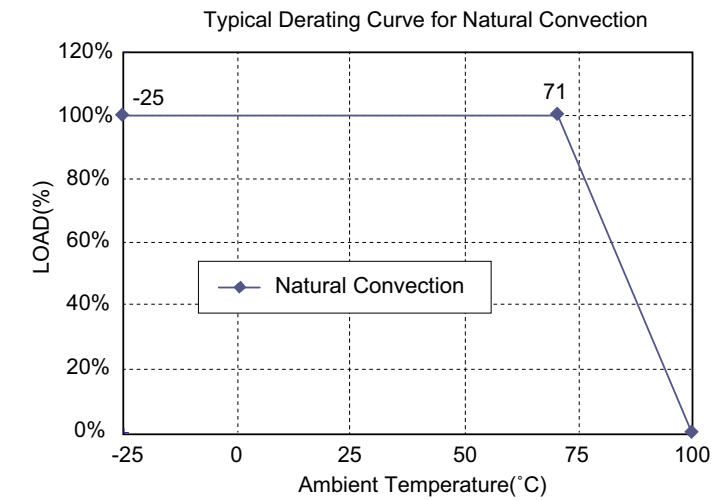

Specifications

All Specifications Typical At Nominal Line, Full Load, and 25°C Unless Otherwise Noted

INPUT SPECIFICATIONS

Input Voltage Range	12V 9-18V 24V 18-36V 48V 36-72V
Input Surge Voltage (100ms max.)	12V 50Vdc max. 24V 100Vdc max. 48V 100Vdc max.
Input Filter	Pi Type

OUTPUT SPECIFICATIONS

Voltage Accuracy	±1.0% max.
Voltage Balance (Dual)	±1.0% max.
Transient Response	
Single 25% Step Load Change	< 500µs
Dual FL-1/2L±1% Error Band	< 500µs
Ripple and Noise, 20MHz BW	75mV p-p max.
Temperature Coefficient	±0.02%/°C max.
Short Circuit Protection	Continuous
Line Regulation (note 1)	±0.2% max.
Load Regulation (note 2)	±1.0% max.
Start up time	20ms typ. (EC5BE21, EC5BE27)

GENERAL SPECIFICATIONS

Efficiency	See Table
Isolation Voltage	500 VDC min
Isolation Resistance	10 ⁸ ohms
Isolation Capacitance	500pF typ.
Switching Frequency	300KHz typ.
Operating Ambient Temperature Range	-25°C to +71°C
De-rating, Above 71°C	Linearly to Zero power at 100°C
Case Temperature (note 3)	100°C max.
Storage Temperature Range	-40°C to +100°C
Humidity	95% RH max. Non condensing
MTBF MIL-STD-217F, GB, 25°C, Full Load	1500Khrs typ.
EMI/RFI	Six sided Continuous Shield
Dimensions	2.00 x 1.00 x 0.40 inches (50.8 x 25.4 x 10.2mm)
Case Material	Black Coated Copper with Non-Conductive Base
Weight	32 g

NOTE

1. Measured from high line to low line.
2. Measured from full load to 1/4 load.
3. Maximum case temperature under any operating condition should not be exceeded 100°C.

OUTPUT SPECIFICATIONS

1. Suffix "T" to the Model Number with Remote On/Off Remote On/Off Control:

Logic Compatibility	COMS or Open Collector TTL
EC-On	>+5.5VDC or Open Circuit
EC-Off	< 1.8VDC
Control Common	Referenced to input Minus
2. Suffix "A" to the Model Number with Output Voltage Adjustable External Trim Adj. Range ≥ ±10%, Single Output Only

EC5BW SERIES

15 WATT, 4:1 INPUT RANGE

Visit www.cincon.com for new releases and a wider selection of products

Features

- ◆ 15W Isolated Output
- ◆ Efficiency to 88%
- ◆ 2" x 1" Six-Sided Shield Metal Case
- ◆ 4 : 1 Input Range
- ◆ Regulated Outputs
- ◆ Fixed Switching Frequency
- ◆ Input Under Voltage Protection
- ◆ Over Current Protection
- ◆ Remote On/Off (Option)
- ◆ Continuous Short Circuit Protection
- ◆ No Tantalum Capacitor Inside
- ◆ Conductive EMI Meets EN55022 Class A
- ◆ CE Mark Meets 2004/108/EC
- ◆ Safety Meets UL60950-1, EN60950-1 and IEC60950-1

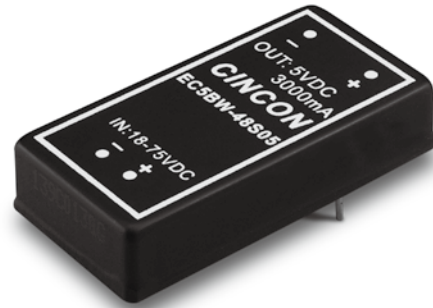

Mechanical Dimensions

NOTE: Pin Size is 0.04±0.004 Inch (1.0±0.1 mm)DIA
All Dimensions in Inches (mm)
Tolerance Inches: X.XX±0.04, X.XXX±0.010
Millimeters: X.X±0.5, X.XX±0.25

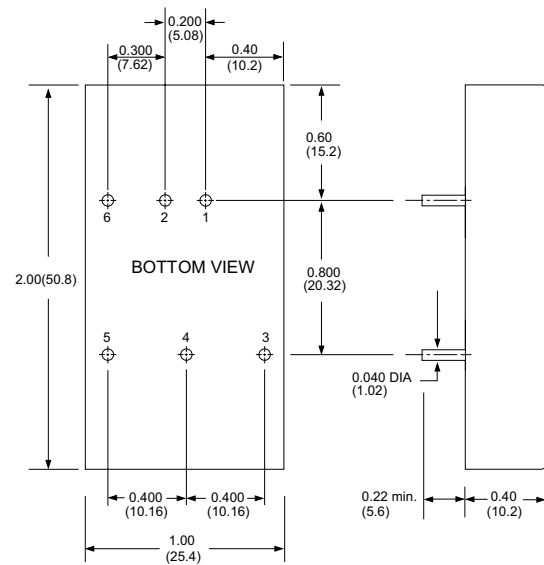

PIN CONNECTION	
Pin	Function
1	+Input
2	-Input
3	+Output
4	Common/NP
5	-Output
6	NP(Remote On/Off)

* NP-NO PIN ON SINGLE OUTPUT

MODEL NUMBER	INPUT VOLTAGE	OUTPUT VOLTAGE	OUTPUT CURRENT		INPUT CURRENT		% EFF.	CAPACITOR LOAD MAX.
			MIN.	MAX.	NO LOAD	FULL LOAD		
EC5BW-24S33	9-36 VDC	3.3 VDC	0 mA	4000 mA	60 mA	632 mA	87	4000µF
EC5BW-24S05	9-36 VDC	5 VDC	0 mA	3000 mA	70 mA	718 mA	87	3000µF
EC5BW-24S12	9-36 VDC	12 VDC	0 mA	1250 mA	30 mA	718 mA	87	1250µF
EC5BW-24S15	9-36 VDC	15 VDC	0 mA	1000 mA	30 mA	710 mA	88	1000µF
EC5BW-24D05	9-36 VDC	±5 VDC	0 mA	±1500 mA	30 mA	735 mA	85	1500µF
EC5BW-24D12	9-36 VDC	±12 VDC	0 mA	±625 mA	30 mA	718 mA	87	625µF
EC5BW-24D15	9-36 VDC	±15 VDC	0 mA	±500 mA	30 mA	710 mA	88	470µF
EC5BW-48S33	18-75 VDC	3.3 VDC	0 mA	4000 mA	40 mA	313 mA	88	4000µF
EC5BW-48S05	18-75 VDC	5 VDC	0 mA	3000 mA	40 mA	355 mA	88	3000µF
EC5BW-48S12	18-75 VDC	12 VDC	0 mA	1250 mA	20 mA	359 mA	87	1250µF
EC5BW-48S15	18-75 VDC	15 VDC	0 mA	1000 mA	20 mA	359 mA	87	1000µF
EC5BW-48D05	18-75 VDC	±5 VDC	0 mA	±1500 mA	20 mA	368 mA	85	1500µF
EC5BW-48D12	18-75 VDC	±12 VDC	0 mA	±625 mA	20 mA	359 mA	87	625µF
EC5BW-48D15	18-75 VDC	±15 VDC	0 mA	±500 mA	20 mA	359 mA	87	470µF

Derating Curve

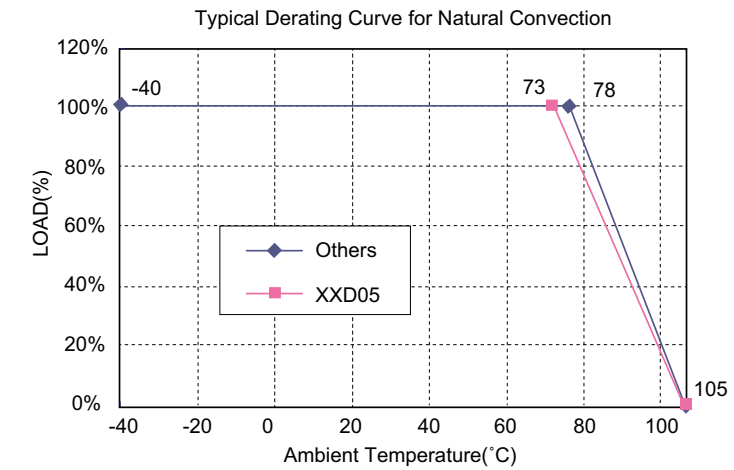

Specifications

All Specifications Typical At Nominal Line, Full Load, and 25°C Unless Otherwise Noted

INPUT SPECIFICATIONS

Input Voltage Range	24VDC 9-36VDC 48VDC 18-75VDC
Input Surge Voltage (100ms max.)	24VDC 50VDC max. 48VDC 100VDC max.
Under Voltage Lockout	24Vin 8.8VDC typ. 48Vin 17VDC typ.
Input Filter	PI Type

OUTPUT SPECIFICATIONS

Voltage Accuracy	±1.5% max.
Voltage Balance (Dual)	±2.0% max.
Transient Response:	
75% - 100% Step Load Change	±5% Vout nominal, < 250µs
Error Band	
Recovery Time	
Ripple & Noise, 20MHz BW (Measured with 0.1µF MLCC)	
Vo=3.3 & 5V	75mV pk-pk max.
Vo=12V & 15V & ±12V & ±15V	100mV pk-pk max.
Temperature Coefficient	±0.03%/C max.
Short Circuit Protection	Continuous
Line Regulation (note 1)	±0.2% max.
	±0.5% max.
Load Regulation (note 2)	±0.2% max.
	±1.0% max.
Cross Regulation (Dual Output)	
Load Cross Variation 10%/100%	±5% max.
Over Voltage Protection	Zener or TVS Clamp
Current Limit	110% - 170% Nominal Output
Output Short Circuit Protection	Continuous (Hiccup Mode)
Start Up Time	10ms typ.

GENERAL SPECIFICATIONS

Efficiency	See Table
Isolation Voltage	1500 VDC min.
Isolation Resistance	10 ⁹ ohm min.
Isolation Capacitance	1000pF typ.
Switching Frequency	400KHz typ.
EMI/RFI	Conductive EMI Meets EN55022 Class A
Case Grounding	Connect Case to -Vin with Decoupling Y Cap
Operating Ambient Temperature Range	-40°C to +85°C
De-rating, Above 78°C	Linearly to Zero Power at +105°C
Case Temperature (note 3)	105°C
Cooling	Natural Convection
Storage Temperature Range	-55°C to +125°C
Humidity	95% RH max. Non-Condensing
MTBF.....MIL-STD-217F, GB 25C, Full Load	T.B.D. hrs
Dimensions	2.00 x 1.00 x 0.40 inches (50.8 x 25.4 x 10.2 mm)
Case Material	Black Coated Copper with Non-Conductive Base
Weight	35 g

NOTE

- Suffix "T" to the model number with remote positive On/Off control: Logic compatibility CMOS or open collector TTL, referenced to -Vin
Module On >3.5VDC to 75VDC or open circuit
Module Off < 1.2VDC
- Suffix "A" to the model number with output voltage adjustable external trim adj. Range ≥ ±10%, single output only.

EC5BU SERIES

15 WATT, 2:1 INPUT RANGE

Visit www.cincon.com for new releases and a wider selection of products

Features

- ◆ 15W Isolated Output
- ◆ Efficiency to 90%
- ◆ 2 : 1 Input Rang
- ◆ Regulated Outputs
- ◆ Fixed Switching Frequency
- ◆ Input Under Voltage Protection
- ◆ Over Current Protection
- ◆ Conductive EMI Meets EN55022 Class A
- ◆ Continuous Short Circuit Protection
- ◆ Without Tantalum Capacitors Inside
- ◆ CE Mark Meets 2004/108/EC
- ◆ Safety Meets UL60950-1, EN60950-1 and IEC60950-1

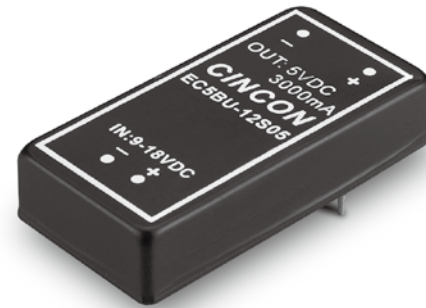

Mechanical Dimensions

NOTE: Pin Size is 0.04±0.004 Inch(1.0±0.1mm)DIA
All Dimensions in Inches (mm)
Tolerance Inches: X.XX=±0.04, X.XXX=±0.010
Millimeters: X.X=±0.5, X.XX=±0.25

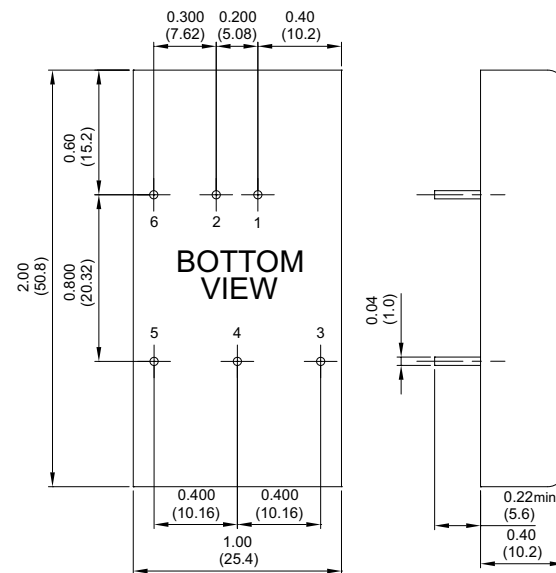

PIN CONNECTION	
Pin	Function
1	+Input
2	-Input
3	+V Output
4	Common/NP/Trim(Optional)
5	-V Output
6	NP/Remote(Optional)

* NP-NO PIN ON SINGLE OUTPUT

MODEL NUMBER	INPUT VOLTAGE	OUTPUT VOLTAGE	OUTPUT CURRENT		INPUT CURRENT		% EFF.	CAPACITOR LOAD MAX.
			MIN.	MAX.	NO LOAD	FULL LOAD		
EC5BU-12S33	9-18 VDC	3.3 VDC	0 mA	4000 mA	90 mA	1280 mA	85	4000µF
EC5BU-12S05	9-18 VDC	5 VDC	0 mA	3000 mA	85 mA	1453 mA	88	3000µF
EC5BU-12S12	9-18 VDC	12 VDC	0 mA	1250 mA	70 mA	1420 mA	88	1330µF
EC5BU-12S15	9-18 VDC	15 VDC	0 mA	1000 mA	70 mA	1420 mA	88	1000µF
EC5BU-12D05	9-18 VDC	±5 VDC	0 mA	±1500 mA	45 mA	1470 mA	85	1470µF
EC5BU-12D12	9-18 VDC	±12 VDC	0 mA	±625 mA	45 mA	1436 mA	87	660µF
EC5BU-12D15	9-18 VDC	±15 VDC	0 mA	±500 mA	45 mA	1420 mA	88	550µF
EC5BU-24S33	18-36 VDC	3.3 VDC	0 mA	4000 mA	50 mA	640 mA	86	4000µF
EC5BU-24S05	18-36 VDC	5 VDC	0 mA	3000 mA	50 mA	718 mA	89	3000µF
EC5BU-24S12	18-36 VDC	12 VDC	0 mA	1250 mA	20 mA	695 mA	90	1330µF
EC5BU-24S15	18-36 VDC	15 VDC	0 mA	1000 mA	20 mA	695 mA	90	1000µF
EC5BU-24D05	18-36 VDC	±5 VDC	0 mA	±1500 mA	25 mA	726 mA	86	1470µF
EC5BU-24D12	18-36 VDC	±12 VDC	0 mA	±625 mA	25 mA	710 mA	88	660µF
EC5BU-24D15	18-36 VDC	±15 VDC	0 mA	±500 mA	25 mA	702 mA	89	550µF
EC5BU-48S33	36-75 VDC	3.3 VDC	0 mA	4000 mA	25 mA	320 mA	86	4000µF
EC5BU-48S05	36-75 VDC	5 VDC	0 mA	3000 mA	30 mA	359 mA	88	3000µF
EC5BU-48S12	36-75 VDC	12 VDC	0 mA	1250 mA	20 mA	347 mA	90	1330µF
EC5BU-48S15	36-75 VDC	15 VDC	0 mA	1000 mA	20 mA	351 mA	90	1000µF
EC5BU-48D05	36-75 VDC	±5 VDC	0 mA	±1500 mA	20 mA	363 mA	86	1470µF
EC5BU-48D12	36-75 VDC	±12 VDC	0 mA	±625 mA	20 mA	355 mA	88	660µF
EC5BU-48D15	36-75 VDC	±15 VDC	0 mA	±500 mA	20 mA	351 mA	89	550µF

Derating Curve

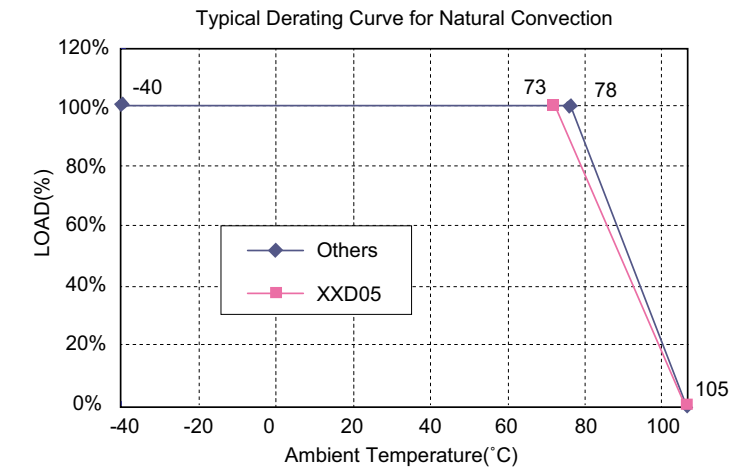

Specifications

All Specifications Typical At Nominal Line, Full Load, and 25°C Unless Otherwise Noted

INPUT SPECIFICATIONS

Input Voltage Range	12V 9-18V	24V 18-36V	48V 36-75V	
Under Voltage Lockout	12Vin	power up 8.4V power down 8V	24Vin	power up 17V power down 16V
Input Surge Voltage (100ms max.)	12Vin	25Vdc max.	24Vin	50Vdc max.
Input Filter	48Vin	100Vdc max.	Pi Type	

OUTPUT SPECIFICATIONS

Voltage Accuracy	±1.5% max.
Voltage Balance (Dual)	±2.0% max.
Transient Response: 25% Step Load Change	< 500µs
Ripple & Noise, 20MHz BW (Measured with 0.1µF MLCC)	100mV pk-pk max.
Temperature Coefficient	±0.03%/°C
Short Circuit Protection	Continuous
Line Regulation (note 1)	Single: ±0.2% max. Dual: ±0.5% max.
Load Regulation (note 2)	Single: ±0.2% max. Dual: ±1.0% max.
Cross Regulation (Dual output)	±5% max.
Load cross variation 10%/100%	±5% max.
Over Voltage Protection	Zener or TVS Clamp
Current Limit	110%-140% Nominal Output
Start up time	20ms max.

GENERAL SPECIFICATIONS

Efficiency	See Table
Isolation Voltage	1500 VDC min.
Isolation Resistance	10 ⁹ ohm min.
Isolation Capacitance	1000pF typ.
Switching Frequency	350KHz typ.
EMI/RFI	Conductive EMI Meets EN55022 Class A
Case Grounding	Connect Case to -Vin with Decoupling Y Cap
Operating Ambient Temperature Range	-40°C to +85°C
Derating, Above 78°C	Linearly to Zero Power at +105°C
Case Temperature (note 4)	105°C
Cooling	Natural Convection
Storage Temperature Range	-55°C to +125°C
Humidity	95% RH max. Non condensing
MTBF MIL-STD-217-F, GB, 25°C, Full Load	1200Khrs typ.
Dimensions	2.00 x 1.00 x 0.4 inches (50.8 x 25.4 x 10.2 mm)
Case Material	Black Coated Copper with Non-Conductive Base
Weight	35 g

OPTION

- Suffix "T" to the model number with remote positive on/off control:
Logic Compatibility: CMOS or Open Collector TTL, Referenced to -Vin
Module On: >3.5VDC to 75VDC or open circuit
Module Off: <1.2VDC
- Suffix "A" to the model number with output voltage adjustable external trim adj. range $\leq \pm 10\%$, single output models only.

NOTE

- Suffix "T" to the model number with remote positive On/Off control:
Logic compatibility CMOS or open collector TTL, referenced to -Vin
Module On >3.5VDC to 75VDC or open circuit
Module Off < 1.2VDC
- Suffix "A" to the model number with output voltage adjustable external trim adj. Range $\geq \pm 10\%$, single output only

EC7B SERIES

20 WATT, 2:1 INPUT RANGE

Visit www.cincon.com for new releases and a wider selection of products

Features

- ◆ 20W Isolated Output
- ◆ Efficiency to 90%
- ◆ Fixed Switching Frequency
- ◆ 2 : 1 Input Range
- ◆ Regulated Outputs
- ◆ Continuous Short Circuit Protection
- ◆ Pi Input Filter
- ◆ CE Mark Meets 2004/108/EC
- ◆ UL60950-1 Approval



Mechanical Dimensions

NOTE: Pin Size is 0.04±0.004 Inch(1.0±0.1mm)DIA
All Dimensions in Inches (mm)
Tolerance Inches: X.XX=±0.04, X.XXX=±0.010
Millimeters: X.X=±0.5, X.XX=±0.25

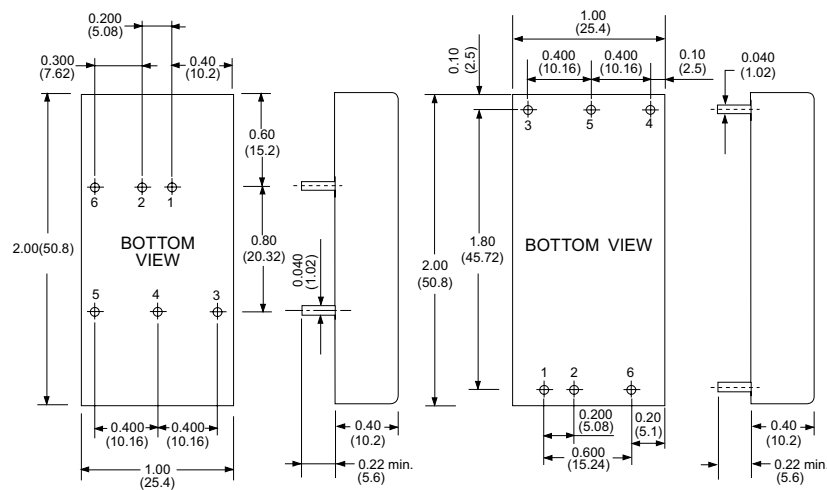

PIN CONNECTION	
Pin	Function
1	+Input
2	-Input
3	+Output
4	Common/NP
5	-Output
6	NP(Remote On/Off)

* NP-NO PIN ON SINGLE OUTPUT

MODEL NUMBER	INPUT VOLTAGE	OUTPUT VOLTAGE	OUTPUT CURRENT		INPUT CURRENT		% EFF.	CAPACITOR LOAD MAX.
			MIN.	MAX.	NO LOAD	FULL LOAD		
EC7B-12D12	9-18 VDC	±12 VDC	42 mA	±835 mA	40 mA	1856 mA	90	1000µF
EC7B-12D15	9-18 VDC	±15 VDC	33 mA	±670 mA	40 mA	1861 mA	90	800µF
EC7B-24S18	18-36 VDC	1.8 VDC	0 mA	6000 mA	30 mA	523 mA	86	6000µF
EC7B-24S25	18-36 VDC	2.5 VDC	0 mA	6000 mA	30 mA	710 mA	88	6000µF
EC7B-24S33	18-36 VDC	3.3 VDC	0 mA	5000 mA	40 mA	764 mA	90	5000µF
EC7B-24S05	18-36 VDC	5 VDC	0 mA	4000 mA	60 mA	926 mA	90	4000µF
EC7B-24S12	18-36 VDC	12 VDC	0 mA	1670 mA	20 mA	928 mA	90	2000µF
EC7B-24S15	18-36 VDC	15 VDC	0 mA	1330 mA	20 mA	924 mA	90	2000µF
EC7B-24D12	18-36 VDC	±12 VDC	42 mA	±835 mA	20 mA	928 mA	90	1000µF
EC7B-24D15	18-36 VDC	±15 VDC	33 mA	±670 mA	20 mA	930 mA	90	800µF
EC7B-48S18	36-75 VDC	1.8 VDC	0 mA	6000 mA	30 mA	262 mA	86	6000µF
EC7B-48S25	36-75 VDC	2.5 VDC	0 mA	6000 mA	30 mA	359 mA	87	6000µF
EC7B-48S33	36-75 VDC	3.3 VDC	0 mA	5000 mA	30 mA	386 mA	89	5000µF
EC7B-48S05	36-75 VDC	5 VDC	0 mA	4000 mA	40 mA	463 mA	90	4000µF
EC7B-48S12	36-75 VDC	12 VDC	0 mA	1670 mA	15 mA	469 mA	89	2000µF
EC7B-48S15	36-75 VDC	15 VDC	0 mA	1330 mA	15 mA	472 mA	88	2000µF
EC7B-48D12	36-75 VDC	±12 VDC	42 mA	±835 mA	10 mA	464 mA	90	1000µF
EC7B-48D15	36-75 VDC	±15 VDC	33 mA	±670 mA	10 mA	471 mA	89	800µF

Derating Curve

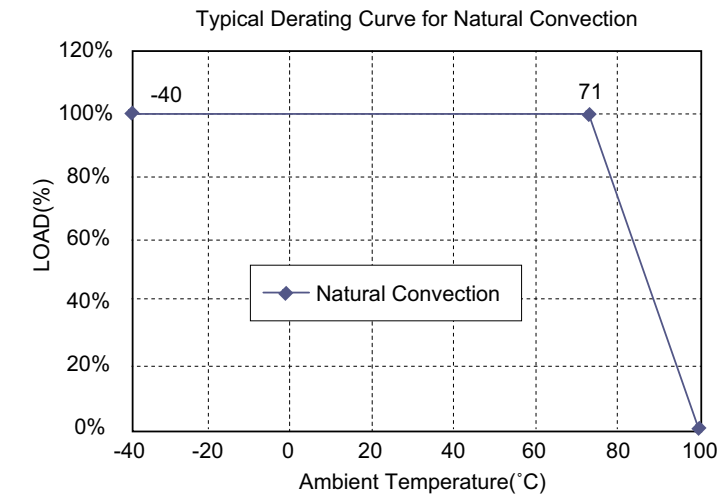

Specifications

All Specifications Typical At Nominal Line, Full Load, and 25°C Unless Otherwise Noted

INPUT SPECIFICATIONS

Input Voltage Range	12V 9-18V	24V 18-36V	48V 36-75V			
Input Surge Voltage (100ms max.)	12V 25Vdc max.	24V 50Vdc max.	48V 100Vdc max.			
Under Voltage Lockout	12VIn	power up 8.8V power down 8.0V	24VIn	power up 17V power down 16V	48VIn	power up 34V power down 33V
Positive Logic Remote On/Off (see note 3 & 4)	Pi Type					
Input Filter	Pi Type					

OUTPUT SPECIFICATIONS

Voltage Accuracy	±1.5% max.
Voltage Balance (Dual)	±2.0% max.
Transient Response: 75% - 100% Step Load Change	Error Band ±5% Vout nominal, Recovery Time < 500µs
Ripple & Noise, 20MHz BW (Measured with 0.1µF MLCC)	75mVpk-pk, max.
Temperature Coefficient	±0.03%/°C
Line Regulation (note 1)	Single ±0.2% max. Dual ±0.5% max.
Load Regulation (note 2)	±1.0% max.
Over Voltage Protection	Zener or TVS Clamp
Output Short Circuit Protection	Continuous
External Trim Adj. Range	Single ±10%
Start up time	EC7B-24S12/15 13ms typ. EC7B-48S12/15 22ms typ.
Other	5ms typ.

GENERAL SPECIFICATIONS

Efficiency	See Table
Isolation Voltage	Input/Output 1500VDC max.
Isolation Resistance	10 ⁸ ohm min.
Isolation Capacitance	1000pF typ.
Switching Frequency	350KHz typ.
EMI/RFI	Six Sided Continuous Shield
Operating Ambient Temperature	-40°C to +85°C
De-rating, Above 71°C	Linearly to Zero power at 100°C
Case Temperature (note 6)	100°C max.
Cooling	Natural Convection
Storage Temperature	-55°C to +125°C
Humidity	95% RH max. Non condensing
MTBF MIL-STD-217F, GB, 25°C, Full Load	Single 900Khrs typ. Dual 740Khrs typ.
Dimensions	2.00 x 1.00 x 0.40 inches (50.8 x 25.4 x 10.2 mm)
Case Material	Black Coated Copper with Non-Conductive Base
Weight	35 g

NOTE

1. Measured from high line to low line.
2. Measured from full load to 10% load.
3. Logic compatibility CMOS or open collector TTL, ref. to -Vin
Module On >5.5VDC or open circuit
Module Off < 1.2VDC
4. Suffix "N" to the model number with negative logic remote on/off
Module On < 1.2VDC
Module Off >5.5VDC or open circuit
5. Suffix "S" to the model number with alternative pin configuration, single output models only.
6. Maximum case temperature under any operating condition should not be exceeded 100°C.

EC7BW SERIES

20 WATT, 4 : 1 INPUT RANGE

Visit www.cincon.com for new releases and a wider selection of products

Features

- ◆ 20W Isolated Output
- ◆ 2" x 1" x 0.4" Shielded Metal Case
- ◆ Efficiency to 90%
- ◆ Fixed Switching Frequency
- ◆ 4 : 1 Wide Input Range
- ◆ Regulated Outputs
- ◆ Continuous Short Circuit Protection
- ◆ Pi Input Filter
- ◆ CE Mark Meets 2004/108/EC
- ◆ Safety Meets UL60950-1, EN60950-1, and IEC60950-1

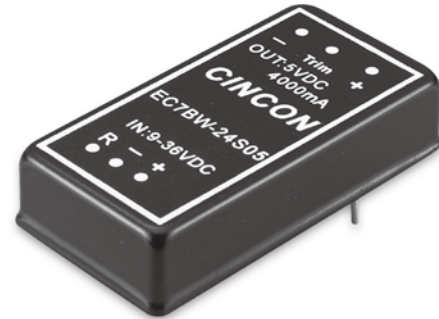

Mechanical Dimensions

NOTE: Pin Size is 0.04±0.004 Inch (1.0±0.1 mm)DIA
All Dimensions in Inches (mm)
Tolerance Inches: X.XX=±0.04, X.XXX=±0.010
Millimeters: X.X=±0.5, X.XX=±0.25

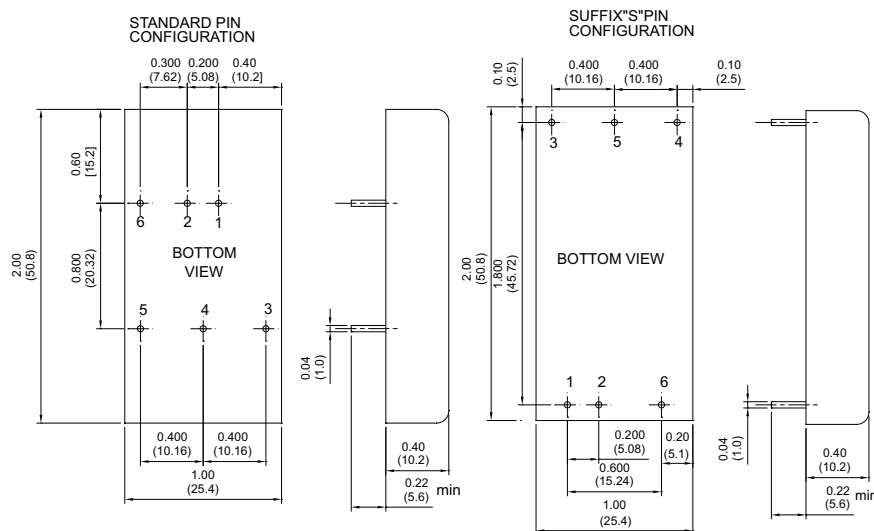

PIN CONNECTION		
PIN	Single Output	Dual Output
1	+V Input	+V Input
2	-V Input	-V Input
3	+V Output	+V Output
4	Trim	Common
5	-V Output	-V Output
6	Remote On/Off	

MODEL NUMBER	INPUT VOLTAGE	OUTPUT VOLTAGE	OUTPUT CURRENT		INPUT CURRENT		% EFF.	CAPACITOR LOAD MAX.
			MIN.	MAX.	NO LOAD	FULL LOAD		
EC7BW-24S33	9-36 VDC	3.3 VDC	0 mA	5500 mA	55 mA	869 mA	87	5500µF
EC7BW-24S05	9-36 VDC	5 VDC	0 mA	4000 mA	55 mA	926 mA	90	4000µF
EC7BW-24S12	9-36 VDC	12 VDC	0 mA	1670 mA	55 mA	928 mA	90	1800µF
EC7BW-24S15	9-36 VDC	15 VDC	0 mA	1330 mA	55 mA	924 mA	90	1500µF
EC7BW-24D05	9-36 VDC	± 5 VDC	0 mA	±2000 mA	70 mA	937 mA	89	2000µF
EC7BW-24D12	9-36 VDC	± 12 VDC	0 mA	±835 mA	35 mA	947 mA	88	1000µF
EC7BW-24D15	9-36 VDC	± 15 VDC	0 mA	±666 mA	35 mA	947 mA	88	800µF
EC7BW-48S33	18-75 VDC	3.3 VDC	0 mA	5500 mA	25 mA	430 mA	88	5500µF
EC7BW-48S05	18-75 VDC	5 VDC	0 mA	4000 mA	25 mA	463 mA	90	4000µF
EC7BW-48S12	18-75 VDC	12 VDC	0 mA	1670 mA	25 mA	464 mA	90	1800µF
EC7BW-48S15	18-75 VDC	15 VDC	0 mA	1330 mA	25 mA	462 mA	90	1500µF
EC7BW-48D05	18-75 VDC	± 5 VDC	0 mA	±2000 mA	35 mA	468 mA	89	2000µF
EC7BW-48D12	18-75 VDC	± 12 VDC	0 mA	±835 mA	25 mA	474 mA	88	1000µF
EC7BW-48D15	18-75 VDC	± 15 VDC	0 mA	±666 mA	25 mA	474 mA	88	800µF

Derating Curve

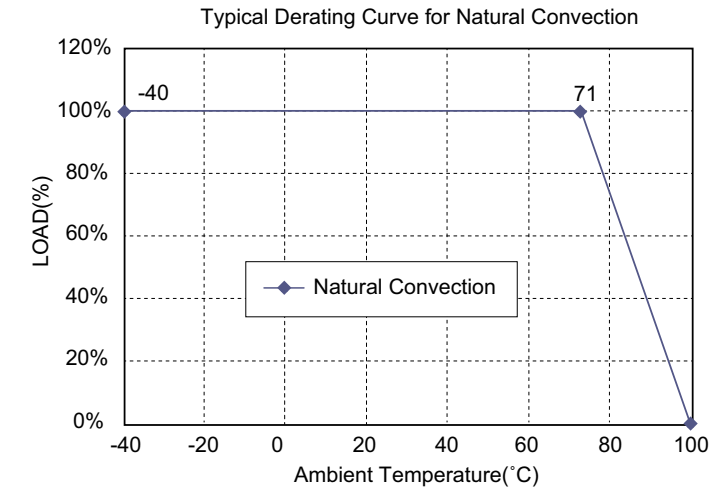

Specifications

All Specifications Typical At Nominal Line, Full Load, and 25°C Unless Otherwise Noted

INPUT SPECIFICATIONS

Input Voltage Range	24V 9-36V 48V 18-75V
Input Surge Voltage (100ms max.)	24V 50Vdc max. 48V 100Vdc max.
Under voltage lockout	24V 48V
Positive Logic Remote On/Off (note 3 & 4)	power up 8.8V typ. power down 8.0V typ. power up 17V typ. power down 16V typ.
Input Filter	PI Type

OUTPUT SPECIFICATIONS

Voltage Accuracy	±1.5% max.
Voltage Balance (Dual Output)	±1.0% max.
Transient Response: 75%-100% Step Load Change	
Error Band	±5% Vout Nominal
Recovery Time	< 500µs
Ripple & Noise, 20MHz BW (Measured with 0.1µF MLCC)	75mV pk-pk, max.
Temperature Coefficient	±0.03%/°C
Line Regulation (note 1)	±0.2% max.
	Single
	Dual
	±0.5% max.
Load Regulation (note 2)	±1.0% max.
Cross Regulation (Dual output)	
Load cross variation 25%/100%	±5.0% max. Over Voltage
Protection	Zener or TVS Clamp
Output Short Circuit Protection	Continuous
External Trim Adj. Range (Single Output Models only)	±10%
Start up time	5ms typ.

GENERAL SPECIFICATIONS

Efficiency	See Table
Isolation Voltage	Input/Output 1500VDC max.
Isolation Resistance	10 ⁸ ohm min.
Isolation Capacitance	1000pF typ.
Switching Frequency	50KHz typ.
	Single
	Dual
	400KHz typ.
EMI/RFI	Six Sided Continuous Shield
Operating Ambient Temperature	-40°C to +85°C
De-rating, Above 71°C	Linearly to Zero power at 105°C
Case Temperature (note 6)	105°C max.
Storage Temperature	-55°C to +125°C
Humidity	95% RH max. Non condensing
MTBF MIL-STD-217F, GB, 25°C, Full Load	720Khrs typ.
Dimensions	2.00 x 1.00 x 0.40 inches (50.8 x 25.4 x 10.2 mm)
Case Material	Black Coated Copper with Non-Conductive Base
Weight	35 g

NOTE

1. Measured from high line to low line.
2. Measured from full load to zero load.
3. Logic compatibility CMOS or open collector TTL, ref. to -Vin
Module On >5.5VDC to 75VDC or open circuit
Module Off < 1.2VDC
4. Suffix "N" to the model number with negative logic remote on/off
Module On < 1.2VDC
Module Off >5.5VDC to 75VDC or open circuit
5. Suffix "S" to the model number with alternative pin configuration, single output models only.
6. Maximum case temperature under any operating condition should not be exceeded 105°C.

EC7BW-110 SERIES

20 WATT, INPUT RANGE 43-160 VDC

Visit www.cincon.com for new releases and a wider selection of products

Features

- ◆ 20W Isolated Output
- ◆ Efficiency to 90%
- ◆ 250KHz Switching Frequency
- ◆ 4 : 1 Input Range
- ◆ Regulated Outputs
- ◆ Remote On/Off
- ◆ Low No Load Power Consumption
- ◆ Continuous Short Circuit Protection
- ◆ 2" x 1" x 0.4" Size Meet Industrial Standard
- ◆ CE Mark Meets 2004/108/EC
- ◆ UL60950-1 (Basic Insulation) Approval
- ◆ Meet EN50155



Mechanical Dimensions

NOTE: Pin Size is 0.04±0.004 Inch (1.0±0.1 mm)DIA
All Dimensions in Inches (mm)
Tolerance Inches: X.XX=±0.04, X.XXX=±0.010
Millimeters: X.X=±0.5, X.XX=±0.25

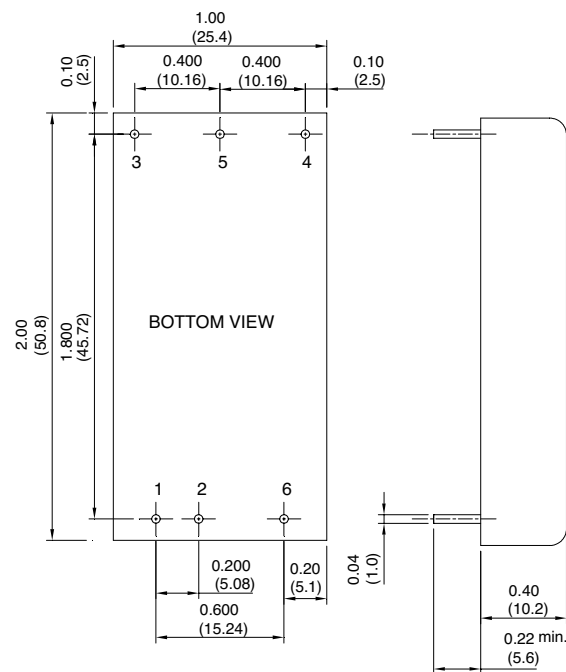

PIN CONNECTION		
PIN	Single Output	Dual Output
1	+V Input	+V Input
2	-V Input	-V Input
3	+V Output	+V Output
4	Trim	-V Output
5	-V Output	Common
6	Remote On/Off	

MODEL NUMBER	INPUT VOLTAGE	OUTPUT VOLTAGE	OUTPUT CURRENT		INPUT CURRENT		% EFF.	CAPACITOR LOAD MAX.
			MIN.	MAX.	NO LOAD	FULL LOAD		
EC7BW-110S05	43-160 VDC	5 VDC	0 mA	4000 mA	3 mA	205.4 mA	88.5	5600µF
EC7BW-110S12	43-160 VDC	12 VDC	0 mA	1670 mA	3 mA	202.0 mA	90	1000µF
EC7BW-110S15	43-160 VDC	15 VDC	0 mA	1330 mA	3 mA	203.1 mA	89.5	1000µF
EC7BW-110D12	43-160 VDC	±12 VDC	0 mA	±833 mA	3 mA	204.3 mA	89	680µF
EC7BW-110D15	43-160 VDC	±15 VDC	0 mA	±667 mA	3 mA	205.4 mA	88.5	350µF

Derating Curve

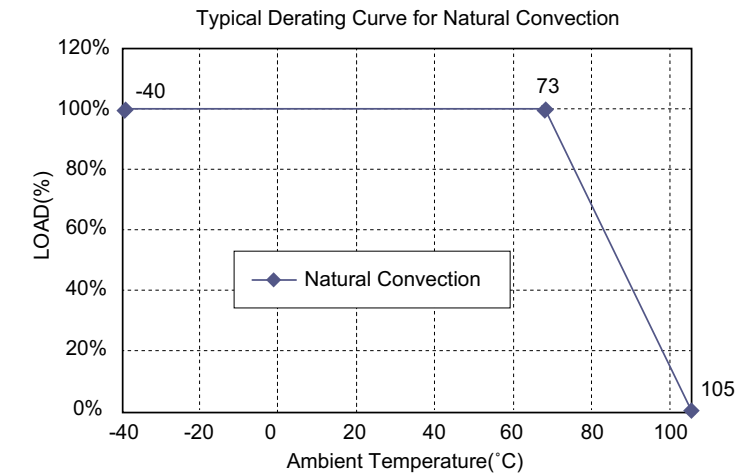

Specifications

All Specifications Typical At Nominal Line, Full Load, and 25°C Unless Otherwise Noted

INPUT SPECIFICATIONS

Input Voltage Range	110V	43-160V
Input Surge Voltage (100ms max.)	200Vdc max.	
Under Voltage Lockout	Power up	40V
	Power down	38V
Positive Logic Remote On/Off (note 4 & 5)		
Input Filter	Pi Type	

OUTPUT SPECIFICATIONS

Voltage Accuracy	±1.5% max.
Voltage Balance (Dual Output)	±1.0% max.
Transient Response: 25% Step Load Change	< 250µs
External Trim Adj. Range (Single Output Models Only)	±10%
Ripple & Noise, 20MHz BW (note 3)	5V 40mV RMS, max. 75mV pk-pk, max. 12V & 15V & ±12V & ±15V 40mV RMS, max. 100mV pk-pk, max.
Temperature Coefficient	±0.03%/°C
Short Circuit Protection	Continuous
Line Regulation (note 1)	±0.2% max.
Load Regulation (note 2)	Single ±0.5% max. Dual ±1.0% max.
Cross Regulation (Dual output)	±5.0% max.
Load cross variation 10%/100%	
Over Voltage Protection	Zener or TVS Clamp
Current Limit	110%-160% Nominal Output
Start up time	Single 15ms typ. Dual 25ms typ.

GENERAL SPECIFICATIONS

Efficiency	See Table
Isolation Voltage	Input/Output 2250VDC min.
Isolation Resistance	10 ⁹ ohm min.
Isolation Capacitance	1000pF typ.
Switching Frequency	250KHz typ.
EMI/RFI	Conductive EMI Meets EN55022 Class A
Operating Ambient Temperature	-40°C to +85°C
De-rating, Above 73°C	Linearly to Zero power at 105°C
Case Temperature	105°C max.
Storage Temperature	-55°C to +125°C
Humidity	95% RH max. Non condensing
MTBF MIL-HDBK-217F, GB, 25°C, Full Load	TBD hrs typ.
Safety	UL60950-1 2nd (Basic insulation)
EMC (note 6)	meet EN50155 (EN50121-3-2) with external filter
Shock/Vibration	meet EN50155 (EN61373)
Dimensions	2.00 x 1.00 x 0.40 inches (50.8 x 25.4 x 10.2 mm)
Case Material	Black Coated Copper with Non-Conductive Base
Weight	35 g

NOTE

1. Measured from high line to low line.
2. Measured from full load to zero load.
3. Output ripple and noise measured with 1µF ceramic capacitor across output.
4. Logic compatibility open collector ref. to -Input
Module On > 3.5VDC to 75VDC or open circuit
Module Off < 1.2VDC
5. Suffix "N" to the model number with negative logic remote on/off
Module On < 1.2VDC
Module Off > 3.5VDC to 75VDC or open circuit
6. Design meet EN50155 and RIA12 refer to application note.

EC9B SERIES

30 WATT, 2:1 INPUT RANGE

Visit www.cincon.com for new releases and a wider selection of products

Features

- ◆ 30W Isolated Output
- ◆ Efficiency to 92%
- ◆ 2" x 1" Six-Sided Shield Metal Case
- ◆ Fixed Switching Frequency
- ◆ 2 : 1 Input Range
- ◆ Regulated Outputs
- ◆ Input Under Voltage Protection
- ◆ Over Current Protection
- ◆ Remote On/Off
- ◆ Continuous Short Circuit Protection
- ◆ No Tantalum Capacitor Inside
- ◆ CE Mark Meets 2004/108/EC
- ◆ Safety Meets UL60950-1, EN60950-1, and IEC60950-1



Mechanical Dimensions

NOTE: Pin Size is 0.04±0.004 Inch (1.0±0.1 mm)DIA
All Dimensions in Inches (mm)
Tolerance Inches: X.XX=±0.04, X.XXX=±0.010
Millimeters: X.X=±0.5, X.XX=±0.25

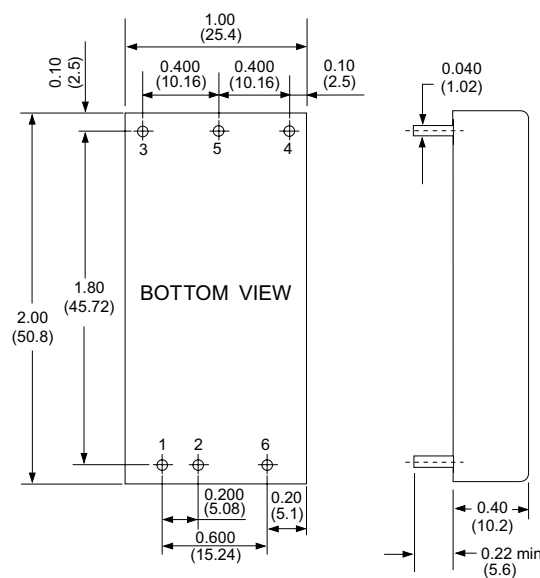

PIN CONNECTION		
PIN	Single Output	Dual Output
1	+V Input	+V Input
2	-V Input	-V Input
3	+V Output	+V Output
4	Trim	-V Output
5	-V Output	Common
6	Remote On/Off	

MODEL NUMBER	INPUT VOLTAGE	OUTPUT VOLTAGE	OUTPUT CURRENT		INPUT CURRENT		% EFF.	CAPACITOR LOAD MAX.
			MIN.	MAX.	NO LOAD	FULL LOAD		
EC9B-12S33	9-18 VDC	3.3 VDC	0 mA	7500 mA	170 mA	2371 mA	87	7500µF
EC9B-12S05	9-18 VDC	5 VDC	0 mA	6000 mA	150 mA	2841 mA	88	6000µF
EC9B-12S12	9-18 VDC	12 VDC	0 mA	2500 mA	55 mA	2732 mA	91.5	2500µF
EC9B-12S15	9-18 VDC	15 VDC	0 mA	2000 mA	80 mA	2762 mA	90.5	2000µF
EC9B-12D12	9-18 VDC	±12 VDC	0 mA	±1250 mA	55 mA	2793 mA	89.5	1250µF
EC9B-12D15	9-18 VDC	±15 VDC	0 mA	±1000 mA	60 mA	2778 mA	90	1000µF
EC9B-24S33	18-36 VDC	3.3 VDC	0 mA	7500 mA	110 mA	1172 mA	88	7500µF
EC9B-24S05	18-36 VDC	5 VDC	0 mA	6000 mA	90 mA	1389 mA	90	6000µF
EC9B-24S12	18-36 VDC	12 VDC	0 mA	2500 mA	50 mA	1359 mA	92	2500µF
EC9B-24S15	18-36 VDC	15 VDC	0 mA	2000 mA	80 mA	1374 mA	91	2000µF
EC9B-24D12	18-36 VDC	±12 VDC	0 mA	±1250 mA	40 mA	1366 mA	91.5	1250µF
EC9B-24D15	18-36 VDC	±15 VDC	0 mA	±1000 mA	40 mA	1366 mA	91.5	1000µF
EC9B-48S33	36-75 VDC	3.3 VDC	0 mA	7500 mA	70 mA	586 mA	88	7500µF
EC9B-48S05	36-75 VDC	5 VDC	0 mA	6000 mA	50 mA	698 mA	89.5	6000µF
EC9B-48S12	36-75 VDC	12 VDC	0 mA	2500 mA	30 mA	687 mA	91	2500µF
EC9B-48S15	36-75 VDC	15 VDC	0 mA	2000 mA	50 mA	691 mA	90.5	2000µF
EC9B-48D12	36-75 VDC	±12 VDC	0 mA	±1250 mA	40 mA	691 mA	90.5	1250µF
EC9B-48D15	36-75 VDC	±15 VDC	0 mA	±1000 mA	45 mA	691 mA	90.5	1000µF

Derating Curve

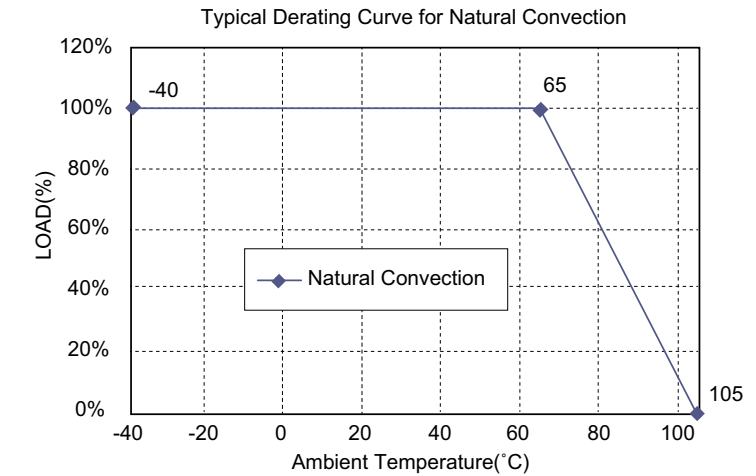

Specifications

All Specifications Typical At Nominal Line, Full Load, and 25°C Unless Otherwise Noted

INPUT SPECIFICATIONS

Input Voltage Range	12VDC9-18VDC 24VDC18-36VDC 48VDC36-75VDC
Input Surge Voltage (100ms max.)	12VDC 25VDC max. 24VDC50VDC max. 48VDC100VDC max.
Under Voltage Lockout	12Vin Power Up 8.8VDC typ. Power Down 8.0VDC typ. 24Vin Power Up 17VDC typ. Power Down 16VDC typ. 48Vin Power Up 34VDC typ. Power Down 32VDC typ.
Positive Logic Remote On/Off (note 3 & 4)	
Input Filter	PI Type

OUTPUT SPECIFICATIONS

Voltage Accuracy	±1.0% max.
Voltage Balance (Dual)	±1.0% max.
Transient Response: 75%-100% Step Load Change	
Error Band	±5% Vout nominal
Recovery Time	< 250µs
Ripple & Noise, 20MHz BW (Measured with 0.1µF MLCC)	
3.3V & 5V	75mV pk-pk max.
12V & 15V & ±12V & ±15V	100mV pk-pk max.
Temperature Coefficient	±0.03%/°C
Line Regulation (note 1)	±0.2% max.
Load Regulation (note 2)	±0.5% max.
	Dual ±1.0% max.
Cross Regulation (Dual Output)	
Load Cross Variation 10%/100%	±5% max.
Over Voltage Protection	Zener or TVS Clamp
Output Short Circuit Protection	Continuous
Output Current Limit, % Nominal Output	110%~150%
External Trim Adj. Range (Single Output Models Only)	±10%
Start Up Time	5ms typ.

GENERAL SPECIFICATIONS

Efficiency	See Table
Isolation Voltage	Input/Output 1500VDC max.
Isolation Resistance	10 ⁹ ohm min.
Isolation Capacitance	1000pF typ.
Switching Frequency	400KHz typ.
EMI/RFI	Six-Sided Continuous Shield
Operating Ambient Temperature	-40°C to +85°C
De-rating, Above 65°C	Linearly to Zero Power at 105°C
Case Temperature (note 5)	105°C max.
Cooling	Natural Convection
Storage Temperature	-55°C to +125°C
Thermal Shutdown, Case Temp.	110°C
Humidity	95% RH max. Non-Condensing
MTBF ... MIL-STD-217F, GB, 25°C, Full Load	
	Single 900Khrs typ.
	Dual 700Khrs typ.
Dimensions	2.00 x 1.00 x 0.40 inches (50.8 x 25.4 x 10.2 mm)
Case Material	Black Coated Copper with Non-Conductive Base
Weight	35 g

NOTE

1. Measured from high line to low line.
2. Measured from full load to 0% load.
3. Logic compatibility ... CMOS or open collector TTL, referenced to -Vin.
Module On >3.5VDC to 75VDC or open circuit
Module Off < 1.2VDC
4. Suffix "N" to the model number with negative logic remote on/off
Module On < 1.2VDC
Module Off >3.5VDC to 75VDC or open circuit
5. Maximum case temperature under any operating condition should not be exceeded 105°C.

EC9BW SERIES

30 WATT, 4:1 INPUT RANGE

Visit www.cincon.com for new releases and a wider selection of products

Features

- ◆ 30W Isolated Output
- ◆ Efficiency to 92%
- ◆ 2" x 1" Six-Sided Shield Metal Case
- ◆ 4 : 1 Input Range
- ◆ Regulated Outputs
- ◆ Fixed Switching Frequency
- ◆ Input Under Voltage Protection
- ◆ Over Current Protection
- ◆ Remote On/Off
- ◆ Continuous Short Circuit Protection
- ◆ No Tantalum Capacitor Inside
- ◆ CE Mark Meets 2004/108/EC
- ◆ Safety Meets UL60950-1, EN60950-1, and IEC60950-1



Mechanical Dimensions

NOTE: Pin Size is 0.04±0.004 Inch (1.0±0.1 mm)DIA
All Dimensions in Inches (mm)
Tolerance Inches: X.XX=±0.04, X.XXX=±0.010
Millimeters: X.X=±0.5, X.XX=±0.25

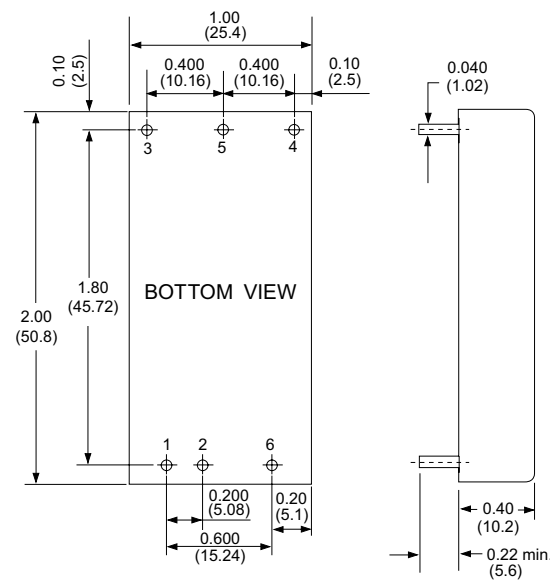

PIN CONNECTION		
PIN	Single Output	Dual Output
1	+V Input	+V Input
2	-V Input	-V Input
3	+V Output	+V Output
4	Trim	-V Output
5	-V Output	Common
6	Remote On/Off	

MODEL NUMBER	INPUT VOLTAGE	OUTPUT VOLTAGE	OUTPUT CURRENT		INPUT CURRENT		% EFF.	CAPACITOR LOAD MAX.
			MIN.	MAX.	NO LOAD	FULL LOAD		
EC9BW-24S33	9-36 VDC	3.3 VDC	0 mA	7500 mA	100 mA	1172 mA	88	7500µF
EC9BW-24S05	9-36 VDC	5 VDC	0 mA	6000 mA	110 mA	1397 mA	89.5	6000µF
EC9BW-24S12	9-36 VDC	12 VDC	0 mA	2500 mA	50 mA	1374 mA	91	2500µF
EC9BW-24S15	9-36 VDC	15 VDC	0 mA	2000 mA	50 mA	1374 mA	91	2000µF
EC9BW-24D12	9-36 VDC	±12 VDC	0 mA	±1250 mA	60 mA	1374 mA	91	1250µF
EC9BW-24D15	9-36 VDC	±15 VDC	0 mA	±1000 mA	60 mA	1359 mA	92	1000µF
EC9BW-48S33	18-75 VDC	3.3 VDC	0 mA	7500 mA	50 mA	593 mA	87	7500µF
EC9BW-48S05	18-75 VDC	5 VDC	0 mA	6000 mA	50 mA	694 mA	89.5	6000µF
EC9BW-48S12	18-75 VDC	12 VDC	0 mA	2500 mA	30 mA	683 mA	91.5	2500µF
EC9BW-48S15	18-75 VDC	15 VDC	0 mA	2000 mA	30 mA	679 mA	92	2000µF
EC9BW-48D12	18-75 VDC	±12 VDC	0 mA	±1250m A	40 mA	683 mA	91.5	1250µF
EC9BW-48D15	18-75 VDC	±15 VDC	0 mA	±1000m A	40 mA	679 mA	92	1000µF

Derating Curve

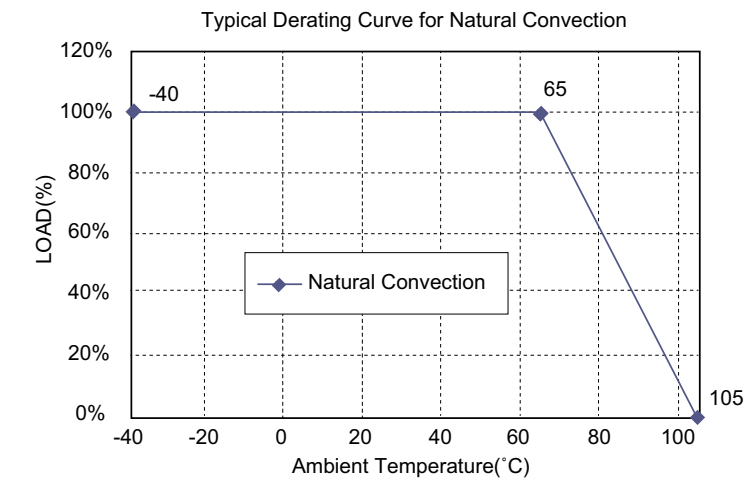

Specifications

All Specifications Typical At Nominal Line, Full Load, and 25°C Unless Otherwise Noted

INPUT SPECIFICATIONS

Input Voltage Range	24VDC 9-36VDC
	48VDC 18-75VDC
Input Surge Voltage (100ms max.)	24VDC 50VDC max.
	48VDC 100VDC max.
Under Voltage Lockout	24Vin
	Power Up.....8.8VDC typ.
	Power Down.....8.0VDC typ.
	48Vin
	Power Up.....17VDC typ.
	Power Down.....16VDC typ.
Input Filter	PI Type
Positive Logic Remote on/off Control (note 3 & 4)	

OUTPUT SPECIFICATIONS

Voltage Accuracy	±1% max.
Voltage Balance (Dual)	±1% max.
Transient Response: 75% - 100% Step Load Change	
Error Band	±5% Vout nominal,
Recovery Time	< 250µs
Ripple & Noise, 20MHz BW	
(Measured with 0.1µF MLCC)	
Vo=3.3 & 5V	75mV pk-pk max.
Vo=12V & 15V & ±12V & ±15V	100mV pk-pk max.
Temperature Coefficient	±0.02%/°C
Line Regulation (note 1)	Single
	Dual
	±0.2% max.
Load Regulation (note 2)	Single
	Dual
	±0.5% max.
	±1.0% max.
Cross Regulation (Dual Output)	
Load Cross Variation 10%/100%	±5% max.
Over Voltage Protection	Zener or TVS Clamp
Current Limit	110% - 160% Nominal Output
Output Short Circuit Protection	Continuous (Hiccup Mode)
External Trim Adj. Range	
(Single Output Models Only)	±10%
Start Up Time	5ms typ.

GENERAL SPECIFICATIONS

Efficiency	See Table
Isolation Voltage	1500 VDC min.
Isolation Resistance	10 ⁹ ohm min.
Isolation Capacitance	1000pF typ.
Switching Frequency	430KHz typ.
EMI/RFI	Six-Sided Continuous Shield
Operating Ambient Temperature Range	-40°C to +85°C
De-rating, Above 65°C	Linearly to Zero Power at +105°C
Case Temperature (note 5)	105°C max.
Cooling	Natural Convection
Storage Temperature Range	-55°C to +125°C
Thermal Shutdown, Case Temp.	110°C typ.
Humidity	95% RH max. Non-Condensing
MTBF ... MIL-STD-217F, GB, 25°C, Full Load	
	Single
	Dual
	900Khrs typ.
	650Khrs typ.
Dimensions	2.00 x 1.00 x 0.40 inches
	(50.8 x 25.4 x 10.2 mm)
Case Material	Black Coated Copper with Non-Conductive Base
Weight	35 g

NOTE

1. Measured from high line to low line.
2. Measured from full load to min. load.
3. Logic compatibility CMOS or open collector TTL, referenced to -Vin.
Module On >3.5VDC to 75VDC or open circuit
Module Off <1.2VDC
4. Suffix "N" to the model number with negative logic remote on/off
Module On <1.2VDC
Module Off >3.5VDC to 75VDC or open circuit
5. Maximum case temperature under any operating condition should not be exceeded 105°C.

ECLB40W SERIES

40 WATT, 4:1 INPUT RANGE

Visit www.cincon.com for new releases and a wider selection of products

Features

- ◆ 40W Isolated Output
- ◆ Efficiency to 91%
- ◆ 2.05" x 1.2" x 0.4" Six-Sided Shield Metal Case
- ◆ 4 : 1 Input Range
- ◆ Regulated Outputs
- ◆ Fixed Switching Frequency
- ◆ Low No Load Power Consumption
- ◆ Input Under Voltage Protection
- ◆ Over Current Protection
- ◆ Remote On/Off
- ◆ Continuous Short Circuit Protection
- ◆ No Tantalum Capacitor Inside
- ◆ CE Mark Meets 2004/108/EC
- ◆ Safety Meets UL60950-1, EN60950-1, and IEC60950-1



Mechanical Dimensions

NOTE: Pin Size is 0.04±0.004 Inch (1.0±0.1 mm)DIA
All Dimensions in Inches (mm)
Tolerance Inches: X.XX=±0.04, X.XXX=±0.010
Millimeters: X.X=±0.5, X.XX=±0.25

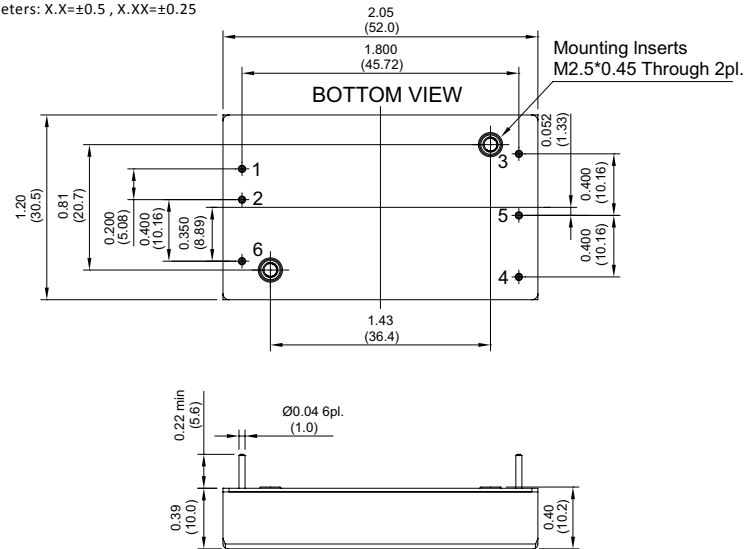

PIN CONNECTION		
PIN	Single Output	Dual Output
1	+V Input	+V Input
2	-V Input	-V Input
3	+V Output	+V Output
4	Trim	-V Output
5	-V Output	Common
6	Remote On/Off	

MODEL NUMBER	INPUT VOLTAGE	OUTPUT VOLTAGE	OUTPUT CURRENT		INPUT CURRENT		% EFF.	CAPACITOR LOAD MAX.
			MIN.	MAX.	NO LOAD	FULL LOAD		
ECLB40W-24S33	9-36 VDC	3.3 VDC	0 mA	10000 mA	8 mA	1528 mA	90	10000µF
ECLB40W-24S05	9-36 VDC	5 VDC	0 mA	8000 mA	8 mA	1842 mA	90.5	8000µF
ECLB40W-24S12	9-36 VDC	12 VDC	0 mA	3333 mA	10 mA	1832 mA	91	3300µF
ECLB40W-24S15	9-36 VDC	15 VDC	0 mA	2666 mA	10 mA	1842 mA	90.5	2700µF
ECLB40W-24D12	9-36 VDC	±12 VDC	0 mA	±1667 mA	10 mA	1873 mA	89	1650µF
ECLB40W-24D15	9-36 VDC	±15 VDC	0 mA	±1333 mA	10 mA	1862 mA	89.5	1350µF
ECLB40W-48S33	18-75 VDC	3.3 VDC	0 mA	10000 mA	6 mA	764 mA	90	10000µF
ECLB40W-48S05	18-75 VDC	5 VDC	0 mA	8000 mA	6 mA	921 mA	90.5	8000µF
ECLB40W-48S12	18-75 VDC	12 VDC	0 mA	3333 mA	8 mA	921 mA	90.5	3300µF
ECLB40W-48S15	18-75 VDC	15 VDC	0 mA	2666 mA	8 mA	921 mA	90.5	2700µF
ECLB40W-48D12	18-75 VDC	±12 VDC	0 mA	±1667 mA	8 mA	932 mA	89.5	1650µF
ECLB40W-48D15	18-75 VDC	±15 VDC	0 mA	±1333 mA	8 mA	926 mA	90	1350µF

Derating Curve

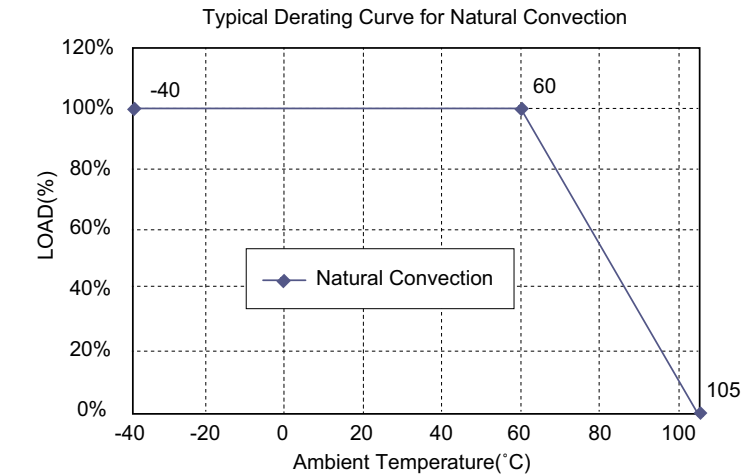

Specifications

All Specifications Typical At Nominal Line, Full Load, and 25°C Unless Otherwise Noted

INPUT SPECIFICATIONS

Input Voltage Range	24VDC.....9-36VDC 48VDC.....18-75VDC
Input Surge Voltage (100ms max.)	24VDC.....50VDC max. 48VDC.....100VDC max.
Under Voltage Lockout	24VIn Power Up.....8.5VDC typ. Power Down.....8.0VDC typ. 48VIn Power Up.....17VDC typ. Power Down.....16VDC typ.
Input Filter	PI Type

OUTPUT SPECIFICATIONS

Voltage Accuracy	±1.5% max.
Voltage Balance (Dual)	±1% max.
Transient Response: 75% - 100% Step Load Change	
Error Band	±5% Vout nominal
Recovery Time	< 250µs
Ripple & Noise, 20MHz BW (Measured with 1µF MLCC)	
Vo=3.3 & 5V	100mV pk-pk max.
Vo=12V & 15V & ±12V & ±15V	150mV pk-pk max.
Temperature Coefficient	±0.02%/°C max.
Line Regulation (note 1)	±0.2% max.
Load Regulation (note 2)	±0.5% max.
Cross Regulation (Dual Output)	
Load Cross Variation 10%/100%	±5% max.
Over Voltage Protection	Zener or TVS Clamp
Current Limit	110% - 160% Nominal Output
Output Short Circuit Protection	Continuous (Hiccup Mode)
External Trim Adj. Range (Single Output Models Only)	±10%
Start Up Time	15ms typ.

GENERAL SPECIFICATIONS

Efficiency	See Table
Isolation Voltage	Input/Output.....1500VDC min. Input/Case, Output/Case.....1000VDC min. 10 ⁹ ohm min.
Isolation Resistance	Input/Output.....1500pF typ. Input/Case.....1000pF typ. Output/Case.....1000pF typ.
Isolation Capacitance	300KHz typ. Six-Sided Continuous Shield
Switching Frequency	-40°C to +85°C
EMI/RFI	Linearly to Zero Power at +105°C
Operating Ambient Temperature Range	105°C max.
De-rating, Above 60°C	Natural Convection
Case Temperature (note 4)	-55°C to +125°C
Cooling	110°C typ.
Storage Temperature Range	95% RH max. Non-Condensing
Thermal Shutdown, Case Temp.	1400Khrs typ.
Humidity	2.05 x 1.20 x 0.40 inches (52 x 30.5 x 10.2 mm)
MTBF MIL-STD-217F, GB, 25°C, Full Load	Aluminum with Non-Conductive Base
Dimensions	Base
Case Material	Weight
Weight	36 g

NOTE

1. Measured from high line to low line.
2. Measured from full load to min. load.
3. Logic compatibility ... CMOS or open collector TTL, refer to -Vin.
Module On >3.5VDC to 75VDC or open circuit
Module Off < 1.2VDC
4. Maximum case temperature under any operating condition should not be exceeded 105°C.

ECLB40W-110 SERIES

40 WATT, INPUT RANGE 43-160 VDC

Visit www.cincon.com for new releases and a wider selection of products

Features

- ◆ 40W Isolated Output
- ◆ Efficiency to 91%
- ◆ 2.05" x 1.2" x 0.4" Six-Sided Shield Metal Case
- ◆ 4 : 1 Input Range
- ◆ Regulated Outputs
- ◆ Fixed Switching Frequency
- ◆ Input Under Voltage Protection
- ◆ Over Current Protection
- ◆ Remote On/Off
- ◆ Low No Load Power Consumption
- ◆ Continuous Short Circuit Protection
- ◆ No Tantalum Capacitor Inside
- ◆ Safety standard: UL 60950-1 2nd (basic insulation)
- ◆ EMC: EN 50155 (EN 50121-3-2), external filter required
- ◆ Shock & Vibration: EN 50155 (EN 61373)



Mechanical Dimensions

NOTE: Pin Size is 0.04±0.004 Inch (1.0±0.1 mm) DIA
All Dimensions in Inches (mm)
Tolerance Inches: X.XX=±0.02, X.XXX=±0.010
Millimeters: X.X=±0.5, X.XX=±0.25

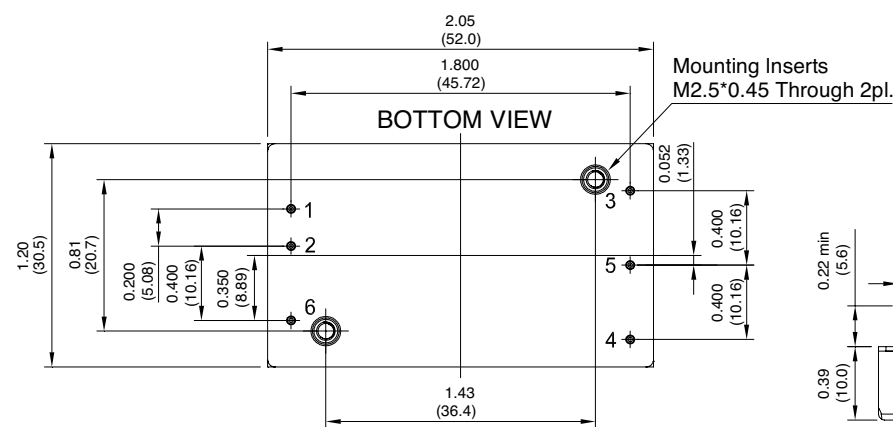

PIN CONNECTION		
PIN	Single Output	Dual Output
1	+V Input	+V Input
2	-V Input	-V Input
3	+V Output	+V Output
4	Trim	-V Output
5	-V Output	Common
6	Remote On/Off	

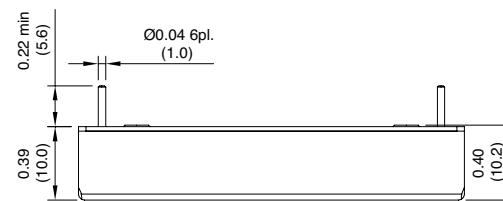

MODEL NUMBER	INPUT VOLTAGE	OUTPUT VOLTAGE	OUTPUT CURRENT		INPUT CURRENT		% EFF.	CAPACITOR LOAD MAX.
			MIN.	MAX.	NO LOAD	FULL LOAD		
ECLB40W-110S33	43-160 VDC	3.3 VDC	0 mA	10000 mA	6 mA	340 mA	88%	10000µF
ECLB40W-110S05	43-160 VDC	5 VDC	0 mA	8000 mA	6 mA	409 mA	88.5%	8000µF
ECLB40W-110S12	43-160 VDC	12 VDC	0 mA	3333 mA	6 mA	404 mA	90%	3300µF
ECLB40W-110S15	43-160 VDC	15 VDC	0 mA	2666 mA	6 mA	399 mA	91%	2700µF
ECLB40W-110D12	43-160 VDC	±12 VDC	0 mA	±1667 mA	6 mA	408 mA	88%	1650µF
ECLB40W-110D15	43-160 VDC	±15 VDC	0 mA	±1333 mA	6 mA	408 mA	88.5%	1350µF
ECLB40W-110D24	43-160 VDC	±24 VDC	0 mA	±833 mA	6 mA	408 mA	89%	850µF

Derating Curve

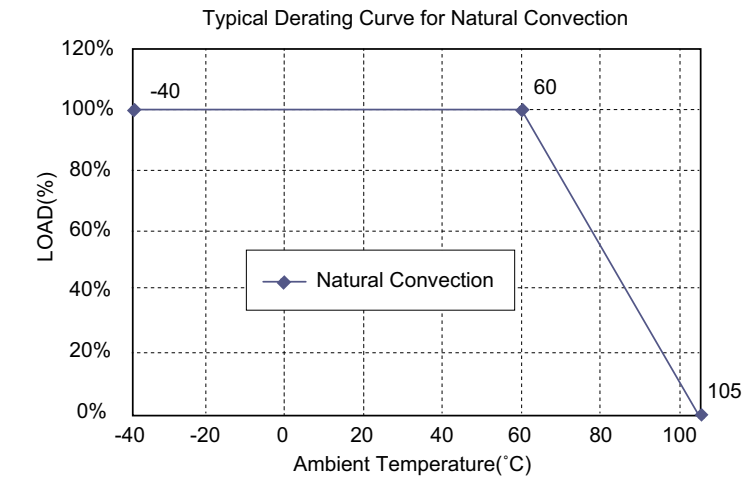

Specifications

All Specifications Typical At Nominal Line, Full Load, and 25°C Unless Otherwise Noted

INPUT SPECIFICATIONS

Input Voltage Range 43-160V
Input Surge Voltage (100ms max.) 200Vdc max.
Under Voltage Lockout Power up 40V
Power down 38V

Positive Logic Remote On/Off (note 4 & 5)
Input Filter PI Type

OUTPUT SPECIFICATIONS

Voltage Accuracy ±1.5% max.
Voltage Balance (Dual Output) ±1.0% max.
Transient Response: 25% Step Load Change Error Band +/-5% Vout Nominal, Recovery Time < 250µs

External Trim Adj. Range (Single Output Models Only) ±10%
Ripple & Noise, 20MHz BW (Measured with 1µF MLCC)
Vo = 3.3V & 5V 100mV pk-pk max.
Vo = 12V, 15V, ±12V & ±15V 150mV pk-pk max.
Vo = ±24V 200mV pk-pk max.

Temperature Coefficient ±0.02%/°C max.
Short Circuit Protection Continuous
Line Regulation (note 1) ±0.2% max.
Load Regulation (note 2) Single ±0.5% max., Dual ±1.0% max.
Cross Regulation (Dual output) Load cross variation 10%/100% ±5.0% max.
Over Voltage Protection Zener or TVS Clamp
Current Limit 110%-160% Nominal Output
Start up time 15ms typ.

NOTE

1. Measured from high line to low line.
2. Measured from full load to zero load.
3. Logic Compatibility ... CMOS or Open Collector TTL, Referenced to -Vin.
Module On >3.5VDC to 75VDC or Open Circuit
Module Off <1.2VDC

GENERAL SPECIFICATIONS

Efficiency See Table
Isolation Voltage Input/Output 2250VDC min.
Input/Case 1600VDC min.
Output/Case 1600VDC min.
10⁹ ohms min.
1500pF typ.
Output/case 1000pF typ.
Switching Frequency 250KHz typ.
EMI/RFI Six-Sided Continuous Shield
Operating Ambient Temperature Range -40°C to +85°C
De-rating, Above 60° Linearly to Zero Power at +105°C
Case Temperature (note 5) 105°C max.
Cooling Natural Convection
Storage Temperature Range -55°C to +125°C
Thermal Shutdown, Case Temp 110°C typ.
Humidity 95% RH max. Non-Condensing
MTBFMIL-STD-217F, GB, 25°C, Full Load 905Khrs typ.
Safety UL60950-1 2nd (Basic insulation)
EMC (note 6) EN50155 (EN50121-3-2) with external filter
EN50155 (EN61373)
Shock/Vibration EN50155 (EN61373)
Dimensions 2.05 x 1.20 x 0.40 inches (52.0 x 30.5 x 10.2 mm)
Case Material Aluminum with Non-Conductive Base
Weight 36 g

4. Suffix "N" to the model number with negative logic remote On/Off
Module On< 1.2VDC
Module Off>3.5VDC to 75VDC or Open Circuit
5. Maximum case temperature under any operating condition should not be exceeded 105°C.
6. Design meet EN50155 and RIA12 refer to application note.

ECLB60 SERIES

60 WATT, 2:1 INPUT RANGE

Visit www.cincon.com for new releases and a wider selection of products

Features

- ◆ 60W Isolated Output
- ◆ Efficiency to 93.5%
- ◆ 2.05" x 1.2" x 0.4" Six-Sided Shield Metal Case
- ◆ 2 : 1 Input Range
- ◆ Regulated Outputs
- ◆ Fixed Switching Frequency
- ◆ Input Under Voltage Protection
- ◆ Over Current Protection
- ◆ Remote On/Off
- ◆ Low No Load Power Consumption
- ◆ Continuous Short Circuit Protection
- ◆ No Tantalum Capacitor Inside
- ◆ CE Mark Meets 2004/108/EC
- ◆ Safety Meets UL60950-1, EN60950-1, and IEC60950-1
- ◆ Full Load Operation Up to 60°C with Heat-Sink M-C655



Mechanical Dimensions

CASE LB
All Dimensions in Inches (mm)
Tolerance Inches: X.XX=±0.02, X.XXX=±0.010
Millimeters: X.X=±0.5, X.XX=±0.25

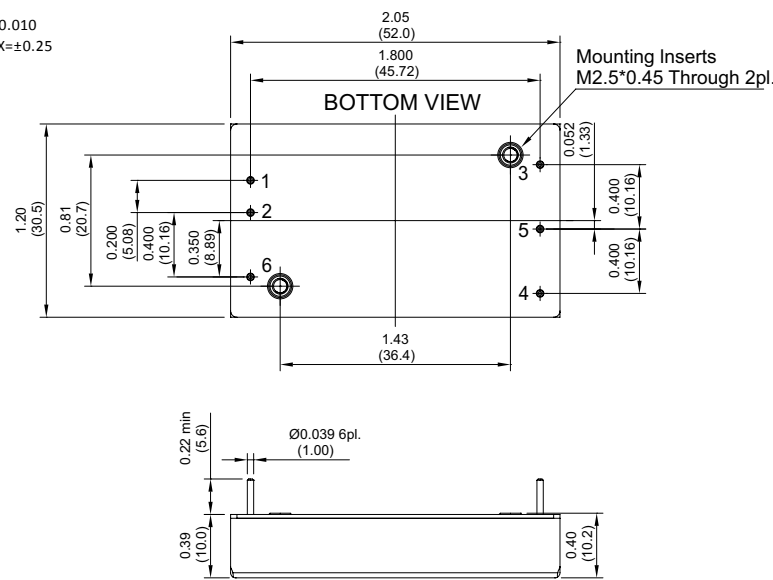

PIN CONNECTION	
PIN	Single Output
1	+V Input
2	-V Input
3	+V Output
4	Trim
5	-V Output
6	Remote On/Off

MODEL NUMBER	INPUT VOLTAGE	OUTPUT VOLTAGE	OUTPUT CURRENT		INPUT CURRENT		% EFF.	CAPACITOR LOAD MAX.
			MIN.	MAX.	NO LOAD	FULL LOAD		
ECLB60-12S33	9-18 VDC	3.3 VDC	0 mA	15 A	10 mA	4.59 A	90.5	15000µF
ECLB60-12S05	9-18 VDC	5 VDC	0 mA	12 A	10 mA	5.50 A	91.5	12000µF
ECLB60-12S12	9-18 VDC	12 VDC	0 mA	5 A	10 mA	5.45 A	92.5	5000µF
ECLB60-12S15	9-18 VDC	15 VDC	0 mA	4 A	10 mA	5.45 A	92.5	4000µF
ECLB60-24S33	18-36 VDC	3.3 VDC	0 mA	15 A	8 mA	2.28 A	91	15000µF
ECLB60-24S05	18-36 VDC	5 VDC	0 mA	12 A	8 mA	2.72 A	92.5	12000µF
ECLB60-24S12	18-36 VDC	12 VDC	0 mA	5 A	8 mA	2.69 A	93.5	5000µF
ECLB60-24S15	18-36 VDC	15 VDC	0 mA	4 A	8 mA	2.69 A	93.5	4000µF
ECLB60-48S33	36-75 VDC	3.3 VDC	0 mA	15 A	5 mA	1.14 A	91	15000µF
ECLB60-48S05	36-75 VDC	5 VDC	0 mA	12 A	5 mA	1.36 A	92	12000µF
ECLB60-48S12	36-75 VDC	12 VDC	0 mA	5 A	5 mA	1.35 A	93	5000µF
ECLB60-48S15	36-75 VDC	15 VDC	0 mA	4 A	5 mA	1.35 A	93	4000µF

Derating Curve

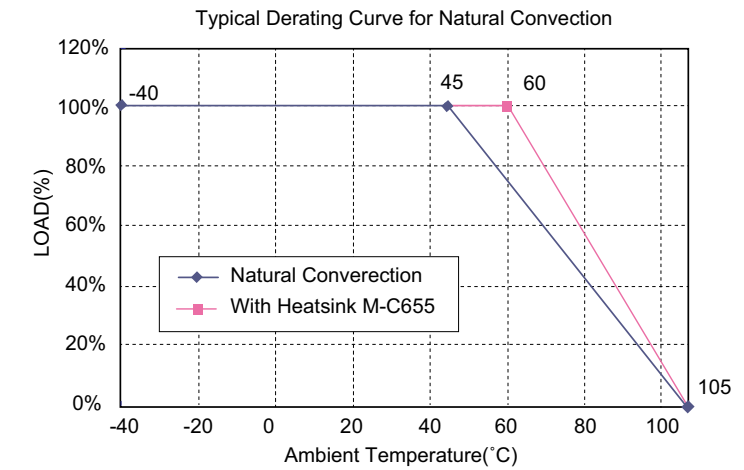

Specifications

All Specifications Typical At Nominal Line, Full Load, and 25°C Unless Otherwise Noted

INPUT SPECIFICATIONS

Input Voltage Range	12VDC 9-18VDC 24VDC 18-36VDC 48VDC 36-75VDC
Input Surge Voltage (100ms max.)	12VDC 25VDC max. 24VDC 50VDC max. 48VDC 100VDC max.
Under Voltage Lockout	12Vin Power Up.....8.5VDC typ. Power Down.....8VDC typ. 24Vin Power Up.....17VDC typ. Power Down.....16VDC typ. 48Vin Power Up.....34VDC typ. Power Down.....32VDC typ.
Positive Logic Remote On/Off Control (note 3 & 4).	
Input Filter	Pi Type

OUTPUT SPECIFICATIONS

Voltage Accuracy	±1.5% max.
Transient Response: 75% ~ 100% Step Load Change	
Error Band	±5% Vout nominal
Recovery Time	< 250µs
Ripple & Noise, 20MHz BW (Measured with 1µF MLCC)	
Vo=3.3 & 5V	100mV pk-pk max.
Vo=12V & 15V	150mV pk-pk max.
Temperature Coefficient	±0.02%/C
Line Regulation (note1)	±0.2% max.
Load Regulation (note2)	±0.5% max.
Over Voltage Protection	Zener or TVS Clamp
Current Limit	110% - 150% Nominal Output
Output Short Circuit Protection	Continuous (Hiccup Mode)
External Trim Adj. Range (Single Output Models Only)	±10%
Start up time	30ms typ.

GENERAL SPECIFICATIONS

Efficiency	See Table
Isolation Voltage	Input/Output.....1500VDC min. Input/Case, Output/Case.....1000VDC min.
Isolation Resistance	10 ⁹ ohm min.
Isolation Capacitance	Input/Output.....1500pF typ. Input/Case, Output/Case.....1000pF typ.
Switching Frequency	260KHz typ.
EMI/RFI	Six-Sided Continuous Shield
Operating Ambient Temperature Range	-40°C to +85°C
De-rating, Above 45°C	Linearly to Zero Power at +105°C
Case Temperature (note 5)	105°C
Cooling	Natural Convection
Storage Temperature Range	-55°C to +125°C
Thermal Shutdown Case Temp	110°C typ.
Humidity	95% RH max. Non-Condensing
MTBF.....MIL-STD-217F, GB, 25°C, Full Load	XXS05, XXS12 ... 900Khrs typ. Others1100Khrs typ.
Dimensions	2.05 x 1.20 x 0.40 inches (52.0 x 30.5 x 10.2 mm)
Case Material	Aluminum with Non-Conductive Base
Weight	39 g

NOTE

1. Measured from high line to low line.
2. Measured from full load to min. load.
3. Logic compatibility ... CMOS or open collector TTL, referenced to -Vin.
Module On >3.5VDC to 75VDC or open circuit
Module Off < 1.2VDC
4. Suffix "N" to the model number with negative logic remote On/Off
Module On < 1.2VDC
Module Off >3.5VDC to 75VDC or open circuit
5. Maximum case temperature under any operating condition should not be exceeded 105°C.

ECLB60W SERIES

60 WATT, 4:1 INPUT RANGE

Visit www.cincon.com for new releases and a wider selection of products

Features

- ◆ 60W Isolated Output
- ◆ Efficiency to 92.5%
- ◆ Low No Load Power Consumption
- ◆ 2.05" x 1.2" x 0.4" Six-Sided Shield Metal Case
- ◆ 4 : 1 Input Range
- ◆ Regulated Outputs
- ◆ Fixed Switching Frequency
- ◆ Input Under Voltage Protection
- ◆ Over Current Protection
- ◆ Remote On/Off
- ◆ Continuous Short Circuit Protection
- ◆ No Tantalum Capacitor Inside
- ◆ CE Mark Meets 2004/108/EC
- ◆ Safety Meets UL60950-1, EN60950-1, and IEC60950-1
- ◆ Full Load Operation Up to 55°C with Heat-Sink M-C655 Natural Convection



Mechanical Dimensions

NOTE: Pin Size is 0.04±0.004 Inch (1.0±0.1 mm)DIA
All Dimensions in Inches (mm)
Tolerance Inches: X.XX±0.02, X.XXX±0.010
Millimeters: X.X±0.5, X.XX±0.25

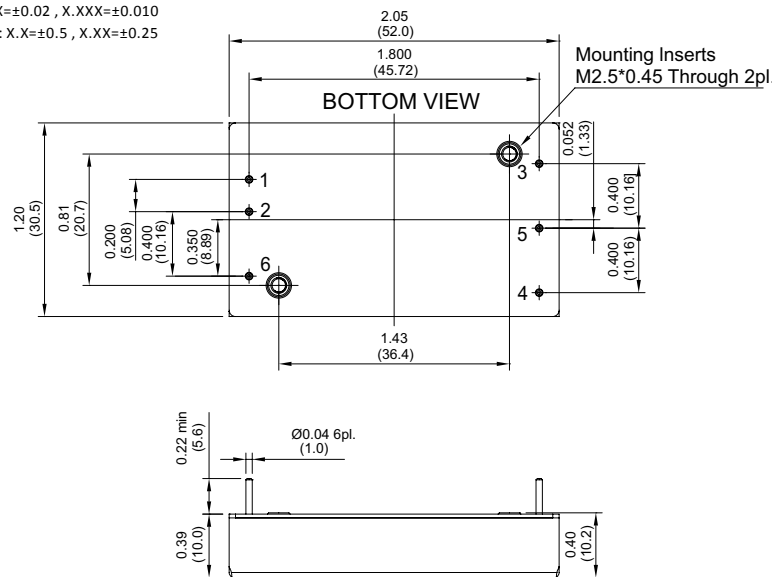

PIN CONNECTION		
PIN	Single Output	Dual Output
1	+V Input	+V Input
2	-V Input	-V Input
3	+V Output	+V Output
4	Trim	-V Output
5	-V Output	Common
6	Remote On/Off	

MODEL NUMBER	INPUT VOLTAGE	OUTPUT VOLTAGE	OUTPUT CURRENT		INPUT CURRENT		% EFF.	CAPACITOR LOAD MAX.
			MIN.	MAX.	NO LOAD	FULL LOAD		
ECLB60W-24S33	9-36 VDC	3.3 VDC	0 mA	15000 mA	10 mA	2279 mA	90	15000µF
ECLB60W-24S05	9-36 VDC	5 VDC	0 mA	12000 mA	10 mA	2717 mA	92	12000µF
ECLB60W-24S12	9-36 VDC	12 VDC	0 mA	5000 mA	10 mA	2717 mA	92	5000µF
ECLB60W-24S15	9-36 VDC	15 VDC	0 mA	4000 mA	10 mA	2717 mA	91	4000µF
ECLB60W-24D12	9-36 VDC	±12 VDC	0 mA	±2500 mA	12 mA	2747 mA	91	2500µF
ECLB60W-24D15	9-36 VDC	±15 VDC	0 mA	±2000 mA	12 mA	2747 mA	91	2000µF
ECLB60W-48S33	18-75 VDC	3.3 VDC	0 mA	15000 mA	8 mA	1140 mA	90.5	15000µF
ECLB60W-48S05	18-75 VDC	5 VDC	0 mA	12000 mA	8 mA	1359 mA	92	12000µF
ECLB60W-48S12	18-75 VDC	12 VDC	0 mA	5000 mA	8 mA	1359 mA	92	5000µF
ECLB60W-48S15	18-75 VDC	15 VDC	0 mA	4000 mA	8 mA	1359 mA	91	4000µF
ECLB60W-48D12	18-75 VDC	±12 VDC	0 mA	±2500 mA	8 mA	1374 mA	91	2500µF
ECLB60W-48D15	18-75 VDC	±15 VDC	0 mA	±2000 mA	8 mA	1374 mA	91	2000µF

Derating Curve

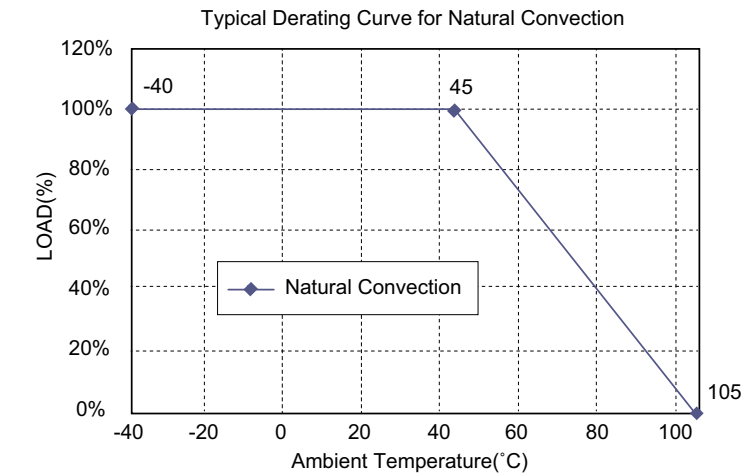

Specifications

All Specifications Typical At Nominal Line, Full Load, and 25°C Unless Otherwise Noted

INPUT SPECIFICATIONS

Input Voltage Range	24VDC 9-36VDC
	48VDC 18-75VDC
Input Surge Voltage (100ms max.)	24VDC 50VDC max.
	48VDC 100VDC max.
Under Voltage Lockout	24Vin
	48Vin
Input Filter	
Remote On/Off Control (note 3)	

OUTPUT SPECIFICATIONS

Voltage Accuracy	±1.5% max.
Voltage Balance (Dual)	±1% max.
Transient Response: 75% - 100% Step Load Change	
Error Band	±5% Vout nominal
Recovery Time	< 250µs
Ripple & Noise, 20MHz BW (Measured with 1µF MLCC)	
Vo=3.3 & 5V	100mV pk-pk max.
Vo=12V & 15V & ±12V & ±15V	150mV pk-pk max.
Temperature Coefficient	±0.02%/°C max.
Line Regulation (note 1)	±0.2% max.
Load Regulation (note 2)	±0.5% max.
Cross Regulation (Dual Output)	
Load Cross Variation 10%/100%	±5% max.
Over Voltage Protection	Zener or TVS Clamp
Current Limit	110% - 160% Nominal Output
Output Short Circuit Protection	Continuous (Hiccup Mode)
External Trim Adj. Range (Single Output Models Only)	±10%
Start Up Time	30ms typ.

GENERAL SPECIFICATIONS

Efficiency	See Table
Isolation Voltage	Input/Output 1500VDC min.
	Case 1000VDC min.
Isolation Resistance	10 ⁹ ohm min.
Isolation Capacitance	Input/Output 1500pF typ.
	Output/Case 1000pF typ.
Switching Frequency	Single 245KHz typ.
	Dual 300KHz typ.
EMI/RFI	Six-Sided Continuous Shield
Operating Ambient Temperature Range	-40°C to +85°C
De-rating, Above 45°C	Linearly to Zero Power at +105°C
Case Temperature (note 4)	105°C max.
Cooling	Natural Convection
Storage Temperature Range	-55°C to +125°C
Thermal Shutdown, Case Temp.	110°C typ.
Humidity	95% RH max. Non-Condensing
MTBF ... MIL-STD-217F, GB, 25°C, Full Load	Single 872Khrs typ.
	Dual 859Khrs typ.
Dimensions	2.05 x 1.20 x 0.40 inches (52 x 30.5 x 10.2 mm)
Case Material	Aluminum with Non-Conductive Base
Weight	39 g

NOTE

1. Measured from high line to low line.
2. Measured from full load to min. load.
3. Logic compatibility ... CMOS or open collector TTL, referenced to -Vin.
Module On >3.5VDC to 75VDC or open circuit
Module Off < 1.2VDC
4. Maximum case temperature under any operating condition should not be exceeded 105°C.

EC1SC SERIES

20 WATT, 4:1 INPUT RANGE

Visit www.cincon.com for new releases and a wider selection of products

Features

- ◆ 20W Isolated Output
- ◆ 2" x 1.6" Six-Sided Shield Metal Case
- ◆ Efficiency to 84%
- ◆ 4 : 1 Input Range
- ◆ Pi Input Filter
- ◆ Continuous Short Circuit Protection
- ◆ Meets EN55022 Class A, Conducted
- ◆ Remote On/Off Control
- ◆ CE Mark Meets 2004/108/EC
- ◆ UL60950-1 Approval

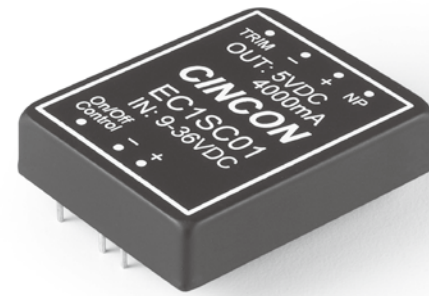

Mechanical Dimensions

All Dimensions in Inches (mm)
 Tolerance Inches: X.XX=±0.04, X.XXX=±0.010
 Millimeters: X.X=±0.5, X.XX=±0.25

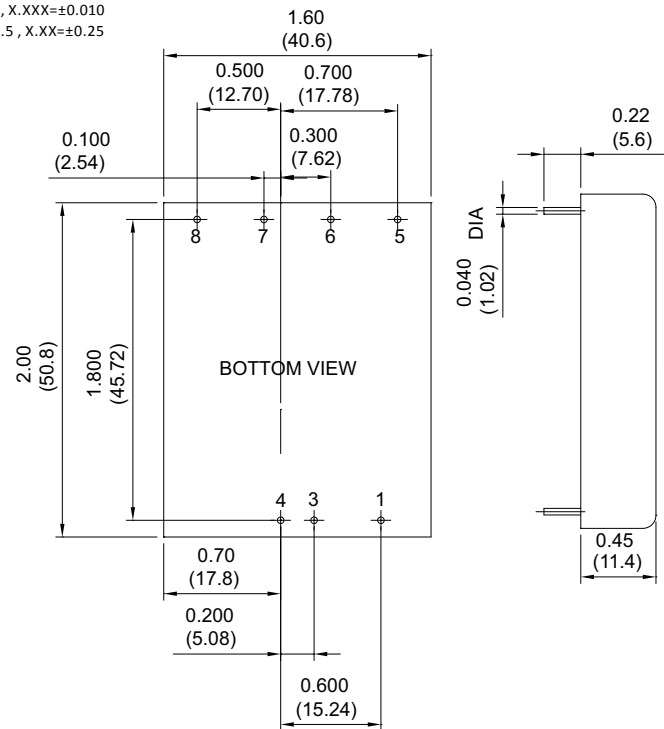

PIN CONNECTION		
PIN	Single Output	Dual Output
1	On/Off Control	On/Off Control
3	-V Input	-V Input
4	+V Input	+V Input
5	Trim	Trim
6	-V Output	-V Output
7	+V Output	Common
8	No Pin	+V Output

MODEL NUMBER	INPUT VOLTAGE	OUTPUT VOLTAGE	OUTPUT CURRENT	INPUT CURRENT		% EFF.	CASE
				NO LOAD	FULL LOAD		
EC1SC01	9-36 VDC	5 VDC	4000 mA	15 mA	1029 mA	81	4000µF
EC1SC02	9-36 VDC	12 VDC	1670 mA	15 mA	1006 mA	83	1670µF
EC1SC03	9-36 VDC	15 VDC	1330 mA	15 mA	1004 mA	83	1330µF
EC1SC04	9-36 VDC	±12 VDC	±833 mA	20 mA	1004 mA	83	833µF
EC1SC05	9-36 VDC	±15 VDC	±666 mA	20 mA	1004 mA	83	666µF
EC1SC06	9-36 VDC	±5 VDC	±2000 mA	20 mA	1004 mA	83	2000µF
EC1SC07	9-36 VDC	3.3 VDC	4000 mA	15 mA	705 mA	78	4000µF
EC1SC11	18-72 VDC	5 VDC	4000 mA	10 mA	508 mA	82	4000µF
EC1SC12	18-72 VDC	12 VDC	1670 mA	10 mA	497 mA	84	1670µF
EC1SC13	18-72 VDC	15 VDC	1330 mA	10 mA	496 mA	84	1330µF
EC1SC14	18-72 VDC	±12 VDC	±833 mA	15 mA	496 mA	84	833µF
EC1SC15	18-72 VDC	±15 VDC	±666 mA	15 mA	496 mA	84	666µF
EC1SC16	18-72 VDC	±5 VDC	±2000 mA	15 mA	496 mA	84	2000µF
EC1SC17	18-72 VDC	3.3 VDC	4000 mA	10 mA	353 mA	78	4000µF

Derating Curve

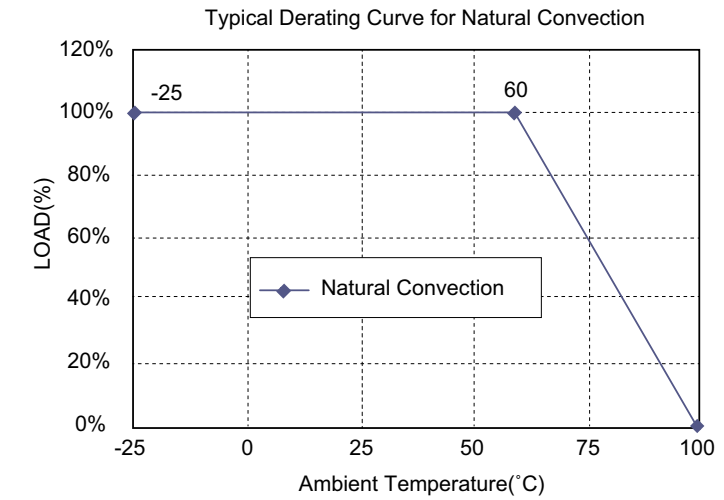

Specifications

All Specifications Typical At Nominal Line, Full Load, and 25°C Unless Otherwise Noted

INPUT SPECIFICATIONS

Input Voltage Range	24V 9-36V
	48V 18-72V
Input Surge Voltage (100ms max.)	24V 50Vdc max.
	48V 100Vdc max.
Input Filter	Pi Type
Positive Logic Remote On/Off /Control	See Note3

OUTPUT SPECIFICATIONS

Voltage Accuracy	
Single Output	±1.0% max.
Dual +Output	±1.0% max.
Dual -Output	±2.0% max.
Voltage Balance, Dual Output at Full Load	±1.0% max.
Transient Response	
Single 25% Step Load Change	< 500µs
Dual FL-1/2L±1% Error Band	< 500µs
External Trim Adj, Range	±10%
Ripple & Noise, 20MHz BW	20mV RMS, max.
75mV p-p max.	
Temperature Coefficient	±0.02%/°C max.
Short Circuit Protection	Continuous
Line Regulation (note 1)	±0.5% max.
Load Regulation (note 2)	±0.5% max.
Start up time	270ms Typ.

GENERAL SPECIFICATIONS

Efficiency	See Table
Isolation Voltage	1500 VDC min
Isolation Resistance	10 ⁸ ohms
Isolation Capacitance	1000pF Typ.
Switching Frequency	300KHz Typ.
Operating Ambient Temperature Range	-25°C to +71°C
De-rating, Above 60°C	Linearly to Zero power at +100°C
Case Temperature(note 4)	100°C max.
Storage Temperature Range	-55°C to +105°C
Humidity	95% RH max. Non condensing
MTBF MIL-STD-217F, GB, 25°C, Full Load	1500Khrs Typ.
EMI/RFI Six Sided Continuous Shield	
Dimensions	2.00 x 1.60 x 0.45 inches (50.8 x 40.6 x 11.4mm)
Case Material	Black Coated Copper with Non-Conductive Base
Weight	53 g

NOTE

1. Measured from high line to low line.
2. Measured from full load to 1/4 load.
3. Remote on/off control:
 - Logic compatibility CMOS or open collector TTL
 - EC-On >+5.5VDC to 75VDC or open circuit
 - EC-Off < 1.8VDC
 - Control common.....referenced to input minus
4. Maximum case temperature under any operating condition should not be exceeded 100°C.

EC2SC SERIES

14.4-25 WATT, 2:1 INPUT RANGE

Visit www.cincon.com for new releases and a wider selection of products

Features

- ◆ 14.4-25W Isolated Output
- ◆ 2" x 1.6" Six-Sided Shield Metal Case or Open Frame Design
- ◆ High Efficiency Up to 90%
- ◆ Fixed 300KHz Switching Frequency
- ◆ 2 : 1 Input Range
- ◆ Regulated Outputs
- ◆ Continuous Short Circuit Protection
- ◆ CE Mark Meets 2004/108/EC
- ◆ Safety Meets UL60950-1, EN60950-1 and IEC60950-1



Mechanical Dimensions

NOTE: Pin Size is 0.04±0.004 Inch (1.0±0.1mm)DIA
All Dimensions in Inches (mm)
Tolerance Inches: X.XX=±0.04, X.XXX=±0.010
Millimeters: X.X=±0.5, X.XX=±0.25

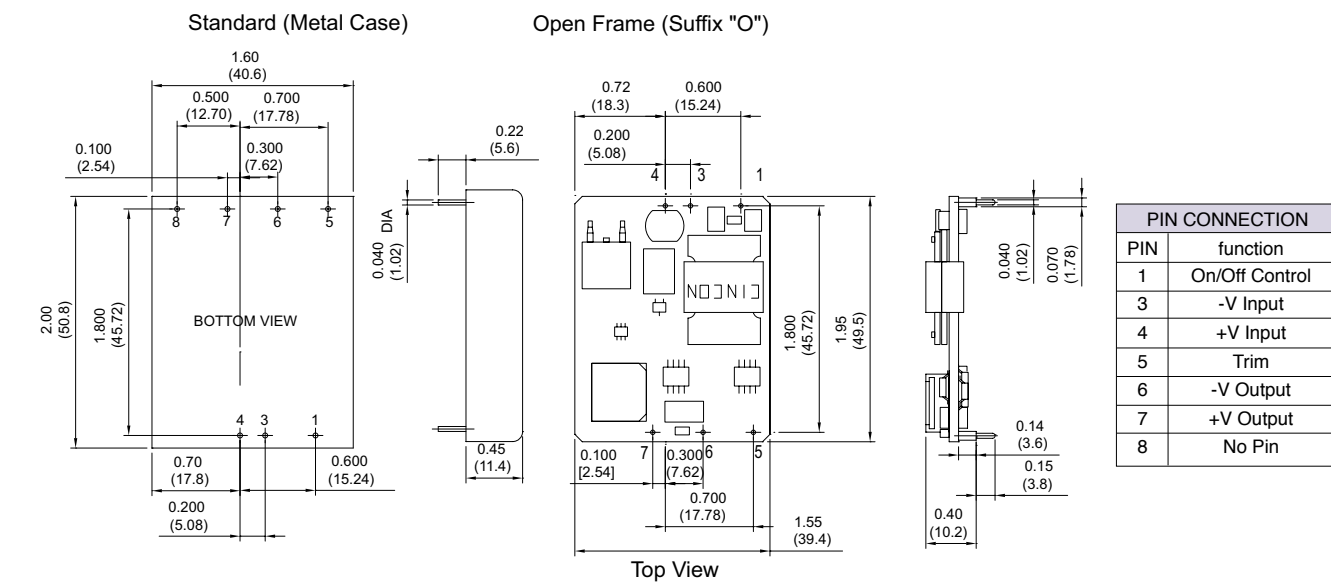

MODEL NUMBER	INPUT VOLTAGE	OUTPUT VOLTAGE	OUTPUT CURRENT		INPUT CURRENT		% EFF.	CAPACITOR LOAD MAX.
			MIN.	MAX.	NO LOAD	FULL LOAD		
EC2SC-12S18	9-18 VDC	1.8 VDC	0 mA	8000 mA	95 mA	1411 mA	85	8000µF
EC2SC-12S25	9-18 VDC	2.5 VDC	0 mA	8000 mA	95 mA	1894 mA	88	8000µF
EC2SC-12S33	9-18 VDC	3.3 VDC	0 mA	6000 mA	100 mA	1875 mA	88	6000µF
EC2SC-12S05	9-18 VDC	5 VDC	0 mA	5000 mA	105 mA	2431 mA	89	5000µF
EC2SC-12S12	9-18 VDC	12 VDC	0 mA	2000 mA	60 mA	2299 mA	87	2000µF
EC2SC-12S15	9-18 VDC	15 VDC	0 mA	1600 mA	85 mA	2325 mA	86	1600µF
EC2SC-24S18	18-36 VDC	1.8 VDC	0 mA	8000 mA	60 mA	714 mA	84	8000µF
EC2SC-24S25	18-36 VDC	2.5 VDC	0 mA	8000 mA	55 mA	947 mA	88	8000µF
EC2SC-24S33	18-36 VDC	3.3 VDC	0 mA	6000 mA	55 mA	927 mA	89	6000µF
EC2SC-24S05	18-36 VDC	5 VDC	0 mA	5000 mA	60 mA	1157 mA	90	5000µF
EC2SC-24S12	18-36 VDC	12 VDC	0 mA	2000 mA	30 mA	1149 mA	87	2000µF
EC2SC-24S15	18-36 VDC	15 VDC	0 mA	1600 mA	50 mA	1162 mA	86	1600µF
EC2SC-48S18	36-75 VDC	1.8 VDC	0 mA	8000 mA	30 mA	357 mA	84	8000µF
EC2SC-48S25	36-75 VDC	2.5 VDC	0 mA	8000 mA	30 mA	473 mA	88	8000µF
EC2SC-48S33	36-75 VDC	3.3 VDC	0 mA	6000 mA	40 mA	463 mA	89	6000µF
EC2SC-48S05	36-75 VDC	5 VDC	0 mA	5000 mA	40 mA	579 mA	90	5000µF
EC2SC-48S12	36-75 VDC	12 VDC	0 mA	2000 mA	20 mA	568 mA	88	2000µF
EC2SC-48S15	36-75 VDC	15 VDC	0 mA	1600 mA	20 mA	574 mA	87	1600µF

Derating Curve

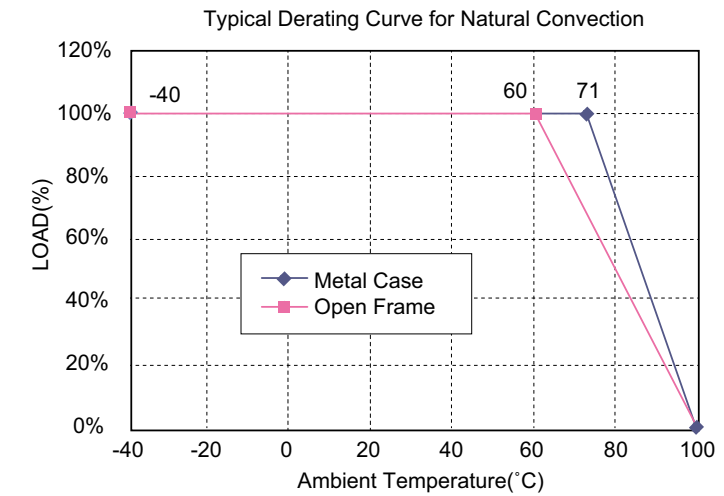

Specifications

All Specifications Typical At Nominal Line, Full Load, and 25°C Unless Otherwise Noted

INPUT SPECIFICATIONS

Input Voltage Range	12V 9-18V	24V 18-36V	48V 36-75V
Input Surge Voltage (100ms max.)	12V 25Vdc max.	24V 50Vdc max.	48V 100Vdc max.
Under Voltage Lockout	12VIn	power up 8.8V	power down 8.0V
	24VIn	power up 17V	power down 16V
	48VIn	power up 34V	power down 32V
Positive Logic Remote On/Off (note 3 & 4)	Pi Type		
Input Filter	Pi Type		

OUTPUT SPECIFICATIONS

Voltage Accuracy	±1.0% max.
Transient Response: 75% - 100% Step Load Change	
Error Band	±5% Vout nominal
Recovery Time	< 300µs
Output Voltage Adjustment Range	90% - 110%Vo
Ripple & Noise, 20MHz BW(Measured with 0.1µF MLCC)	
1.8V & 2.5V & 3.3V & 5V	20mV RMS max., 75mV pk-pk max.
12V & 15V	20mV RMS max., 100mV pk-pk max.
Temperature Coefficient	±0.02%/°C
Line Regulation (note 1)	±0.5% max.
Load Regulation (note 2)	±0.5% max.
Over Voltage Protection (Zener Diode Clamp)	
1.8V	3.3VDC typ., 2.5V ...3.3VDC typ.
3.3V	3.9VDC typ., 5V6.2VDC typ.
12V	15VDC typ., 15V18VDC typ.
Output Current Limit, % Nominal Output	110%-150%
Output Short Circuit Protection	Continuous (Hiccup Mode)
Start up time	7.5ms typ.

GENERAL SPECIFICATIONS

Efficiency	See Table
Isolation Voltage	Input/Output 1500VDC min.
Isolation Resistance	10 ⁸ ohm min.
Isolation Capacitance	1000pF typ.
Switching Frequency	300KHz typ.
Operating Ambient Temperature	-40°C to +85°C
De-rating, Above 71°C(Metal Case)	Linearly to Zero power at 100°C
De-rating, Above 60°C(Open Frame)	Linearly to Zero power at 100°C
Case Temperature (note 6)	100°C max.
Cooling	Natural Convection
Storage Temperature	-55°C to +125°C
Humidity	95% RH max. Non condensing
MTBF MIL-STD-217F, GB, 25°C, Full Load	750Khrs typ.
Thermal Shutdown Case Temperature	110°C typ.
Dimensions:	
Metal Case	2.00 x 1.60 x 0.45 inches (50.8 x 40.6 x 11.4 mm)
Open Frame	1.95 x 1.55 x 0.40 inches (49.5 x 39.4 x 10.2 mm)
Metal Case Material	Black Coated Copper with Non-Conductive Base
Weight	Metal Case: 55 g , Open Frame: 25 g

NOTE

1. Measured from high line to low line.
2. Measured from full load to 10% load.
3. Logic compatibility CMOS or open collector TTL, ref. to -Vin
Module On >3.5VDC to 75VDC or open circuit
Module Off < 1.8VDC
4. Suffix "N" to the model number with negative logic remote on/off
Module On >3.5VDC to 75VDC or open circuit
Module Off < 1.8VDC
5. Suffix "O" to the model number with open frame type.
6. Maximum case temperature under any operating condition should not be exceeded 100°C.

EC3SCW SERIES

20-30 WATT, 4:1 INPUT RANGE

Visit www.cincon.com for new releases and a wider selection of products

Features

- ◆ 20-30W Isolated Output
- ◆ 2" x 1.6" Six-Sided Shield Metal Case
- ◆ High Efficiency Up to 91%
- ◆ Fixed 300KHz Switching Frequency
- ◆ 4 : 1 Wide Input Range
- ◆ Regulated Outputs
- ◆ Continuous Short Circuit Protection
- ◆ Industry Standard Pin-Out
- ◆ CE Mark Meets 2004/108/EC
- ◆ Safety Meets UL60950-1, EN60950-1 and IEC60950-1



Mechanical Dimensions

NOTE: Pin Size is 0.04±0.004 Inch (1.0±0.1mm)DIA
All Dimensions in Inches (mm)
Tolerance Inches: X.XX=±0.04, X.XXX=±0.010
Millimeters: X.X=±0.5, X.XX=±0.25

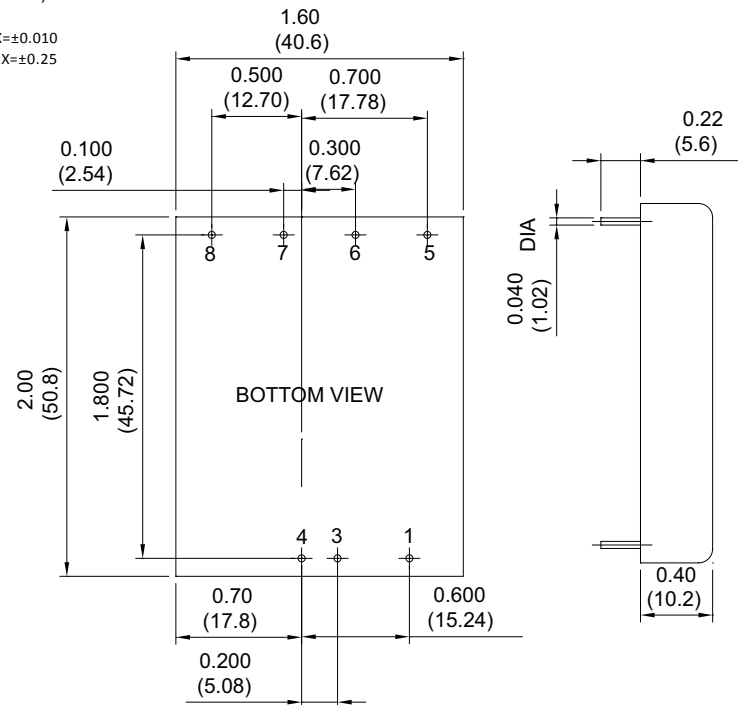

PIN CONNECTION	
PIN	function
1	On/Off Control
3	-V Input
4	+V Input
5	Trim
6	-V Output
7	+V Output
8	No Pin

MODEL NUMBER	INPUT VOLTAGE	OUTPUT VOLTAGE	OUTPUT CURRENT		INPUT CURRENT		% EFF.	CAPACITOR LOAD MAX.
			MIN.	MAX.	NO LOAD	FULL LOAD		
EC3SCW-24S3V3	9-36 VDC	3.3 VDC	0 mA	7500 mA	50 mA	1172 mA	88	7500µF
EC3SCW-24S05	9-36 VDC	5 VDC	0 mA	6000 mA	60 mA	1404 mA	89	6000µF
EC3SCW-24S12	9-36 VDC	12 VDC	0 mA	2500 mA	80 mA	1374 mA	91	2500µF
EC3SCW-24S15	9-36 VDC	15 VDC	0 mA	2000 mA	50 mA	1374 mA	91	2000µF
EC3SCW-48S3V3	18-75 VDC	3.3 VDC	0 mA	7500 mA	30 mA	586 mA	88	7500µF
EC3SCW-48S05	18-75 VDC	5 VDC	0 mA	6000 mA	30 mA	694 mA	90	6000µF
EC3SCW-48S12	18-75 VDC	12 VDC	0 mA	2500 mA	40 mA	687 mA	91	2500µF
EC3SCW-48S15	18-75 VDC	15 VDC	0 mA	2000 mA	50 mA	687 mA	91	2000µF

Derating Curve

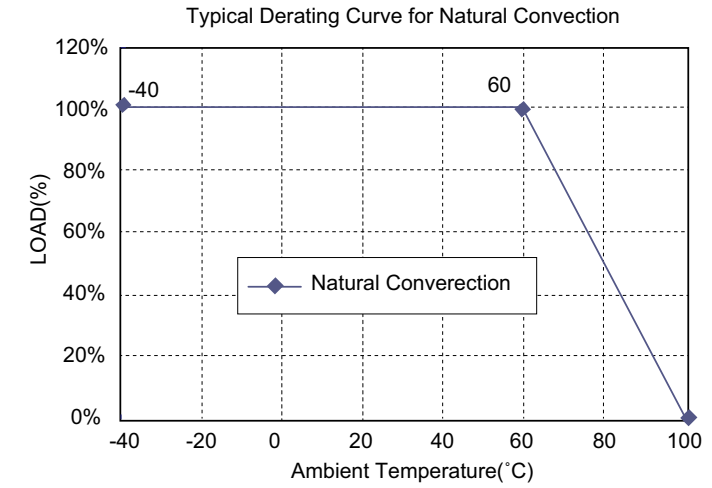

Specifications

All Specifications Typical At Nominal Line, Full Load, and 25°C Unless Otherwise Noted

INPUT SPECIFICATIONS

Input Voltage Range	24V 9-36V
	48V 18-75V
Input Surge Voltage (100ms max.)	24V 50Vdc max.
	48V 100Vdc max.
Under Voltage Lockout	24Vin
	power up 8.8V typ.
	power down 8.0V typ.
	48Vin
	power up 17V typ.
	power down 16V typ.
Positive Logic Remote On/Off (note 3 & 4)	
Input Filter	Pi Type

OUTPUT SPECIFICATIONS

Voltage Accuracy:	±1.5% max.
Transient Response: 75% - 100% Step Load Change	
Error Band	±5% Vout nominal
Recovery Time	< 300µs
External Adjustment Range, %Vo	±10%
Ripple & Noise, 20MHz BW (Measured with 0.1µF MLCC)	
3.3V & 5V	20mV RMS max.
	75mV pk-pk max.
12V & 15V	20mV RMS max.
	100mV pk-pk max.
Temperature Coefficient	±0.02%/°C
Line Regulation (note 1)	±0.5% max.
Load Regulation (note 2)	±0.5% max.
Output Over voltage Protection (Zener or TVS Clamp)	
3.3V	3.9V
5V	6.2V
12V	15V
15V	18V
Output Current Limit, % Nominal Output	110%-150%
Output Short Circuit Protection	Continuous (Hiccup Mode)
Start up time	8ms typ.

GENERAL SPECIFICATIONS

Efficiency	See Table
Isolation Voltage	Input/Output1500VDC min.
Isolation Resistance	10 ⁸ ohm min.
Isolation Capacitance	1000pF typ.
Switching Frequency	24Vin 300KHz typ.
	48Vin 250KHz typ.
Operating Ambient Temperature	-40°C to +85°C
De-rating, Above 60°C	Linearly to Zero power at 100°C
Case Temperature (note 5)	100°C max.
Cooling	Natural Convection
Storage Temperature	-55°C to +125°C
Humidity	95% RH max. Non condensing
MTBF MIL-STD-217F, GB, 25°C, Full Load	650Khrs typ.
Thermal Shutdown Case Temp.	110°C typ.
Dimensions	2.00 x 1.60 x 0.40 inches (50.8 x 40.6 x 10.2 mm)
Case Material	Black Coated Copper with Non-Conductive Base
Weight	50 g

NOTE

1. Measured from high line to low line.
2. Measured from full load to 10% load.
3. Logic compatibility CMOS or open collector TTL, ref. to -Vin
Module On >3.5VDC to 75VDC or open circuit
Module Off < 1.2VDC
4. Suffix "N" to the model number with negative logic remote on/off
Module On < 1.2VDC
Module Off >3.5VDC to 75VDC or open circuit
5. Maximum case temperature under any operating condition should not be exceeded 100°C.

EC3C SERIES

15 WATT, 2:1 INPUT RANGE

Visit www.cincon.com for new releases and a wider selection of products

Features

- ◆ 15W Isolated Output
- ◆ Efficiency to 82%
- ◆ 2" x 2" Six-Sided Shield Metal Case
- ◆ Alternative Pin Configuration
- ◆ Fixed 200KHz Switching Frequency

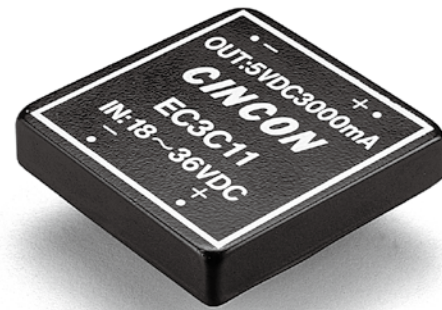

Not Recommended For New Design

Mechanical Dimensions

All Dimensions in Inches (mm)
 Tolerance Inches: X.XX=±0.04, X.XXX=±0.010
 Millimeters: X.X=±0.5, X.XX=±0.25

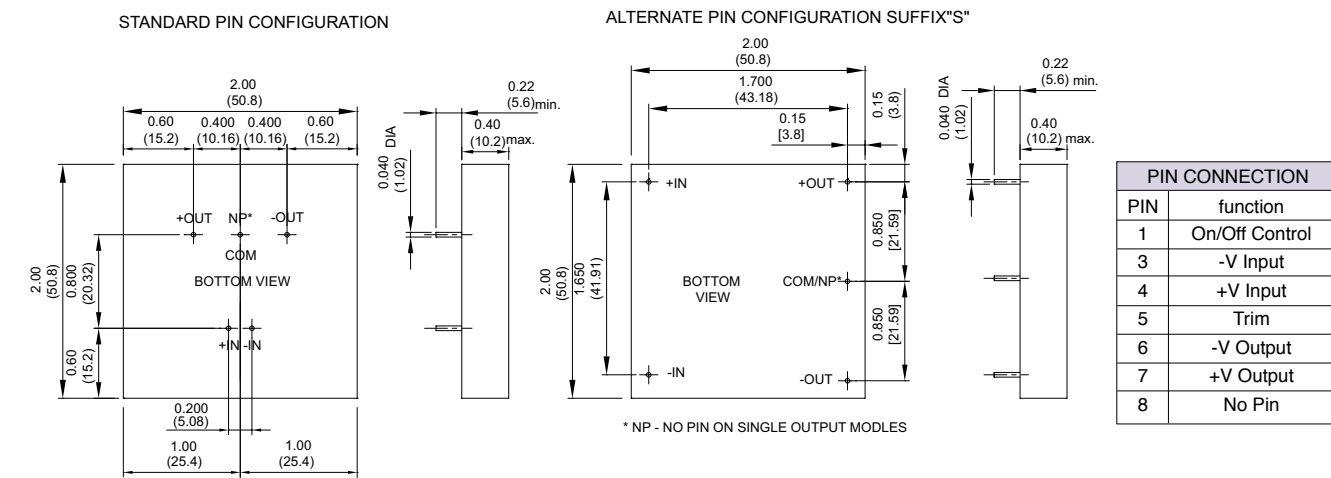

MODEL NUMBER	INPUT VOLTAGE	OUTPUT VOLTAGE	OUTPUT CURRENT	INPUT CURRENT		% EFF.
				NO LOAD	FULL LOAD	
EC3C01	9-18 VDC	5 VDC	3000 mA	30 mA	1660 mA	75
EC3C02	9-18 VDC	12 VDC	1250 mA	30 mA	1625 mA	78
EC3C03	9-18 VDC	15 VDC	1000 mA	30 mA	1625 mA	78
EC3C04	9-18 VDC	±12 VDC	±625 mA	35 mA	1620 mA	77
EC3C05	9-18 VDC	±15 VDC	±500 mA	35 mA	1620 mA	77
EC3C06	9-18 VDC	±5 VDC	±1500 mA	35 mA	1620 mA	77
EC3C07	9-18 VDC	3.3 VDC	3000 mA	30 mA	1178 mA	70
EC3C11	18-36 VDC	5 VDC	3000 mA	15 mA	812 mA	78
EC3C12	18-36 VDC	12 VDC	1250 mA	20 mA	772 mA	81
EC3C13	18-36 VDC	15 VDC	1000 mA	20 mA	772 mA	81
EC3C14	18-36 VDC	±12 VDC	±625 mA	25 mA	780 mA	80
EC3C15	18-36 VDC	±15 VDC	±500 mA	25 mA	780 mA	80
EC3C16	18-36 VDC	±5 VDC	±1500 mA	25 mA	780 mA	80
EC3C17	18-36 VDC	3.3 VDC	3000 mA	15 mA	557 mA	74
EC3C21	36-72 VDC	5 VDC	3000 mA	10 mA	390 mA	80
EC3C22	36-72 VDC	12 VDC	1250 mA	15 mA	381 mA	82
EC3C23	36-72 VDC	15 VDC	1000 mA	15 mA	381 mA	82
EC3C24	36-72 VDC	±12 VDC	±625 mA	20 mA	386 mA	81
EC3C25	36-72 VDC	±15 VDC	±500 mA	20 mA	386 mA	81
EC3C26	36-72 VDC	±5 VDC	±1500 mA	20 mA	386 mA	81
EC3C27	36-72 VDC	3.3 VDC	3000 mA	20 mA	271 mA	76

Derating Curve

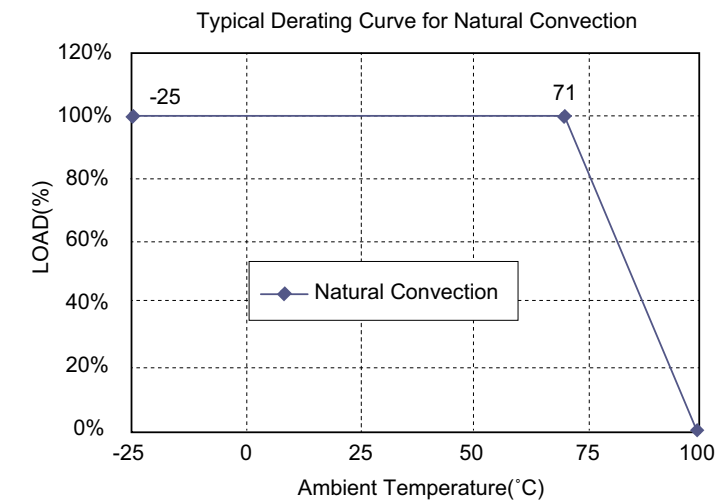

Specifications

All Specifications Typical At Nominal Line, Full Load, and 25°C Unless Otherwise Noted

INPUT SPECIFICATIONS

Input Voltage Range	12V 9-18V
	24V 18-36V
	48V 36-72V
Input Filter	Pi Type

OUTPUT SPECIFICATIONS

Voltage Accuracy	
Single Output	±1.0% max.
Dual +Output	±1.0% max.
Dual - Output	±3.0% max.
Voltage Balance Dual Output Full Load	±1.0% max.
Transient Response	
Single 25% Step Load Change	< 500µs
Dual FL-1/2L±1% Error Band	< 500µs
Ripple and Noise, 20MHz BW	10mV RMS. max.
	75mV p-p max.

Temperature Coefficient	±0.02%/°C
Short Circuit Protection	ndefinite & Current Limit
Line Regulation (note 1), Single/Dual Output	±0.2% max.
Load Regulation (note 2), Single/Dual Output	±1.0% max.

GENERSPECIFICATIONS

Efficiency	See Table
Isolation Voltage	500 VDC min.
Isolation Resistance	10 ⁹ ohms
Switching Frequency	200KHz, typ.
Operating Ambient Temperature Range	-25°C to +71°C
De-rating, Above 71°C	Linearly to Zero power at 100°C
Case Temperature (note 5)	100°C max.
Cooling	Natural Convection
Storage Temperature Range	-40°C to +100°C
EMI/RFI	Six-Sided Continuous Shield
Dimensions	2.00 x 2.00 x 0.40 inches (50.8 x 50.8 x 10.2mm)
Case Material	Black Coated Copper With Non-Conductive Base
Weight	57 g

NOTE

1. Measured from high line to low line.
2. Measured from full load to 1/4 full load.
3. Determine the correct fuse size by calculating the maximum DC current drain at low line input, maximum load and then adding 20 to 25% to get desired fuse size.
4. Alternative pin configuration suffix "S"
5. Maximum case temperature under any operating condition should not be exceeded 100°C.

EC3CB SERIES

15 WATT, 2:1 INPUT RANGE

Visit www.cincon.com for new releases and a wider selection of products

Features

- ◆ 15W Isolated Output
- ◆ Efficiency to 82%
- ◆ 2" x 2" Six-Sided Shield Metal Case
- ◆ Fixed 200KHz Switching Frequency
- ◆ Regulated Outputs
- ◆ Pi Input Filter
- ◆ Continuous Short Circuit Protection
- ◆ Meets EN55022 Class B, Conducted
- ◆ Alternative Pin Configuration

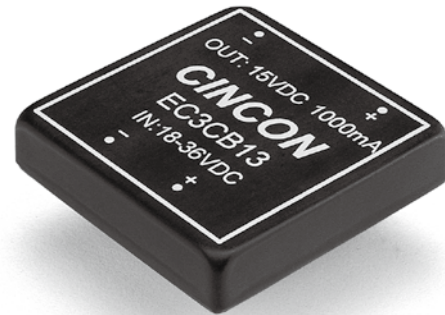

Mechanical Dimensions

All Dimensions in Inches (mm)
Tolerance Inches: X.XX=±0.04, X.XXX=±0.010
Millimeters: X.X=±0.5, X.XX=±0.25

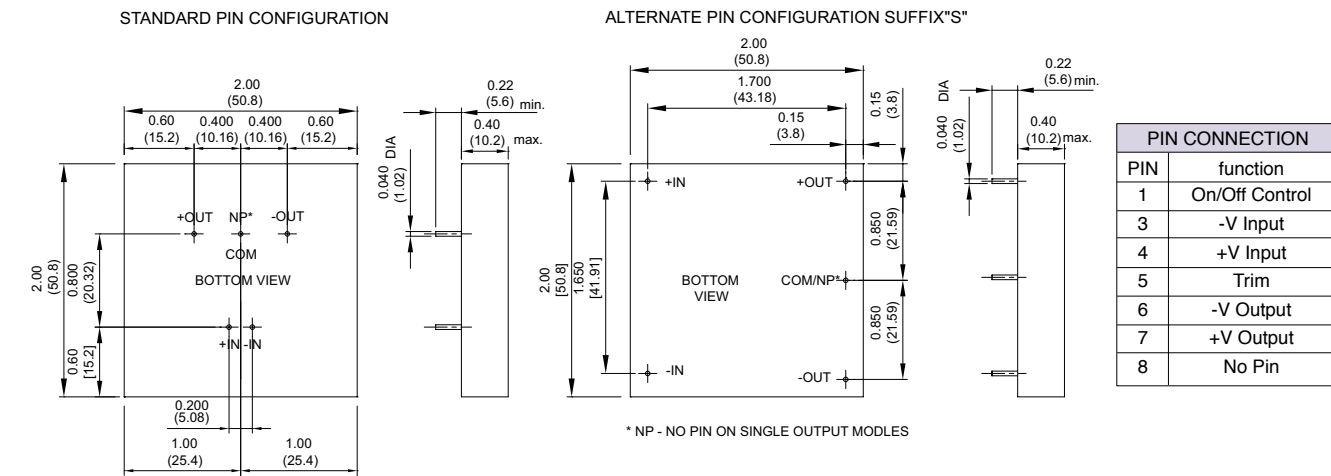

MODEL NUMBER	INPUT VOLTAGE	OUTPUT VOLTAGE	OUTPUT CURRENT	INPUT CURRENT		% EFF.
				NO LOAD	FULL LOAD	
EC3CB01	9-18 VDC	5 VDC	3000 mA	30 mA	1660 mA	75
EC3CB02	9-18 VDC	12 VDC	1250 mA	30 mA	1625 mA	78
EC3CB03	9-18 VDC	15 VDC	1000 mA	30 mA	1625 mA	78
EC3CB04	9-18 VDC	±12 VDC	±625 mA	35 mA	1620 mA	77
EC3CB05	9-18 VDC	±15 VDC	±500 mA	35 mA	1620 mA	77
EC3CB06	9-18 VDC	±5 VDC	±1500 mA	35 mA	1620 mA	77
EC3CB07	9-18 VDC	3.3 VDC	3000 mA	30 mA	1178 mA	70
EC3CB11	18-36 VDC	5 VDC	3000 mA	15 mA	812 mA	78
EC3CB12	18-36 VDC	12 VDC	1250 mA	20 mA	772 mA	81
EC3CB13	18-36 VDC	15 VDC	1000 mA	20 mA	772 mA	81
EC3CB14	18-36 VDC	±12 VDC	±625 mA	25 mA	780 mA	80
EC3CB15	18-36 VDC	±15 VDC	±500 mA	25 mA	780 mA	80
EC3CB16	18-36 VDC	±5 VDC	±1500 mA	25 mA	780 mA	80
EC3CB17	18-36 VDC	3.3 VDC	3000 mA	15 mA	557 mA	74
EC3CB21	36-72 VDC	5 VDC	3000 mA	10 mA	390 mA	80
EC3CB22	36-72 VDC	12 VDC	1250 mA	15 mA	381 mA	82
EC3CB23	36-72 VDC	15 VDC	1000 mA	15 mA	381 mA	82
EC3CB24	36-72 VDC	±12 VDC	±625 mA	20 mA	386 mA	81
EC3CB25	36-72 VDC	±15 VDC	±500 mA	20 mA	386 mA	81
EC3CB26	36-72 VDC	±5 VDC	±1500 mA	20 mA	386 mA	81
EC3CB27	36-72 VDC	3.3 VDC	3000 mA	20 mA	271 mA	76

Derating Curve

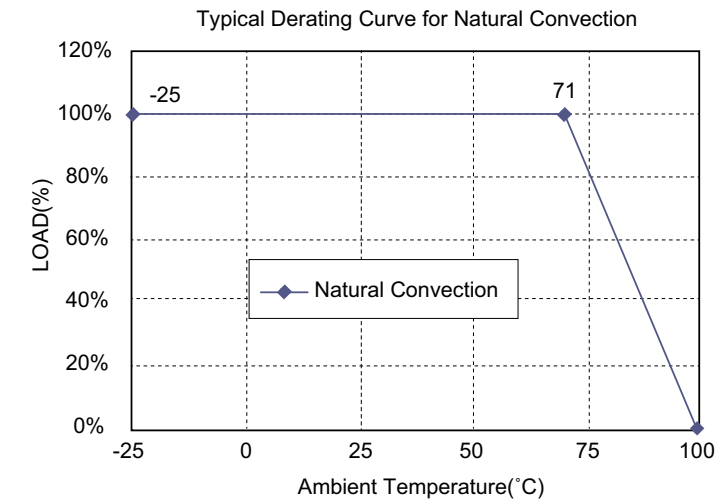

Specifications

All Specifications Typical At Nominal Line, Full Load, and 25°C Unless Otherwise Noted

INPUT SPECIFICATIONS

Input Voltage Range	12V 9-18V
	24V 18-36V
	48V 36-72V
Input Filter	Pi Type

OUTPUT SPECIFICATIONS

Voltage Accuracy	
Single Output	±1.0% max.
Dual +Output	±1.0% max.
Dual - Output	±3.0% max.
Voltage Balance Dual Output Full Load	±1.0% max.
Transient Response	
Single 25% Step Load Change	< 500µs
Dual FL-1/2L±1% Error Band	< 500µs
Ripple and Noise, 20MHz BW	
	10mV RMS. max.
	75mV p-p max.
Temperature Coefficient	±0.02%/°C
Short Circuit Protection	Indefinite & Current Limit
Line Regulation Single/Dual Output (note 1)	±0.2% max.
Load Regulation Single/Dual Output (note 2)	±1.0% max.

GENERAL SPECIFICATIONS

Efficiency	See Table
Isolation Voltage	500 VDC min.
Isolation Resistance	10 ⁹ ohms
Switching Frequency	200KHz typ.
Operating Ambient Temperature Range	-25°C to +71°C
De-rating, Above 71°C	Linearly to Zero power at 100°C
Case Temperature (note 5)	100°C max.
Cooling	Natural Convection
Storage Temperature Range	-40°C to +100°C
EMI/RFI	Conductive EMI Meet EN55022 Class B
Dimensions	2.00 x 2.00 x 0.40 inches (50.8 x 50.8 x 10.2mm)
Case Material	Black Coated Copper With Non-Conductive Base
Weight	57 g

NOTE

1. Measured from high line to low line.
2. Measured from full load to 1/4 full load.
3. Determine the correct fuse size by calculating the maximum DC current drain at low line input, maximum load and then adding 20 to 25% to get desired fuse size.
4. Alternative pin configuration suffix "S"
5. Maximum case temperature under any operating condition should not be exceeded 100°C.

EC5C SERIES

15 WATT, 4:1 INPUT RANGE

Visit www.cincon.com for new releases and a wider selection of products

Features

- ◆ 15W Isolated Output
- ◆ 2" x 2" Six-Sided Shield Metal Case
- ◆ 4 : 1 Input Range
- ◆ Efficiency to 84%
- ◆ Remote On/Off Control
- ◆ Regulated Outputs
- ◆ Continuous Short Circuit Protection
- ◆ CE Mark Meets 2004/108/EC
- ◆ UL60950-1 Approval

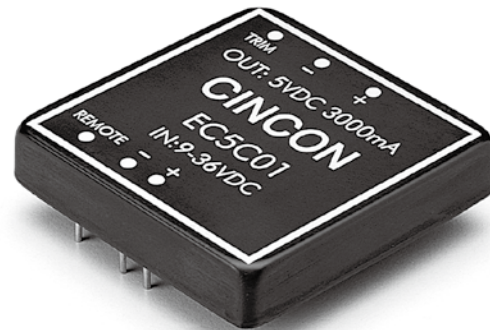

Mechanical Dimensions

All Dimensions in Inches (mm)
 Tolerance Inches: X.XX=±0.04, X.XXX=±0.010
 Millimeters: X.X=±0.5, X.XX=±0.25

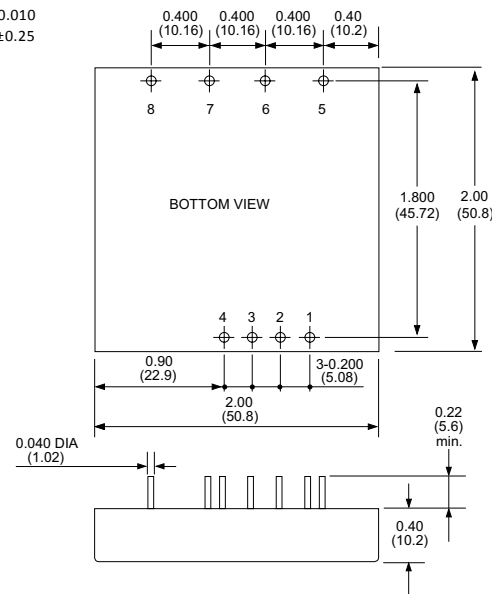

PIN CONNECTION			
PIN	Single	Dual	Triple
1	Remote On/Off Control		
2	No Pin	No Pin	No Pin
3	-V Input	-V Input	-V Input
4	+V Input	+V Input	+V Input
5	Trim	Trim	-Aux. Output
6	-V Output	-V Output	Common
7	+V Output	Common	+5V Output
8	No Pin	+V Output	+Aux. Output

MODEL NUMBER	INPUT VOLTAGE	OUTPUT VOLTAGE	OUTPUT CURRENT		INPUT CURRENT		% EFF.
			MIN.	MAX.	NO LOAD	FULL LOAD	
EC5C01	9-36 VDC	5 VDC	0 mA	3000 mA	15 mA	770 mA	81
EC5C02	9-36 VDC	12 VDC	0 mA	1250 mA	15 mA	745 mA	84
EC5C03	9-36 VDC	15 VDC	0 mA	1000 mA	15 mA	760 mA	82
EC5C04	9-36 VDC	±5 VDC	±0 mA	±1500 mA	20 mA	770 mA	81
EC5C05	9-36 VDC	±12 VDC	±0 mA	±625 mA	20 mA	760 mA	82
EC5C06	9-36 VDC	±15 VDC	±0 mA	±500 mA	20 mA	750 mA	83
EC5C07	9-36 VDC	5/±12 VDC	250/±100 mA	1500/±310 mA	20 mA	780 mA	80
EC5C08	9-36 VDC	5/±15 VDC	250/±100 mA	1500/±250 mA	20 mA	780 mA	80
EC5C09	9-36 VDC	3.3 VDC	0 mA	3000 mA	15 mA	530 mA	78
EC5C11	18-72 VDC	5 VDC	0 mA	3000 mA	10 mA	385 mA	81
EC5C12	18-72 VDC	12 VDC	0 mA	1250 mA	10 mA	375 mA	83
EC5C13	18-72 VDC	15 VDC	0 mA	1000 mA	10 mA	380 mA	82
EC5C14	18-72 VDC	±5 VDC	±0 mA	±1500 mA	15 mA	385 mA	81
EC5C15	18-72 VDC	±12 VDC	±0 mA	±625 mA	15 mA	375 mA	83
EC5C16	18-72 VDC	±15 VDC	±0 mA	±500 mA	15 mA	385 mA	81
EC5C17	18-72 VDC	5/±12 VDC	250/±100 mA	1500/±310 mA	15 mA	385 mA	81
EC5C18	18-72 VDC	5/±15 VDC	250/±100 mA	1500/±250 mA	15 mA	390 mA	80
EC5C19	18-72 VDC	3.3 VDC	0 mA	3000 mA	10 mA	270 mA	77

Derating Curve

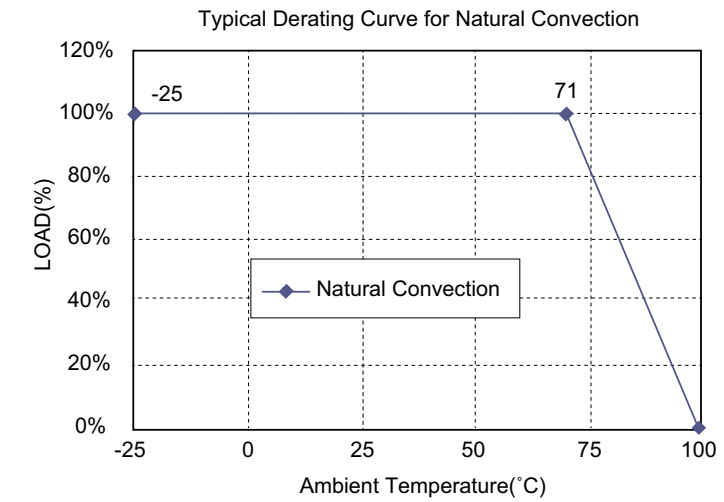

Specifications

All Specifications Typical At Nominal Line, Full Load, and 25°C Unless Otherwise Noted

INPUT SPECIFICATIONS

Input Voltage Range	24V.....9-36V 48V.....18-72V
Input Surge Voltage (100ms max.)	24V.....50Vdc max. 48V.....100Vdc max.
Input Filter	Pi Type

OUTPUT SPECIFICATIONS

Voltage Accuracy	Single Output, Dual +Output Dual-Output Triple, 5V 12V/15V	±1.0% max. ±3.0% max. ±2.0% max. ±3.0% max.
Voltage Balance (Dual)		±1.0% max.
Transient Response	Single 25% Step Load Change Dual FL-1/2L±1% Error Band	< 500µs < 500µs
External Trim Adj. Range		±10%
Ripple & Noise, 20MHz BW		10mV RMS max., 75mV pk-pk max.
Temperature Coefficient		±0.02%/°C
Short Circuit Protection		Continuous
Line Regulation Single/Dual (note 1)	Triple	±0.2% max. ±1.0% max.
Load Regulation Single/Dual (note 2)	Triple	±1.0% max. ±5.0% max.
Start up time		300ms typ.

GENERAL SPECIFICATIONS

Efficiency	See Table
Isolation Voltage	500 VDC min.
Isolation Resistance	10 ⁹ ohm min.
Isolation Capacitance	1000pF typ.
Switching Frequency	300KHz typ.
Case Grounding	Connected to Output Common
Operating Ambient Temperature Range	-25°C to +71°C
De-rating, Above 71°C	Linearly to Zero power at 100°C
Case Temperature (note 3)	100°C max.
Cooling	Natural Convection
Storage Temperature Range	-55°C to +105°C
Humidity	95% RH max. Non condensing
MTBF MIL-STD-217F, GB, 25°C, Full Load	1300Khrs typ.
EMI/RFI	Six-Sided Continuous Shield
Dimensions	2.00 x 2.00 x 0.40 inches (50.8 x 50.8 x 10.2mm)
Case Material	Black Coated Copper With Non-Conductive Base
Weight	59 g

NOTE

1. Measured from high line to low line.
2. Measured from full load to 1/4 full load.
3. Maximum case temperature under any operating condition should not be exceeded 100°C.

EC6C SERIES

25-30 WATT, 2:1 INPUT RANGE

Visit www.cincon.com for new releases and a wider selection of products

Features

- ◆ 25-30W Isolated Output
- ◆ 2" x 2" Six-Sided Shield Metal Case
- ◆ 2 : 1 Input Range
- ◆ Regulated Outputs
- ◆ Efficiency to 88%
- ◆ Remote ON/OFF Control
- ◆ CE Mark Meets 2004/108/EC
- ◆ UL60950-1 Approval

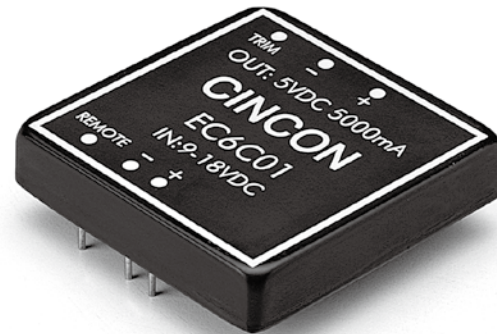

Mechanical Dimensions

All Dimensions in Inches (mm)
 Tolerance Inches: X.XX±0.04, X.XXX±0.010
 Millimeters: X.X±0.5, X.XX±0.25

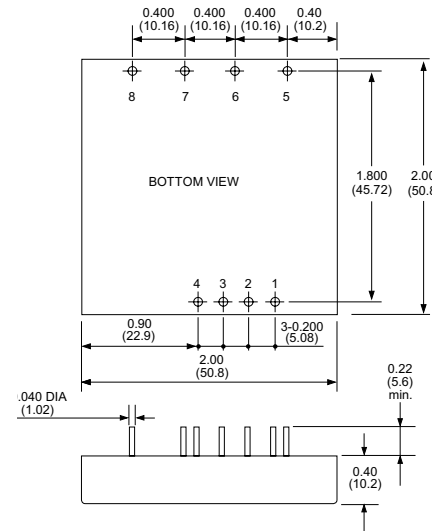

PIN CONNECTION			
PIN	Single Output	Dual Output	Triple
1	Remote On/Off Control		
2	No Pin	No Pin	No Pin
3	-V Input	-V Input	-V Input
4	+V Input	+V Input	+V Input
5	Trim	Trim	-Aux. Output
6	-V Output	-V Output	Common
7	+V Output	+V Output	+5V Output
8	No Pin	+V Output	+Aux. Output

MODEL NUMBER	INPUT VOLTAGE	OUTPUT VOLTAGE	OUTPUT CURRENT		INPUT CURRENT		% EFF.
			MIN.	MAX.	NO LOAD	FULL LOAD	
EC6C01	9-18 VDC	5 VDC	0 mA	5000 mA	30 mA	2675 mA	84
EC6C02	9-18 VDC	12 VDC	0 mA	2500 mA	30 mA	3050 mA	88
EC6C03	9-18 VDC	15 VDC	0 mA	2000 mA	30 mA	3050 mA	88
EC6C04	9-18 VDC	±5 VDC	±0 mA	±2500 mA	35 mA	2675 mA	83
EC6C05	9-18 VDC	±12 VDC	±0 mA	±1250 mA	35 mA	3050 mA	88
EC6C06	9-18 VDC	±15 VDC	±0 mA	±1000 mA	35 mA	3050 mA	87
EC6C07	9-18 VDC	5/±12 VDC	500/±100 mA	3500/±310 mA	35 mA	2640 mA	81
EC6C08	9-18 VDC	5/±15 VDC	500/±100 mA	3500/±250 mA	35 mA	2640 mA	82
EC6C09	9-18 VDC	3.3 VDC	0 mA	5000 mA	30 mA	1860 mA	80
EC6C11	18-36 VDC	5 VDC	0 mA	5000 mA	30 mA	1336 mA	83
EC6C12	18-36 VDC	12 VDC	0 mA	2500 mA	30 mA	1525 mA	87
EC6C13	18-36 VDC	15 VDC	0 mA	2000 mA	30 mA	1525 mA	87
EC6C14	18-36 VDC	±5 VDC	±0 mA	±2500 mA	30 mA	1336 mA	82
EC6C15	18-36 VDC	±12 VDC	±0 mA	±1250 mA	30 mA	1470 mA	87
EC6C16	18-36 VDC	±15 VDC	±0 mA	±1000 mA	30 mA	1470 mA	86
EC6C17	18-36 VDC	5/±12 VDC	500/±100 mA	3500/±310 mA	30 mA	1320 mA	82
EC6C18	18-36 VDC	5/±15 VDC	500/±100 mA	3500/±250 mA	30 mA	1320 mA	82
EC6C19	18-36 VDC	3.3 VDC	0 mA	5000 mA	30 mA	920 mA	79
EC6C21	36-72 VDC	5 VDC	0 mA	5000 mA	20 mA	660 mA	83
EC6C22	36-72 VDC	12 VDC	0 mA	2500 mA	20 mA	765 mA	87
EC6C23	36-72 VDC	15 VDC	0 mA	2000 mA	20 mA	765 mA	87
EC6C24	36-72 VDC	±5 VDC	±0 mA	±2500 mA	25 mA	660 mA	82
EC6C25	36-72 VDC	±12 VDC	±0 mA	±1250 mA	25 mA	735 mA	87
EC6C26	36-72 VDC	±15 VDC	±0 mA	±1000 mA	25 mA	735 mA	87
EC6C27	36-72 VDC	5/±12 VDC	500/±100 mA	3500/±310 mA	25 mA	655 mA	83
EC6C28	36-72 VDC	5/±15 VDC	500/±100 mA	3500/±250 mA	25 mA	655 mA	82
EC6C29	36-72 VDC	3.3 VDC	0 mA	5000 mA	20 mA	460 mA	79

Derating Curve

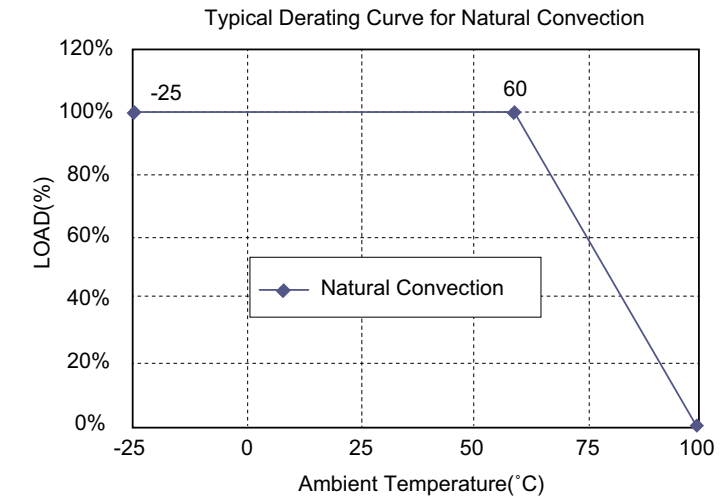

Specifications

All Specifications Typical At Nominal Line, Full Load, and 25°C Unless Otherwise Noted

INPUT SPECIFICATIONS

Input Voltage Range	12V 9-18V
	24V 18-36V
	48V 36-72V
Input Surge Voltage (100ms max.)	12V 25Vdc max.
	24V 50Vdc max.
	48V 100Vdc max.
Input Filter	Pi Type

OUTPUT SPECIFICATIONS

Voltage Accuracy	
Single Output	±2.0% max.
Dual +Output	±2.0% max.
Dual - Output	±3.0% max.
Triple, 5V	±2.0% max.
12V/15V	±5.0% max.
Voltage Balance (Dual)	±1.0% max.
Transient Response.	
Single 25% Step Load Change	< 500µs
Dual FL-1/2L±1% Error Band	< 500µs
External Trim Adj. Range	±10%
Ripple and Noise, 20MHz BW	10mV RMS. max.
	75mV p-p max.
Temperature Coefficient	±0.02%/°C
Short Circuit Protection	Continuous
Line Regulation Single/Dual (note 1)	±0.5% max.
Triple	±1.0% max.
Load Regulation Single/Dual (note 2)	±1.0% max.
Triple	±5.0% max.
Start up time	900ms typ.

GENERAL SPECIFICATIONS

Efficiency	See Table
Isolation Voltage	500 VDC min.
Isolation Resistance	10 ⁹ ohms
Isolation Capacitance	500pF typ.
Switching Frequency	300KHz typ.
Case Grounding	Connected to Output Common
Operating Ambient Temperature Range	-25°C to +71°C
De-rating, Above 60°C	Linearly to Zero power at 100°C
Case Temperature (note 3)	100°C max.
Cooling	Natural Convection
Storage Temperature Range	-55°C to +105°C
Humidity	95% RH max. Non condensing
MTBF MIL-STD-217F, GB, 25°C, Full Load	900Khrs typ.
EMI/RFI	Six-Sided Continuous Shield
Dimensions	2.00 x 2.00 x 0.40 inches (50.8 x 50.8 x 10.2mm)
Case Material	Black Coated Copper With Non-Conductive Base
Weight	65 g

NOTE

1. Measured from high line to low line.
2. Measured from full load to 1/4 full load.
3. Maximum case temperature under any operating condition should not be exceeded 100°C.

EC7C SERIES

40 WATT, 2:1 INPUT RANGE

Visit www.cincon.com for new releases and a wider selection of products

Features

- ◆ 40W Isolated Output
- ◆ 2" x 2" Six-Sided Shield Metal Case
- ◆ High Efficiency Up to 93%
- ◆ Fixed 350KHz Switching Frequency
- ◆ 2 : 1 Input Range
- ◆ Regulated Outputs
- ◆ Continuous Short Circuit Protection
- ◆ CE Mark Meets 2004/108/EC
- ◆ UL60950-1 Approval



Mechanical Dimensions

NOTE: Pin Size is 0.02±0.002 Inch(0.5±0.05mm)DIA
All Dimensions in Inches (mm)
Tolerance Inches: X.XX±0.04, X.XXX±0.010
Millimeters: X.X±0.5, X.XX±0.25

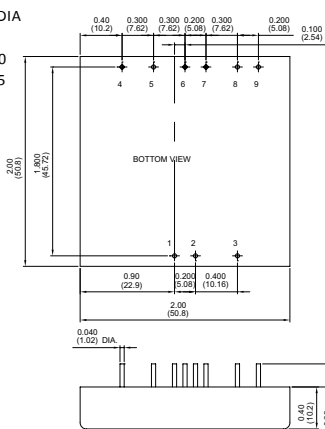

PIN CONNECTION				
PIN	Single	Dual	Dual Positive	Triple
1	+V Input	+V Input	+V Input	+V Input
2	-V Input	-V Input	-V Input	-V Input
3	On / Off	On / Off	On / Off	On / Off
4	NC	No Pin	+3.3Vout	+Aux. Out
5	- Sense	+V Output	Com(3.3V RTM)	Common
6	+Sense	Common	Trim	- Aux. Out
7	+V Output	Common	NC	+V Output
8	-V Output	-V Output	+5V Output	-V Output(Common)
9	Trim	Trim	Com(5V RTN)	NC

*NC : NO CONNECTION WITH PIN

MODEL NUMBER	INPUT VOLTAGE	OUTPUT VOLTAGE	OUTPUT CURRENT		INPUT CURRENT		% EFF.	CAPACITOR LOAD MAX.
			MIN.	MAX.	NO LOAD	FULL LOAD		
EC7C-12S25	9-18 VDC	2.5 VDC	0 mA	10000 mA	200 mA	2354 mA	88.5	10000µF
EC7C-12S33	9-18 VDC	3.3 VDC	0 mA	10000 mA	200 mA	3090 mA	89	10000µF
EC7C-12S05	9-18 VDC	5 VDC	0 mA	8000 mA	200 mA	3683 mA	90.5	8000µF
EC7C-12S12	9-18 VDC	12 VDC	0 mA	3333 mA	200 mA	3643 mA	91.5	3300µF
EC7C-12S15	9-18 VDC	15 VDC	0 mA	2666 mA	200 mA	3642 mA	91.5	2700µF
EC7C-12D12	9-18 VDC	±12 VDC	90 mA	±1800 mA	100 mA	4022 mA	89.5	1800µF
EC7C-12D15	9-18 VDC	±15 VDC	70 mA	±1400 mA	100 mA	3867 mA	90.5	1400µF
EC7C-12D3305	9-18 VDC	3.3/5.0 VDC	0 mA	10A/7.5 A	100 mA	3727 mA	89	7270µF/7270µF
EC7C-12T3312	9-18 VDC	3.3/±12 VDC	0.6A/±40 mA	6A/±0.4 A	200 mA	2768 mA	88.5	6000µF/400µF
EC7C-12T3315	9-18 VDC	3.3/±15 VDC	0.6A/±30 mA	6A/±0.3 A	200 mA	2712 mA	88.5	6000µF/330µF
EC7C-12T0512	9-18 VDC	5.0/±12 VDC	0.6A/±40 mA	6A/±0.4 A	200 mA	3729 mA	88.5	6000µF/400µF
EC7C-12T0515	9-18 VDC	5.0/±15 VDC	0.6A/±30 mA	6A/±0.3 A	200 mA	3611 mA	90	6000µF/330µF
EC7C-24S25	18-36 VDC	2.5 VDC	0 mA	10000 mA	100 mA	1157 mA	90	10000µF
EC7C-24S33	18-36 VDC	3.3 VDC	0 mA	10000 mA	100 mA	1519 mA	90.5	10000µF
EC7C-24S05	18-36 VDC	5 VDC	0 mA	8000 mA	110 mA	1812 mA	92	8000µF
EC7C-24S12	18-36 VDC	12 VDC	0 mA	3333 mA	100 mA	1792 mA	93	3300µF
EC7C-24S15	18-36 VDC	15 VDC	0 mA	2666 mA	100mA	1792 mA	93	2700µF
EC7C-24D12	18-36 VDC	±12 VDC	90 mA	±1800 mA	100 mA	1967 mA	91.5	1800µF
EC7C-24D15	18-36 VDC	±15 VDC	70 mA	±1400 mA	100 mA	1902 mA	92	1400µF
EC7C-24D3305	18-36 VDC	3.3/5.0 VDC	0 mA	10A/7.5 A	50 mA	1843 mA	90	7270µF/7270µF
EC7C-24T3312	18-36 VDC	3.3/±12 VDC	0.6A/±40 mA	6A/±0.4 A	100 mA	1361 mA	90	6000µF/400µF
EC7C-24T3315	18-36 VDC	3.3/±15 VDC	0.6A/±30 mA	6A/±0.3 A	100 mA	1333 mA	90	6000µF/330µF
EC7C-24T0512	18-36 VDC	5.0/±12 VDC	0.6A/±40 mA	6A/±0.4 A	100 mA	1813 mA	91	6000µF/400µF
EC7C-24T0515	18-36 VDC	5.0/±15 VDC	0.6A/±30 mA	6A/±0.3 A	100 mA	1786 mA	91	6000µF/330µF
EC7C-48S25	36-75 VDC	2.5 VDC	0 mA	10000 mA	50 mA	585 mA	89	10000µF
EC7C-48S33	36-75 VDC	3.3 VDC	0 mA	10000 mA	50 mA	764 mA	90	10000µF
EC7C-48S05	36-75 VDC	5 VDC	0 mA	8000 mA	60 mA	906 mA	92	8000µF
EC7C-48S12	36-75 VDC	12 VDC	0 mA	3333 mA	60 mA	896 mA	93	3300µF
EC7C-48S15	36-75 VDC	15 VDC	0 mA	2666 mA	60 mA	906 mA	92	2700µF
EC7C-48D12	36-75 VDC	±12 VDC	90 mA	±1800 mA	50 mA	989 mA	91	1800µF
EC7C-48D15	36-75 VDC	±15 VDC	70 mA	±1400 mA	50 mA	962 mA	91	1400µF
EC7C-48D3305	36-75 VDC	3.3/5.0 VDC	0 mA	10A/7.5 A	50 mA	926 mA	89.5	7270µF/7270µF
EC7C-48T3312	36-75 VDC	3.3/±12 VDC	0.6A/±40 mA	6A/±0.4 A	50 mA	684 mA	89.5	6000µF/400µF
EC7C-48T3315	36-75 VDC	3.3/±15 VDC	0.6A/±30 mA	6A/±0.3 A	50 mA	682 mA	88	6000µF/330µF
EC7C-48T0512	36-75 VDC	5.0/±12 VDC	0.6A/±40 mA	6A/±0.4 A	50 mA	932 mA	88.5	6000µF/400µF
EC7C-48T0515	36-75 VDC	5.0/±15 VDC	0.6A/±30 mA	6A/±0.3 A	50 mA	903 mA	90	6000µF/330µF

Derating Curve

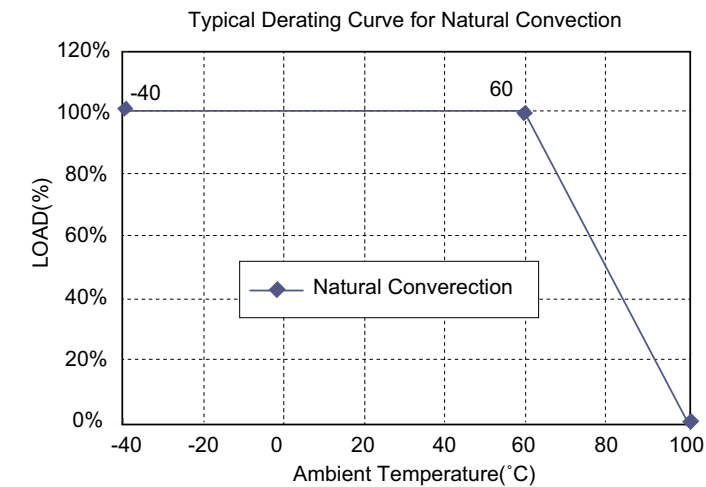

Specifications

All Specifications Typical At Nominal Line, Full Load, and 25°C Unless Otherwise Noted

INPUT SPECIFICATIONS

Input Voltage Range	12V 9-18V	24V 18-36V	48V 36-75V
Input Surge Voltage (100ms max.)	12V 25Vdc max	24V 50Vdc max.	48V 100Vdc max.
Under voltage lockout	12Vin 8.8V power up 8.0V power down	24Vin 17V power up 16V power down	48Vin 34V power up 32V power down
Positive/Negative Logic Remote On/Off (note 5 & 6)	PI Type		
Input Filter	PI Type		

GENERAL SPECIFICATIONS

Efficiency	See Table
Isolation Voltage	Input/Output...1500VDC max.
Isolation Resistance	10 ⁹ ohm min.
Isolation Capacitance	1000pF typ.
Switching Frequency	350KHz typ.
Operating Ambient Temperature	-40°C to +85°C
De-rating, Above 60°C	Linearly to Zero power at 100°C
Case Temperature (note 8)	100°C max.
Cooling	Natural Convection
Storage Temperature	-55°C to +125°C
Humidity	95% RH max. Non condensing
MTBF. MIL-STD-217F, GB, 25°C, Full Load	XXD3305 500Khrs typ. Others 700Khrs typ.
Thermal Shutdown, Case Temperature	110°C Typical
Dimensions	2.00 x 2.00 x 0.40 inches (50.8 x 50.8 x 10.2 mm)
Case Material	Black Coated Copper with Non-Conductive Base
Weight	65 g

OUTPUT SPECIFICATIONS

Voltage Accuracy	Single/Dual ±1.5% max.	Dual positive 3.3V±1.5% max., 5V±3% max.	Triple Main ±1.5% max., Auxiliary ±3.0% max.
Voltage Balance(Dual)	±2.0% max.		
Transient Response: 75% - 100% Step Load Change (Main Output)	±5% Vout nominal		
Error Band	< 300µs		
Recovery Time	Output Voltage Adjustment Range		
Output Voltage Adjustment Range	Single/Dual Vo±10%, Dual Positive±5%		
Ripple & Noise, 20MHz BW (Measured with 0.1µF MLCC)	2.5V & 3.3V & 5V 50mVpp,max., 12V&15V 75mVpp max.		
Dual ±12V	120mVpk-pk, max., ±15V 150mVpk-pk,max.		
Dual positive +3.3V /+5V	100mVpk-pk max.		
Temperature Coefficient	±0.02%/°C		
Line Regulation (note 1)	Single/Dual/ Dual positive ±0.5% max.		
Triple	Main ±1.0% max.		
Triple	Auxiliary ±3.0% max.		
Load Regulation (note 2)	Single ±0.5% max., Dual ±1.0% max.		
Dual positive(note 3)	3.3V ±1.5% max., 5V±4% max.		
Triple	Main ±1.0% max.		
Triple	Auxiliary ±4.0% max.		
Cross Regulation (note 4)	+3.3V±1.0% max. +5V±4.0% max.		
Over voltage Protection (Zener Diode Clamp)	2.5V 3.6Vdc typ.		
3.3V	3.9Vdc typ., 5V 6.2Vdc typ.		
12V	15Vdc typ., 15V 18Vdc typ.		
Output Current Limit, % Nominal Output	110%-140%		
Output Short Circuit Protection	Continuous (hiccup mode)		
Start up time	10ms typ.		

NOTE

1. Measured from high line to low line (dual positive at rated load).
2. Measured from full load to 10% load.
3. Measured from max. load to zero load, other output at zero load.
4. Measured from max. load to 10% load, other output at 10% load.
5. Logic Compatibility CMOS or open collector TTL, ref. to -Vin
Module On >3.5VDC to 75VDC or open circuit
Module Off < 1.8VDC.
6. Suffix "N" to the model number with negative logic remote On/Off
Module On < 1.8VDC
Module Off >3.5VDC to 75VDC or open circuit
7. If +/-sense is not being used, the +sense should be connected to +vout and likewise the -sense should be connected to -Vout.
8. Maximum case temperature under any operating condition should not be exceeded 100°C.

EC5E SERIES

25-30 WATT, 2:1 INPUT RANGE

Visit www.cincon.com for new releases and a wider selection of products

Features

- ◆ 30W Isolated Output
- ◆ Six-Sided Shield Metal Case
- ◆ Regulated Outputs
- ◆ Remote On/Off Control
- ◆ Efficiency to 84%
- ◆ Fixed 200KHz Switching Frequency



Mechanical Dimensions

All Dimensions in Inches (mm)
 Tolerance Inches: X.XX±0.04, X.XXX±0.010
 Millimeters: X.X±0.5, X.XX±0.25

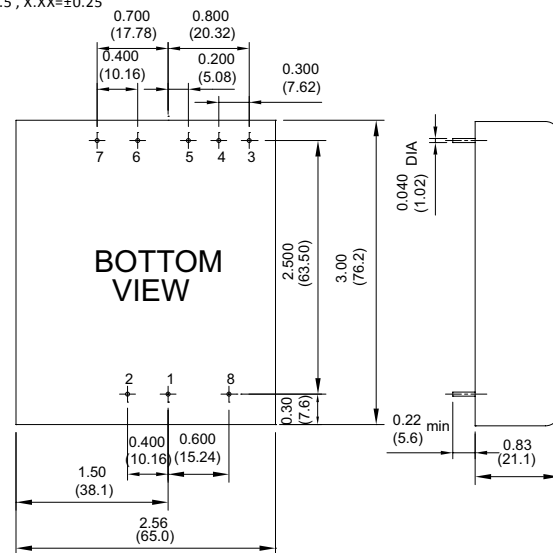

PIN CONNECTION			
PIN	Single Output	Dual Output	Triple Output
1	+Input	+Input	+Input
2	-Input	-Input	-Input
3	+Sense	+Output	+Output
4	Output Trim	Common	Common
5	-Sense	-Output	-Output
6	+Output	No Pin	+5V Output
7	-Output	No Pin	No Pin
8	Remote On/Off Control		

MODEL NUMBER	INPUT VOLTAGE	OUTPUT VOLTAGE	OUTPUT CURRENT	INPUT CURRENT		% EFF.
				NO LOAD	FULL LOAD	
EC5E01	9-18 VDC	5 VDC	5000 mA	30 mA	2700 mA	77
EC5E02	9-18 VDC	12 VDC	2500 mA	30 mA	3150 mA	79
EC5E03	9-18 VDC	15 VDC	2000 mA	30 mA	3150 mA	79
EC5E04	9-18 VDC	±12 VDC	±1250 mA	35 mA	3100 mA	81
EC5E05	9-18 VDC	±15 VDC	±1000 mA	35 mA	3100 mA	81
EC5E06	9-18 VDC	5/±12 VDC	3000/±625 mA	35 mA	3200 mA	78
EC5E07	9-18 VDC	5/±15 VDC	3000/±500 mA	35 mA	3200 mA	78
EC5E08	9-18 VDC	+5/+12/-5 VDC	3000/600/1000 mA	35 mA	2940 mA	77
EC5E11	18-36 VDC	5 VDC	5000 mA	30 mA	1350 mA	77
EC5E12	18-36 VDC	12 VDC	2500 mA	30 mA	1550 mA	81
EC5E13	18-36 VDC	15 VDC	2000 mA	30 mA	1550 mA	81
EC5E14	18-36 VDC	±12 VDC	±1250 mA	30 mA	1500 mA	84
EC5E15	18-36 VDC	±15 VDC	±1000 mA	30 mA	1500 mA	84
EC5E16	18-36 VDC	5/±12 VDC	3000/±625 mA	30 mA	1580 mA	79
EC5E17	18-36 VDC	5/±15 VDC	3000/±500 mA	30 mA	1560 mA	80
EC5E18	18-36 VDC	+5/+12/-5 VDC	3000/600/1000 mA	30 mA	1450 mA	78
EC5E21	36-72 VDC	5 VDC	5000 mA	15 mA	670 mA	78
EC5E22	36-72 VDC	12 VDC	2500 mA	15 mA	770 mA	81
EC5E23	36-72 VDC	15 VDC	2000 mA	15 mA	770 mA	81
EC5E24	36-72 VDC	±12 VDC	±1250 mA	20 mA	750 mA	84
EC5E25	36-72 VDC	±15 VDC	±1000 mA	20 mA	750 mA	84
EC5E26	36-72 VDC	5/±12 VDC	3000/±625 mA	20 mA	790 mA	79
EC5E27	36-72 VDC	5/±15 VDC	3000/±500 mA	20 mA	780 mA	80
EC5E28	36-72 VDC	+5/+12/-5 VDC	3000/600/1000 mA	20 mA	725 mA	78

Derating Curve

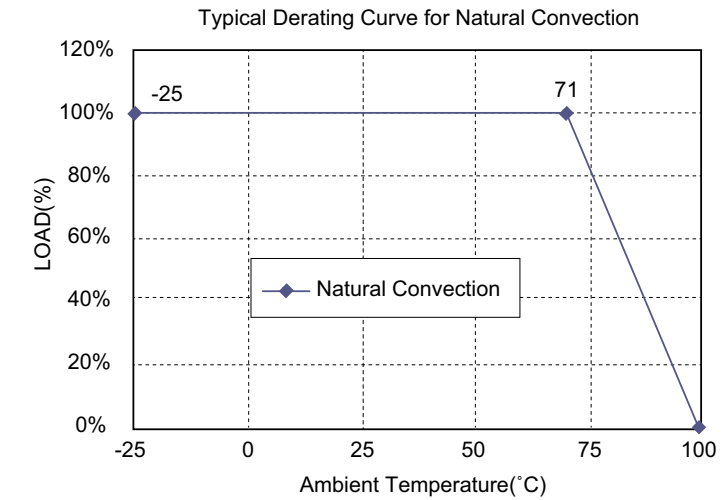

Specifications

All Specifications Typical At Nominal Line, Full Load, and 25°C Unless Otherwise Noted

INPUT SPECIFICATIONS

Input Voltage Range	12V 9-18V 24V 18-36V 48V 36-72V
Input Filter	Pi Type

OUTPUT SPECIFICATIONS

Voltage Accuracy	
Single Output	±1.0% max.
Dual +Output	±1.0% max.
Dual - Output	±3.0% max.
Triple, 5V	±1.0% max.
12V/15V	±5.0% max.
-5V	±2.0% max.
Voltage Balance (Dual)	±1.0% max.
Transient Response	
Single 25% Step Load Change	< 500µs
Dual FL-1/2L±1% Error Band	< 500µs
External Trim Adj. Range	±10%
Ripple and Noise, 20MHz BW	10mV RMS max. 75mV p-p max.
Temperature Coefficient	±0.02%/°C
Short Circuit Protection	Continuous
Line Regulation Single/Dual (note 1)	±0.2% max.
Triple	±1.0% max.
Load Regulation Single/Dual (note 2)	±1.0% max.
Triple	±5.0% max.

GENERAL SPECIFICATIONS

Efficiency	See Table
Isolation Voltage	500 VDC min.
Isolation Resistance	10 ⁹ ohms
Switching Frequency	200KHz typ.
Operating Ambient Temperature Range	-25°C to +71°C
De-rating, Above 71°C	Linearly to Zero power at 100°C
Case Temperature (note 3)	100°C max.
Cooling	Natural Convection
Storage Temperature Range	-55°C to +105°C
EMI/RFI	Six-Sided Continuous Shield
Dimensions	2.56 × 3.00 × 0.83 inches (65.0 × 76.2 × 21.1mm)
Case Material	Black Coated Copper With Non-Conductive Base
Weight	175 g

NOTE

1. Measured from high line to low line.
2. Measured from full load to 1/4 full load.
3. Maximum case temperature under any operating condition should not be exceeded 100°C.

EC6E SERIES

20-30 WATT, 4:1 INPUT RANGE

Visit www.cincon.com for new releases and a wider selection of products

Features

- ◆ 30W Isolated Output
- ◆ 4 : 1 Input Range
- ◆ Six-Sided Shield Metal Case
- ◆ Remote On/Off Control
- ◆ Efficiency to 84%
- ◆ Fixed 200KHz Switching Frequency
- ◆ Regulated Outputs



Mechanical Dimensions

All Dimensions in Inches (mm)
 Tolerance Inches: X.XX=±0.04, X.XXX=±0.010
 Millimeters: X.X=±0.5, X.XX=±0.25

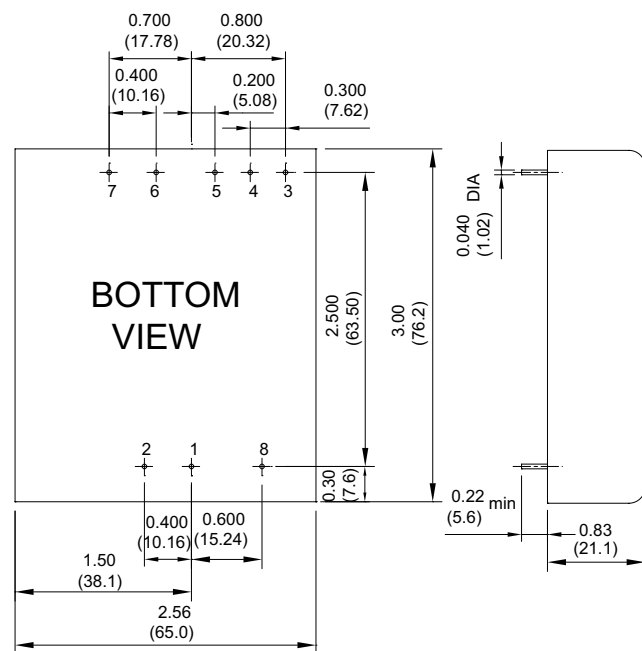

PIN CONNECTION			
PIN	Single Output	Dual Output	Triple Output
1	+Input	+Input	+Input
2	-Input	-Input	-Input
3	+Sense	+Output	+Output
4	Output Trim	Common	Common
5	-Sense	-Output	-Output
6	+Output	No Pin	+5V Output
7	-Output	No Pin	No Pin
8	Remote On/Off Control		

MODEL NUMBER	INPUT VOLTAGE	OUTPUT VOLTAGE	OUTPUT CURRENT	INPUT CURRENT		% EFF.
				NO LOAD	FULL LOAD	
EC6E01	9-36 VDC	5 VDC	5000 mA	20 mA	1350 mA	77
EC6E02	9-36 VDC	12 VDC	2500 mA	20 mA	1560 mA	80
EC6E03	9-36 VDC	15 VDC	2000 mA	20 mA	1560 mA	80
EC6E04	9-36 VDC	±12 VDC	±1250 mA	25 mA	1560 mA	80
EC6E05	9-36 VDC	±15 VDC	±1000 mA	25 mA	1560 mA	80
EC6E06	9-36 VDC	5/±12 VDC	3000/±625 mA	25 mA	1650 mA	76
EC6E07	9-36 VDC	5/±15 VDC	3000/±500 mA	25 mA	1650 mA	76
EC6E08	9-36 VDC	+5/+12/-5 VDC	3000/600/1000 mA	25 mA	1450 mA	78
EC6E11	18-72 VDC	5 VDC	5000 mA	15 mA	670 mA	78
EC6E12	18-72 VDC	12 VDC	2500 mA	15 mA	770 mA	81
EC6E13	18-72 VDC	15 VDC	2000 mA	15 mA	770 mA	81
EC6E14	18-72 VDC	±12 VDC	±1250 mA	20 mA	750 mA	84
EC6E15	18-72 VDC	±15 VDC	±1000 mA	20 mA	750 mA	84
EC6E16	18-72 VDC	5/±12 VDC	3000/±625 mA	20 mA	790 mA	79
EC6E17	18-72 VDC	5/±15 VDC	3000/±500 mA	20 mA	790 mA	80
EC6E18	18-72 VDC	+5/+12/-5 VDC	3000/600/1000 mA	20 mA	725 mA	78

Derating Curve

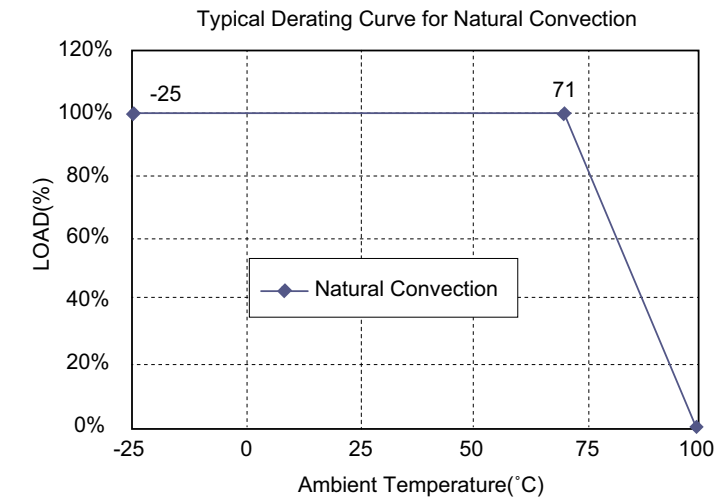

Specifications

All Specifications Typical At Nominal Line, Full Load, and 25°C Unless Otherwise Noted

INPUT SPECIFICATIONS

Input Voltage Range	24V 9-36V 48V 18-72V
Input Filter	Pi Type

OUTPUT SPECIFICATIONS

Voltage Accuracy	
Single Output	±1.0% max.
Dual +Output	±1.0% max.
Dual - Output	±3.0% max.
Triple 5V	±1.0% max.
12V/15V	±5.0% max.
-5V	±2.0% max.
Voltage Balance (Dual)	±1.0% max.
Transient Response	
Single 25% Step Load Change	< 500µs
Dual FL-1/2L±1% Error Band	< 500µs
External Trim Adj. Range	±10%
Ripple and Noise, 20MHz BW	10mV RMS max. 75mV p-p max.
Temperature Coefficient	±0.02%/°C
Short Circuit Protection	Continuous
Line Regulation Single/Dual (note 1)	±0.2% max.
Triple	±1.0% max.
Load Regulation Single/Dual (note 2)	±1.0% max.
Triple	±5.0% max.

GENERAL SPECIFICATIONS

Efficiency	See Table
Isolation Voltage	500 VDC min.
Isolation Resistance	10 ⁹ ohms
Switching Frequency	200KHz typ.
Operating Ambient Temperature Range	-25°C to +71°C
De-rating, Above 71°C	Linearly to Zero power at 100°C
Case Temperature (note 3)	100°C max.
Cooling	Natural Convection
Storage Temperature Range	-55°C to +105°C
EMI/RFI	Six-Sided Continuous Shield
Dimensions	2.56 × 3.00 × 0.83 inches (65.0 × 76.2 × 21.1 mm)
Case Material	Black Coated Copper With Non-Conductive Base
Weight	175 g

NOTE

1. Measured from high line to low line.
2. Measured from full load to 1/4 full load.
3. Maximum case temperature under any operating condition should not be exceeded 100°C.

Rapid Standard-Modification, Value Added & Customized Power Supplies. Cincon offers a high degree of flexibility in product designs.

Cincon provides a broad range of standard products that address the needs of many applications, there are occasions when a standard product doesn't address all your application requirements.

By years of experience in developing our customers with solutions on demand, do not hesitate to talk to Cincon to obtain your preferred products.

POWER SUPPLY - REQUEST FOR QUOTE - by fax +886 2 2702 9852

Company _____ Date _____

First Name _____ Last Name _____

Country _____ City _____

Address _____

Telephone _____ Fax _____

E-mail _____

Product Type

Application

Output Voltages

Output Currents

Input Voltages

Efficiency

Isolation

Protection

Storage / Operating Temperature Range

Safety Standard

EMC Standard

Mechanical Description

Remarks

Cincon Headquarters

14F, No. 306, Section 4, Hsin Yi Rd., Taipei, Taiwan
Tel: (886-2) 2708-6210
E-mail: sales@cincon.com.tw

Cincon USA

1655 Mesa Verde Ave, Ste 180
Ventura, CA 93003 USA
Tel: (805) 639-3350
E-mail: info@cincon.com

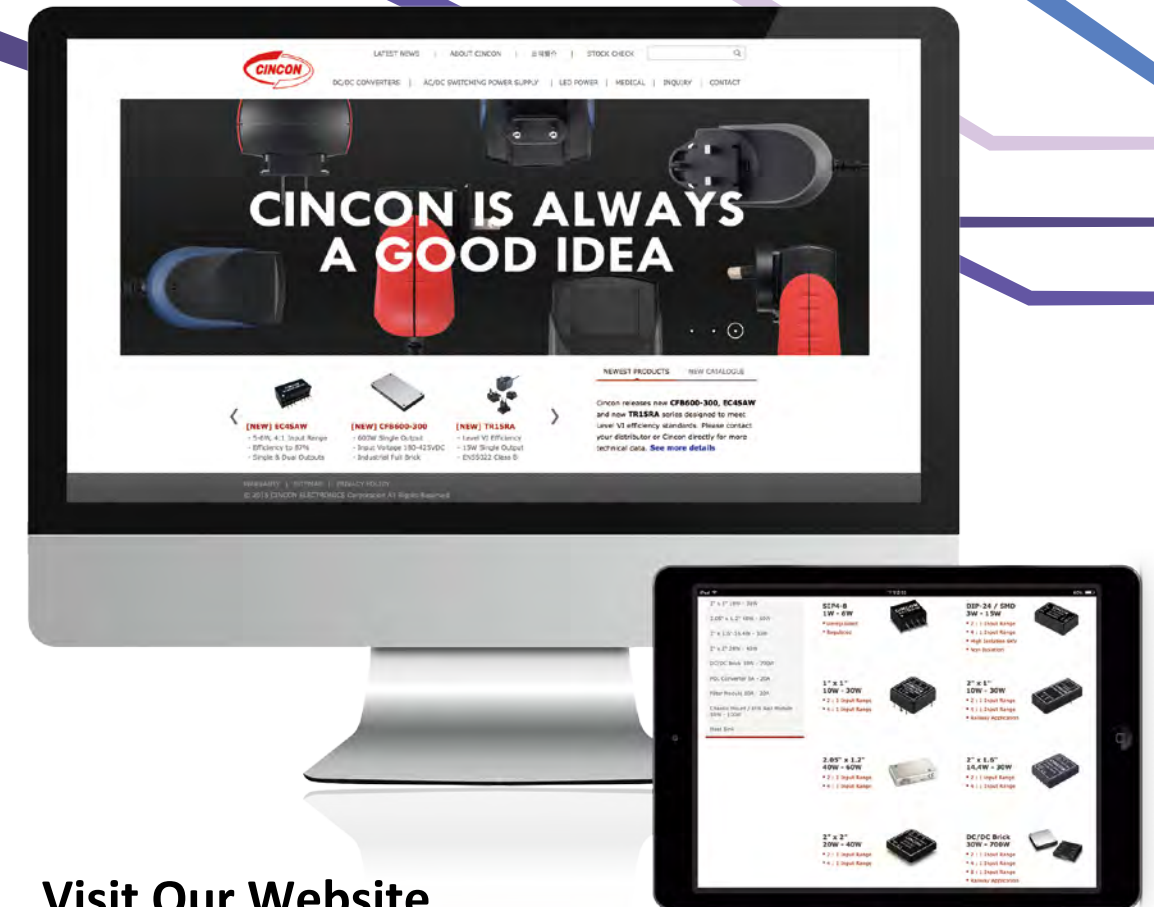

Visit Our Website
WWW.CINCON.COM

On Cincon Website

- ✓ You can download latest datasheets & application notes
- ✓ You can find all new product releases and latest news
- ✓ You can find Cincon sales representative & distributors
- ✓ You can check stock and send product inquiry to us

Let Cincon Power Your Idea

CINCON ELECTRONICS

LOW POWER 1-60W DC-DC CONVERTER CATALOG 2016

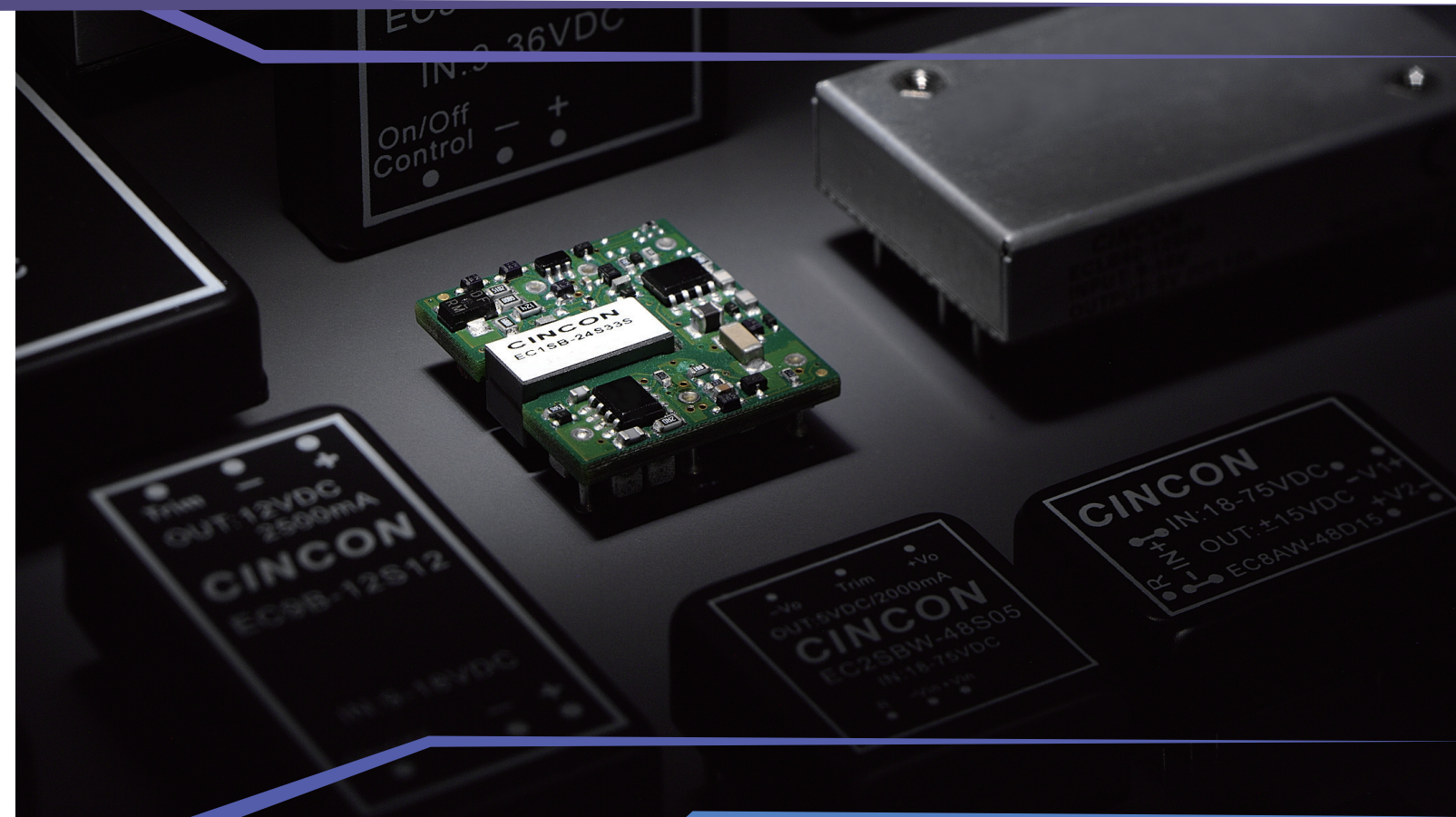

CINCON HEADQUARTERS

14F , No. 306, Section 4, Hsin Yi Road Taipei, Taiwan, R.O.C.
Tel : (886-2) 2708-6210 | Fax : (886-2) 2702-9852
E-mail : sales@cincon.com.tw

CINCON USA

1655 Mesa Verde Ave, Ste 180 Ventura , CA 93003 USA
Tel : (805) 639-3350 | Fax : (805) 639-4101
E-mail : info@cincon.com

WWW.CINCON.COM



X-ON Electronics

Largest Supplier of Electrical and Electronic Components

Click to view similar products for [Isolated DC/DC Converters](#) category:

Click to view products by [Cincon](#) manufacturer:

Other Similar products are found below :

[ESM6D044440C05AAQ](#) [FMD15.24G](#) [PSL486-7LR](#) [PSR152.5-7IR](#) [Q48T30020-NBB0](#) [AVO240-48S12B-6L](#) [AVO250-48S28B-6L](#) [NAN-0505](#) [HW-L16D](#) [JAHW100Y1](#) [217-1617-001](#) [22827](#) [SPB05C-12](#) [SQ24S15033-PS0S](#) [18952](#) [19-130041](#) [CE-1003](#) [CE-1004](#) [GQ2541-7R](#) [PSE1000DCDC-12V](#) [RDS180245](#) [MAU228](#) [419-2065-201](#) [449-2075-101](#) [TME 0303S](#) [TME 0505S](#) [TME 1205S](#) [TME 1212S](#) [TME 2405S](#) [TME 2412S](#) [V300C24C150BG](#) [419-2062-200](#) [419-2063-401](#) [419-2067-101](#) [419-2067-501](#) [419-2068-001](#) [DCG40-5G](#) [DFC15U48D15](#) [449-2067-000](#) [XGS-0512](#) [XGS-1205](#) [XGS-1212](#) [XGS-2412](#) [XGS-2415](#) [XKS-1215](#) [033456](#) [NCT1000N040R050B](#) [SPB05B-15](#) [SPB05C-15](#) [TME 0509S](#)