

---

## Atmel AVR600: STK600 Expansion, Routing and Socket Boards

---

### Atmel Microcontrollers

#### Introduction

---

This application note describes the process of developing new routing, socket and expansion cards for the Atmel STK®600. It also describes the physical parameters for creating such cards.

The STK600 starter kit from Atmel has a sandwich design to match a specific part package and pin out to the generic pin headers. It also features an expansion area where most part pins are available.

While the variety of IC packages is relatively limited, the number of possible pinouts increases rapidly with the number of pins. I.e. a 6-pin IC can have 720 (6!) different pinouts!

The routing / socket card design provides a lowcost solution to support upcoming devices as the socket is the cost driving factor.

STK600 users might also want to create their own routing cards to include specialized hardware to prototype their own design.

**Figure 1. STK600 router and socket card.**



## Table of Contents

---

1. Routing Cards .....	3
1.1 Connector footprints.....	3
1.2 Physical dimensions and component placement .....	4
1.3 Atmel STK600 socket connectors pinout .....	5
1.3.1 Signal descriptions.....	8
2. Socket Cards .....	10
2.1 Power design issues .....	10
2.2 Connector MPN.....	10
2.3 Physical dimensions and component placement .....	10
3. Expansion Cards.....	11
3.1 Connector MPN.....	11
3.2 Physical dimensions and component placement .....	12
3.3 Atmel STK600 expansion connectors pinout .....	13
4. ID System .....	17
4.1 Signal usage .....	17
4.2 ID functions .....	18
4.3 Examples .....	19
5. Design Example.....	20
6. Revision History .....	22

# 1. Routing Cards

The routing cards sit between the generic socket card and the Atmel STK600. It has one pair of electric pads underneath to mate with the STK600 spring loaded connector, and one pair of pads on top where the socket card connector connects. A part specific card with the target IC soldered on can be viewed as a routing card without the top pads.

## 1.1 Connector footprints

A routing card should have pads to mate with the following spring loaded connectors:

**Table 1-1. Router card connectors.**

Manufacturer and MPN	Quantity	Comment
SAMTEC, FSI-140-03-G-D-AD	2	80-pins to socket card (top)
SAMTEC, FSI-150-03-G-D-AD	2	100-pins to STK600 (bottom)

**Figure 1-1. PCB land pattern for mating to FSI connectors.**

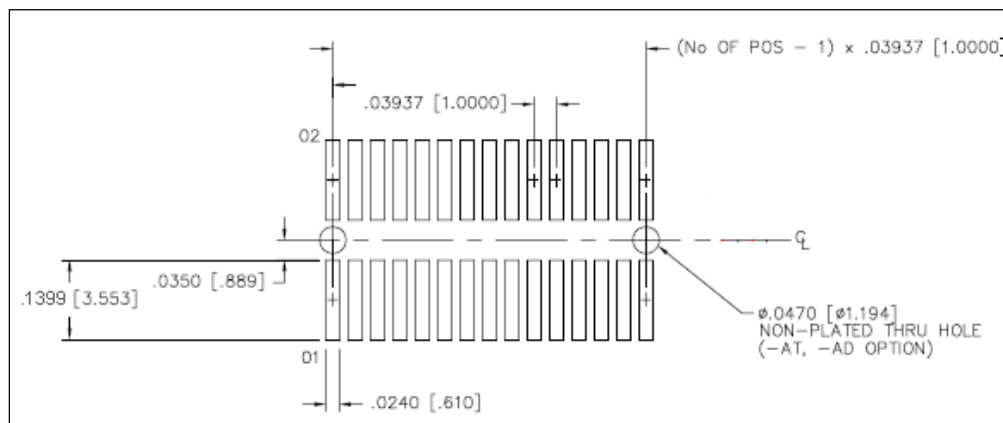

## 1.2 Physical dimensions and component placement

Figure 1-2. Routing card connector pad placement and dimensions.

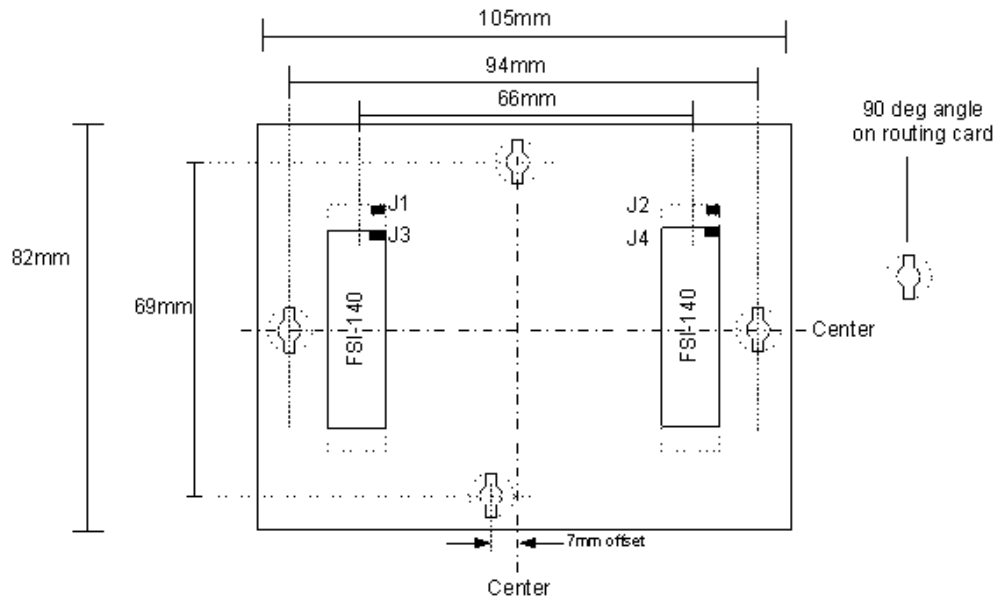
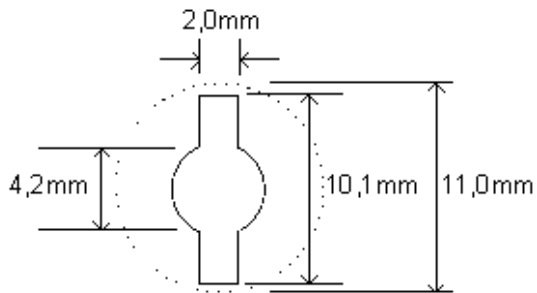

Figure 1-3. Clip hole dimensions.



The board thickness should be 1.6mm to be compatible with the clips.

Note: Components on the main board might conflict with through hole mounted or secondary side mounted components. Areas with such components are highlighted in [Figure 1-4](#).

Figure 1-4. Height restricted areas due to main board components.

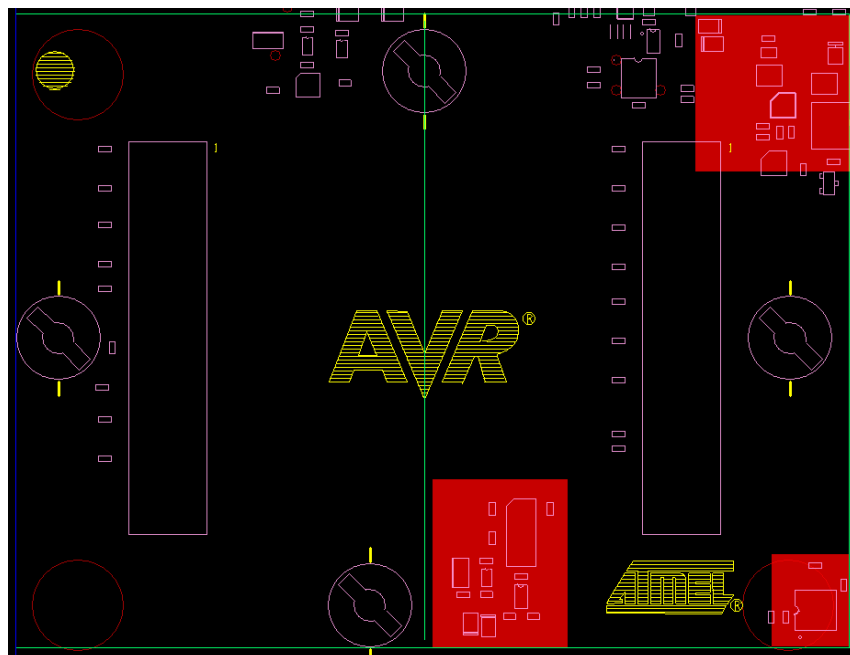

### 1.3 Atmel STK600 socket connectors pinout

Figure 1-5 shows the pinout for the STK600 headers. This corresponds to the routing card connectors J1 and J2.

Figure 1-5. STK600 socket connectors' pinout.

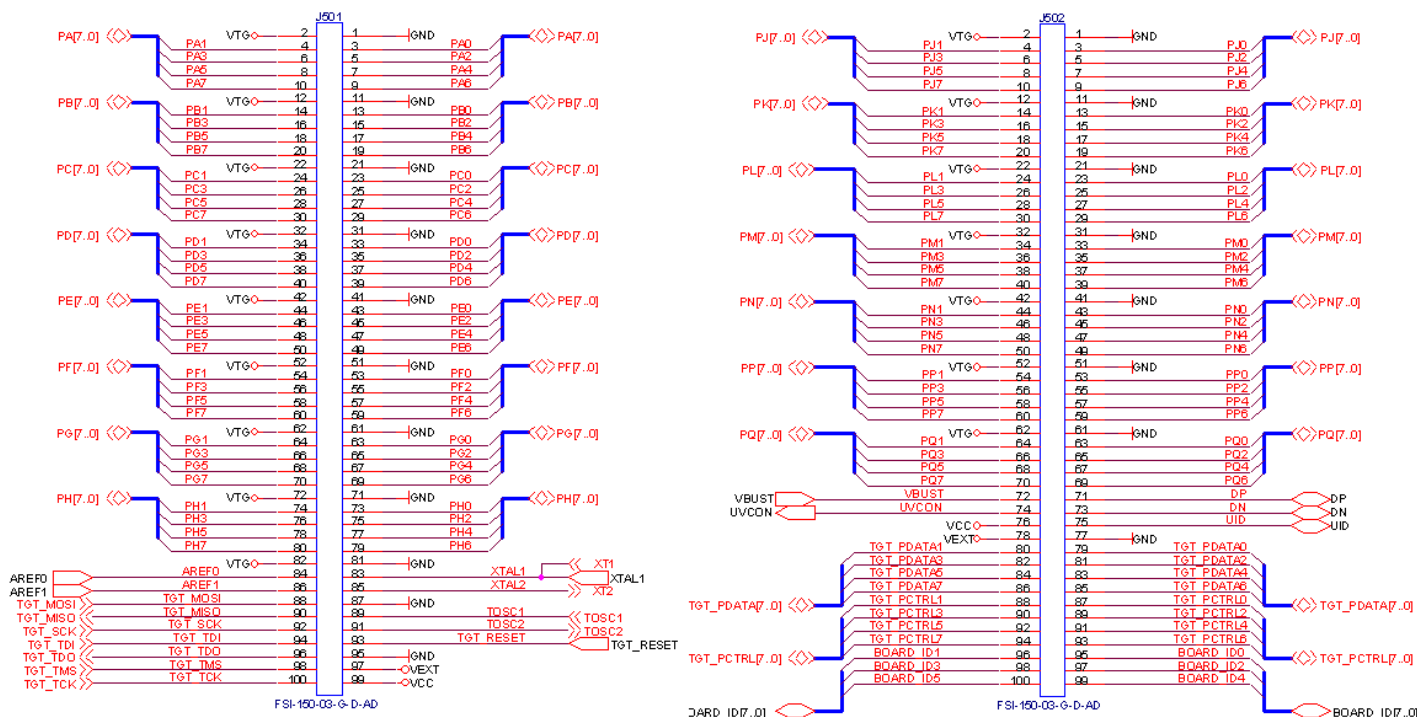

**Table 1-2. Atmel STK600 J201 left, routing card connector J1 pinout.**

Signal name	Pin number		Signal name
VTG	2	1	GND
PA1	4	3	PA0
PA3	6	5	PA2
PA5	8	7	PA4
PA7	10	9	PA6
VTG	12	11	GND
PB1	14	13	PB0
PB3	16	15	PB2
PB5	18	17	PB4
PB7	20	19	PB6
VTG	22	21	GND
PC1	24	23	PC0
PC3	26	25	PC2
PC5	28	27	PC4
PC7	30	29	PC6
VTG	32	31	GND
PD1	34	33	PD0
PD3	36	35	PD2
PD5	38	37	PD4
PD7	40	39	PD6
VTG	42	41	GND
PE1	44	43	PE0
PE3	46	45	PE2
PE5	48	47	PE4
PE7	50	49	PE6
VTG	52	51	GND
PF1	54	53	PF0
PF3	56	55	PF2
PF5	58	57	PF4
PF7	60	59	PF6
VTG	62	61	GND
PG1	64	63	PG0
PG3	66	65	PG2
PG5	68	67	PG4
PG7	70	69	PG6
VTG	72	71	GND
PH1	74	73	PH0
PH3	76	75	PH2
PH5	78	77	PH4

PH7	80	79	PH6
VTG	82	81	GND
AREF0	84	83	XTAL1
AREF1	86	85	XTAL2
TGT_MOSI	88	87	GND
TGT_MISO	90	89	TOSC1
TGT_SCK	92	91	TOSC2
TDI	94	93	TGT_RESET
TDO	96	95	GND
TMS	98	97	Vext
TCK	100	99	Vcc

**Table 1-3. Atmel STK600 J202 right, routing card connector J2 pinout.**

Signal name	Pin number		Signal name
VTG	2	1	GND
PJ1	4	3	PJ0
PJ3	6	5	PJ2
PJ5	8	7	PJ4
PJ7	10	9	PJ6
VTG	12	11	GND
PK1	14	13	PK0
PK3	16	15	PK2
PK5	18	17	PK4
PK7	20	19	PK6
VTG	22	21	GND
PL1	24	23	PL0
PL3	26	25	PL2
PL5	28	27	PL4
PL7	30	29	PL6
VTG	32	31	GND
PM1	34	33	PM0
PM3	36	35	PM2
PM5	38	37	PM4
PM7	40	39	PM6
VTG	42	41	GND
PN1	44	43	PN0
PN3	46	45	PN2
PN5	48	47	PN4
PN7	50	49	PN6
VTG	52	51	GND
PP1	54	53	PP0

PP3	56	55	PP2
PP5	58	57	PP4
PP7	60	59	PP6
VTG	62	61	GND
PQ1	64	63	PQ0
PQ3	66	65	PQ2
PQ5	68	67	PQ4
PQ7	70	69	PQ6
VBUST	72	71	DP
UVCON	74	73	DN
Vcc	76	75	UID
Vext	78	77	GND
TGT_PDATA1	80	79	TGT_PDATA0
TGT_PDATA3	82	81	TGT_PDATA2
TGT_PDATA5	84	83	TGT_PDATA4
TGT_PDATA7	86	85	TGT_PDATA6
TGT_PCTRL1	88	87	TGT_PCTRL0
TGT_PCTRL3	90	89	TGT_PCTRL2
TGT_PCTRL5	92	91	TGT_PCTRL4
TGT_PCTRL7	94	93	TGT_PCTRL6
BOARD_ID1	96	95	BOARD_ID0
BOARD_ID3	98	97	BOARD_ID2
BOARD_ID5	100	99	BOARD_ID4

### 1.3.1 Signal descriptions

**Table 1-4. Socket card connector pin description.**

Atmel STK600 signal name	MCU	Comment
PAX, PBx etc	PAX, PBx etc	1-to-1 MCU pin mapping
VTG	Vcc	Target supply rail controlled by Atmel AVR Studio® / STK600
GND	GND	
AREF <sub>x</sub>	AREF	Analog reference voltage, controlled by AVR Studio / STK600
XTAL <sub>x</sub>	XTAL <sub>x</sub>	Clock pins connected to oscillator on STK600
TGT_SCK, TGT_MISO, TGT_MOSI	ISP pins	ISP programming interface
TGT_TDI, TGT_TDO, TGT_TMS, TGT_TCK	JTAG pins	JTAG programming interface
VBUST	VBUS	VBUS (sense) for USB
UID	UID	ID pin for USB OTG
UVCON	UVCON	USB VBUS generation control for USB OTG. A low level on this signal enables VBUS generation
DP, DN	DP, DN	USB differential pair
TGT_PDATA(0-7)	(HV) data pins	Data pins for high voltage (PP/HVSP) programming



TGT_CTRL0	(HV) BS2	Control signals for High voltage Parallel Programming / Serial Programming. Refer to AVR datasheet for further information. On AVR's with common XA1/BS2, XA1 is used. On AVR's with common BS1/PAGEL, BS1 is used.
TGT_CTRL1	(HV) Ready/Busy	
TGT_CTRL2	(HV) /OE	
TGT_CTRL3	(HV) /WR	
TGT_CTRL4	(HV) BS1	
TGT_CTRL5	(HV) XA0	
TGT_CTRL6	(HV) XA1	
TGT_CTRL7	(HV) PAGEL	
BOARD_IDn	none	ID system for router / socket / expansion cards, see <a href="#">Chapter 4 - ID System</a>

- Notes:
1. Not all AVR will have every pin (ex. two aref pins, tosc or usb).
  2. A MCU pin will fan-out to both Pnx pin and to the programming interface(s) located at that pin.

## 2. Socket Cards

Socket cards route each pin from the IC socket to separate pins on the spring loaded connectors on the bottom side, facing the routing card.

### 2.1 Power design issues

As all routing is handled by the routing card, even power lines and power decoupling is ignored at the socket card. This produces less than ideal power design, which may lead to unwanted noise, ground bounce, and other effects. It should therefore be expected that heavily loaded designs cannot run at full speed on the Atmel STK600. Likewise, such power design is not recommended for custom designs.

### 2.2 Connector MPN

Table 2-1. Socket card connector.

Manufacturer and MPN	Quantity	Comment
SAMTEC, FSI-140-03-G-D-AD	2	Spring loaded 80-pin connector

### 2.3 Physical dimensions and component placement

Figure 2-1. Socket card connector placement and dimensions.

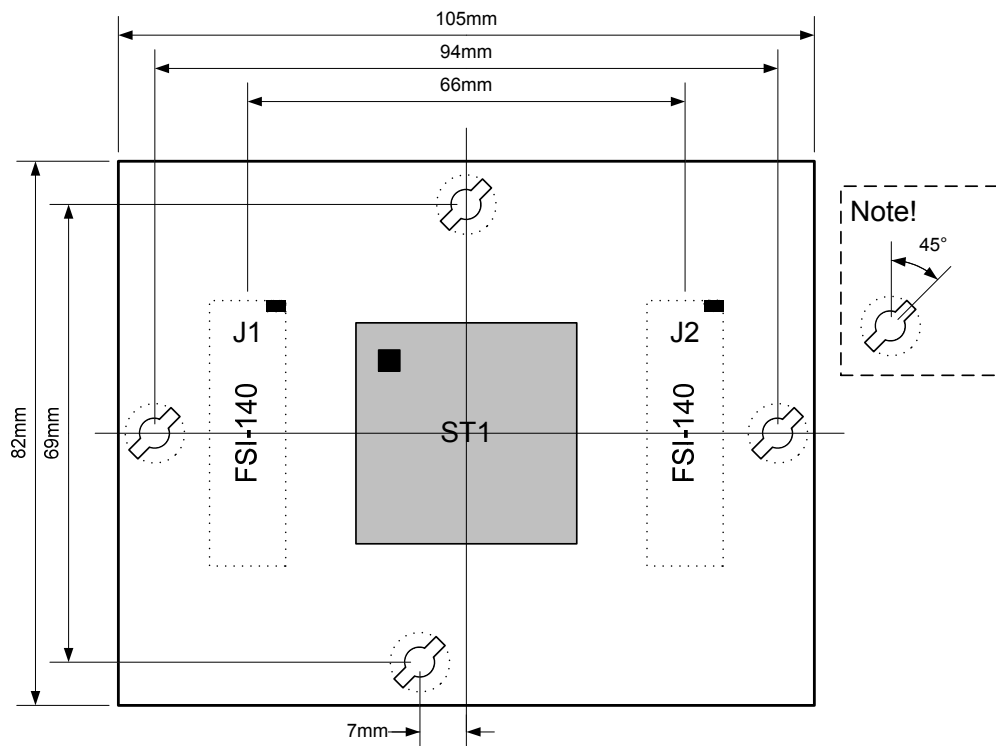

The board thickness should be 1.6mm to be compatible with the clips.

### 3. Expansion Cards

The Atmel STK600 features an expansion area where cards for custom peripherals like memory expansion, LCD etc can be placed. STK600 routes all part pins and power to the expansion card connectors.

#### 3.1 Connector MPN

Table 3-1. Expansion card connector.

Manufacturer and MPN	Quantity	Comment
FCI, 61082-101402LF	2	

### 3.2 Physical dimensions and component placement

Figure 3-1. Expansion card connector placement and dimensions.

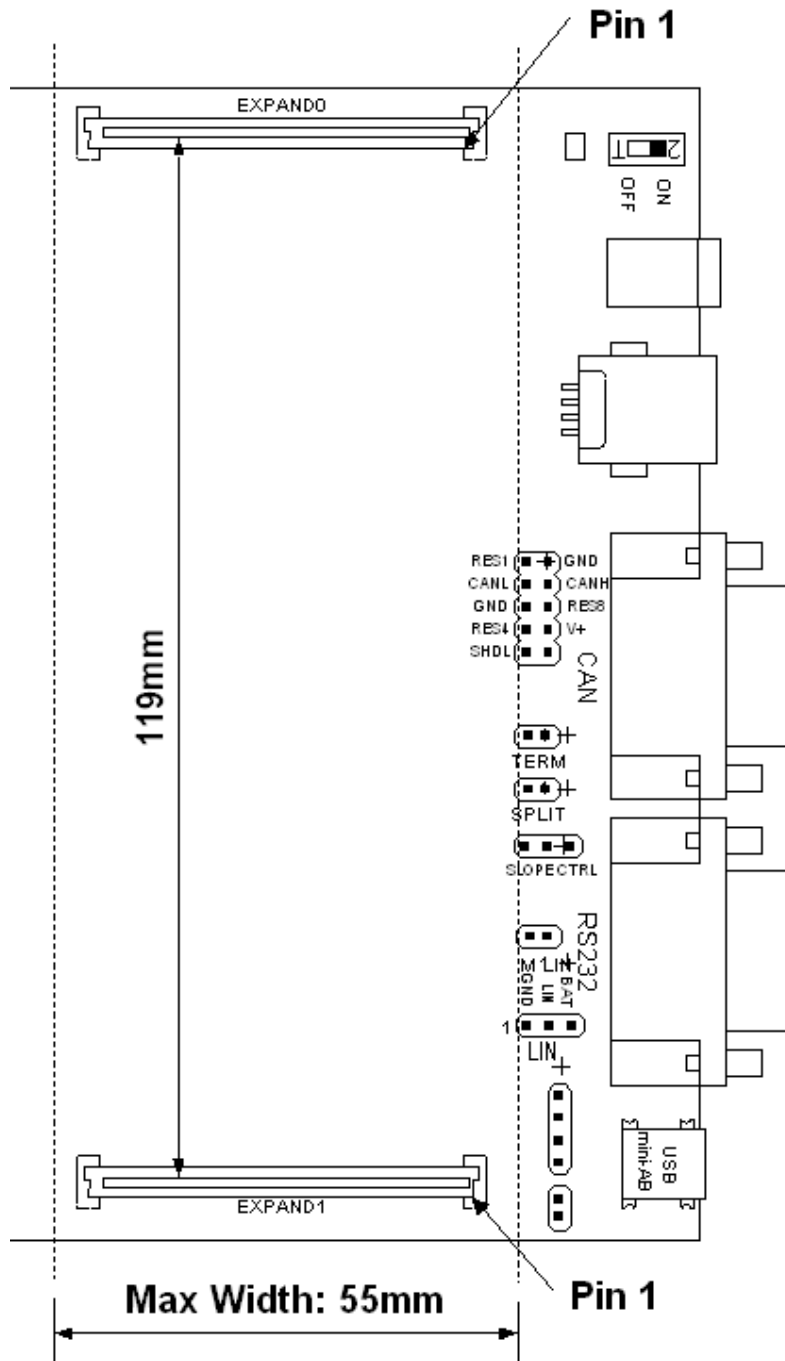

There is no requirement to board thickness.

### 3.3 Atmel STK600 expansion connectors pinout

Figure 3-2. Pinout for expansion connectors.

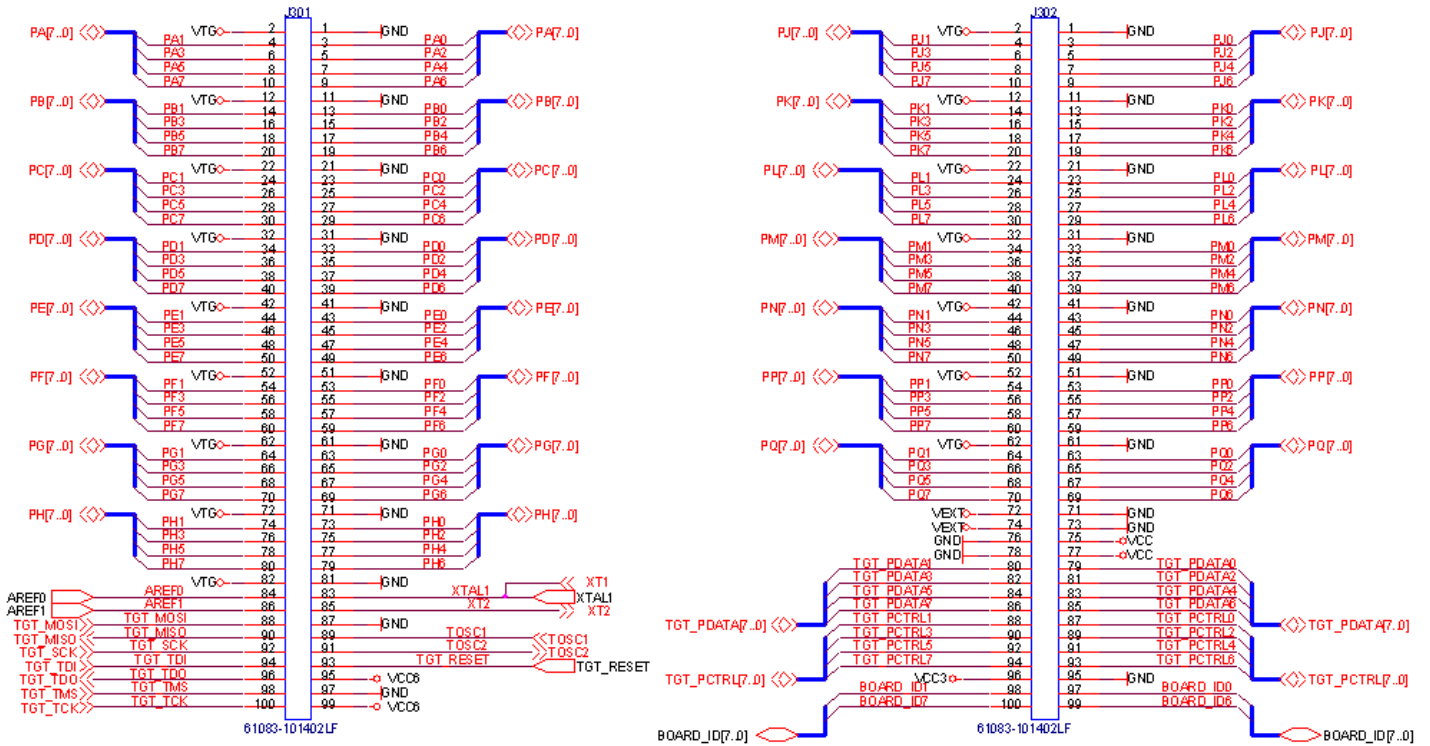

Table 3-2. STK600 J301 “expand0” connector pinout.

Signal name	Pin number		Signal name
VTG	2	1	GND
PA1	4	3	PA0
PA3	6	5	PA2
PA5	8	7	PA4
PA7	10	9	PA6
VTG	12	11	GND
PB1	14	13	PB0
PB3	16	15	PB2
PB5	18	17	PB4
PB7	20	19	PB6
VTG	22	21	GND
PC1	24	23	PC0
PC3	26	25	PC2
PC5	28	27	PC4
PC7	30	29	PC6
VTG	32	31	GND
PD1	34	33	PD0

PD3	36	35	PD2
PD5	38	37	PD4
PD7	40	39	PD6
VTG	42	41	GND
PE1	44	43	PE0
PE3	46	45	PE2
PE5	48	47	PE4
PE7	50	49	PE6
VTG	52	51	GND
PF1	54	53	PF0
PF3	56	55	PF2
PF5	58	57	PF4
PF7	60	59	PF6
VTG	62	61	GND
PG1	64	63	PG0
PG3	66	65	PG2
PG5	68	67	PG4
PG7	70	69	PG6
VTG	72	71	GND
PH1	74	73	PH0
PH3	76	75	PH2
PH5	78	77	PH4
PH7	80	79	PH6
VTG	82	81	GND
AREF0	84	83	XTAL1
AREF1	86	85	XTAL2
TGT_MOSI	88	87	GND
TGT_MISO	90	89	TOSC1
TGT_SCK	92	91	TOSC2
TDI	94	93	TGT_RESET
TDO	96	95	Vcc6
TMS	98	97	GND
TCK	100	99	Vcc6

**Table 3-3. Atmel STK600 J302 “expand1” connector pinout.**

Signal name	Pin number		Signal name
VTG	2	1	GND
PJ1	4	3	PJ0
PJ3	6	5	PJ2
PJ5	8	7	PJ4
PJ7	10	9	PJ6

VTG	12	11	GND
PK1	14	13	PK0
PK3	16	15	PK2
PK5	18	17	PK4
PK7	20	19	PK6
VTG	22	21	GND
PL1	24	23	PL0
PL3	26	25	PL2
PL5	28	27	PL4
PL7	30	29	PL6
VTG	32	31	GND
PM1	34	33	PM0
PM3	36	35	PM2
PM5	38	37	PM4
PM7	40	39	PM6
VTG	42	41	GND
PN1	44	43	PN0
PN3	46	45	PN2
PN5	48	47	PN4
PN7	50	49	PN6
VTG	52	51	GND
PP1	54	53	PP0
PP3	56	55	PP2
PP5	58	57	PP4
PP7	60	59	PP6
VTG	62	61	GND
PQ1	64	63	PQ0
PQ3	66	65	PQ2
PQ5	68	67	PQ4
PQ7	70	69	PQ6
Vext	72	71	GND
Vext	74	73	GND
GND	76	75	Vcc
GND	78	77	Vcc
TGT_PDATA1	80	79	TGT_PDATA0
TGT_PDATA3	82	81	TGT_PDATA2
TGT_PDATA5	84	83	TGT_PDATA4
TGT_PDATA7	86	85	TGT_PDATA6
TGT_PCTRL1	88	87	TGT_PCTRL0
TGT_PCTRL3	90	89	TGT_PCTRL2
TGT_PCTRL5	92	91	TGT_PCTRL4

TGT_PCTRL7	94	93	TGT_PCTRL6
Vcc3	96	95	GND
BOARD_ID1	98	97	BOARD_ID0
BOARD_ID7	100	99	BOARD_ID6



## 4. ID System

The Atmel STK600 features an ID system to identify which routing, socket and expansion card is attached. The STK600 can impose voltage limitations based on the IDs, and Atmel AVR Studio will notify the user if the combination is incorrect.

The ID system consists of two common output and two board unique input signals. Each input is one of sixteen possible values based in the input signals – giving a total ID space of 256.

Three IDs are reserved for custom use and can be implemented without use of ICs.

**Table 4-1. IDs reserved for custom use.**

Type	ID
Board limited to 1.8V	0xCA
Board limited to 3.3V	0xCC
No limit on voltage	0xCF

The ID 0xff indicates no board present.

### 4.1 Signal usage

**Table 4-2. ID system signal usage.**

Name	Direction	Function
BOARD_ID0	Output (A)	Common output to functions
BOARD_ID1	Output (B)	Common output to functions
BOARD_ID2	Input	Input from routing card
BOARD_ID3	Input	Input from routing card
BOARD_ID4	Input	Input from socket card
BOARD_ID5	Input	Input from socket card
BOARD_ID6	Input	Input from expansion card
BOARD_ID7	Input	Input from expansion card

## 4.2 ID functions

The functions and their output according to input A and B:

B	A	0	1	2	3	4	5	6	7	8	9	10	11	12	13	14	15
0	0	0	1	0	1	0	1	0	1	0	1	0	1	0	1	0	1
0	1	0	0	1	1	0	0	1	1	0	0	1	1	0	0	1	1
1	0	0	0	0	0	1	1	1	1	0	0	0	0	1	1	1	1
1	1	0	0	0	0	0	0	0	0	1	1	1	1	1	1	1	1

Functions as logic expressions:

Function	Expression	ID
0	0	0x0
1	$\overline{A + B}$	0x1
2	$A\overline{B}$	0x2
3	$\overline{B}$	0x3
4	$\overline{A}B$	0x4
5	$\overline{A}$	0x5
6	$A \oplus B$	0x6
7	$\overline{A}B$	0x7
8	$AB$	0x8
9	$\overline{A \oplus B}$	0x9
10	$A$	0xA
11	$\overline{B} + AB$	0xB
12	$B$	0xC
13	$B + \overline{A} \cdot \overline{B}$	0xD
14	$A + B$	0xE
15	1	0xF

### 4.3 Examples

For a socket card to report the ID 0xCA:

Route BOARD\_ID1 to BOARD\_ID4 and BOARD\_ID0 to BOARD\_ID5

Figure 4-1. Socket card ID example.

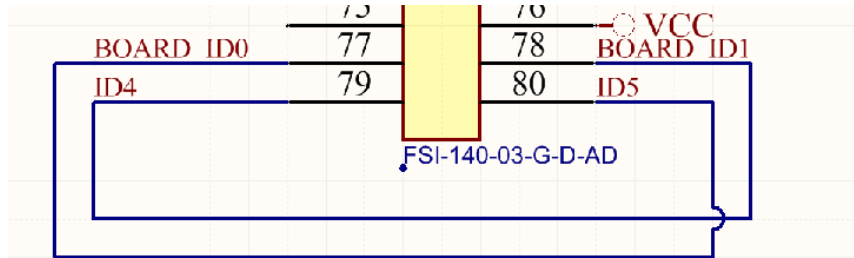

For an expansion card to report the ID 0xCF:

Route BOARD\_ID0 to BOARD\_ID6 and VCC to BOARD\_ID7

Figure 4-2. Expansion card ID example.

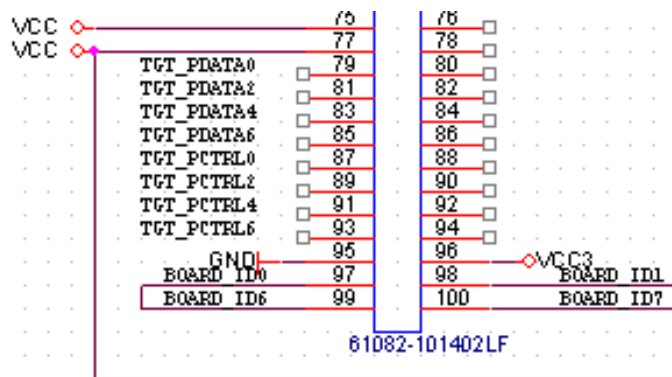

For a router card to report the ID 0xCC:

Route BOARD\_ID1 to both BOARD\_ID2 and BOARD\_ID3.

Figure 4-3. Routing card ID example.

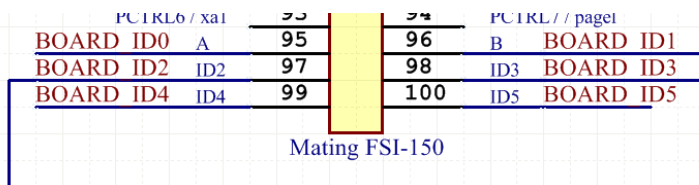

## 5. Design Example

To support a new package type one would typically start with designing the socket card. The pinout between the socket card and routing card is not defined and left to the designer. An example is given in Figure 5-1.

Next is the design of the routing card (Figure 5-3). The routing card's role is to connect each pin from the socket card to the corresponding pin on the Atmel STK600. In addition to decoupling etc, the routing card should also fan-out the correct signals to programming headers.

Each card in the stack has its own board\_id pins; the routing card is responsible for passing on the signal to the socket card.

Figure 5-1. Schema capture of socket card.

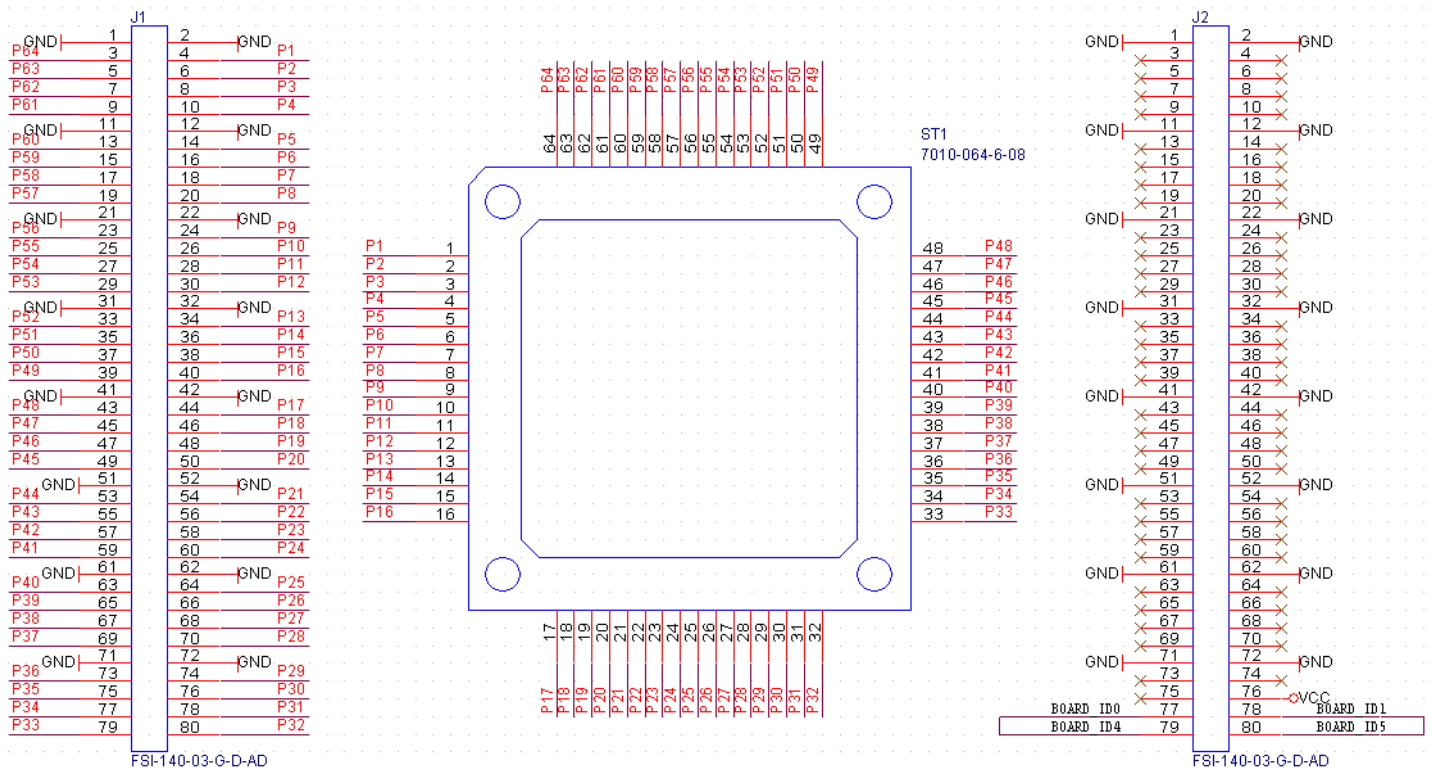

Both the socket and routing card must also include the clip holes:

Figure 5-2. Clip holes included in schematic.

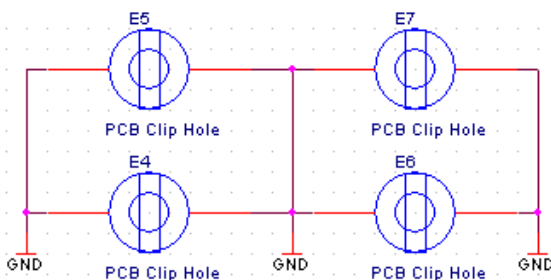
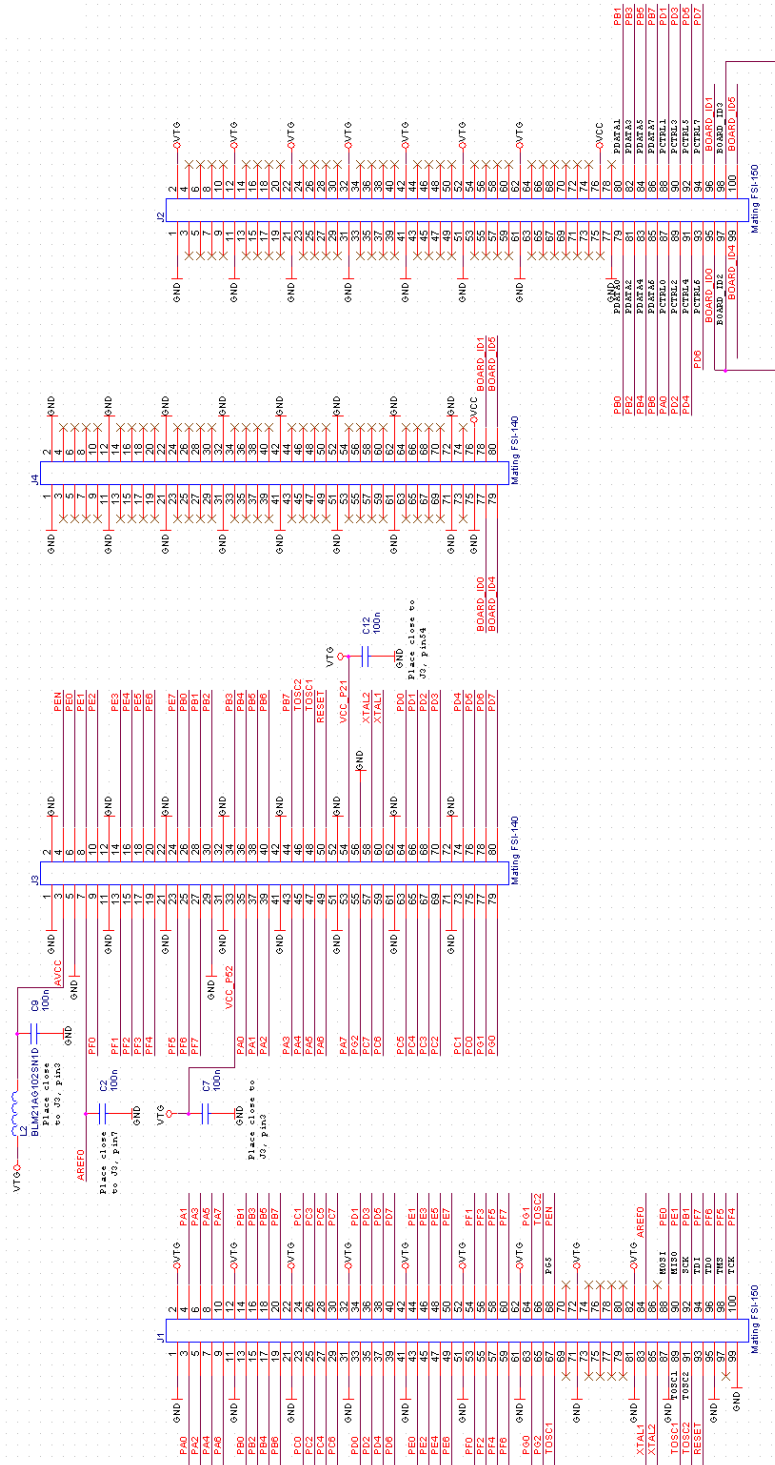

Figure 5-3. Schema capture of routing card.

STK600 Routing Card RC064M-9



Copyright © 2008, Atmel Corporation

## 6. Revision History

Doc. Rev.	Date	Comments
8170C	03/2013	Example schematics for the ID system are updated
8170B	12/2010	
8170A	10/2008	Initial document release

**Atmel Corporation**

1600 Technology Drive  
San Jose, CA 95110  
USA

**Tel:** (+1)(408) 441-0311

**Fax:** (+1)(408) 487-2600

[www.atmel.com](http://www.atmel.com)

**Atmel Asia Limited**

Unit 01-5 & 16, 19F  
BEA Tower, Millennium City 5  
418 Kwun Tong Road  
Kwun Tong, Kowloon  
HONG KONG

**Tel:** (+852) 2245-6100

**Fax:** (+852) 2722-1369

**Atmel Munich GmbH**

Business Campus  
Parking 4  
D-85748 Garching b. Munich  
GERMANY

**Tel:** (+49) 89-31970-0

**Fax:** (+49) 89-3194621

**Atmel Japan G.K.**

16F Shin-Osaki Kangyo Building  
1-6-4 Osaki, Shinagawa-ku  
Tokyo 141-0032  
JAPAN

**Tel:** (+81)(3) 6417-0300

**Fax:** (+81)(3) 6417-0370

© 2013 Atmel Corporation. All rights reserved. / Rev.: 8170C-AVR-03/2013

Atmel®, Atmel logo and combinations thereof, AVR®, AVR Studio®, Enabling Unlimited Possibilities®, STK®, and others are registered trademarks or trademarks of Atmel Corporation or its subsidiaries. Other terms and product names may be trademarks of others.

Disclaimer: The information in this document is provided in connection with Atmel products. No license, express or implied, by estoppel or otherwise, to any intellectual property right is granted by this document or in connection with the sale of Atmel products. EXCEPT AS SET FORTH IN THE ATMEL TERMS AND CONDITIONS OF SALES LOCATED ON THE ATMEL WEBSITE, ATMEL ASSUMES NO LIABILITY WHATSOEVER AND DISCLAIMS ANY EXPRESS, IMPLIED OR STATUTORY WARRANTY RELATING TO ITS PRODUCTS INCLUDING, BUT NOT LIMITED TO, THE IMPLIED WARRANTY OF MERCHANTABILITY, FITNESS FOR A PARTICULAR PURPOSE, OR NON-INFRINGEMENT. IN NO EVENT SHALL ATMEL BE LIABLE FOR ANY DIRECT, INDIRECT, CONSEQUENTIAL, PUNITIVE, SPECIAL OR INCIDENTAL DAMAGES (INCLUDING, WITHOUT LIMITATION, DAMAGES FOR LOSS AND PROFITS, BUSINESS INTERRUPTION, OR LOSS OF INFORMATION) ARISING OUT OF THE USE OR INABILITY TO USE THIS DOCUMENT, EVEN IF ATMEL HAS BEEN ADVISED OF THE POSSIBILITY OF SUCH DAMAGES. Atmel makes no representations or warranties with respect to the accuracy or completeness of the contents of this document and reserves the right to make changes to specifications and products descriptions at any time without notice. Atmel does not make any commitment to update the information contained herein. Unless specifically provided otherwise, Atmel products are not suitable for, and shall not be used in, automotive applications. Atmel products are not intended, authorized, or warranted for use as components in applications intended to support or sustain life.

## X-ON Electronics

Largest Supplier of Electrical and Electronic Components

*Click to view similar products for [Sockets & Adapters](#) category:*

*Click to view products by [Microchip](#) manufacturer:*

Other Similar products are found below :

[6508-0-00-01-00-00-33-0](#) [AC164341](#) [AC164348](#) [1262](#) [C8051F350-TB](#) [KITPF0100SKTEVBE](#) [LFVDBJR](#) [SK-AX2-CQ256-KITTOP](#)  
[AC164334](#) [AC164353](#) [AC164383](#) [SOCKET-ADM106XTQZ](#) [SPC564A80CAL176](#) [ST5M1267-001](#) [FP3-10PIN-ADAPTER-KIT](#) [CY3675-](#)  
[LCC4A](#) [TDGL015](#) [ATF15XXDK3-SAA100](#) [LFBGADATC](#) [SM64TQ-ACTEL-1](#) [SM68P-ACTEL](#) [8.06.03](#) [AC164358](#) [ATSTK600-RC99](#)  
[76002056](#) [DS91230+](#) [OM13019,598](#) [09185058](#) [AC164369](#) [AC164409](#) [AC164402](#) [SMPA-ISP-ACTEL-3-KIT](#) [ICESABCM81-01](#) [LFVDBGF](#)  
[AC164408](#) [KIT 70601-3](#) [S5U13U00P00C100](#) [AC164352](#) [PN-Q208/5256V](#) [PN-T100/LC4256](#) [LFBGAINTM55U1QA](#) [AC164370](#)  
[AC164355](#) [AC164367](#) [LFDAS12XEFT](#) [CY3675-TSSOP20B](#) [SPC563M64AVB144](#) [ATF15XXDK3-SAA44](#) [AC164410](#)  
[SPC563M64AVB176](#)