

HIGH-SIDE AND LOW-SIDE GATE DRIVER IN SO-14 (Type TH)

Description

The DGD21064 is a high voltage / high speed gate driver capable of driving N-Channel MOSFETs and IGBTs in a half bridge configuration. High voltage processing techniques enable the DGD21064's high-side to switch to 600V in a bootstrap operation.

The DGD21064 logic inputs are compatible with standard TTL and CMOS levels (down to 3.3V) to interface easily with controlling devices. The driver outputs feature high pulse current buffers designed for minimum driver cross conduction.

The DGD21064 is available in a 14-pin SO (Type TH) package and operates over an extended -40°C to +125°C temperature range.

Applications

- DC-DC Converters
- DC-AC Inverters
- AC-DC Power Supplies
- Motor Controls
- Class D Power Amplifiers

Features

- Floating High-Side Driver in Bootstrap Operation to 600V
- Drives Two N-Channel MOSFETs or IGBTs in Half Bridge Configuration
- Outputs Tolerant to Negative Transients
- Wide Logic and Low-Side Gate Driver Supply Voltage: 10V to 20V
- Wide Logic Supply Voltage Offset Voltage: -5V to 5V
- Logic Input (HIN and LIN) 3.3V Capability
- Schmitt Triggered Logic Inputs with Internal Pull Down
- Undervoltage Lockout for High and Low Side Drivers
- Extended Temperature Range: -40°C to +125°C
- **Totally Lead-Free & Fully RoHS Compliant (Notes 1 & 2)**
- **Halogen and Antimony Free. "Green" Device (Note 3)**

Mechanical Data

- Case: SO-14 (Type TH)
- Case Material: Molded Plastic, "Green" Molding Compound. UL Flammability Classification Rating 94V-0
- Moisture Sensitivity: Level 3 per J-STD-020
- Terminals: Finish – Matte Tin Plated Leads, Solderable per MIL-STD-202, Method 208 Ⓢ
- Weight: 0.142 grams (Approximate)

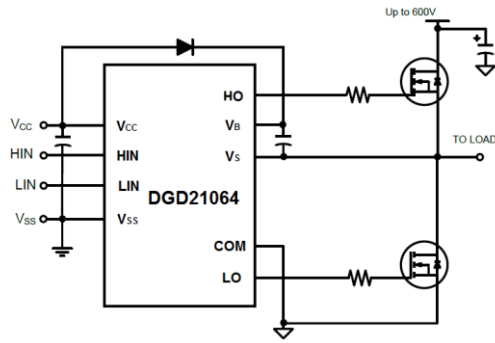

Typical Configuration



SO-14 (Type TH)
Top View

Ordering Information (Note 4)

Product	Marking	Reel Size (inches)	Tape Width (mm)	Quantity per Reel
DGD21064S14-13	DGD21064	13	16	2,500

- Notes:
1. No purposely added lead. Fully EU Directive 2002/95/EC (RoHS) & 2011/65/EU (RoHS 2) compliant.
 2. See http://www.diodes.com/quality/lead_free.html for more information about Diodes Incorporated's definitions of Halogen- and Antimony-free, "Green" and Lead-free.
 3. Halogen- and Antimony-free "Green" products are defined as those which contain <900ppm bromine, <900ppm chlorine (<1500ppm total Br + Cl) and <1000ppm antimony compounds.
 4. For packaging details, go to our website at <https://www.diodes.com/design/support/packaging/diodes-packaging/>.

Marking Information

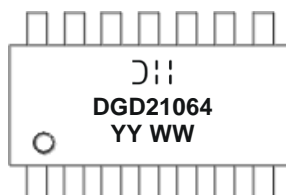

- ⌋⌋⌋ = Manufacturer's Marking
- DGD21064 = Product Type Marking Code
- YY = Year (ex: 17 = 2017)
- WW = Week (01 to 53)

Pin Diagrams

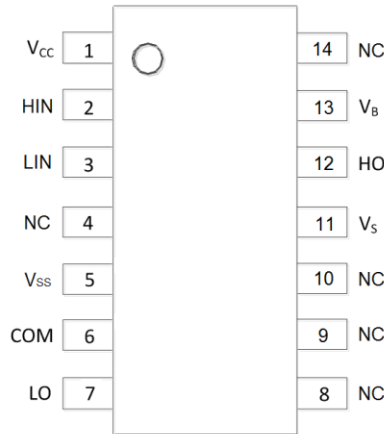

Top View: SO-14 (Type TH)

Pin Descriptions

Pin Number	Pin Name	Function
1	V _{CC}	Low-side and logic fixed supply
2	HIN	Logic input for high-side gate driver output, in phase with HO (Referenced to V _{SS})
3	LIN	Logic input for low-side gate driver output, in phase with LO (Referenced to V _{SS})
4,8,9,10,14	NC	No connect (No Internal Connection)
5	V _{SS}	Logic ground
6	COM	Low-side return
7	LO	Low-side gate drive output
11	V _S	High-side floating supply return
12	HO	High-side gate drive output
13	V _B	High-side floating supply

Functional Block Diagram

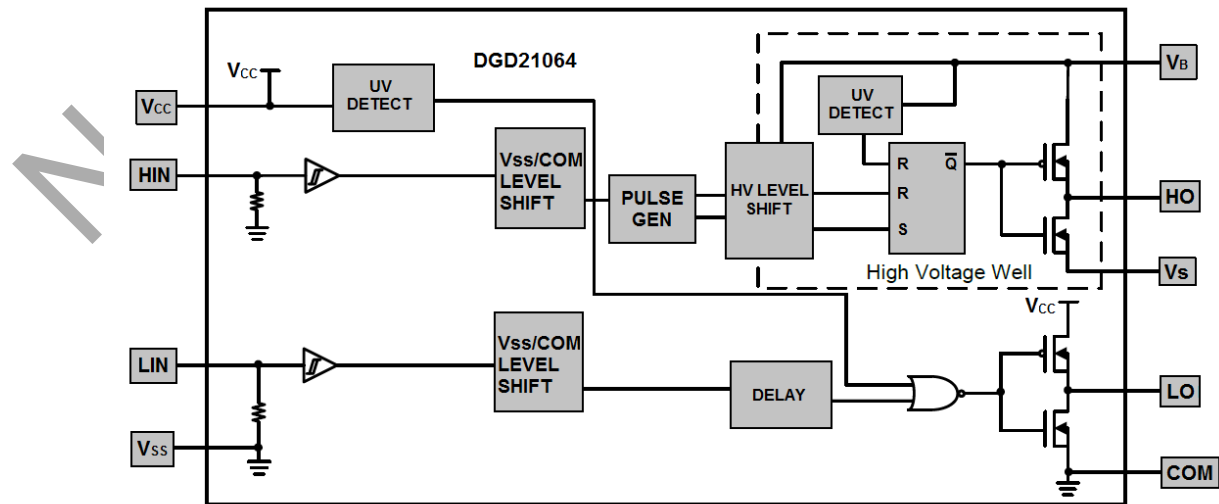

Absolute Maximum Ratings (@T_A = +25°C, unless otherwise specified.)

Characteristic	Symbol	Value	Unit
High-side Floating Supply Voltage	V _B	-0.3 to +624	V
High-side Floating Supply Offset Voltage	V _S	V _B -24 to V _B +0.3	V
High-side Floating Output Voltage	V _{HO}	V _S -0.3 to V _B +0.3	V
Offset Supply Voltage Transient	dV _S / dt	50	V/ns
Low-side and Logic Fixed Supply Voltage	V _{CC}	-0.3 to +24	V
Low-side Output Voltage	V _{LO}	-0.3 to V _{CC} +0.3	V
Logic Supply Offset Voltage	V _{SS}	V _{SS} -24 to V _{CC} +0.3	V
Logic Input Voltage (HIN and LIN)	V _{IN}	V _{SS} -0.3 to V _{CC} +0.3	V

Thermal Characteristics (@T_A = +25°C, unless otherwise specified.)

Characteristic	Symbol	Value	Unit
Power Dissipation Linear Derating Factor (Note 5)	P _D	1.0	W
Thermal Resistance, Junction to Ambient (Note 5)	R _{θJA}	120	°C/W
Operating Temperature	T _J	+150	°C
Lead Temperature (Soldering, 10s)	T _L	+300	
Storage Temperature Range	T _{STG}	-55 to +150	

Note: 5. When mounted on a standard JEDEC 2-layer FR-4 board.

Recommended Operating Conditions

Parameter	Symbol	Min	Max	Unit
High-side Floating Supply Absolute Voltage	V _B	V _S + 10	V _S + 20	V
High-side Floating Supply Offset Voltage	V _S	(Note 6)	600	V
High-side Floating Output Voltage	V _{HO}	V _S	V _B	V
Low-side Fixed Supply Voltage	V _{CC}	10	20	V
Low-side Output Voltage	V _{LO}	COM	V _{CC}	V
Logic Input Voltage (HIN and LIN)	V _{IN}	V _{SS}	5	V
Logic Ground	V _{SS}	-5	5	V
Ambient Temperature	T _A	-40	+125	°C

Note: 6. Logic operation for V_S of -5V to +600V. Logic state held for V_S of -5V to -V_{BS}.

DC Electrical Characteristics ($V_{BIAS} (V_{CC}, V_{BS}) = 15V, V_{SS} = COM, @T_A = +25^\circ C, \text{ unless otherwise specified.}$) (Note 7)

Parameter	Symbol	Min	Typ	Max	Unit	Condition
Logic "1" Input Voltage	V_{IH}	2.5	–	–	V	$V_{CC} = 10V \text{ to } 20V$
Logic "0" Input Voltage	V_{IL}	–	–	0.6	V	$V_{CC} = 10V \text{ to } 20V$
High Level Output Voltage, $V_{BIAS} - V_O$	V_{OH}	–	0.05	0.2	V	$I_O = 2mA$
Low Level Output Voltage, V_O	V_{OL}	–	0.02	0.1	V	$I_O = 2mA$
Offset Supply Leakage Current	I_{LK}	–	–	50	μA	$V_B = V_S = 600V$
Quiescent V_{BS} Supply Current	I_{BSQ}	20	75	130	μA	$V_{IN} = 0V \text{ or } 5V$
Quiescent V_{CC} Supply Current	I_{CCQ}	60	120	180	μA	$V_{IN} = 0V \text{ or } 5V$
Logic "1" Input Bias Current	I_{IN+}	–	5.0	20	μA	$V_{IN} = 5V$
Logic "0" Input Bias Current	I_{IN-}	–	–	5.0	μA	$V_{IN} = 0V$
V_{BS} Supply Under-voltage Positive Going Threshold	V_{BSUV+}	8.0	8.9	9.8	V	–
V_{BS} Supply Under-voltage Negative Going Threshold	V_{BSUV-}	7.4	8.2	9.0	V	–
V_{CC} Supply Under-voltage Positive Going Threshold	V_{CCUV+}	8.0	8.9	9.8	V	–
V_{CC} Supply Under-voltage Negative Going Threshold	V_{CCUV-}	7.4	8.2	9.0	V	–
Hysteresis	V_{CCUVH}	0.3	0.7	–	V	–
	V_{BSUVH}	0.3	0.7	–	V	–
Output High Short Circuit Pulsed Current	I_{O+}	130	290	–	mA	$V_O = 0V, PW \leq 10\mu s$
Output Low Short Circuit Pulsed Current	I_{O-}	270	600	–	mA	$V_O = 15V, PW \leq 10\mu s$

Note: 7. The V_{IN} and I_{IN} parameters are referenced to COM and are applicable to the two logic pins: HIN and LIN. The V_O and I_O parameters are referenced to COM and are applicable to the respective output pins: HO and LO.

AC Electrical Characteristics ($V_{BIAS} (V_{CC}, V_{BS}) = 15V, C_L = 1000pF, V_{SS} = COM, @T_A = +25^\circ C, \text{ unless otherwise specified.}$)

Parameter	Symbol	Min	Typ	Max	Unit	Condition
Turn-on Propagation Delay	t_{ON}	–	220	300	ns	$V_S = 0V$
Turn-off Propagation Delay	t_{OFF}	–	200	280	ns	$V_S = 0V \text{ or } 600V$
Delay Matching	t_{DM}	–	–	30	ns	–
Turn-on Rise Time	t_R	–	100	220	ns	$V_S = 0V$
Turn-off Fall Time	t_F	–	35	80	ns	$V_S = 0V$

Timing Waveforms

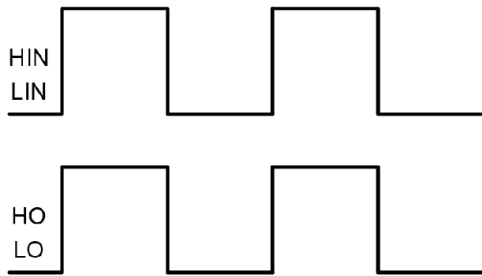

Figure 1. Input / Output Timing Diagram

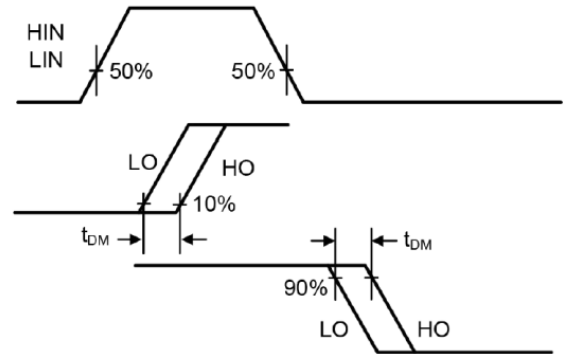

Figure 2. Delay Matching Waveform Definitions

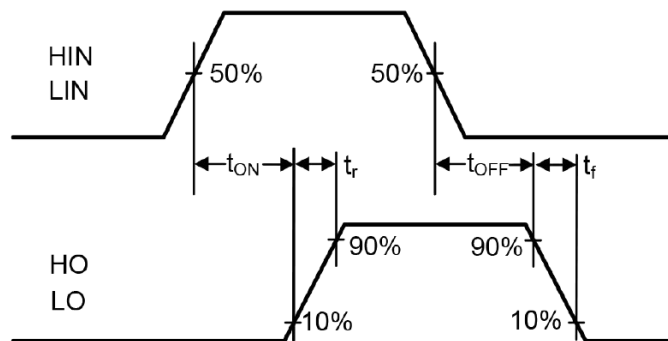

Figure 3. Switching Time Waveform Definitions

NOT FOR

FORM

Typical Performance Characteristics (@T_A = +25°C, unless otherwise specified.)

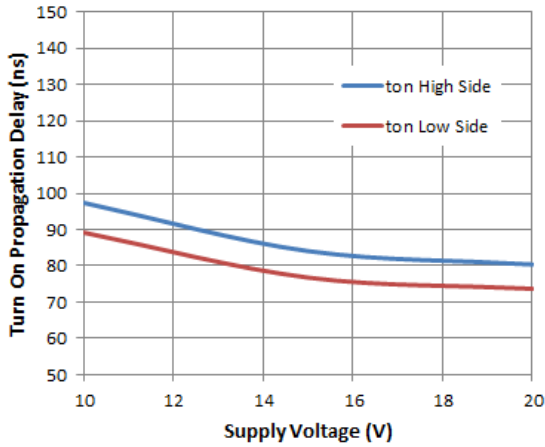

Figure 4. Turn-on Propagation Delay vs. Supply Voltage

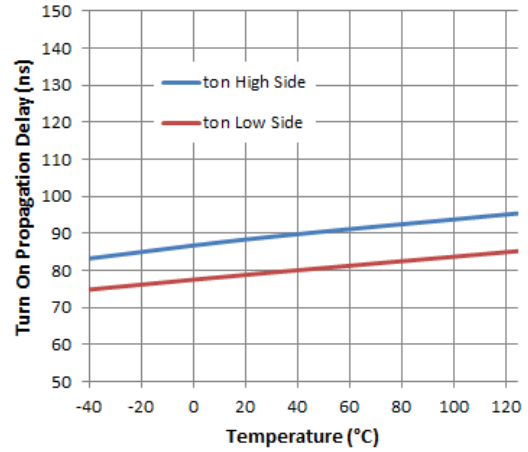

Figure 5. Turn-on Propagation Delay vs. Temperature

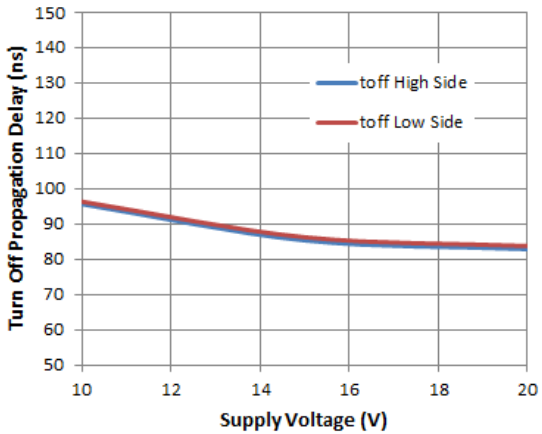

Figure 6. Turn-off Propagation Delay vs. Supply Voltage

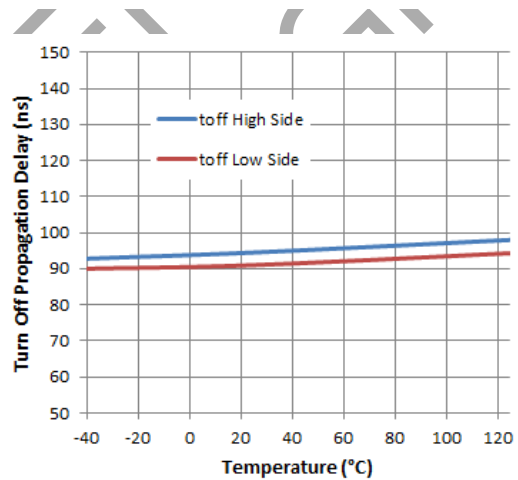

Figure 7. Turn-off Propagation Delay vs. Temperature

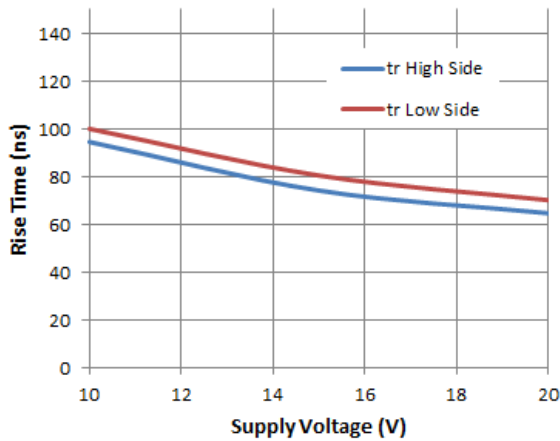

Figure 8. Rise Time vs. Supply Voltage

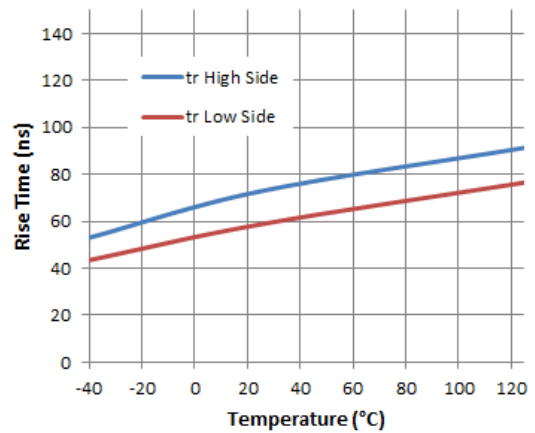

Figure 9. Rise Time vs. Temperature

Typical Performance Characteristics (Cont.)

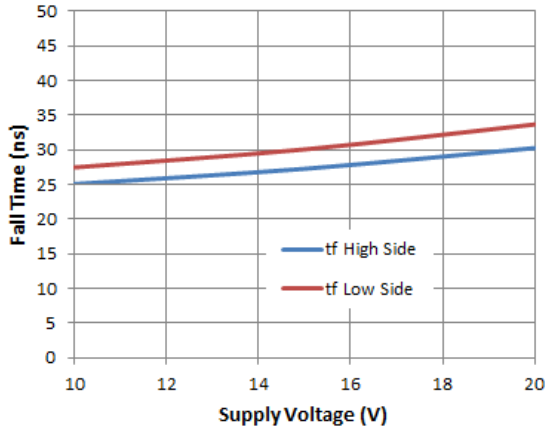

Figure 10. Fall Time vs. Supply Voltage

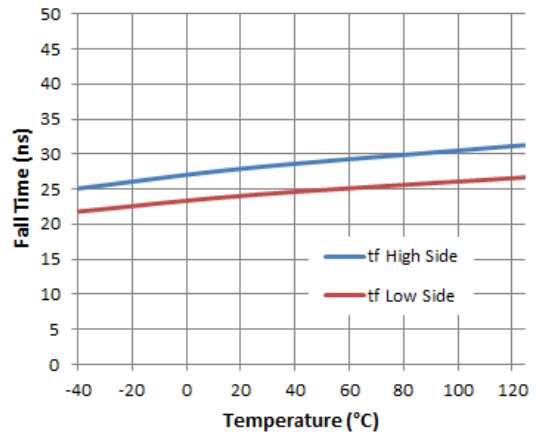

Figure 11. Fall Time vs. Temperature

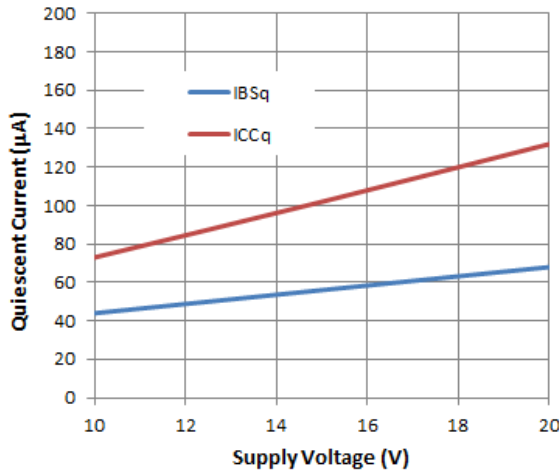

Figure 12. Quiescent Current vs. Supply Voltage

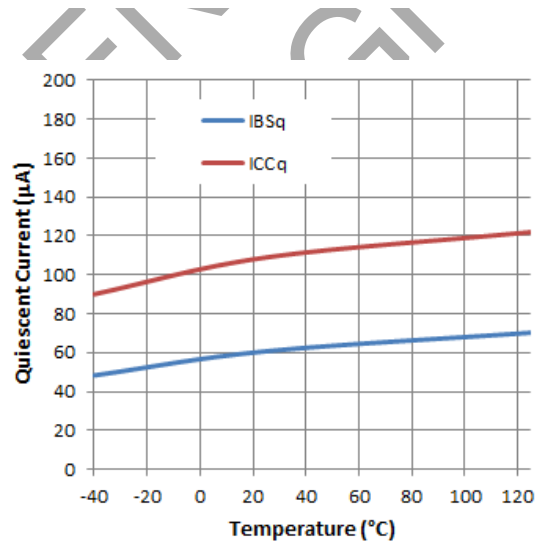

Figure 13. Quiescent Current vs. Temperature

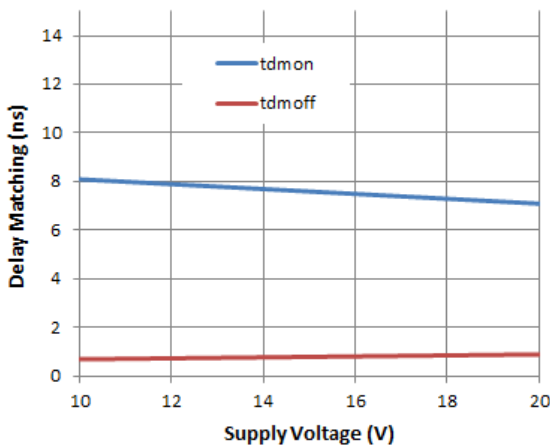

Figure 14. Delay Matching vs. Supply Voltage

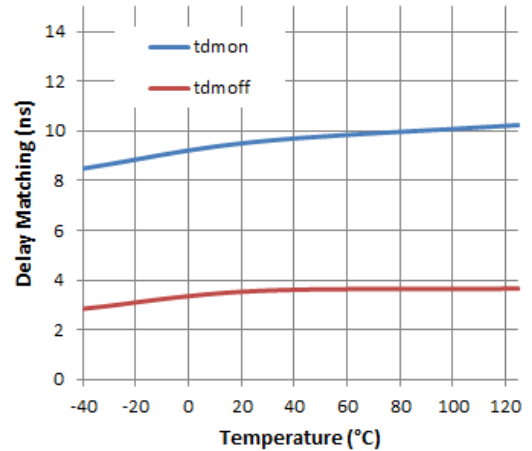

Figure 15. Delay Matching vs. Temperature

Typical Performance Characteristics (Cont.)

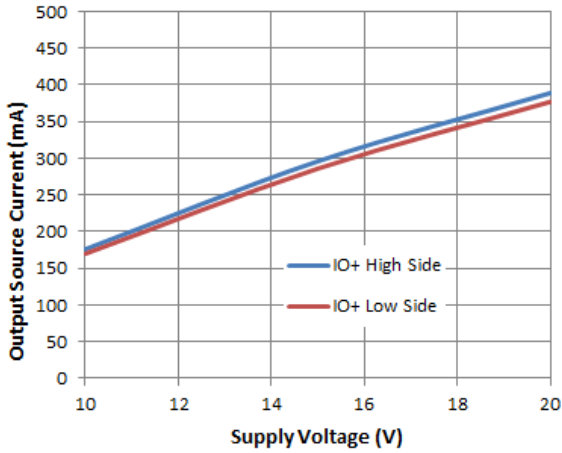

Figure 16. Output Source Current vs. Supply Voltage

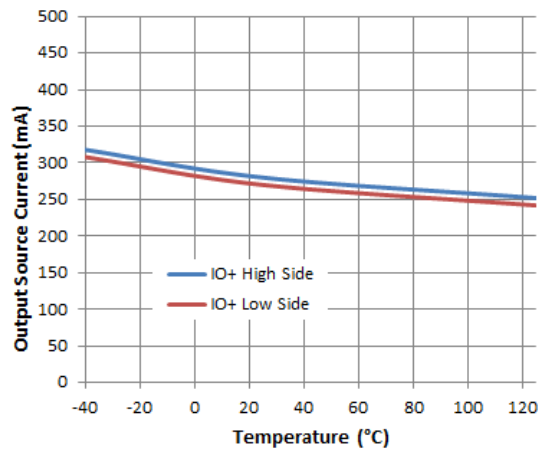

Figure 17. Output Source Current vs. Temperature

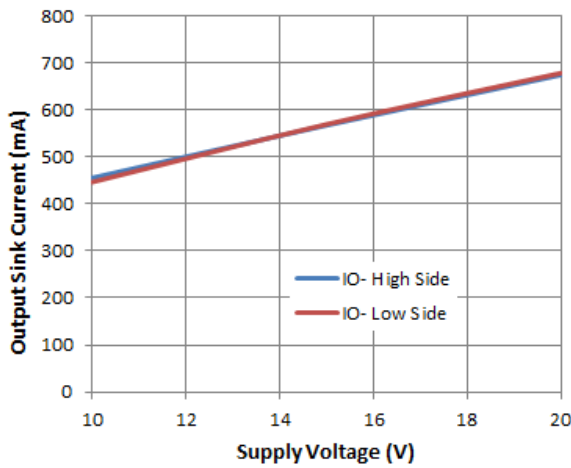

Figure 18. Output Sink Current vs. Supply Voltage

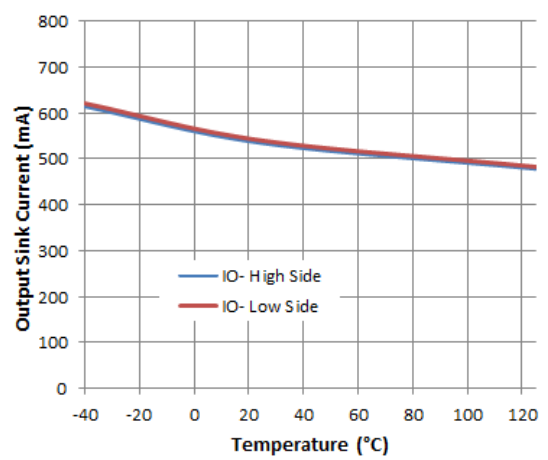

Figure 19. Output Sink Current vs. Temperature

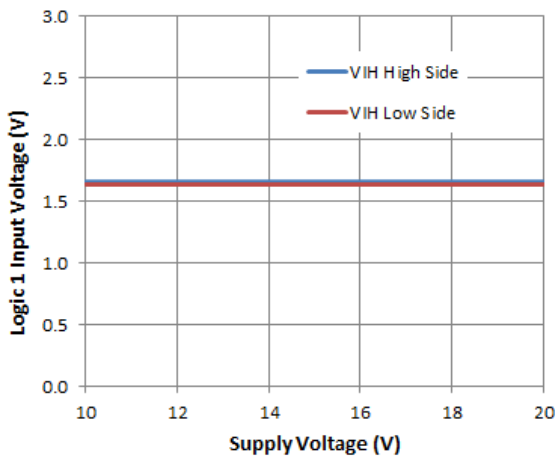

Figure 20. Logic 1 Input Voltage vs. Supply Voltage

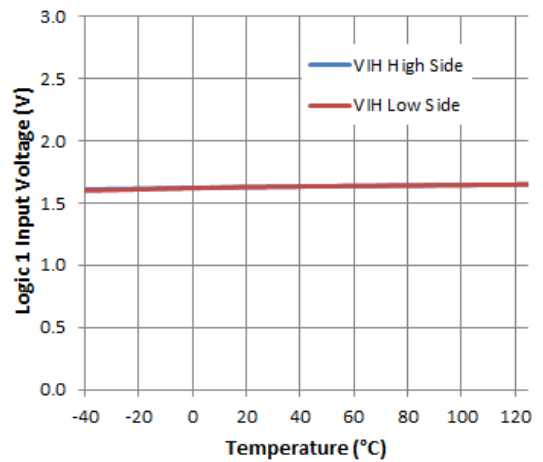

Figure 21. Logic 1 Input Voltage vs. Temperature

Typical Performance Characteristics (Cont.)

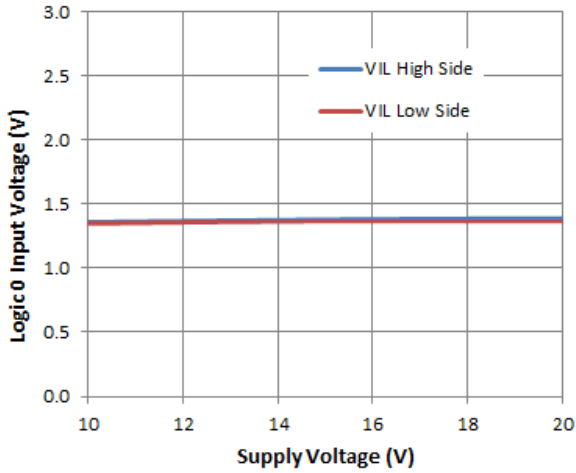

Figure 22. Logic 0 Input Voltage vs. Supply Voltage

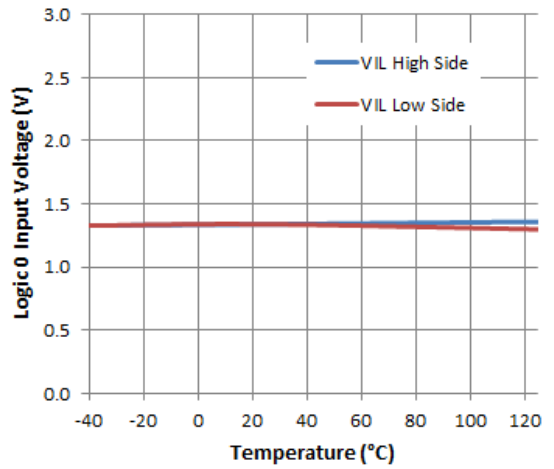

Figure 23. Logic 0 Input Voltage vs. Temperature

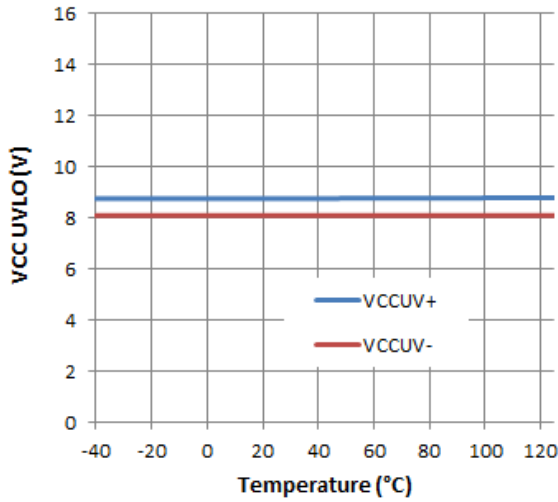

Figure 24. VCC UVLO vs. Temperature

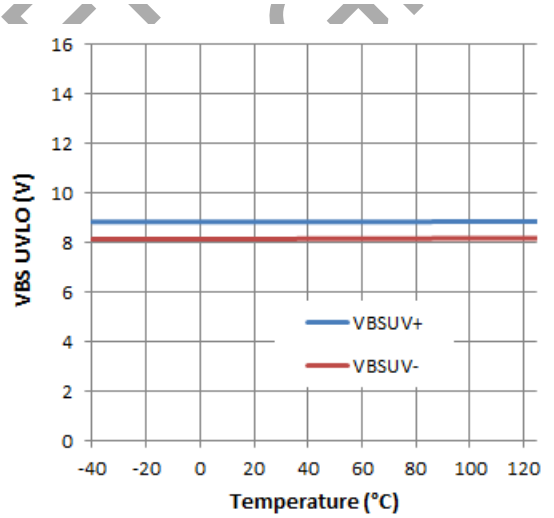

Figure 25. VBS UVLO vs. Temperature

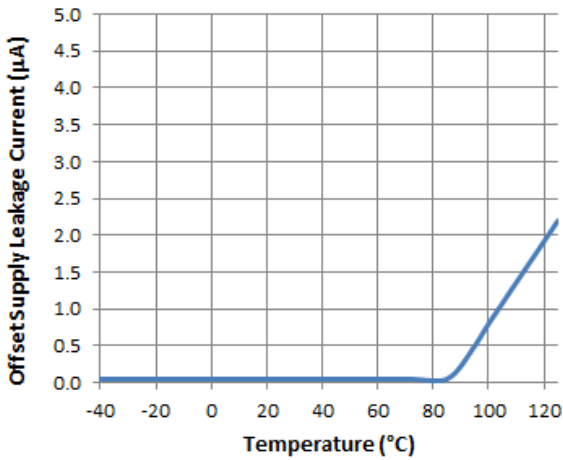
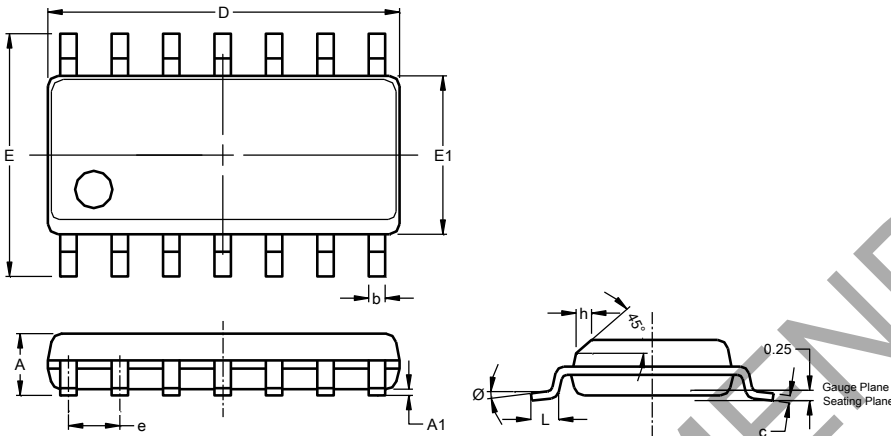

Figure 26. Offset Supply Leakage Current vs. Temperature

Package Outline Dimensions

Please see <http://www.diodes.com/package-outlines.html> for the latest version.

SO-14 (Type TH)



SO-14 (Type TH)			
Dim	Min	Max	Typ
A	1.55	1.73	--
A1	0.10	0.25	--
b	0.35	0.51	--
c	0.190	0.248	--
D	8.56	8.74	8.61
E	5.84	6.20	6.00
E1	3.81	3.99	3.94
e	--	--	1.27
h	--	--	0.33
L	0.41	0.89	--
Ø	0°	8°	--
All Dimensions in mm			

Suggested Pad Layout

Please see <http://www.diodes.com/package-outlines.html> for the latest version.

SO-14 (Type TH)

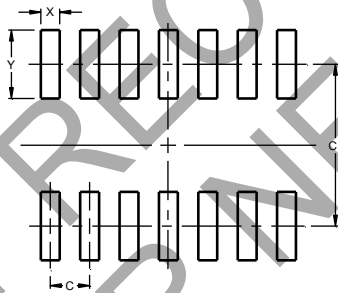

Dimensions	Value (in mm)
C	1.27
C1	5.20
X	0.60
Y	2.20

Note: For high voltage applications, the appropriate industry sector guidelines should be considered with regards to creepage and clearance distances between device Terminals and PCB tracking.

IMPORTANT NOTICE

DIODES INCORPORATED MAKES NO WARRANTY OF ANY KIND, EXPRESS OR IMPLIED, WITH REGARDS TO THIS DOCUMENT, INCLUDING, BUT NOT LIMITED TO, THE IMPLIED WARRANTIES OF MERCHANTABILITY AND FITNESS FOR A PARTICULAR PURPOSE (AND THEIR EQUIVALENTS UNDER THE LAWS OF ANY JURISDICTION).

Diodes Incorporated and its subsidiaries reserve the right to make modifications, enhancements, improvements, corrections or other changes without further notice to this document and any product described herein. Diodes Incorporated does not assume any liability arising out of the application or use of this document or any product described herein; neither does Diodes Incorporated convey any license under its patent or trademark rights, nor the rights of others. Any Customer or user of this document or products described herein in such applications shall assume all risks of such use and will agree to hold Diodes Incorporated and all the companies whose products are represented on Diodes Incorporated website, harmless against all damages.

Diodes Incorporated does not warrant or accept any liability whatsoever in respect of any products purchased through unauthorized sales channel. Should Customers purchase or use Diodes Incorporated products for any unintended or unauthorized application, Customers shall indemnify and hold Diodes Incorporated and its representatives harmless against all claims, damages, expenses, and attorney fees arising out of, directly or indirectly, any claim of personal injury or death associated with such unintended or unauthorized application.

Products described herein may be covered by one or more United States, international or foreign patents pending. Product names and markings noted herein may also be covered by one or more United States, international or foreign trademarks.

This document is written in English but may be translated into multiple languages for reference. Only the English version of this document is the final and determinative format released by Diodes Incorporated.

LIFE SUPPORT

Diodes Incorporated products are specifically not authorized for use as critical components in life support devices or systems without the express written approval of the Chief Executive Officer of Diodes Incorporated. As used herein:

A. Life support devices or systems are devices or systems which:

1. are intended to implant into the body, or
2. support or sustain life and whose failure to perform when properly used in accordance with instructions for use provided in the labeling can be reasonably expected to result in significant injury to the user.

B. A critical component is any component in a life support device or system whose failure to perform can be reasonably expected to cause the failure of the life support device or to affect its safety or effectiveness.

Customers represent that they have all necessary expertise in the safety and regulatory ramifications of their life support devices or systems, and acknowledge and agree that they are solely responsible for all legal, regulatory and safety-related requirements concerning their products and any use of Diodes Incorporated products in such safety-critical, life support devices or systems, notwithstanding any devices- or systems-related information or support that may be provided by Diodes Incorporated. Further, Customers must fully indemnify Diodes Incorporated and its representatives against any damages arising out of the use of Diodes Incorporated products in such safety-critical, life support devices or systems.

Copyright © 2017, Diodes Incorporated

www.diodes.com

X-ON Electronics

Largest Supplier of Electrical and Electronic Components

Click to view similar products for [Gate Drivers](#) category:

Click to view products by [Diodes Incorporated](#) manufacturer:

Other Similar products are found below :

[00028](#) [00053P0231](#) [8967380000](#) [56956](#) [CR7E-30DB-3.96E\(72\)](#) [57.404.7355.5](#) [LT4936](#) [57.904.0755.0](#) [5801-0903](#) [5803-0901](#) [5811-0902](#)
[5813-0901](#) [58410](#) [00576P0030](#) [00581P0070](#) [5882900001](#) [00103P0020](#) [00600P0005](#) [00-9050-LRPP](#) [00-9090-RDPP](#) [5951900000](#) [01-](#)
[1003W-10/32-15](#) [LTI LA6E-1S-WH-RC-FN12VXCR1](#) [0131700000](#) [00-2240](#) [LTP70N06](#) [LVP640](#) [0158-624-00](#) [5J0-1000LG-SIL](#) [020017-13](#)
[LY1D-2-5S-AC120](#) [LY2-0-US-AC120](#) [LY2-US-AC240](#) [LY3-UA-DC24](#) [00-5150](#) [00576P0020](#) [00600P0010](#) [LZNQ2M-US-DC5](#) [LZNQ2-](#)
[US-DC12](#) [LZP40N10](#) [00-8196-RDPP](#) [00-8274-RDPP](#) [00-8275-RDNP](#) [00-8609-RDPP](#) [00-8722-RDPP](#) [00-8728-WHPP](#) [00-8869-RDPP](#) [00-](#)
[9051-RDPP](#) [00-9091-LRPP](#) [00-9291-RDPP](#)