

IRG4IBC20FDPbF

INSULATED GATE BIPOLAR TRANSISTOR WITH
ULTRAFAST SOFT RECOVERY DIODE

Fast CoPack IGBT

Features

- Very Low 1.66V voltage drop
- 2.5kV, 60s insulation voltage ⑤
- 4.8 mm creepage distance to heatsink
- Fast: Optimized for medium operating frequencies (1-5 kHz in hard switching, >20 kHz in resonant mode).
- IGBT co-packaged with HEXFRED™ ultrafast, ultrasoft recovery antiparallel diodes
- Tighter parameter distribution
- Industry standard Isolated TO-220 Fullpak™ outline
- Lead-Free

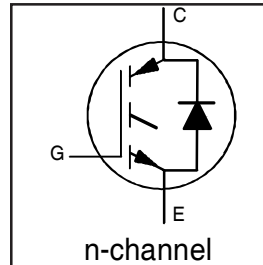

$V_{CES} = 600V$
$V_{CE(on) typ.} = 1.66V$
@ $V_{GE} = 15V, I_C = 9.0A$

Benefits

- Simplified assembly
- Highest efficiency and power density
- HEXFRED™ antiparallel Diode minimizes switching losses and EMI

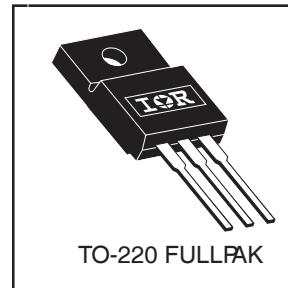

Absolute Maximum Ratings

	Parameter	Max.	Units
V_{CES}	Collector-to-Emitter Voltage	600	V
$I_C @ T_C = 25^\circ C$	Continuous Collector Current	14.3	A
$I_C @ T_C = 100^\circ C$	Continuous Collector Current	7.7	
I_{CM}	Pulsed Collector Current ①	64	
I_{LM}	Clamped Inductive Load Current ②	64	
$I_F @ T_C = 100^\circ C$	Diode Continuous Forward Current	6.5	
I_{FM}	Diode Maximum Forward Current	64	
Visol	RMS Isolation Voltage, Terminal to Case③	2500	V
V_{GE}	Gate-to-Emitter Voltage	± 20	
$P_D @ T_C = 25^\circ C$	Maximum Power Dissipation	34	W
$P_D @ T_C = 100^\circ C$	Maximum Power Dissipation	14	
T_J	Operating Junction and	-55 to +150	°C
T_{STG}	Storage Temperature Range		
	Soldering Temperature, for 10 sec.	300 (0.063 in. (1.6mm) from case)	
	Mounting Torque, 6-32 or M3 Screw.	10 lbf•in (1.1 N•m)	

Thermal Resistance

	Parameter	Typ.	Max.	Units
$R_{\theta JC}$	Junction-to-Case - IGBT	—	3.7	°C/W
$R_{\theta JC}$	Junction-to-Case - Diode	—	5.1	
$R_{\theta JA}$	Junction-to-Ambient, typical socket mount	—	65	
Wt	Weight	2.0 (0.07)	—	g (oz)

IRG4IBC20FDPbF

Electrical Characteristics @ T_J = 25°C (unless otherwise specified)

	Parameter	Min.	Typ.	Max.	Units	Conditions
V _{(BR)CES}	Collector-to-Emitter Breakdown Voltage ^③	600	—	—	V	V _{GE} = 0V, I _C = 250μA
ΔV _{(BR)CES} /ΔT _J	Temperature Coeff. of Breakdown Voltage	—	0.72	—	V/°C	V _{GE} = 0V, I _C = 1.0mA
V _{CE(on)}	Collector-to-Emitter Saturation Voltage	—	1.66	2.0	V	I _C = 9.0A
		—	2.06	—		I _C = 16A
		—	1.76	—		I _C = 9.0A, T _J = 150°C
V _{GE(th)}	Gate Threshold Voltage	3.0	—	6.0		V _{CE} = V _{GE} , I _C = 250μA
ΔV _{GE(th)} /ΔT _J	Temperature Coeff. of Threshold Voltage	—	-11	—	mV/°C	V _{CE} = V _{GE} , I _C = 250μA
g _{fe}	Forward Transconductance ^④	2.9	5.1	—	S	V _{CE} = 100V, I _C = 9.0A
I _{CES}	Zero Gate Voltage Collector Current	—	—	250	μA	V _{GE} = 0V, V _{CE} = 600V
		—	—	1700		V _{GE} = 0V, V _{CE} = 600V, T _J = 150°C
V _{FM}	Diode Forward Voltage Drop	—	1.4	1.7	V	I _C = 8.0A
		—	1.3	1.6		I _C = 8.0A, T _J = 150°C
I _{GES}	Gate-to-Emitter Leakage Current	—	—	±100	nA	V _{GE} = ±20V

Switching Characteristics @ T_J = 25°C (unless otherwise specified)

	Parameter	Min.	Typ.	Max.	Units	Conditions
Q _g	Total Gate Charge (turn-on)	—	27	40	nC	I _C = 9.0A
Q _{ge}	Gate - Emitter Charge (turn-on)	—	4.2	6.2		V _{CC} = 400V
Q _{gc}	Gate - Collector Charge (turn-on)	—	9.9	15		V _{GE} = 15V
t _{d(on)}	Turn-On Delay Time	—	43	—	ns	T _J = 25°C
t _r	Rise Time	—	20	—		I _C = 9.0A, V _{CC} = 480V
t _{d(off)}	Turn-Off Delay Time	—	240	360		V _{GE} = 15V, R _G = 50Ω
t _f	Fall Time	—	150	220		Energy losses include "tail" and diode reverse recovery.
E _{on}	Turn-On Switching Loss	—	0.25	—	mJ	See Fig. 9, 10, 18
E _{off}	Turn-Off Switching Loss	—	0.64	—		
E _{ts}	Total Switching Loss	—	0.89	1.3		
t _{d(on)}	Turn-On Delay Time	—	41	—	ns	T _J = 150°C, See Fig. 11, 18
t _r	Rise Time	—	22	—		I _C = 9.0A, V _{CC} = 480V
t _{d(off)}	Turn-Off Delay Time	—	320	—		V _{GE} = 15V, R _G = 50Ω
t _f	Fall Time	—	290	—		Energy losses include "tail" and diode reverse recovery.
E _{ts}	Total Switching Loss	—	1.35	—	mJ	
L _E	Internal Emitter Inductance	—	7.5	—	nH	Measured 5mm from package
C _{ies}	Input Capacitance	—	540	—	pF	V _{GE} = 0V
C _{oes}	Output Capacitance	—	37	—		V _{CC} = 30V
C _{res}	Reverse Transfer Capacitance	—	7.0	—		f = 1.0MHz
t _{rr}	Diode Reverse Recovery Time	—	37	55	ns	T _J = 25°C See Fig. 14
		—	55	90		T _J = 125°C
I _{rr}	Diode Peak Reverse Recovery Current	—	3.5	5.0	A	T _J = 25°C See Fig. 15
		—	4.5	8.0		T _J = 125°C
Q _{rr}	Diode Reverse Recovery Charge	—	65	138	nC	T _J = 25°C See Fig. 16
		—	124	360		T _J = 125°C
di _(rec) M/dt	Diode Peak Rate of Fall of Recovery During t _b	—	240	—	A/μs	T _J = 25°C See Fig. 17
		—	210	—		T _J = 125°C

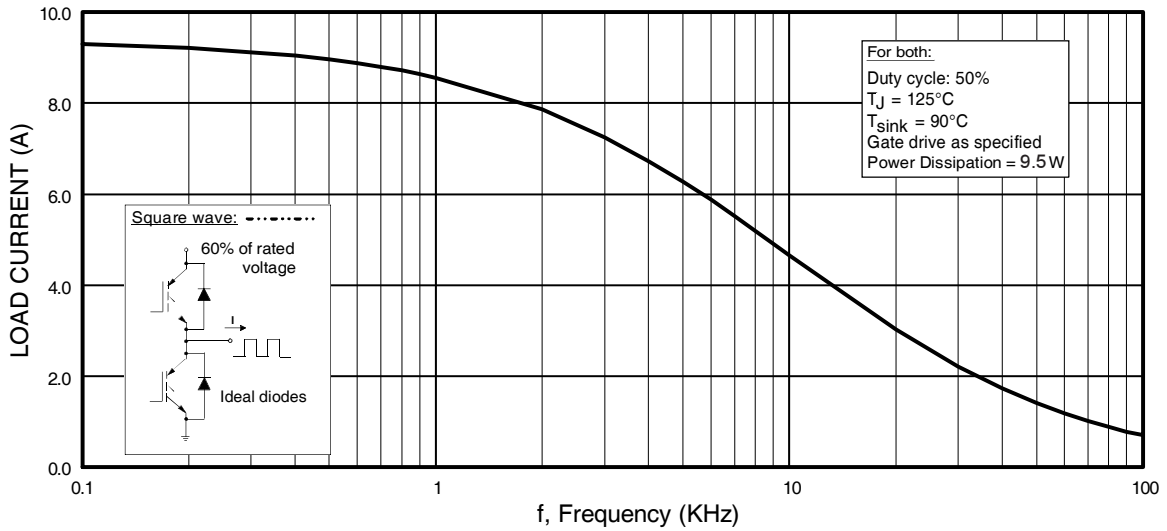

Fig. 1 - Typical Load Current vs. Frequency
 (Load Current = I_{RMS} of fundamental)

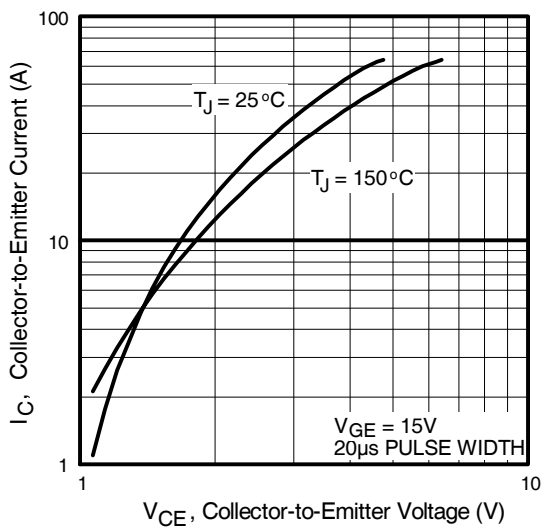

Fig. 2 - Typical Output Characteristics
www.irf.com

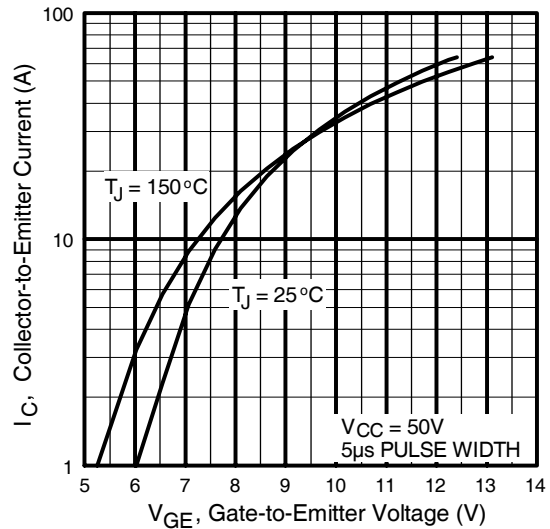

Fig. 3 - Typical Transfer Characteristics

IRG4IBC20FDPbF

International
IRF Rectifier

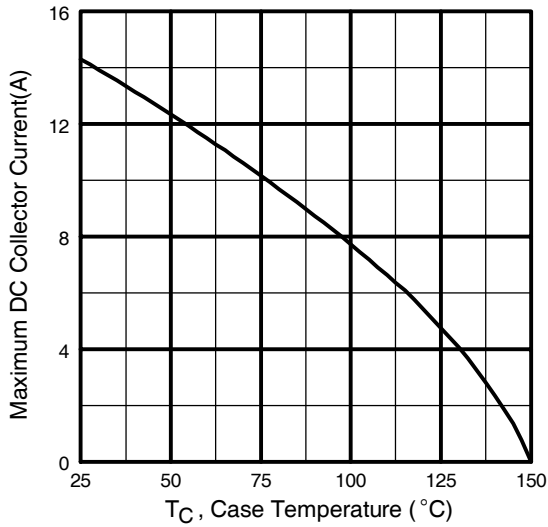

Fig. 4 - Maximum Collector Current vs. Case Temperature

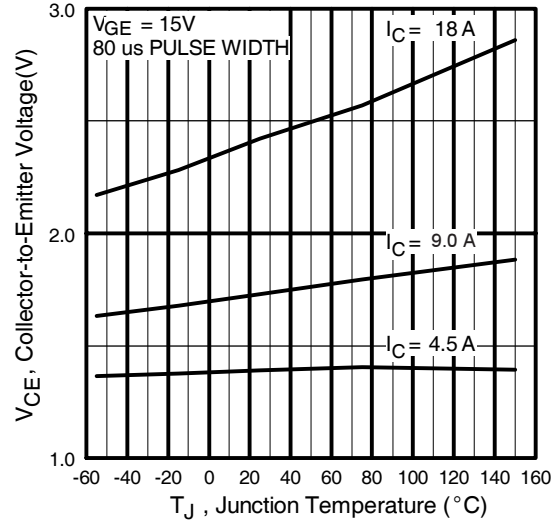

Fig. 5 - Typical Collector-to-Emitter Voltage vs. Junction Temperature

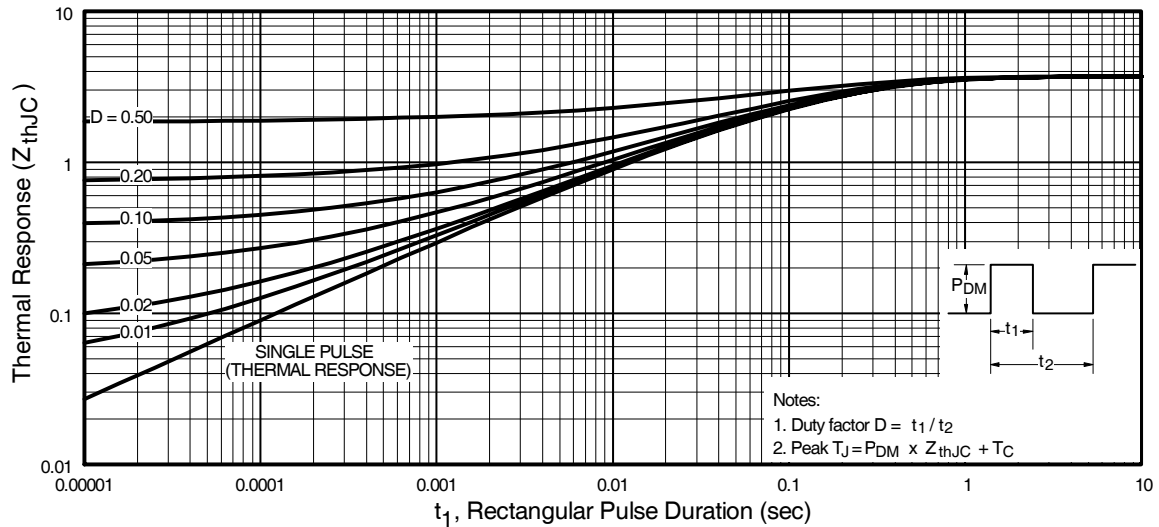

Fig. 6 - Maximum Effective Transient Thermal Impedance, Junction-to-Case

IRG4IBC20FDPbF

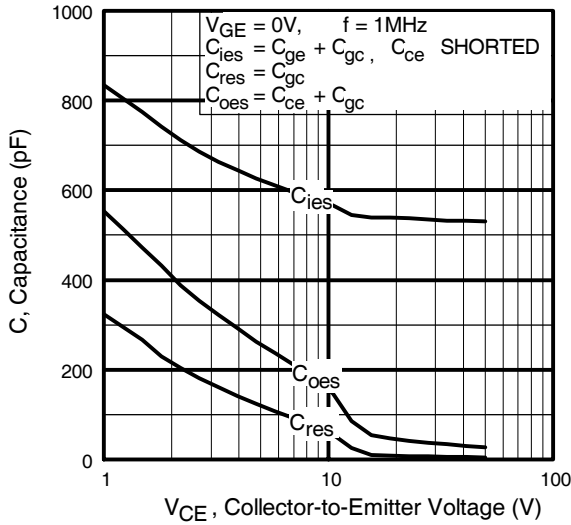

Fig. 7 - Typical Capacitance vs. Collector-to-Emitter Voltage

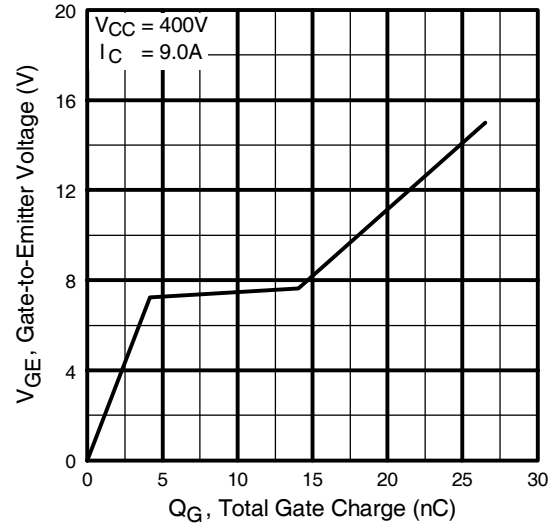

Fig. 8 - Typical Gate Charge vs. Gate-to-Emitter Voltage

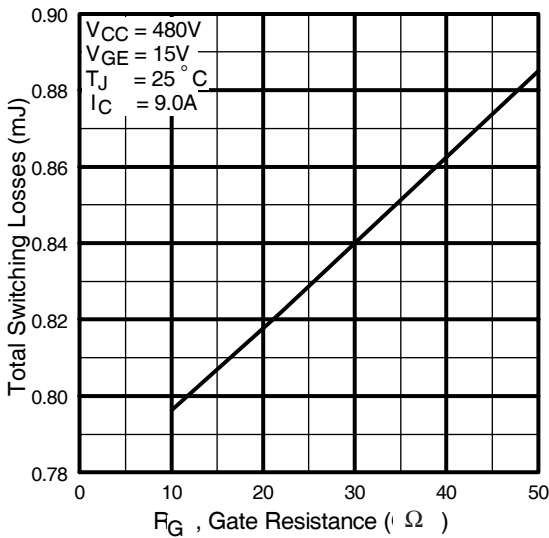

Fig. 9 - Typical Switching Losses vs. Gate Resistance

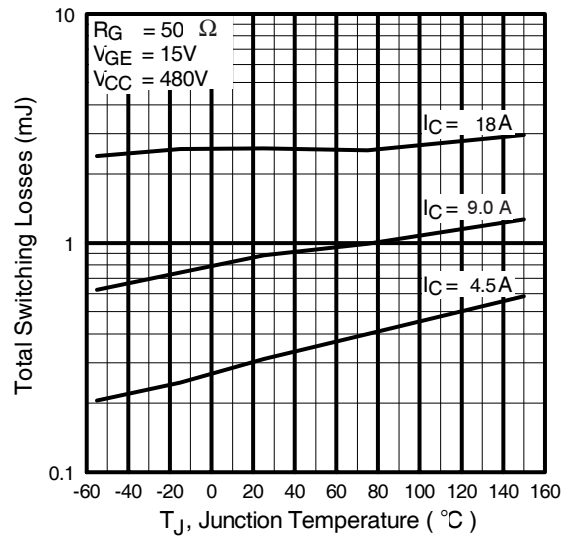

Fig. 10 - Typical Switching Losses vs. Junction Temperature

IRG4IBC20FDPbF

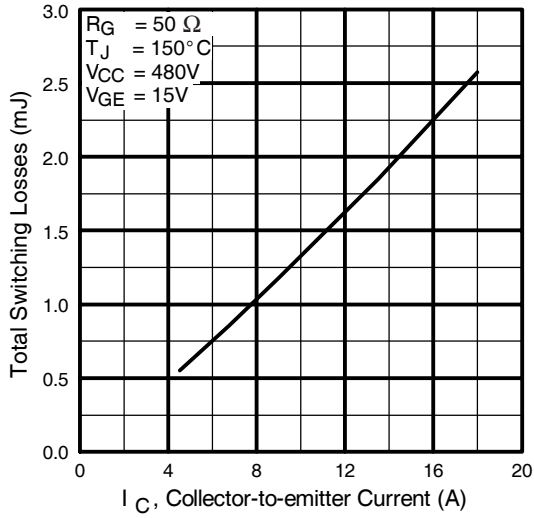

Fig. 11 - Typical Switching Losses vs. Collector-to-Emitter Current

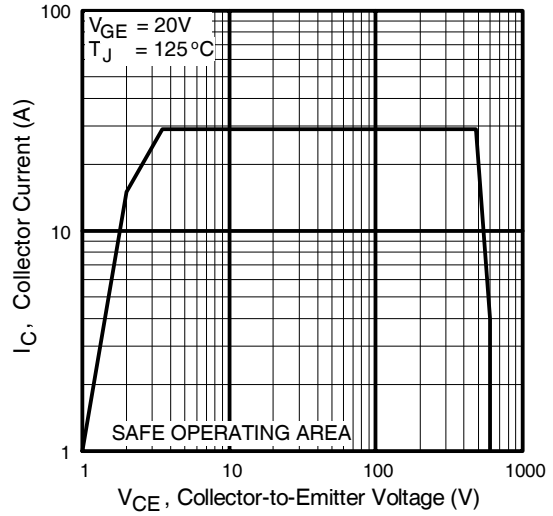

Fig. 12 - Turn-Off SOA

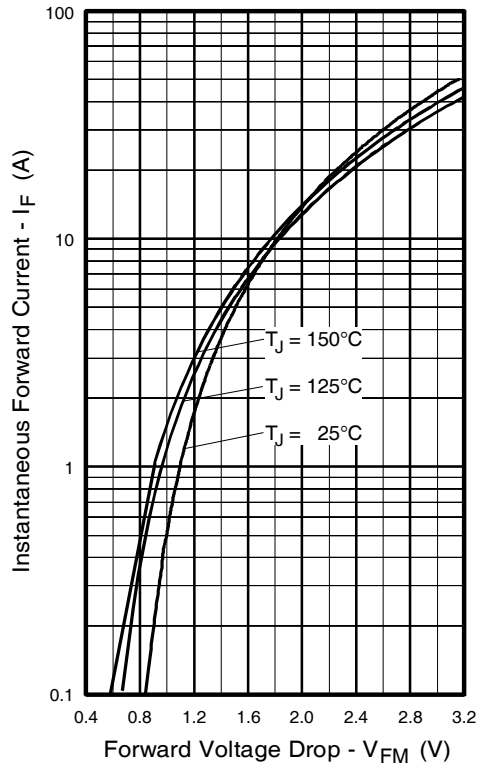

Fig. 13 - Maximum Forward Voltage Drop vs. Instantaneous Forward Current

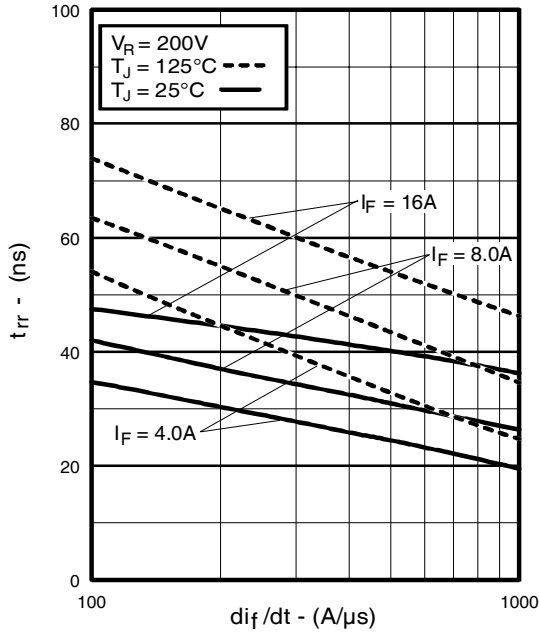

Fig. 14 - Typical Reverse Recovery vs. di_f/dt

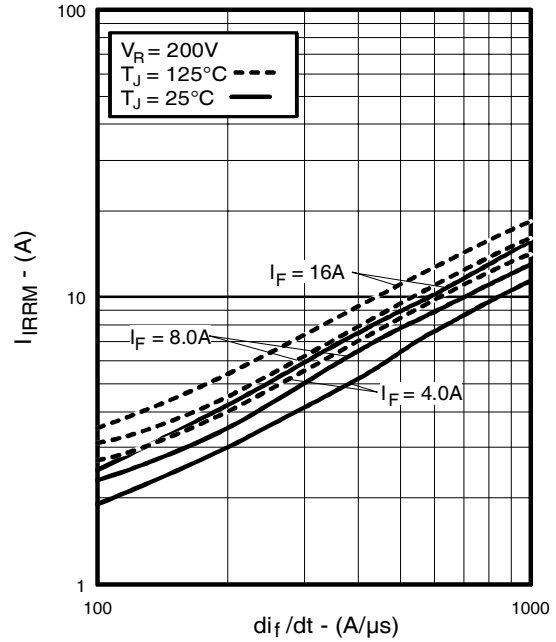

Fig. 15 - Typical Recovery Current vs. di_f/dt

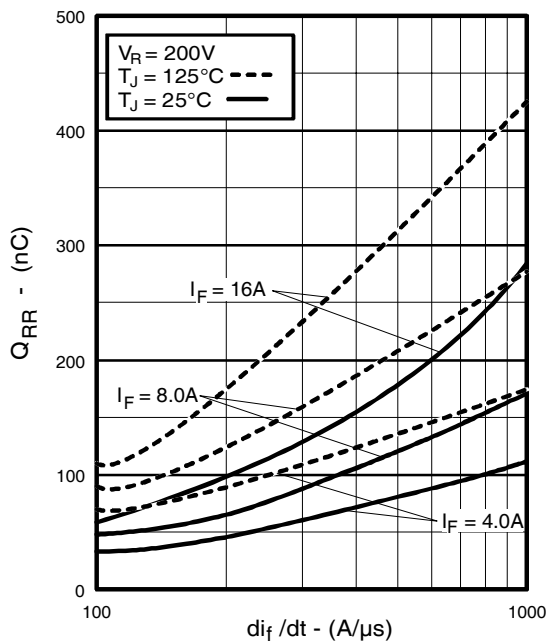

Fig. 16 - Typical Stored Charge vs. di_f/dt
www.irf.com

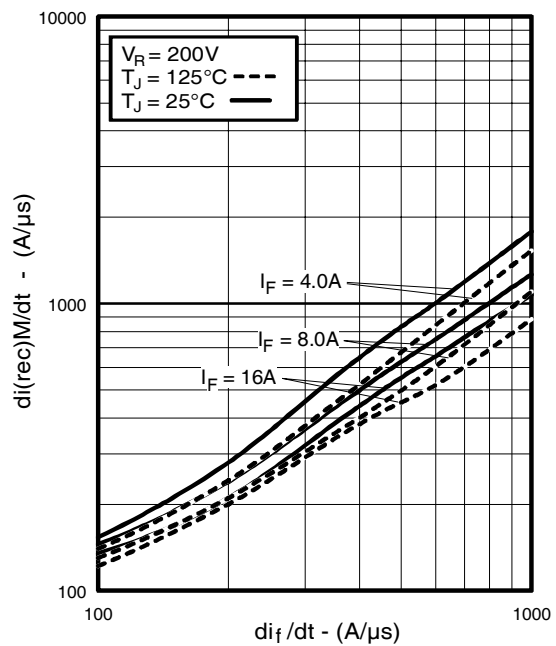

Fig. 17 - Typical $di_{(rec)M}/dt$ vs. di_f/dt

IRG4IBC20FDPbF

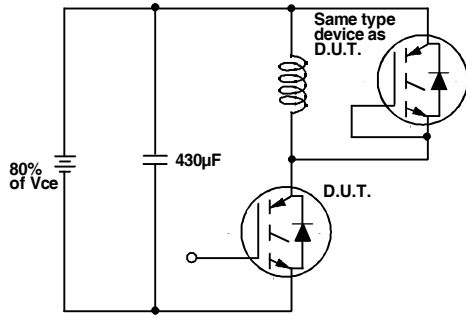

Fig. 18a - Test Circuit for Measurement of I_{LM} , E_{on} , $E_{off}(\text{diode})$, t_{rr} , Q_{rr} , I_{rr} , $t_{d(on)}$, t_r , $t_{d(off)}$, t_f

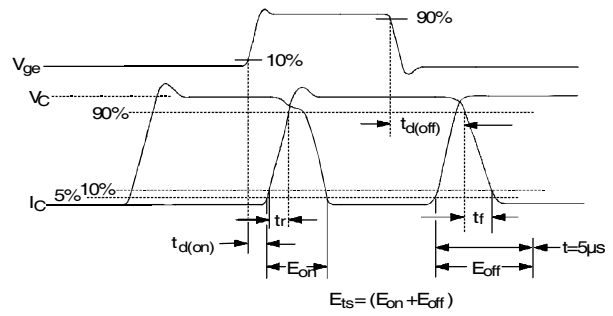

Fig. 18b - Test Waveforms for Circuit of Fig. 18a, Defining E_{off} , $t_{d(off)}$, t_f

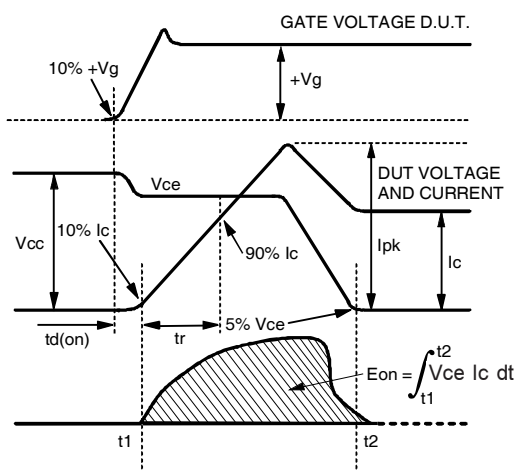

Fig. 18c - Test Waveforms for Circuit of Fig. 18a, Defining E_{on} , $t_{d(on)}$, t_r

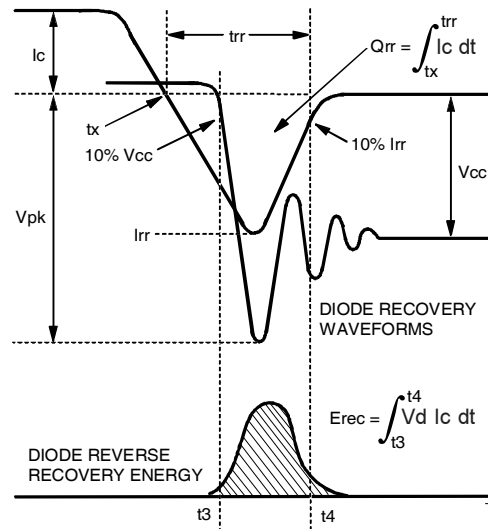

Fig. 18d - Test Waveforms for Circuit of Fig. 18a, Defining E_{rec} , t_{rr} , Q_{rr} , I_{rr}

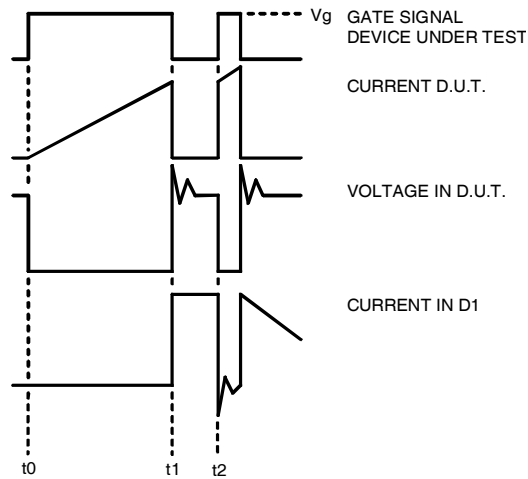

Figure 18e. Macro Waveforms for Figure 18a's Test Circuit

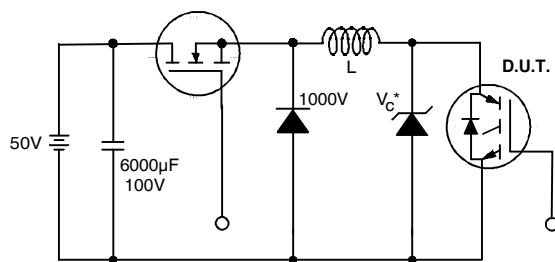

Figure 19. Clamped Inductive Load Test Circuit

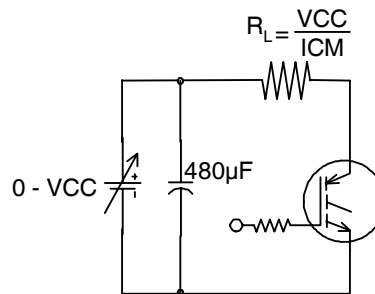

Figure 20. Pulsed Collector Current Test Circuit

IRG4IBC20FDPbF



TO-220AB Full-Pak Package Outline

Dimensions are shown in millimeters (inches)

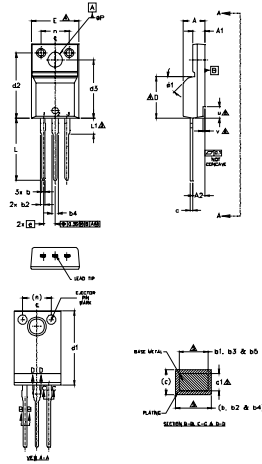

SYMBOL	DIMENSIONS				NOTES
	MILLIMETERS		INCHES		
	MIN.	MAX.	MIN.	MAX.	
A	4.57	4.83	.180	.190	
A1	2.57	2.83	.101	.111	
A2	2.51	2.93	.099	.115	
b	0.81	0.94	.024	.037	
b1	0.81	0.89	.024	.035	
b2	0.76	1.27	.030	.050	
b3	0.76	1.22	.030	.048	
b4	1.02	1.52	.040	.060	
b5	1.02	1.47	.040	.058	
c	0.33	0.63	.013	.025	
c1	0.33	0.58	.013	.023	
D	8.66	9.80	.341	.386	
d1	15.80	16.15	.622	.635	
d2	13.97	14.22	.550	.560	
d3	12.30	12.93	.484	.509	
E	9.63	10.75	.379	.423	
e	2.54 SSC		.100 SSC		
L	13.20	13.72	.520	.540	
L1	3.37	3.67	.122	.145	
n	6.05	6.60	.238	.260	
ØP	3.05	3.45	.120	.136	
u	2.40	2.50	.094	.098	
y	0.40	0.50	.016	.020	
Ø1	-	45°	-	45°	

NOTES
 1.0 DIMENSIONING AND TOLERANCING AS PER ASME Y14.5 M-1994.
 2.0 DIMENSIONS ARE SHOWN IN MILLIMETERS (INCHES).
 3.0 LEAD DIMENSION AND PITCH ARE TO BE FILLED IN L1.
 4.0 DIMENSION D & E DO NOT INCLUDE MOLDED FLASH. MOLDED FLASH SHALL NOT EXCEED .007" (0.175) PER SIDE. THESE DIMENSIONS ARE MEASURED AT THE OUTER MOST EXTREMITY OF THE PLASTIC BODY.
 5.0 DIMENSION D1, D2, D3 & E1 APPLY TO BASE METAL ONLY.
 6.0 STEP OPTIONAL ON PLASTIC BODY DEFINED BY DIMENSIONS a & b.
 7.0 CONTROLLING DIMENSION - NOTES.

LEAD ASSIGNMENTS
 1 - GATE
 2 - DIODE
 3 - SOURCE

MATERIALS
 1 - GATE
 2 - DIODE
 3 - EMITTER

TO-220AB Full-Pak Part Marking Information

EXAMPLE: THIS IS AN IRFI840G
 WITH ASSEMBLY
 LOT CODE 3432
 ASSEMBLED ON WW 24, 2001
 IN THE ASSEMBLY LINE 'K'

Note: 'P' in assembly line position indicates 'Lead-Free'

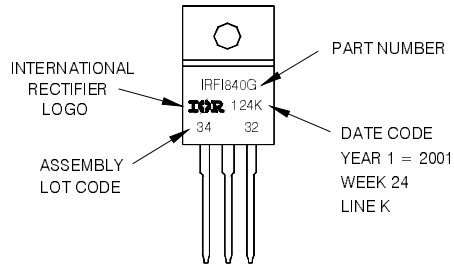

TO-220AB Full-Pak package is not recommended for Surface Mount Application.

Notes:

- ① Repetitive rating: $V_{GE}=20V$; pulse width limited by maximum junction temperature (figure 20)
- ② $V_{CC}=80\%(V_{CES})$, $V_{GE}=20V$, $L=10\mu H$, $R_G = 50\Omega$ (figure 19)
- ③ Pulse width $\leq 80\mu s$; duty factor $\leq 0.1\%$.
- ④ Pulse width $5.0\mu s$, single shot.
- ⑤ $t = 60s$, $f = 60Hz$

Note: For the most current drawing please refer to IR website at <http://www.irf.com/package/>

Data and specifications subject to change without notice.



IR WORLD HEADQUARTERS: 233 Kansas St., El Segundo, California 90245, USA Tel: (310) 252-7105
 TAC Fax: (310) 252-7903

Visit us at www.irf.com for sales contact information.01/2010
www.irf.com

X-ON Electronics

Largest Supplier of Electrical and Electronic Components

Click to view similar products for [IGBT Transistors](#) category:

Click to view products by [Infineon](#) manufacturer:

Other Similar products are found below :

[748152A](#) [FGH60T65SHD_F155](#) [APT100GT60B2RG](#) [APT13GP120BG](#) [APT20GN60BG](#) [APT20GT60BRDQ1G](#) [APT25GN120B2DQ2G](#)
[APT35GA90BD15](#) [APT36GA60BD15](#) [APT40GP60B2DQ2G](#) [APT40GP90B2DQ2G](#) [APT50GN120B2G](#) [APT50GT60BRG](#)
[APT64GA90B2D30](#) [APT70GR120J](#) [NGTB10N60FG](#) [NGTB30N60L2WG](#) [NGTG25N120FL2WG](#) [IGP30N60H3XKSA1](#) [STGB15H60DF](#)
[STGFW20V60DF](#) [STGFW30V60DF](#) [STGFW40V60F](#) [STGWA25H120DF2](#) [FGB3236_F085](#) [APT25GN120BG](#) [APT25GR120S](#)
[APT30GN60BDQ2G](#) [APT30GN60BG](#) [APT30GP60BG](#) [APT30GS60BRDQ2G](#) [APT30N60BC6](#) [APT35GP120JDQ2](#) [APT36GA60B](#)
[APT45GR65B2DU30](#) [APT50GP60B2DQ2G](#) [APT68GA60B](#) [APT70GR65B](#) [APT70GR65B2SCD30](#) [GT50JR22\(STA1ES\)](#) [TIG058E8-TL-H](#)
[IDW40E65D2](#) [NGTB50N60L2WG](#) [STGB10H60DF](#) [STGB20V60F](#) [STGB40V60F](#) [STGFW80V60F](#) [IGW40N120H3FKSA1](#)
[RJH60D7BDPQ-E0#T2](#) [APT40GR120B](#)