



Micro Commercial Components



Micro Commercial Components
20736 Marilla Street Chatsworth
CA 91311
Phone: (818) 701-4933
Fax: (818) 701-4939

MMBZ5221B
THRU
MMBZ5259B

Features

- Halogen free available upon request by adding suffix "-HF"
Lead Free Finish/RoHS Compliant ("P" Suffix designates RoHS Compliant. See ordering information)
Epoxy meets UL 94 V-0 flammability rating
Moisture Sensitivity Level 1
Wide Voltage Range Available
Small Outline Package For Space Savings
High Temp Soldering: 260°C for 10 Seconds At Terminals
Surface Mount Package

Maximum Ratings

- Operating Junction Temperature: -55°C to +150°C
Storage Temperature: -55°C to +150°C
Maximum Thermal Resistance; 357°C/W Junction To Ambient

Maximum Ratings @ 25°C Unless Otherwise Specified

Table with 4 columns: Parameter, Symbol, Value, Unit. Rows include Zener Current (IF, 100 mA), Maximum Forward Voltage (VF, 1.2 V), Power Dissipation (Pd, 350 mWatt), and Peak Forward Surge Current (IFSM, 4.0 Amps).

NOTES:

- A. Mounted on FR4 PC board with our suggested solder pad layout.
B. Measured on 8.3ms, single half sine-wave or equivalent square wave, duty cycle = 4 pulses per minute maximum.

*Pin Configuration - Top View

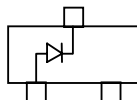

350 mW
Zener Diode
2.4 to 39 Volts

SOT-23

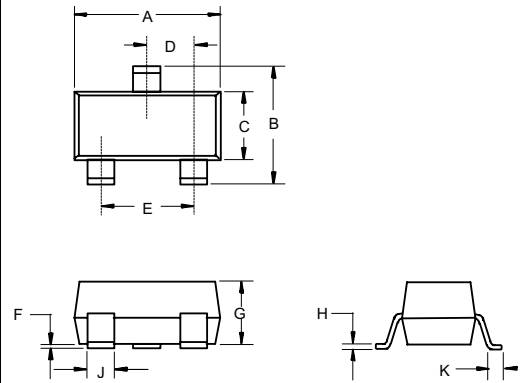
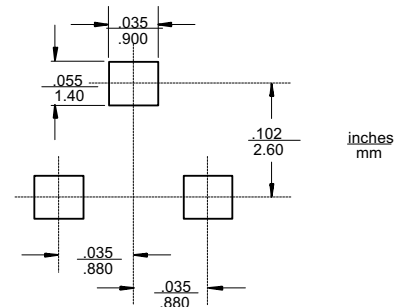

Table titled 'DIMENSIONS' with columns for DIM, INCHES (MIN, MAX), MM (MIN, MAX), and NOTE. It lists dimensions A through K with their respective minimum and maximum values in both inches and millimeters.

Suggested Solder Pad Layout



MMBZ5221B thru MMBZ5259B



ELECTRICAL CHARACTERISTICS @25°C

MCC PART NUMBER	MARKING	NOMINAL ZENER VOLTAGE $V_Z @ I_{ZT}$	TEST CURRENT I_{ZT}	MAXIMUM ZENER IMPEDANCE 'B' SUFFIX ONLY		MAXIMUM REVERSE LEAKAGE CURRENT	
		VOLTS	mA	$Z_{ZT} @ I_{ZT}$	$Z_{ZK} @ I_{ZK} = 0.25mA$	$I_R @ V_R$	VOLTS
MMBZ5221B	KC1/C1	2.4	20	30	1200	100	1.0
MMBZ5222B	KC2/C2	2.5	20	30	1250	100	1.0
MMBZ5223B	KC3/C3	2.7	20	30	1300	75	1.0
MMBZ5225B	KC5/C5	3.0	20	29	1600	50	1.0
MMBZ5226B	KG1/D1	3.3	20	28	1600	25	1.0
MMBZ5227B	KG2/D2	3.6	20	24	1700	15	1.0
MMBZ5228B	KG3/D3	3.9	20	23	1900	10	1.0
MMBZ5229B	KG4/D4	4.3	20	22	2000	5.0	1.0
MMBZ5230B	KG5/D5	4.7	20	19	1900	5.0	2.0
MMBZ5231B	KE1/E1	5.1	20	17	1600	5.0	2.0
MMBZ5232B	KE2/E2	5.6	20	11	1600	5.0	3.0
MMBZ5233B	KE3/E3	6.0	20	7.0	1600	5.0	3.5
MMBZ5234B	KE4/E4	6.2	20	7.0	1000	5.0	4.0
MMBZ5235B	KE5/E5	6.8	20	5.0	750	3.0	5.0
MMBZ5236B	KF1/F1	7.5	20	6.0	500	3.0	6.0
MMBZ5237B	KF2/F2	8.2	20	8.0	500	3.0	6.5
MMBZ5238B	KF3/F3	8.7	20	8.0	600	3.0	6.5
MMBZ5239B	KF4/F4	9.1	20	10	600	3.0	7.0
MMBZ5240B	KF5/F5	10	20	17	600	3.0	8.0
MMBZ5241B	KH1/H1	11	20	22	600	2.0	8.4
MMBZ5242B	KH2/H2	12	20	30	600	1.0	9.1
MMBZ5243B	KH3/H3	13	9.5	13	600	0.5	9.9
MMBZ5244B	KH4/H4	14	9.0	15	600	0.1	10
MMBZ5245B	KH5/H5	15	8.5	16	600	0.1	11
MMBZ5246B	KJ1/J1	16	7.8	17	600	0.1	12
MMBZ5248B	KJ3/J3	18	7.0	21	600	0.1	14
MMBZ5250B	KJ5/J5	20	6.2	25	600	0.1	15
MMBZ5251B	KK1/K1	22	5.6	29	600	0.1	17
MMBZ5252B	KK2/K2	24	5.2	33	600	0.1	18
MMBZ5254B	KK4/K4	27	5.0	41	600	0.1	21
MMBZ5255B	KK5/K5	28	4.5	44	600	0.1	21
MMBZ5256B	KM1/M1	30	4.2	49	600	0.1	23
MMBZ5257B	KM2/M2	33	3.8	58	700	0.1	25
MMBZ5258B	KM3/M3	36	3.4	70	700	0.1	27
MMBZ5259B	KM4/M4	39	3.2	80	800	0.1	30

Note:

- Tolerance and Type Number Designation. The type numbers listed have a standard tolerance on the nominal zener voltage of $\pm 5\%$.
- Specials Available Include:
 - Nominal zener voltages between the voltages shown and tighter voltage tolerances.
 - Matched sets.
- Zener Voltage (V_Z) Measurement. Guarantees the zener voltage when measured at 90 seconds while maintaining the lead temperature (T_L) at 30°C , from the diode body.
- Zener Impedance (Z_Z) Derivation. The zener impedance is derived from the 60 cycle ac voltage, which results when an AC current having an rms value equal to 10% of the dc zener current (I_{ZT} or I_{ZK}) is superimposed on I_{ZT} or I_{ZK} .
- Surge Current (I_R) Non-Repetitive. The rating listed in the electrical characteristics table is maximum peak, non-repetitive, reverse surge current of 1/2 square wave or equivalent sine wave pulse of 1/120 second duration superimposed on the test current, I_{ZT} , per JEDEC registration; however, actual device capability is as described in Figure 5.

MMBZ5221B thru MMBZ5259B

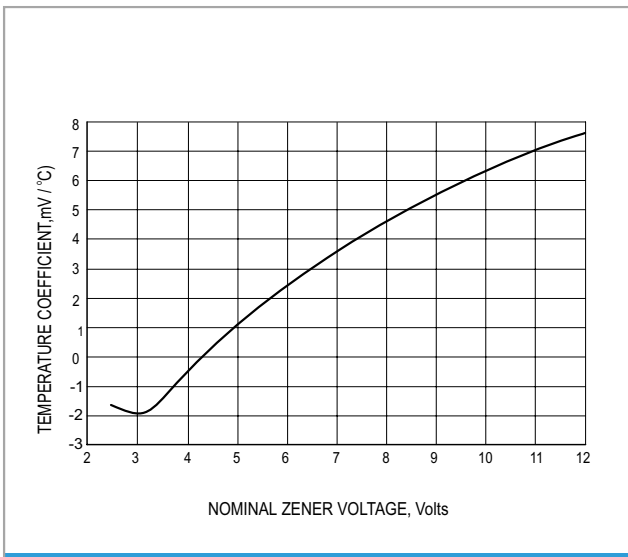

TYPICAL REVERSE CURRENT

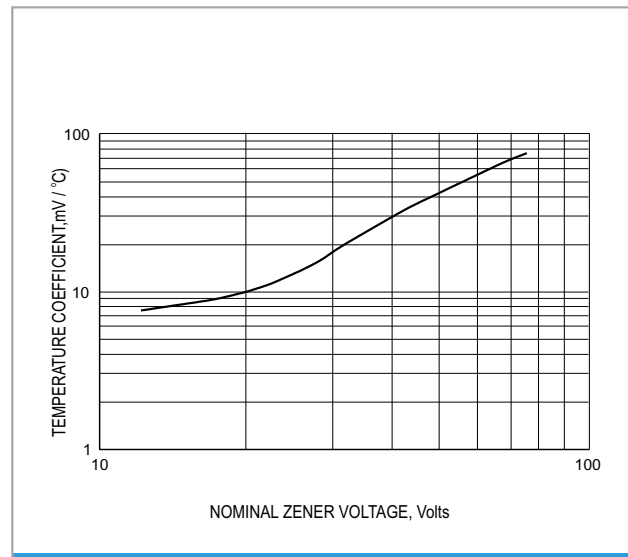

STEADY STATE POWER DERATING

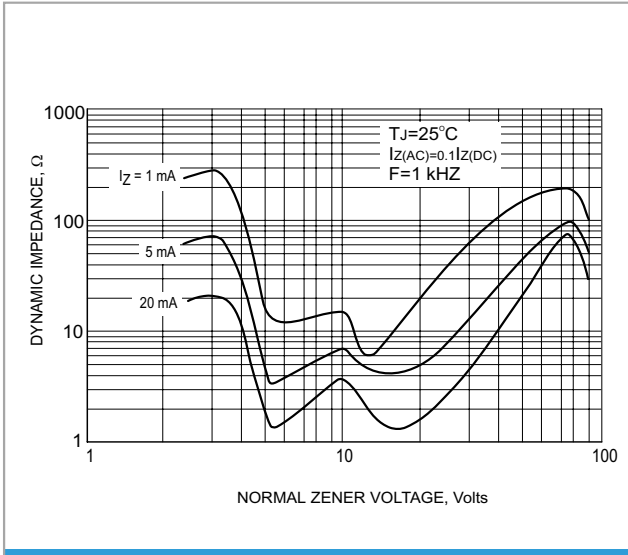

EFFECT OF ZENER VOLTAGE ON ZENER IMPEDANCE

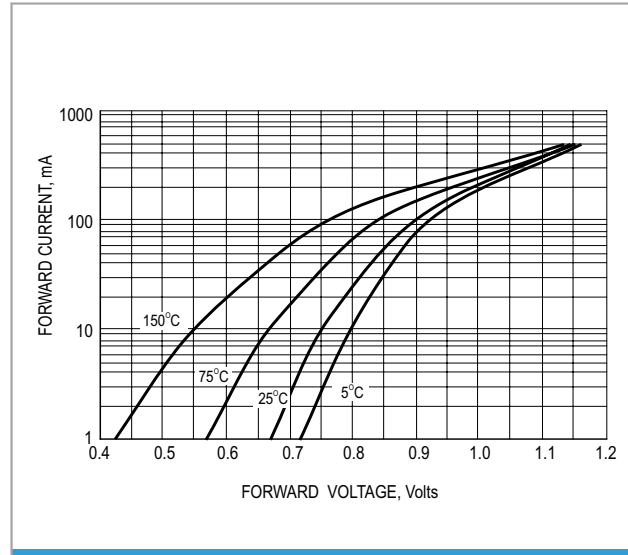

TYPICAL FORWARD VOLTAGE

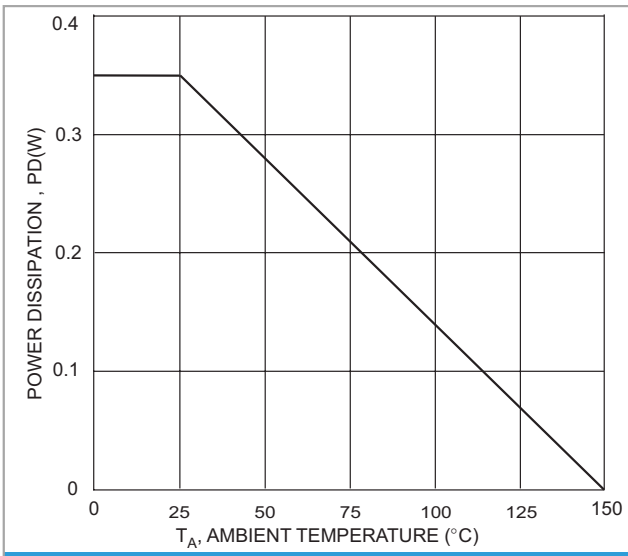

STEADY STATE POWER DERATING

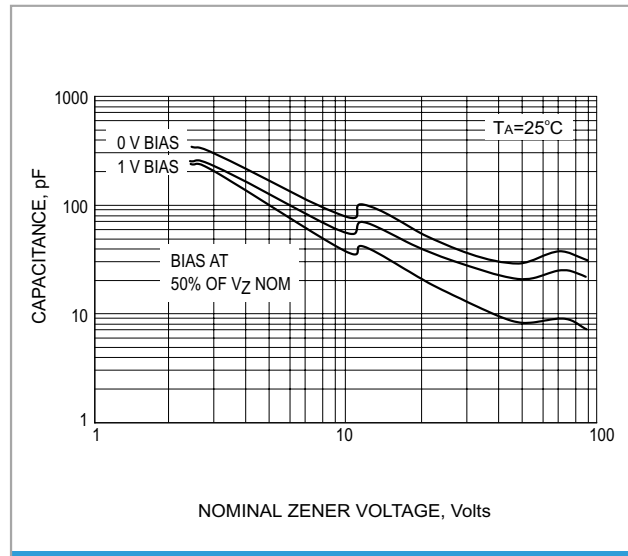

TYPICAL CAPACITANCE

MMBZ5221B thru MMBZ5259B

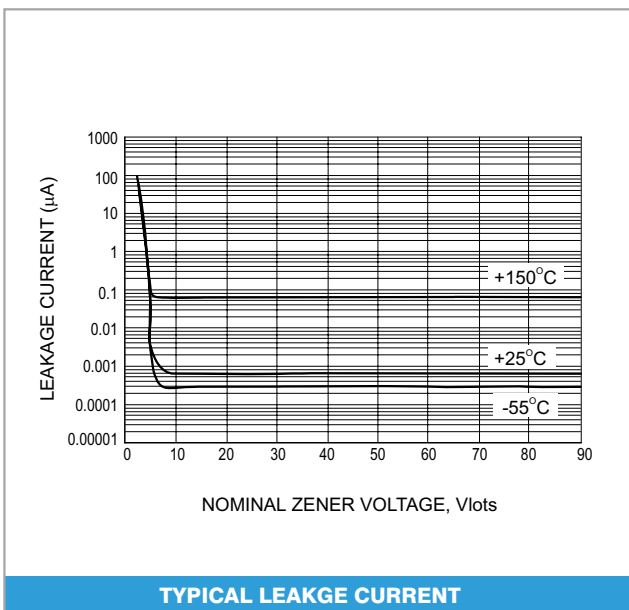
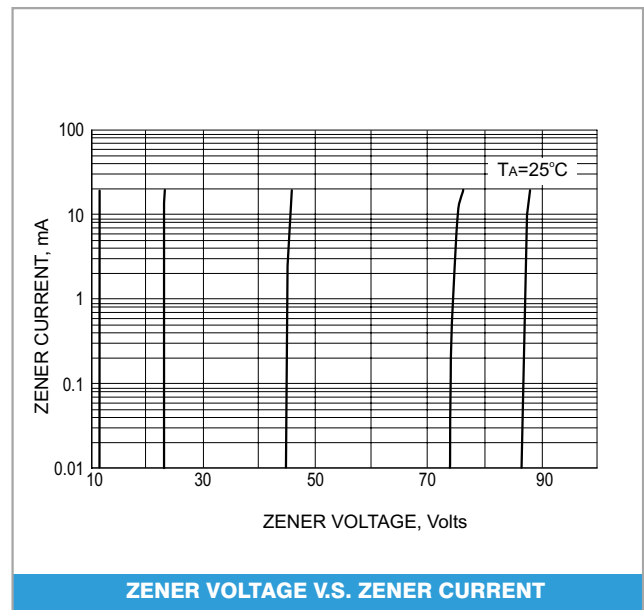
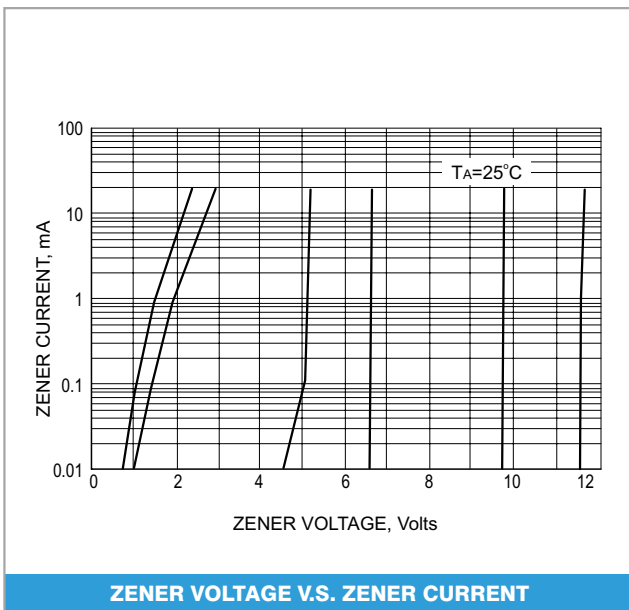



TM

Micro Commercial Components

Ordering Information :

Device	Packing
Part Number-TP	Tape&Reel: 3Kpcs/Reel

Note : Adding "-HF" suffix for halogen free, eg. Part Number-TP-HF

IMPORTANT NOTICE

Micro Commercial Components Corp. reserves the right to make changes without further notice to any product herein to make corrections, modifications , enhancements , improvements , or other changes . **Micro Commercial Components Corp .** does not assume any liability arising out of the application or use of any product described herein; neither does it convey any license under its patent rights ,nor the rights of others . The user of products in such applications shall assume all risks of such use and will agree to hold **Micro Commercial Components Corp .** and all the companies whose products are represented on our website, harmless against all damages.

LIFE SUPPORT

MCC's products are not authorized for use as critical components in life support devices or systems without the express written approval of Micro Commercial Components Corporation.

CUSTOMER AWARENESS

Counterfeiting of semiconductor parts is a growing problem in the industry. Micro Commercial Components (MCC) is taking strong measures to protect ourselves and our customers from the proliferation of counterfeit parts. MCC strongly encourages customers to purchase MCC parts either directly from MCC or from Authorized MCC Distributors who are listed by country on our web page cited below. Products customers buy either from MCC directly or from Authorized MCC Distributors are genuine parts, have full traceability, meet MCC's quality standards for handling and storage. **MCC will not provide any warranty coverage or other assistance for parts bought from Unauthorized Sources.** MCC is committed to combat this global problem and encourage our customers to do their part in stopping this practice by buying direct or from authorized distributors.

www.mccsemi.com

X-ON Electronics

Largest Supplier of Electrical and Electronic Components

Click to view similar products for [Zener Diodes](#) category:

Click to view products by [Micro Commercial Components \(MCC\)](#) manufacturer:

Other Similar products are found below :

[MMSZ5245BS-7-F](#) [RKZ13B2KG#P1](#) [RKZ5.6B2KJ#R1](#) [EDZTE6113B](#) [EDZTE6116B](#) [EDZTE616.8B](#) [1N747A](#) [1N966B](#) [NTE5116A](#)
[NTE5121A](#) [NTE5139A](#) [NTE5147A](#) [NTE5152A](#) [NTE5156A](#) [NTE5164A](#) [JANS1N4974US](#) [SMAJ4764A-TP](#) [RKZ5.1BKU#P6](#)
[3SMAJ5946B-TP](#) [3SMAJ5950B-TP](#) [3SMBJ5920B-TP](#) [3SMBJ5925B-TP](#) [TDZTR24](#) [441774C](#) [MMSZ4678-TP](#) [BZG04-36](#) [BZG05C9V1-](#)
[HE3-TR](#) [HZM30NBTR-E](#) [UDZTE-175.1B](#) [3SMAJ5945B-TP](#) [3SMAJ5947B-TP](#) [3SMBJ5941B-TP](#) [DL4746A-TP](#) [RKZ18B2KK#R1](#)
[RKZ10B2KL#R1](#) [RKZ6.8B2KL#R1](#) [RKZ8.2B2KL#R1](#) [DZ2S240M0L](#) [SMAZ27-TP](#) [SMBZ5920B-E3/52](#) [ZMM3.0](#) [RD16UM-T1-A](#) [RD39S-](#)
[T1-A](#) [RD9.1S-T1-A](#) [RD10S-T1-A](#) [RD20S-T1-A](#) [RD2.2S-T1-A](#) [RD2.7UM-T1-A](#) [HZM24NB1TL-E](#) [HZM2.7NB2TL-E](#)