

R7 SERIES ROCKER SWITCH

ANTI-VANDAL SWITCHES
DETECTOR SWITCHES
DIP SWITCHES
KEYLOCK SWITCHES
NAVIGATION SWITCHES
PUSHBUTTON SWITCHES
ROCKER SWITCHES
ROTARY SWITCHES
SLIDE SWITCHES
SNAP ACTION SWITCHES
TACTILE SWITCHES
TOGGLE SWITCHES
CAP OPTIONS

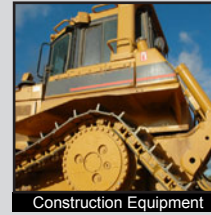

APPLICATIONS / MARKETS

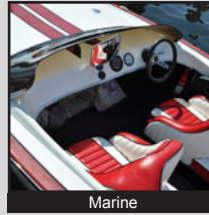

RoHS

SPECIFICATIONS

Contact Rating: 20(8)A @ 125/250VAC, 50/60 Hz, μ T55;
16A @ 6-30VDC, 50/60 Hz, μ T55;
20(8)A @ 125/250VAC, 50/60 Hz, μ T85/T55;
16A @ 6-30VDC, 50/60 Hz, μ T85/T55
Electrical Life: 10,000 Cycles per UL61058
Contact Resistance: 20m Ω Max. initial
Insulation Resistance: 100 M Ω Min. @ 500VDC
Dielectric Strength: 1,500VAC for 1 minute
Operating Temperature: 0°C to 55°C
Storage Temperature: -20°C to 85°C
Agency Approvals: cURus
Contact Arrangement: SP or DP up to 3 positions
Moisture Protection: IP67 to front panel
Panel Thickness: 1.5 - 4.5mm

FEATURES & BENEFITS

- Rated to IP67
- UL Certified
- Ergonomic design
- Solder, faston or screw termination
- LED Illumination options
- Multiple functions
- Many actuator styles
- Custom actuator marking available

PART NUMBER CONFIGURATOR

Series	No. of Poles	Functions	Terminals	Actuator Style**	Marking**	Lamp Type	Actuator Color**	Ratings/Temp	LED 1 Color	LED 2 Color	Lens Color**
<input type="text"/>	<input type="text"/>	<input type="text"/>	<input type="text"/>	<input type="text"/>	<input type="text"/>	<input type="text"/>	<input type="text"/>	<input type="text"/>	<input type="text"/>	<input type="text"/>	<input type="text"/>
R7	1 - SP 2 - DP	1 - On-Off 2 - On-On 3 - On-Off-On [‡] 4 - (On)-Off 5 - (On)-On 6 - (On)-Off-(On) 7 - (On)-Off-On 8 - On-(Off)	F - Faston 1/4" S - Solder Lug W - Screw	XX - None A1 - Hard PC A2 - Hard PC A3 - Hard PC B1 - Soft TPR B2 - Soft TPR B3 - Soft TPR B4 - Soft TPR C1 - Hard PC C2 - Hard PC C3 - Hard PC D1 - Hard PC D2 - Hard PC D3 - Hard PC E1 - Soft TPR E2 - Soft TPR E3 - Soft TPR F1 - Soft TPR F2 - Soft TPR F3 - Soft TPR	SXXX	N - None 1 - 6VDC 2 - 12VDC 3 - 24VDC 4 - 125VAC 5 - 250VAC	X - None B - Black G - Gray	B - 20(8)A @ 125/250VAC, 50/60 Hz, μ T55 D - 16A @ 6-30VDC, 50/60 Hz, μ T55 2 - 20(8)A @ 125/250VAC, 50/60 Hz, μ T85/T55 [†] 4 - 16A @ 6-30VDC, 50/60 Hz, μ T85/T55 [†]	N - None R - Red A - Amber G - Green	N - None R - Red A - Amber G - Green	X - None W - White G - Green

() denotes momentary
[‡] Function 3 is used only with ratings options 2 and 4

** When creating a part number for just the switch body, choose the "X" options for those marked in red. Use all options in the main part number configurator when ordering the switch body assembled with the actuator.

EXAMPLE ORDERING CODES:
 Complete Switch: R712FB1-SXXXNBBNXX
 R711FB2-SXXX2BDANW
 Switch Body: R712FXX-SXXX2XDGRX
 R711FXX-SXXXNXDNXX
 Switch Actuator: R7F3BLKW
 R7A1BLKX

ACTUATOR CONFIGURATOR*

Series	Actuator Style	Actuator Color	Lens Color	Marking
<input type="text"/>	<input type="text"/>	<input type="text"/>	<input type="text"/>	<input type="text"/>
R7	XX A1 A2 D1 A3 D2 B1 D3 B2 E1 B3 E2 B4 E3 C1 F1 C2 F2 C3 F3	BLK - Black GRY - Gray	X - None W - White G - Green	SXXX

*You can choose to order just the actuator as a separate part number

Specifications subject to change without notice



E-SWITCH®

www.e-switch.com

800.867.2717

R7 SERIES ROCKER SWITCH

BODY DIMENSIONS

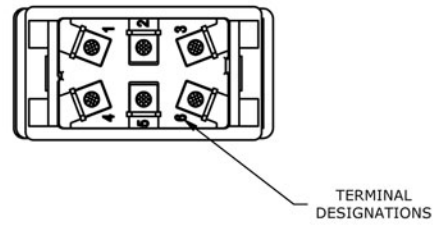
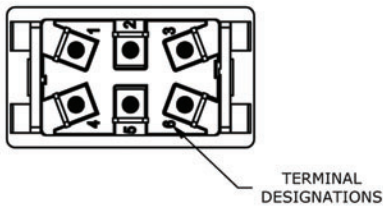
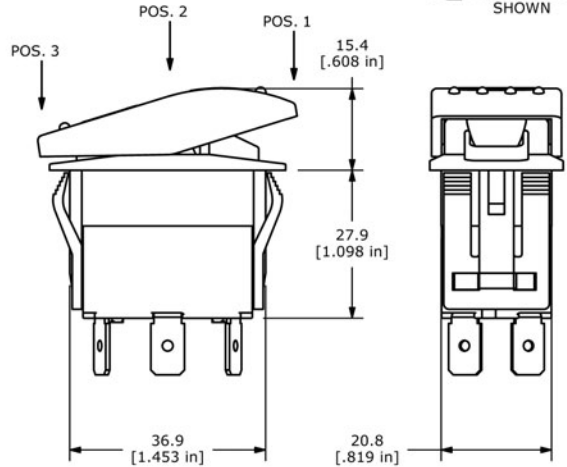
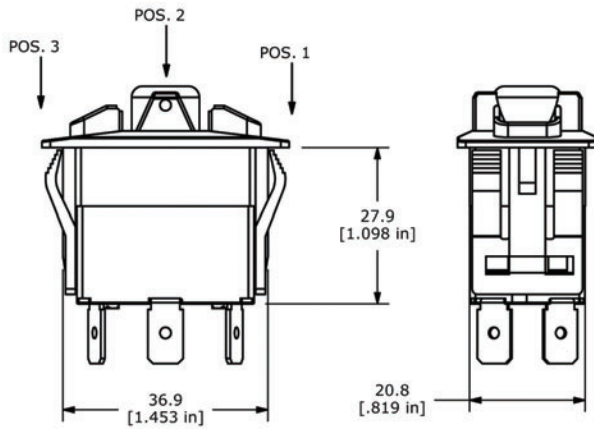
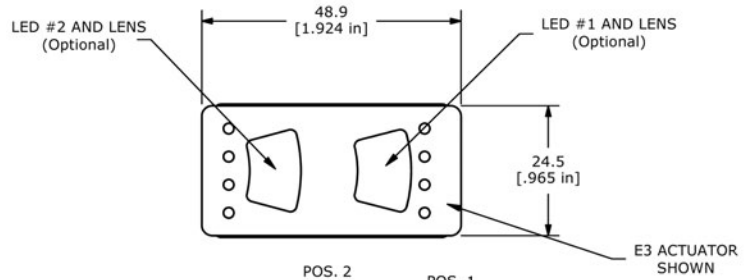
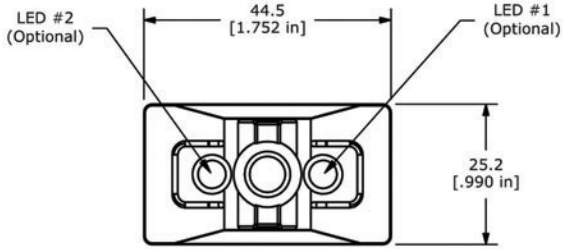

**Double Pole
without actuator**

**Double Pole
with actuator**

(E3 actuator shown)

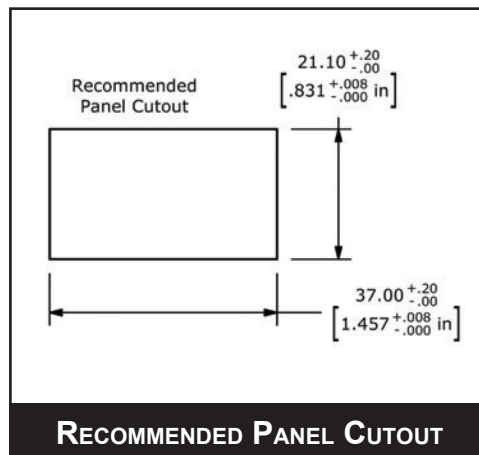

TERMINATION OPTIONS

- ANTI-VANDAL SWITCHES
- DETECTOR SWITCHES
- DIP SWITCHES
- KEYLOCK SWITCHES
- NAVIGATION SWITCHES
- PUSHBUTTON SWITCHES
- ROCKER SWITCHES**
- ROTARY SWITCHES
- SLIDE SWITCHES
- SNAP ACTION SWITCHES
- TACTILE SWITCHES
- TOGGLE SWITCHES
- CAP OPTIONS

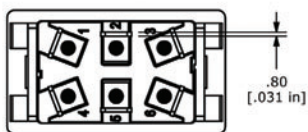
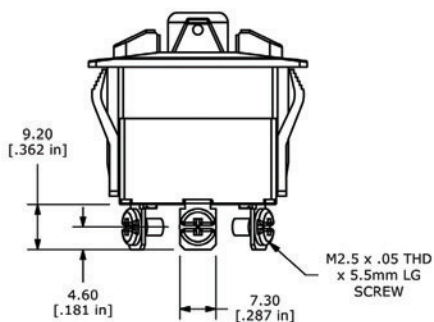
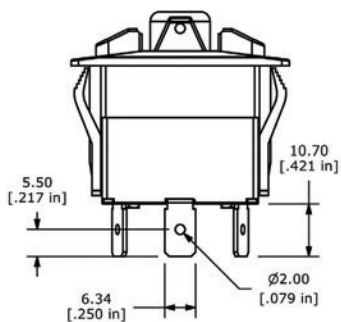
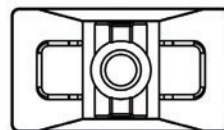
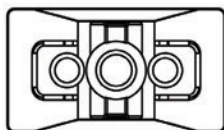

FASTON 1/4"

SCREW

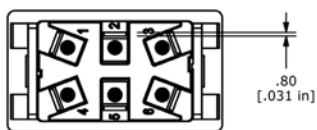
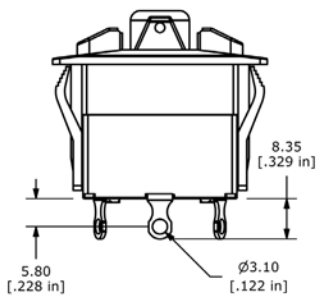
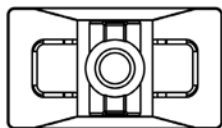

SOLDER



R7 SERIES ROCKER SWITCH

ACTUATOR OPTIONS

A
Hard PC



A1



A2



A3

B
Soft TPR



B1



B2



B3



B4

C
Hard PC



C1



C2



C3

D
Hard PC



D1



D2



D3

E
Soft TPR



E1



E2

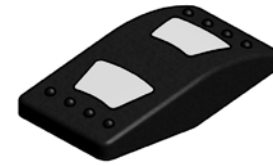

E3

F
Soft TPR



F1



F2



F3

TPR = Thermal Plastic Rubber

PC = Polycarbonate

ANTI-VANDAL SWITCHES
DETECTOR SWITCHES
DIP SWITCHES
KEYLOCK SWITCHES
NAVIGATION SWITCHES
PUSHBUTTON SWITCHES
ROCKER SWITCHES
ROTARY SWITCHES
SLIDE SWITCHES
SNAP ACTION SWITCHES
TACTILE SWITCHES
TOGGLE SWITCHES
CAP OPTIONS



E-SWITCH®

www.e-switch.com

800.867.2717

5

R7 SERIES ROCKER SWITCH

SCHEMATICS



SPST
Non Illuminated

For R711, R714, R718

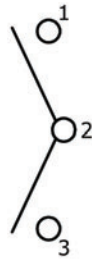

SPDT
Non Illuminated

For R712, R713, R715,
R716, R717

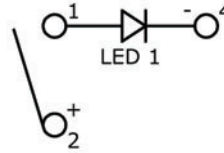

SPST
with LED #1

For R711, R714, R718

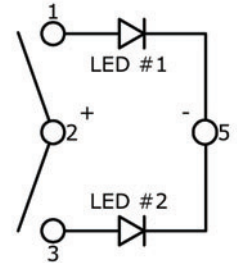

SPDT
with 2 LEDs

For R712, R713, R715,
R716, R717

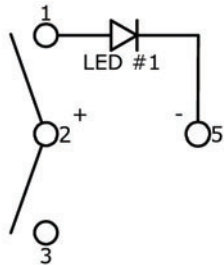

SPDT
with LED #1

For R712, R713, R715,
R716, R717

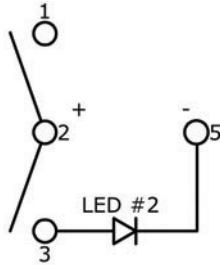

SPDT
with LED #2

For R712, R713, R715,
R716, R717

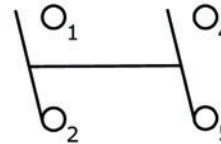

DPST
Non Illuminated

For R721, R724, R728

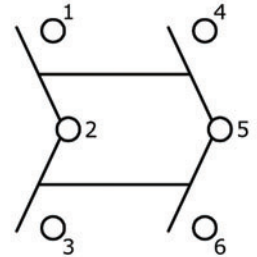

DPDT
Non Illuminated

For R722, R723, R725,
R726, R727

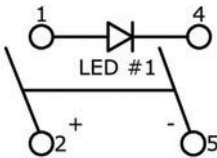

DPST
with LED #1

For R721, R724, R728

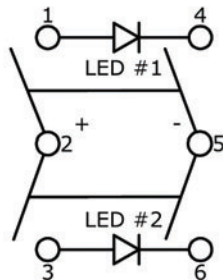

DPDT
with 2 LEDs

For R722, R723, R725,
R726, R727

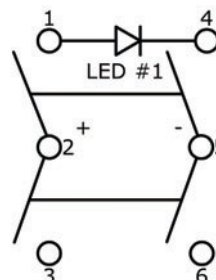

DPDT
with LED #1

For R722, R723, R725,
R726, R727

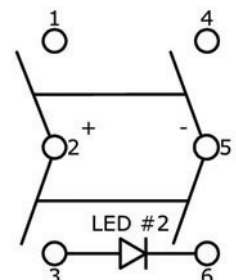

DPDT
with LED #2

For R722, R723, R725,
R726, R727



X-ON Electronics

Largest Supplier of Electrical and Electronic Components

Click to view similar products for [Rocker Switches](#) category:

Click to view products by [E-Switch](#) manufacturer:

Other Similar products are found below :

[VKD2GHNB-00000-000](#) [VSD2GNNB-00000-000](#) [6-1571986-5](#) [6-1571986-9](#) [7036WWCDBX653+U622](#) [8055K52Z7V](#) [8138K20E6M50](#)
[FMC18A2200002](#) [84206L](#) [84312LX](#) [PREDD4-07F-BB0FW](#) [PREDD5-07F-BB0GW](#) [PRFDD1-16F-BB000](#) [PRFDD3-16F-BB000](#) [1-](#)
[1634201-0](#) [999-16702-001](#) [A101J2ZQ004](#) [A101J4ZQ004](#) [A101J51CB0004](#) [A107J51ZQ0004](#) [A201J1AQ004](#) [A201J1AV2Q004](#)
[A201J3ZB004](#) [A201J50ZQ004](#) [A203J51ZQ0004](#) [A226L11YZQ](#) [A22L11A](#) [A435S1YZQ](#) [H8500XBBBBL-A](#) [H8653VBBG2577W](#)
[HB130CHNWWNAAC](#) [1251.0303](#) [AE205J60V3B004](#) [RH110C2NBB](#) [1352.0107](#) [1363.0201](#) [AML25GBF2AA03GR](#) [1571099-3](#) [1571987-4](#)
[1571987-5](#) [1571989-7](#) [B123J77V7B2](#) [B226J50W4Q22P](#) [B433J37ZQ22M](#) [160212E](#) [1801.1164](#) [1831.1102](#) [1833.3402](#) [1837.1118](#) [1838.8302](#)