

REV.	ECN NO.	DATE	SIGN	DESCRIPTION
A	Initial Release	2016/12/01	Wes Fan	Change Rev.01 To Rev.A

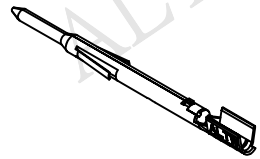

Male Pin

OR

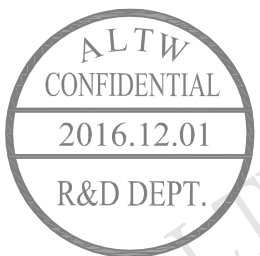
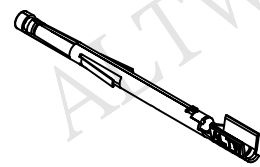

Female Pin

X 50 PCS or 100 PCS

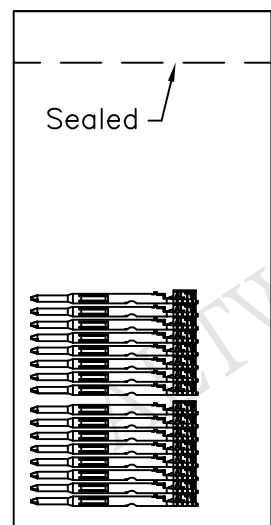

PE Bag

X 1 PCS

Each 50 pcs or 100 pcs pins into a PE bag.

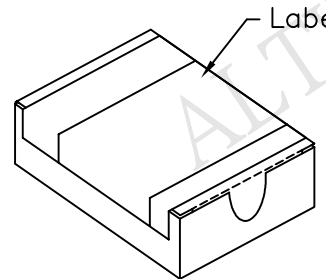

Carton Box: L65 X W55X H25

OR

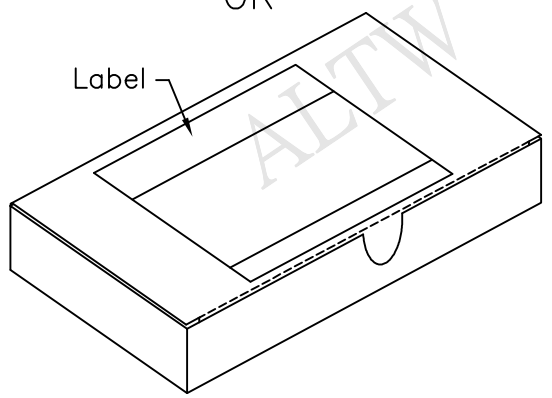

Carton Box: L130 X W55X H25

Each bag with pins into a carton box.  
Each carton box with a label.

Notes:

- \* Pins Material: Phosphor Bronze.
  - \* Bag Material: PE, Clean.
  - \* Box Material: Corrugated Carton, T=1.5mm
- Carton Interior Dimensions: L130 X W55X H25  
L65 X W55X H25

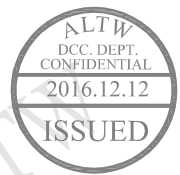

UNIT:mm	TITLE	
TOLERANCE	X-LOK,STPIN,ASSY,CRIMP	
±0.5 mm	SCALE Free	SHEET 1 OF 2
	REV. A	SIZE A4
	QC :Inspection Item	

**Amphenol LTW**  
安費諾亮泰企業股份有限公司

ITEM NO	ASSP-XX-X-A-C-SX	DRAWN BY	Wes Fan	DATE	2016/12/01
DWG NO	ASSP-XX-X-A-C-SX	CHECKED BY	Victor Hung	DATE	2016/12/01
CUSTOMER	ALTW	APPROVED BY	Kevin Hu	DATE	2016/12/01

THIS DOCUMENT IS SUBJECT TO CHANGE WITHOUT NOTICE. IT IS CONFIDENTIAL AND A PROPERTY OF Amphenol LTW. DISCLOSURE TO THIRD PARTY HAS TO BE AUTHORIZED BY Amphenol LTW.

A B C D E F

1 2 3 4 5 6 7 8

REV. A	ECN NO.	DATE	SIGN	DESCRIPTION
	Initial Release	2016/12/01	Wes Fan	Change Rev.01 To Rev.A

Ordering Information:

ASSP-XX-X-A-C-SX

Package Style

SA: Scatter 50Pcs By Box.  
SB: Scatter 100Pcs By Box

Contact Gender

M: Male Pin  
F: Female Pin

Current Rating

05: 5A  
10: 10A  
20: 20A

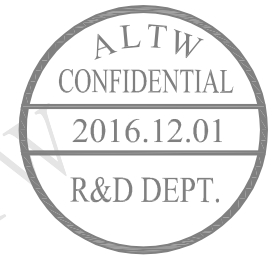
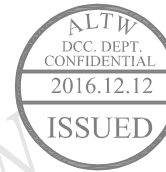

05A Pins

10A Pins

20A Pins

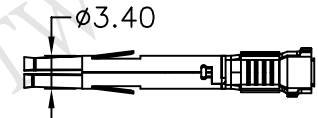
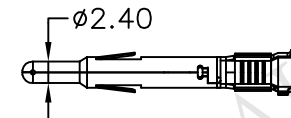
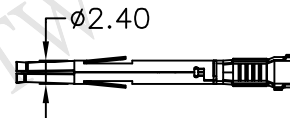
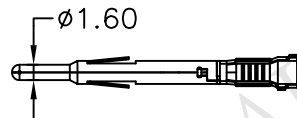
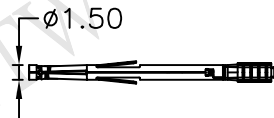
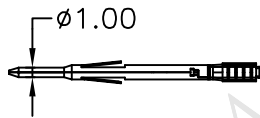
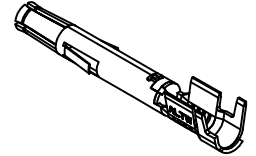
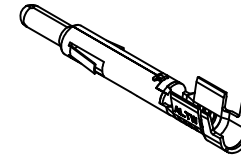
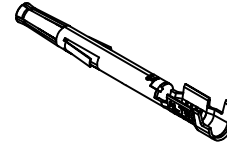
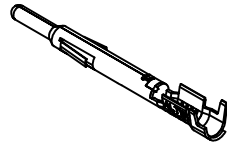
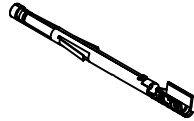
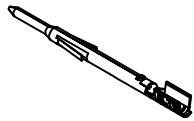

Male Pin

Female Pin

Male Pin

Female Pin

Male Pin

Female Pin

UNIT:mm	
TOLERANCE	
±0.5 mm	

TITLE X-LOK,STPIN,ASSY,CRIMP		
SCALE Free	SHEET 2 OF 2	
REV. A	SIZE A4	QC :Inspection Item

**Amphenol LTW**  
安費諾亮泰企業股份有限公司

ITEM NO ASSP-XX-X-A-C-SX	DRAWN BY Wes Fan	DATE 2016/12/01
DWG NO ASSP-XX-X-A-C-SX	CHECKED BY Victor Hung	DATE 2016/12/01
CUSTOMER ALTW	APPROVED BY Kevin Hu	DATE 2016/12/01

THIS DOCUMENT IS SUBJECT TO CHANGE WITHOUT NOTICE. IT IS CONFIDENTIAL AND A PROPERTY OF Amphenol LTW. DISCLOSURE TO THIRD PARTY HAS TO BE AUTHORIZED BY Amphenol LTW.

F  
E  
D  
C  
B  
A

## X-ON Electronics

Largest Supplier of Electrical and Electronic Components

*Click to view similar products for [Modular Connectors](#) / [Ethernet Connectors](#) category:*

*Click to view products by [Amphenol](#) manufacturer:*

Other Similar products are found below :

[RJE231881317T](#) [MP1010RX-1000](#) [MP44RX-1000](#) [GAX-3-66](#) [GAX-8-62](#) [93606-0253](#) [GD-A-44](#) [GDCX-PA-66-50](#) [GDCX-PN-64](#) [GDCX-PN-66](#) [GDCX-PN-66-50](#) [GDLX-A-66](#) [GDLX-A-88](#) [GDLX-N-66](#) [GDLX-S-88K](#) [GDTX-S-88-50](#) [GDX-PA-1010](#) [GLX-N-1010M-BLK](#) [GLX-N-44M](#) [GLX-S-88M-BLK](#) [GMX-N-1010](#) [GMX-S-1010](#) [GMX-S-66](#) [GMX-SMT2-N-1010](#) [GMX-SMT2-N-64-50](#) [GMX-SMT2-S6-88](#) [GMX-SMT4-N-88](#) [GPX-2-64](#) [GRT1-BT1-5](#) [GSGX-N-2-88](#) [GSX-NS2-88-3.05](#) [GSX-NS2-88-3.05-50](#) [GSX-NS-88-3.05-30](#) [GSX-NS-88-3.05-50](#) [GSX-NS-88-3.68](#) [1-1775629-2](#) [GWLX-S-88-GR](#) [GWLX-S9-88-YG](#) [1300500326](#) [1300500227](#) [1300530003](#) [1300570002](#) [1324640-4](#) [RJ11FTVC2G](#) [RJ11FTVC2N](#) [RJFTVX2SA1G](#) [132764-001](#) [1400000](#) [1413176](#) [1413235](#)