

BN 56

Hexagon head screws
fully threaded

DIN 933
ISO 4017
~UNI 5739

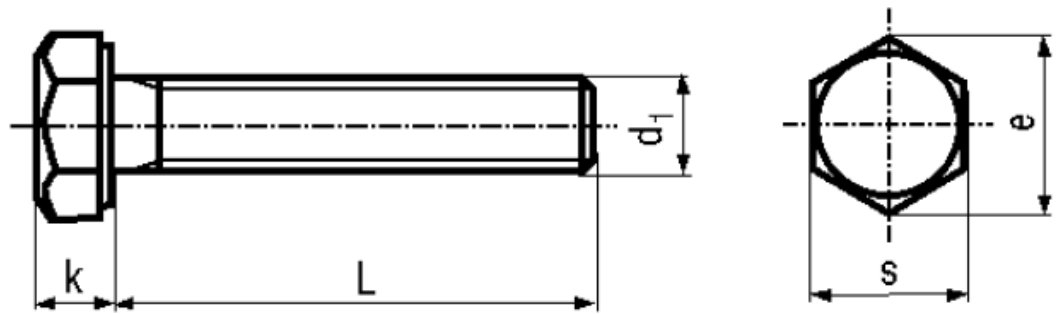

Material	Steel	Tensile strength	800 N/mm²
Surface	zinc plated blue	Proof stress 0,2%	640 N/mm²
Quality	8.8	Elongation after fracture	min. 12%

Article No. - 1049003

d ₁	M4
L	16
e	7,66
k	2,8
s	7

DIN 933: Standard withdrawn
M10, M12, M14, M22; Wrench size according to ISO 272.