

## Zener Diodes

### Features

- Silicon planar zener diodes
- Low profile surface-mount package
- Low leakage current
- Excellent stability
- High temperature soldering: 260 °C/10 s at terminals
- Compliant to RoHS directive 2002/95/EC and in accordance to WEEE 2002/96/EC



**RoHS**  
COMPLIANT

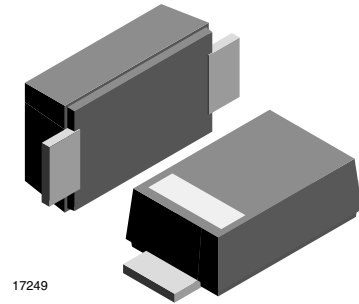

### Mechanical Data

**Case:** JEDEC DO219AB (SMF<sup>®</sup>) plastic case  
**Weight:** approx. 15 mg

### Packaging codes/options:

GS18/10K per 13" reel, (8 mm tape), 50K/box  
GS08/3K per 7" reel, (8 mm tape), 30K/box

### Absolute Maximum Ratings

$T_{amb} = 25\text{ °C}$ , unless otherwise specified

Parameter	Test condition	Symbol	Value	Unit
Power dissipation	$T_L = 80\text{ °C}$	$P_{tot}$	2.3	W
	$T_A = 25\text{ °C}$	$P_{tot}$	0.8 <sup>1)</sup>	W
Non-repetitive peak pulse power dissipation	100 $\mu$ s square pulse <sup>2)</sup>	$P_{ZSM}$	300	W

Notes:

<sup>1)</sup> Mounted on epoxy-glass PCB with 3 mm x 3 mm Cu pads ( $\geq 40\text{ }\mu\text{m}$  thick)

<sup>2)</sup>  $T_j = 25\text{ °C}$  prior to surge

### Thermal Characteristics

$T_{amb} = 25\text{ °C}$ , unless otherwise specified

Parameter	Test condition	Symbol	Value	Unit
Thermal resistance junction to ambient air <sup>1)</sup>		$R_{thJA}$	180	K/W
Thermal resistance junction to lead		$R_{thJL}$	30	K/W
Maximum junction temperature		$T_j$	150	°C
Storage temperature range		$T_{stg}$	- 55 to + 150	°C

Notes:

<sup>1)</sup> Mounted on epoxy-glass PCB with 3 mm x 3 mm Cu pads ( $\geq 40\text{ }\mu\text{m}$  thick)

### Electrical Characteristics

$T_{amb} = 25\text{ °C}$ , unless otherwise specified

Parameter	Test condition	Symbol	Min.	Typ.	Max.	Unit
Forward voltage	$I_F = 0.2\text{ A}$	$V_F$			1.2	V

# BZD17C3V6P to BZD17C200P



Vishay Semiconductors

## Electrical Characteristics

$T_J = 25\text{ }^\circ\text{C}$ , unless otherwise specified

Part number	Marking code	Working voltage <sup>1)</sup>		Differential resistance		Temperature coefficient		Test current	Reverse leakage current	
		$V_Z$ at $I_{ZT}$		$r_{dif}$ at $I_Z$		$\alpha_Z$ at $I_Z$		$I_{ZT}$	$I_R$	$V_R$
		V		$\Omega$		%/°C		mA	$\mu\text{A}$	V
		min.	max.	typ.	max.	min.	max.		max.	
BZD17C3V6P	I0	3.4	3.8	4	8	-0.14	-0.04	100	100	1
BZD17C3V9P	I1	3.7	4.1	4	8	-0.14	-0.04	100	50	1
BZD17C4V3P	I2	4	4.6	4	7	-0.12	-0.02	100	25	1
BZD17C4V7P	I3	4.4	5	3	7	-0.1	0	100	10	1
BZD17C5V1P	I4	4.8	5.4	3	6	-0.08	0.02	100	5	1
BZD17C5V6P	I5	5.2	6	2	4	-0.04	0.04	100	10	2
BZD17C6V2P	I6	5.8	6.6	2	3	-0.01	0.06	100	5	2
BZD17C6V8P	I7	6.4	7.2	1	3	0	0.07	100	10	3
BZD17C7V5P	I8	7	7.9	1	2	0	0.07	100	50	3
BZD17C8V2P	I9	7.7	8.7	1	2	0.03	0.08	100	10	3
BZD17C9V1P	J0	8.5	9.6	2	4	0.03	0.08	50	10	5
BZD17C10P	J1	9.4	10.6	2	4	0.05	0.09	50	7	7.5
BZD17C11P	J2	10.4	11.6	4	7	0.05	0.1	50	4	8.2
BZD17C12P	J3	11.4	12.7	4	7	0.05	0.1	50	3	9.1
BZD17C13P	J4	12.4	14.1	5	10	0.05	0.1	50	2	10
BZD17C15P	J5	13.8	15.6	5	10	0.05	0.1	50	1	11
BZD17C16P	J6	15.3	17.1	6	15	0.06	0.11	25	1	12
BZD17C18P	J7	16.8	19.1	6	15	0.06	0.11	25	1	13
BZD17C20P	J8	18.8	21.2	6	15	0.06	0.11	25	1	15
BZD17C22P	J9	20.8	23.3	6	15	0.06	0.11	25	1	16
BZD17C24P	K0	22.8	25.6	7	15	0.06	0.11	25	1	18
BZD17C27P	K1	25.1	28.9	7	15	0.06	0.11	25	1	20
BZD17C30P	K2	28	32	8	15	0.06	0.11	25	1	22
BZD17C33P	K3	31	35	8	15	0.06	0.11	25	1	24
BZD17C36P	K4	34	38	21	40	0.06	0.11	10	1	27
BZD17C39P	K5	37	41	21	40	0.06	0.11	10	1	30
BZD17C43P	K6	40	46	24	45	0.07	0.12	10	1	33
BZD17C47P	K7	44	50	24	45	0.07	0.12	10	1	36
BZD17C51P	K8	48	54	25	60	0.07	0.12	10	1	39
BZD17C56P	K9	52	60	25	60	0.07	0.12	10	1	43
BZD17C62P	L0	58	66	25	80	0.08	0.13	10	1	47
BZD17C68P	L1	64	72	25	80	0.08	0.13	10	1	51
BZD17C75P	L2	70	79	30	100	0.08	0.13	10	1	56
BZD17C82P	L3	77	87	30	100	0.08	0.13	10	1	62
BZD17C91P	L4	85	96	60	200	0.08	0.13	5	1	68
BZD17C100P	L5	94	106	60	200	0.09	0.13	5	1	75
BZD17C110P	L6	104	116	80	250	0.09	0.13	5	1	82
BZD17C120P	L7	114	127	80	250	0.09	0.13	5	1	91
BZD17C130P	L8	124	141	110	300	0.09	0.13	5	1	100
BZD17C150P	L9	138	156	130	300	0.09	0.13	5	1	110
BZD17C160P	M0	153	171	150	350	0.09	0.13	5	1	120
BZD17C180P	M1	168	191	180	400	0.09	0.13	5	1	130
BZD17C200P	M2	188	212	200	500	0.09	0.13	5	1	150

Note:

<sup>1)</sup> Pulse test:  $t_p \leq 5\text{ ms}$

## Typical Characteristics

$T_{amb} = 25\text{ }^{\circ}\text{C}$ , unless otherwise specified

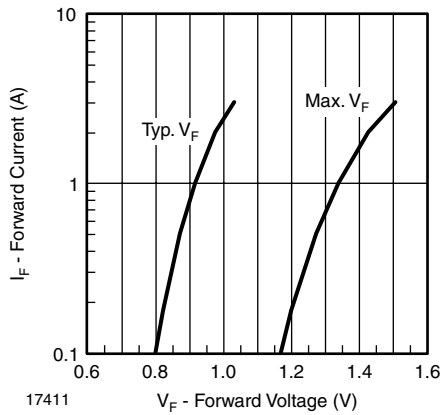

Figure 1. Forward Current vs. Forward Voltage

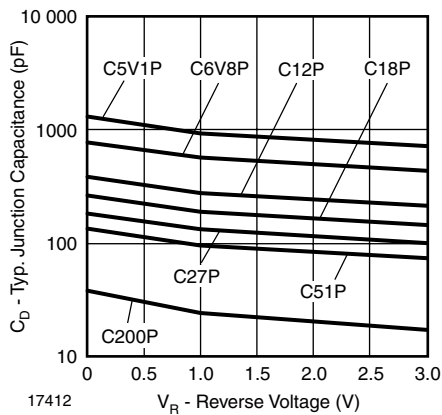

Figure 2. Typ. Diode Capacitance vs. Reverse Voltage

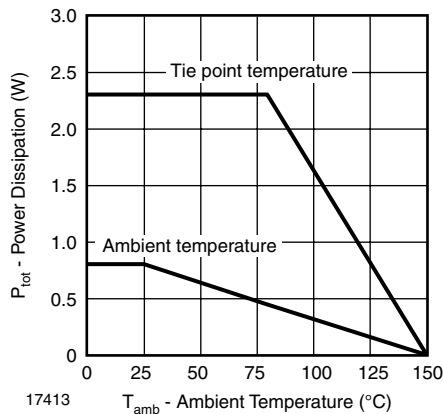

Figure 3. Power Dissipation vs. Ambient Temperature

# BZD17C3V6P to BZD17C200P



Vishay Semiconductors

Package Dimensions in millimeters (inches): DO219AB

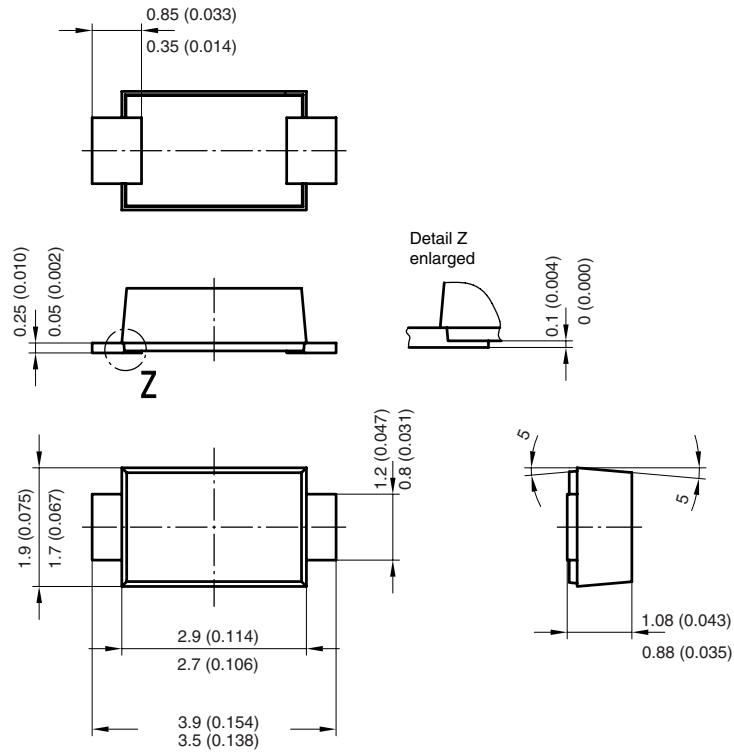

Foot print recommendation:

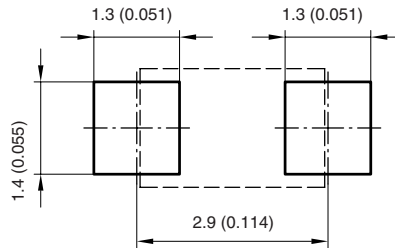

Created - Date: 15. February 2005  
Rev. 3 - Date: 13. March 2007  
Document no.:S8-V-3915.01-001 (4)  
17247

## Blisertape for SMF Dimensions in millimeters

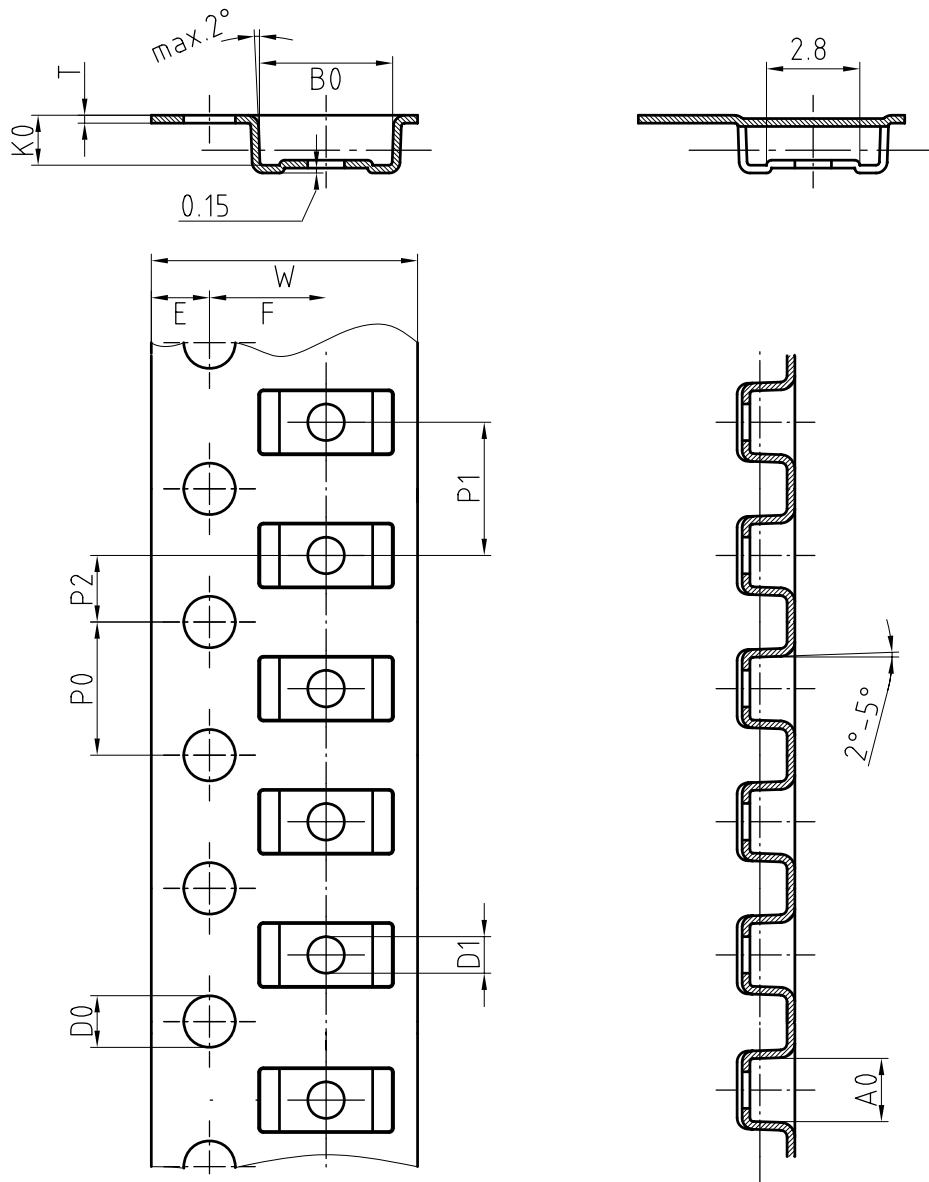

Mat:	A0	B0	K0	W	T	P0	P2	P1	D0	D1	E	F
PS	1.9	4.0	1.5	8.0	0.235	4.0	2.0	4.0	1.5	1	1.75	3.5

18513

## X-ON Electronics

Largest Supplier of Electrical and Electronic Components

*Click to view similar products for [Zener Diodes](#) category:*

*Click to view products by [Vishay](#) manufacturer:*

Other Similar products are found below :

[MMSZ5245BS-7-F](#) [RKZ13B2KG#P1](#) [RKZ5.6B2KJ#R1](#) [EDZTE6113B](#) [EDZTE6116B](#) [EDZTE616.8B](#) [1N747A](#) [1N966B](#) [NTE5116A](#)  
[NTE5121A](#) [NTE5139A](#) [NTE5147A](#) [NTE5152A](#) [NTE5156A](#) [NTE5164A](#) [JANS1N4974US](#) [SMAJ4764A-TP](#) [RKZ5.1BKU#P6](#)  
[3SMAJ5946B-TP](#) [3SMAJ5950B-TP](#) [3SMBJ5920B-TP](#) [3SMBJ5925B-TP](#) [TDZTR24](#) [441774C](#) [MMSZ4678-TP](#) [BZG04-36](#) [BZG05C9V1-](#)  
[HE3-TR](#) [HZM30NBTR-E](#) [UDZTE-175.1B](#) [3SMAJ5945B-TP](#) [3SMAJ5947B-TP](#) [3SMBJ5941B-TP](#) [DL4746A-TP](#) [RKZ18B2KK#R1](#)  
[RKZ10B2KL#R1](#) [RKZ6.8B2KL#R1](#) [RKZ8.2B2KL#R1](#) [DZ2S240M0L](#) [SMAZ27-TP](#) [SMBZ5920B-E3/52](#) [ZMM3.0](#) [RD16UM-T1-A](#) [RD39S-](#)  
[T1-A](#) [RD9.1S-T1-A](#) [RD10S-T1-A](#) [RD20S-T1-A](#) [RD2.2S-T1-A](#) [RD2.7UM-T1-A](#) [HZM24NB1TL-E](#) [HZM2.7NB2TL-E](#)