

# Panasonic

**NEW**

## Amplifier Built-in / U-shaped Micro Photoelectric Sensor

Ultra-small / Cable type **PM-25** SERIES

Compact / Cable type **PM-45** SERIES

Compact / Connector built-in type **PM-65** SERIES

**CE**  
Conforming to  
EMC Directive

**S**  
Certified  
(Some models only)

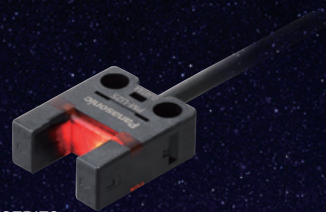

**PM-25** SERIES

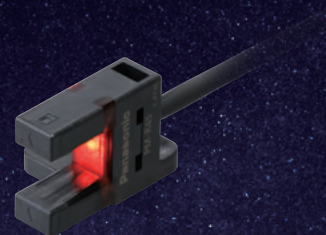

**PM-45** SERIES



**PM-65** SERIES

Ultimate U-shaped micro photoelectric sensors

One Step Ahead in Performance and Mounting Ease

# Industry's First\* and Industry's Top-in-Class\* Advanced Sensors in the Industry.

The Only  
Industry's first

## Three protection circuits standard on all models

PM-25 SERIES PM-45 SERIES PM-65 SERIES

All models are standardly equipped with the following protection circuits in their compact bodies. These protection circuits minimize the possibility of sensor malfunctions caused by erroneous wiring.

- 1 Reverse supply polarity protection circuit
- 2 Reverse output polarity protection circuit
- 3 Output short-circuit protection circuit

The Only  
Industry's first

## Industry's first! IP64 rating

PM-25 SERIES PM-45 SERIES

Our original integrated molding method has eliminated grooves and gaps on the sensing surface and main body, thus reducing the possibility of malfunctions caused by splashing water or dust.

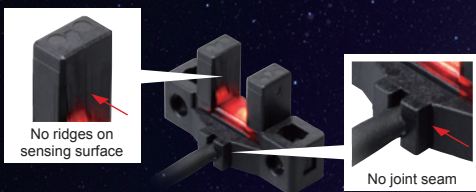

No. 1  
Industry's top-in-class

## Large and easy to see Multi-angle operation indicator

PM-25 SERIES PM-45 SERIES PM-65 SERIES

The large operation indicator (orange) lights up when the beam enters. The indicator is easy to see from above and from the sides.

No. 1  
Industry's top-in-class

## Compact size

PM-45 SERIES

All new models require significantly less mounting space than our conventional models when mounted with the same pitch. What's more, the new models can directly replace our conventional models currently in use.

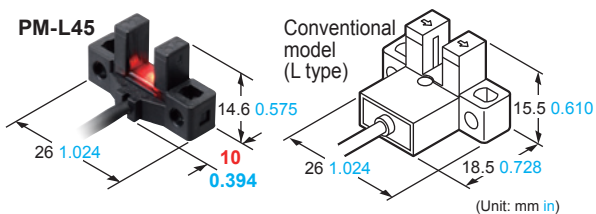

## [Look!] All models easy to mount with M3 screws

PM-25 SERIES PM-45 SERIES PM-65 SERIES

The sensor unit can be installed with one or two M3 screws.

\* M3 screws and washers are not included.

- Models requiring one M3 screw for installation  
PM-F25, PM-R25, PM-F65, PM-R65
- Models requiring two M3 screws for installation  
Models other than above

## Resistant to vibrations and impacts

PM-25 SERIES PM-45 SERIES PM-65 SERIES

The sections where stress concentrates, such as the connecting section of the cable and internal circuit, are covered with a resin. This helps prevent malfunctions caused by vibrations and impacts.

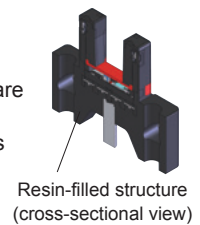

# Translate to the Most

\* As of November 2015, according to our company's survey

The Only  
Industry's first

## Ample beam emitting / receiving distance of 6 mm 0.236 in

PM-25 SERIES PM-45 SERIES PM-65 SERIES

The beam emitting and receiving sections are 0.5 mm 0.02 in thinner than those on our conventional models while their external dimensions are the same. As a result, the distance between the beam emitting point and receiving point increased by 1 mm 0.039 in. The wider distance means less possibility of collision between the sensing section and sensing object.

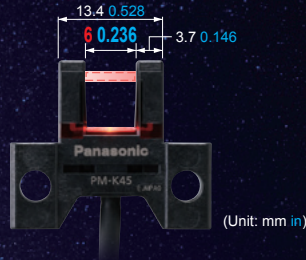

The Only  
Industry's first

## Beam marks for easy adjustment

PM-25 SERIES PM-45 SERIES PM-65 SERIES

The upper-limit and lower-limit positions of beam can be visually confirmed from the front, back, right and left sides of the sensor unit. This allows easy adjustment of the position of sensing object.

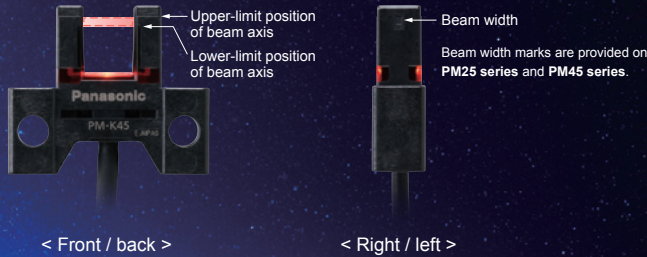

## APPLICATIONS

### Positioning of a pallet

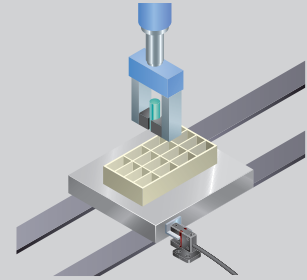

Pallet is stopped by sensing the dog\*.

### Sensing the starting point and overrun of a moving body

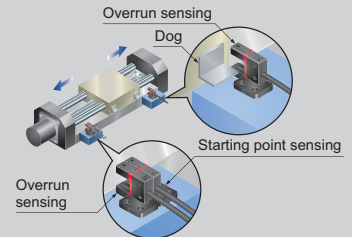

Starting point and overrun is sensed using the dog\* on the base.

### Sensing the starting point on a rotating body

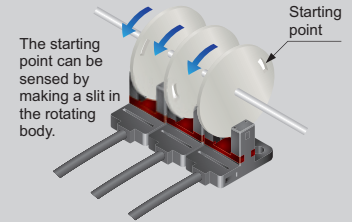

\* "Dog" refers to the sensing object for activating the sensor's detecting operation.

## WIDE VARIATION

Sensors come in various shapes to suit a wide range of mounting conditions

### Ultra-small / Cable type **PM-25 SERIES** Easy mounting with M2 / M3 screws!



### Compact / Cable type **PM-45 SERIES** Compact size!

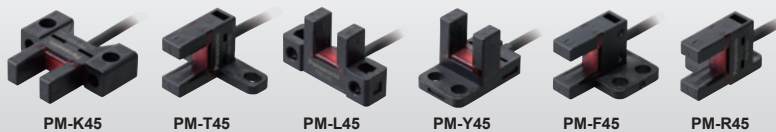





### Compact / Connector built-in type **PM-65 SERIES** Easy connection with a single touch using commercially-available connectors



# Ultra-small / Cable type **PM-25** SERIES

<b>Cable type</b>	<b>NPN output</b>	1 m 3.281 ft cable	3 m 9.843 ft cable	1 m 3.281 ft bending-resistant cable
<b>Built-in connector</b>	<b>PNP output</b>	1 m 3.281 ft cable	3 m 9.843 ft cable	1 m 3.281 ft bending-resistant cable

**Easy mounting with M2 / M3 screws!**

## ORDER GUIDE

Type	Appearance (mm in)	Sensing range	Model No.	Cable length	Output	Output operation
Ultra-small / Cable type	 <p>23.9 0.941, 12.3 0.484, 6 0.236</p>	6 mm 0.236 in (fixed)	PM-K25	1 m 3.281 ft	NPN open-collector transistor	Incorporated with 2 outputs: Light-ON / Dark-ON
			PM-K25-R	1 m 3.281 ft, bending-resistant cable		
			PM-K25-C3	3 m 9.843 ft		
			PM-K25-P	1 m 3.281 ft	PNP open-collector transistor	
	 <p>13.4 0.528, 12 0.472</p>		PM-L25	1 m 3.281 ft	NPN open-collector transistor	
			PM-L25-R	1 m 3.281 ft, bending-resistant cable		
			PM-L25-C3	3 m 9.843 ft		
	 <p>13.4 0.528, 16 0.630, 6 0.236</p>		PM-U25	1 m 3.281 ft	NPN open-collector transistor	
			PM-U25-R	1 m 3.281 ft, bending-resistant cable		
			PM-U25-C3	3 m 9.843 ft		
	 <p>11.7 0.461, 13.4 0.528, 12.5 0.492</p>		PM-F25	1 m 3.281 ft	NPN open-collector transistor	
			PM-F25-R	1 m 3.281 ft, bending-resistant cable		
			PM-F25-C3	3 m 9.843 ft		
	 <p>11.7 0.461, 13.4 0.528, 12.5 0.492</p>		PM-F25-P	1 m 3.281 ft	PNP open-collector transistor	
			PM-R25	1 m 3.281 ft	NPN open-collector transistor	
			PM-R25-R	1 m 3.281 ft, bending-resistant cable		
PM-R25-C3		3 m 9.843 ft				
			PM-R25-P	1 m 3.281 ft	PNP open-collector transistor	

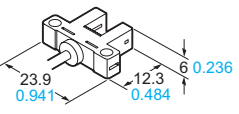
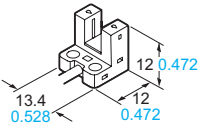
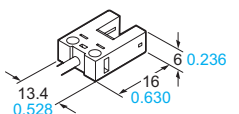
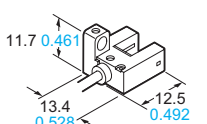
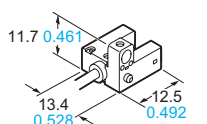
Note: The suffix "-R" in the model No. indicates a bending-resistant cable type. The suffix "-C3" indicates a 3 m 9.843 ft cable length type.

## OPTIONS

Designation	Model No.	Description
Mounting screw	<b>MS-M2</b>	Mounting screw with washers for the ultra-small type sensor (50 pcs. lot). It can mount securely as it is spring washer attached.

### Mounting screw

- MS-M2

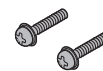

M2 (length 10 mm 0.394 in) screw with a spring washer

## SPECIFICATIONS

Item	Model No.	Type	Ultra-small / Cable type			
				Bending-resistant cable	3 m 9.843 ft cable	
		NPN output	<b>PM-□25</b>	<b>PM-□25-R</b>	<b>PM-□25-C3</b>	
		PNP output	<b>PM-□25-P</b>	_____	_____	
Sensing range		6 mm 0.236 in (fixed)				
Minimum sensing object		0.8 × 1.2 mm 0.031 × 0.047 in opaque object				
Hysteresis		0.05 mm 0.002 in or less				
Repeatability		0.01 mm 0.0004 in or less				
Supply voltage		5 to 24 V DC ±10 % Ripple P-P 10 % or less				
Current consumption		15 mA or less				
Output		<NPN output type> NPN open-collector transistor		<PNP output type> PNP open-collector transistor		
		<ul style="list-style-type: none"> <li>• Maximum sink current: 50 mA</li> <li>• Applied voltage: 30 V DC or less (between output and 0 V)</li> <li>• Residual voltage: 2 V or less (at 50 mA sink current) 1 V or less (at 16 mA sink current)</li> </ul>		<ul style="list-style-type: none"> <li>• Maximum source current: 50 mA</li> <li>• Applied voltage: 30 V DC or less (between output and + V)</li> <li>• Residual voltage: 2 V or less (at 50 mA source current) 1 V or less (at 16 mA source current)</li> </ul>		
		Output operation				Incorporated with 2 outputs: Light-ON / Dark-ON
		Short-circuit protection				Incorporated
Response time		Under light received condition: 20 μs or less Under light interrupted condition: 80 μs or less (Maximum response frequency: 3 kHz) (Note 2)				
Operation indicator		Orange LED (lights up under light received condition)				
Pollution degree		3				
Environmental resistance		Protection				IP64 (IEC)
		Ambient temperature (Note 3, 4)				-25 to +55 °C -13 to +131 °F (No dew condensation or icing allowed), Storage: -30 to +80 °C -22 to +176 °F
		Ambient humidity				5 to 85 % RH, Storage: 5 to 95 % RH
		Ambient illuminance				Fluorescent light: 1,000 lx at the light-receiving face
		Voltage withstandability				1,000 V AC for one min. between all supply terminals connected together and enclosure
		Insulation resistance				20 MΩ, or more, with 250 V DC megger between all supply terminals connected together and enclosure
		Vibration resistance				10 to 2,000 Hz frequency, 1.5 mm 0.059 in double amplitude (maximum acceleration 196 m/s <sup>2</sup> ) in X, Y and Z directions for two hours each
		Shock resistance				15,000 m/s <sup>2</sup> acceleration (1,500 G approx.) in X, Y and Z directions three times each
Emitting element		Infrared LED (Peak emission wavelength: 855 nm 0.034 mil, non-modulated)				
Material		Enclosure: PBT, Display section: Polycarbonate				
Cable		0.09-mm <sup>2</sup> 4-core cabtyre cable, PVC, 1 m 3.281 ft long	0.1-mm <sup>2</sup> 4-core bending-resistant cabtyre cable, PVC, 1 m 3.281 ft long (Note 5, 6)	0.09-mm <sup>2</sup> 4-core cabtyre cable, PVC, 3 m 9.843 ft long		
Cable extension		Extension up to total 100 m 328.084 ft is possible with 0.3 mm <sup>2</sup> , or more, cable. (Note 7)				
Weight		Net weight: 10 g approx., Gross weight: 15 g approx.		Net weight: 30 g approx., Gross weight: 35 g approx.		

Notes: 1) Where measurement conditions have not been specified precisely, the conditions used were an ambient temperature of +23 °C +73.4 °F.

2) The response frequency is the value when the disc, given in the figure below, is rotated.

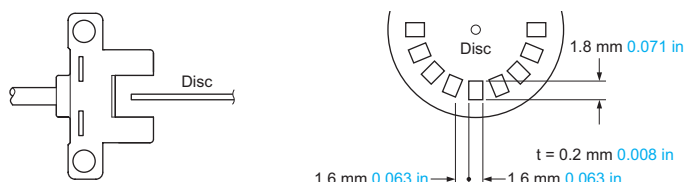

3) In case the **PM-25** series is used at an ambient temperature of +50 °C +122 °F, or more, make sure to mount it on a metal body.

4) Note that the cable of **PM-□25-R** loses its flexibility when the ambient temperature decreases to about -10 °C +14 °F.







5) The cable of **PM-□25-R** is a bending-resistant cable usable on a moving base. When the sensor is mounted on a moving base, secure the sensor cable joint at the unit in place so that stress is not applied to it.

6) When storing **PM-□25-R**, make sure that the cable does not come into contact with the sensing section or operation indicator.

7) If the cable is extended to 20 m 65.617 ft or longer, confirm that the supply voltage at the end of the cable attached to the sensor is 4.5 V or higher.

# Compact / Cable type PM-45 SERIES

<b>Cable type</b>	<b>NPN output</b>	1 m 3.281 ft cable	3 m 9.843 ft cable	1 m 3.281 ft bending-resistant cable
<b>Built-in connector</b>	<b>PNP output</b>	1 m 3.281 ft cable	3 m 9.843 ft cable	1 m 3.281 ft bending-resistant cable

**Compact size!**

## ORDER GUIDE

Type	Appearance (mm in)	Sensing range	Model No.	Cable length	Output	Output operation
Compact / Cable type	 <p>7 0.276 25.4 1.000 21.3 0.839</p>	6 mm 0.236 in (fixed)	PM-K45	1 m 3.281 ft	NPN open-collector transistor	Incorporated with 2 outputs: Light-ON / Dark-ON
			PM-K45-C3	3 m 9.843 ft		
			PM-K45-P	1 m 3.281 ft	PNP open-collector transistor	
			PM-K45-P-C3	3 m 9.843 ft		
	 <p>13.7 0.539 26 1.024 18.1 0.713</p>		PM-T45	1 m 3.281 ft	NPN open-collector transistor	
			PM-T45-C3	3 m 9.843 ft		
			PM-T45-P	1 m 3.281 ft	PNP open-collector transistor	
			PM-T45-P-C3	3 m 9.843 ft		
	 <p>26 1.024 14.6 0.575 7 0.276</p>		PM-L45	1 m 3.281 ft	NPN open-collector transistor	
			PM-L45-C3	3 m 9.843 ft		
			PM-L45-P	1 m 3.281 ft	PNP open-collector transistor	
			PM-L45-P-C3	3 m 9.843 ft		
	 <p>14.6 0.575 13.4 0.528 20.6 0.811</p>		PM-Y45	1 m 3.281 ft	NPN open-collector transistor	
			PM-Y45-C3	3 m 9.843 ft		
			PM-Y45-P	1 m 3.281 ft	PNP open-collector transistor	
			PM-Y45-P-C3	3 m 9.843 ft		
	 <p>13 0.512 13.7 0.539 21.3 0.839</p>		PM-F45	1 m 3.281 ft	NPN open-collector transistor	
			PM-F45-C3	3 m 9.843 ft		
			PM-F45-P	1 m 3.281 ft	PNP open-collector transistor	
			PM-F45-P-C3	3 m 9.843 ft		
 <p>13 0.512 13.7 0.539 21.3 0.839</p>	PM-R45	1 m 3.281 ft	NPN open-collector transistor			
	PM-R45-C3	3 m 9.843 ft				
	PM-R45-P	1 m 3.281 ft	PNP open-collector transistor			
	PM-R45-P-C3	3 m 9.843 ft				

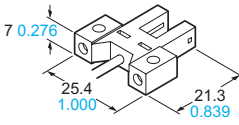
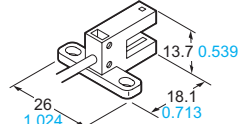
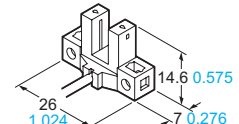
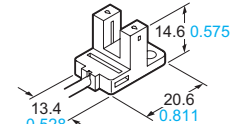
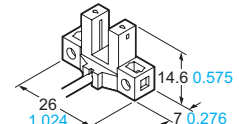
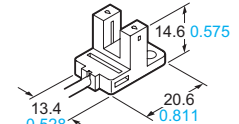
Note: The suffix "-C3" in the model No. indicates a 3 m 9.843 ft cable length type.

## SPECIFICATIONS

Item	Model No.	Type	Compact / Cable type	
				3 m 9.843 ft cable
		NPN output	<b>PM-□45</b>	<b>PM-□45-C3</b>
		PNP output	<b>PM-□45-P</b>	<b>PM-□45-P-C3</b>
Sensing range		6 mm 0.236 in (fixed)		
Minimum sensing object		0.8 × 1.2 mm 0.031 × 0.047 in opaque object		
Hysteresis		0.05 mm 0.002 in or less		
Repeatability		0.01 mm 0.0004 in or less		
Supply voltage		5 to 24 V DC ±10 % Ripple P-P 10 % or less		
Current consumption		15 mA or less		
Output		<NPN output type> NPN open-collector transistor		<PNP output type> PNP open-collector transistor
		<ul style="list-style-type: none"> <li>Maximum sink current: 50 mA</li> <li>Applied voltage: 30 V DC or less (between output and 0 V)</li> <li>Residual voltage: 2 V or less (at 50 mA sink current) 1 V or less (at 16 mA sink current)</li> </ul>		<ul style="list-style-type: none"> <li>Maximum source current: 50 mA</li> <li>Applied voltage: 30 V DC or less (between output and + V)</li> <li>Residual voltage: 2 V or less (at 50 mA source current) 1 V or less (at 16 mA source current)</li> </ul>
		Output operation		Incorporated with 2 outputs: Light-ON / Dark-ON
		Short-circuit protection		Incorporated
Response time		Under light received condition: 20 μs or less Under light interrupted condition: 80 μs or less (Maximum response frequency: 3 kHz) (Note 2)		
Operation indicator		Orange LED (lights up under light received condition)		
Pollution degree		3		
Environmental resistance	Protection		IP64 (IEC)	
	Ambient temperature		-25 to +55 °C -13 to +131 °F (No dew condensation or icing allowed), Storage: -30 to +80 °C -22 to +176 °F	
	Ambient humidity		5 to 85 % RH, Storage: 5 to 95 % RH	
	Ambient illuminance		Fluorescent light: 1,000 lx at the light-receiving face	
	Voltage withstandability		1,000 V AC for one min. between all supply terminals connected together and enclosure	
	Insulation resistance		20 MΩ, or more, with 250 V DC megger between all supply terminals connected together and enclosure	
	Vibration resistance		10 to 2,000 Hz frequency, 1.5 mm 0.059 in double amplitude (maximum acceleration 196 m/s <sup>2</sup> ) in X, Y and Z directions for two hours each	
	Shock resistance		15,000 m/s <sup>2</sup> acceleration (1,500 G approx.) in X, Y and Z directions three times each	
Emitting element		Infrared LED (Peak emission wavelength: 855 nm 0.034 mil, non-modulated)		
Material		Enclosure: PBT, Display section: Polycarbonate		
Cable		0.09-mm <sup>2</sup> 4-core cabtyre cable, PVC, 1 m 3.281 ft long	0.09-mm <sup>2</sup> 4-core cabtyre cable, PVC, 3 m 9.843 ft long	
Cable extension		Extension up to total 100 m 328.084 ft is possible with 0.3 mm <sup>2</sup> , or more, cable. (Note 3)		
Weight		Net weight: 10 g approx., Gross weight: 15 g approx.		Net weight: 30 g approx., Gross weight: 35 g approx.

Notes: 1) Where measurement conditions have not been specified precisely, the conditions used were an ambient temperature of +23 °C +73.4 °F.

2) The response frequency is the value when the disc, given in the figure below, is rotated.

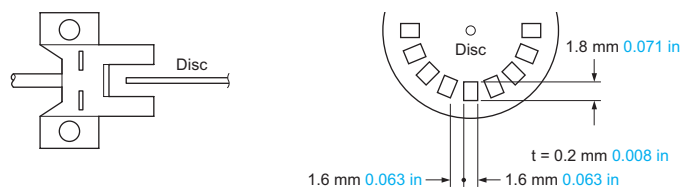

3) If the cable is extended to 20 m 65.617 ft or longer, confirm that the supply voltage at the end of the cable attached to the sensor is 4.5 V or higher.

# Compact / Connector built-in type **PM-65** SERIES

Cable type	NPN output	Connector attached cable 1 m 1.024 in, 2 m 1.640 in, 3 m 2.624 in, 5 m 4.267 in	Connector attached bending-resistant cable 1 m 1.024 in, 2 m 1.640 in, 3 m 2.624 in, 5 m 4.267 in	Easy connection with a single touch using commercially-available connectors				
	PNP output	Connector attached cable 1 m 1.024 in, 2 m 1.640 in, 3 m 2.624 in, 5 m 4.267 in	Connector attached bending-resistant cable 1 m 1.024 in, 2 m 1.640 in, 3 m 2.624 in, 5 m 4.267 in					
Built-in connector								
PM-K65	PM-T65	PM-T65W	PM-L65	PM-Y65	PM-F65	PM-F65W	PM-R65	PM-R65W

## ORDER GUIDE

Type	Appearance (mm in)	Sensing range	Model No.	Output	Output operation	
Compact / Connector built-in type	 26 1.024, 22.4 0.882, 7 0.276	6 mm 0.236 in (fixed)	<b>PM-K65</b>	NPN open-collector transistor	Incorporated with 2 outputs: Light-ON / Dark-ON	
			<b>PM-K65-P</b>	PNP open-collector transistor		
	 26 1.024, 22.4 0.882, 13.7 0.539		<b>PM-T65</b>	NPN open-collector transistor		
			<b>PM-T65-P</b>	PNP open-collector transistor		
			 22.4 0.882, 16.7 0.657, 26 1.024	<b>PM-T65W</b>		NPN open-collector transistor
				<b>PM-T65W-P</b>		PNP open-collector transistor
	 26.2 1.031, 15.7 0.618, 14.9 0.587		<b>PM-L65</b>	NPN open-collector transistor		
			<b>PM-L65-P</b>	PNP open-collector transistor		
	 13.4 0.528, 14.9 0.587, 22.7 0.894		<b>PM-Y65</b>	NPN open-collector transistor		
			<b>PM-Y65-P</b>	PNP open-collector transistor		
	 13.5 0.531, 13.4 0.528, 22.4 0.882		<b>PM-F65</b>	NPN open-collector transistor		
			<b>PM-F65-P</b>	PNP open-collector transistor		
			 13 0.512, 13.4 0.528, 22.4 0.882	<b>PM-F65W</b>		NPN open-collector transistor
				<b>PM-F65W-P</b>		PNP open-collector transistor
	 13.5 0.531, 13.4 0.528, 22.4 0.882		<b>PM-R65</b>	NPN open-collector transistor		
			<b>PM-R65-P</b>	PNP open-collector transistor		
			 13 0.512, 13.4 0.528, 22.4 0.882	<b>PM-R65W</b>		NPN open-collector transistor
				<b>PM-R65W-P</b>		PNP open-collector transistor

Note: "W" in the model No. indicates that the product is mounting-compatible with our conventional models [PM-T53(B) / PM-□64(P)].



OPTIONS

Designation	Model No.	Description	
Connector attached cable	<b>CN-14A-C1</b>	Length: 1m <b>3.281 ft</b>	0.2 mm <sup>2</sup> 4-core cabtyre cable with connector on one end Cable outer diameter: $\varnothing$ 3.7 mm $\varnothing$ 0.146 in
	<b>CN-14A-C2</b>	Length: 2m <b>6.562 ft</b>	
	<b>CN-14A-C3</b>	Length: 3m <b>9.843 ft</b>	
	<b>CN-14A-C5</b>	Length: 5m <b>16.404 ft</b>	
Connector attached cable (Bending-resistant cable)	<b>CN-14A-R-C1</b>	Length: 1m <b>3.281 ft</b>	0.2 mm <sup>2</sup> 4-core cabtyre cable with connector on one end Cable outer diameter: $\varnothing$ 3.7 mm $\varnothing$ 0.146 in
	<b>CN-14A-R-C2</b>	Length: 2m <b>6.562 ft</b>	
	<b>CN-14A-R-C3</b>	Length: 3m <b>9.843 ft</b>	
	<b>CN-14A-R-C5</b>	Length: 5m <b>16.404 ft</b>	
Connector	<b>CN-14A</b>	Set of 10 housings and 40 contacts	

Connector attached cable

- **CN-14A(-R)-C□**

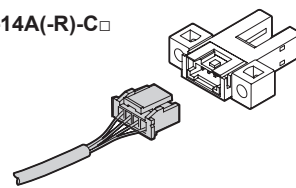

Connector

- **CN-14A**

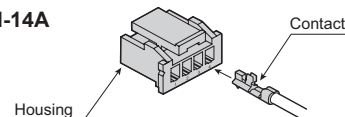

SPECIFICATIONS

Item	Model No.	Type	Compact / Connector built-in type	
				Mounting-compatible with conventional model (Note 2)
		NPN output	<b>PM-□65</b>	<b>PM-□65W</b>
		PNP output	<b>PM-□65-P</b>	<b>PM-□65W-P</b>
Sensing range			6 mm <b>0.236 in</b> (fixed)	
Minimum sensing object			0.8 × 1.2 mm <b>0.031 × 0.047 in</b> opaque object	
Hysteresis			0.05 mm <b>0.002 in</b> or less	
Repeatability			0.01 mm <b>0.0004 in</b> or less	
Supply voltage			5 to 24 V DC $\pm$ 10 % Ripple P-P 10 % or less	
Current consumption			15 mA or less	
Output		<NPN output type> NPN open-collector transistor	<PNP output type> PNP open-collector transistor • Maximum source current: 50 mA • Applied voltage: 30 V DC or less (between output and + V) • Residual voltage: 2 V or less (at 50 mA source current) 1 V or less (at 16 mA source current)	
		• Maximum sink current: 50 mA		
		• Applied voltage: 30 V DC or less (between output and 0 V) • Residual voltage: 2 V or less (at 50 mA sink current) 1 V or less (at 16 mA sink current)		
	Output operation	Incorporated with 2 outputs: Light-ON / Dark-ON		
	Short-circuit protection	Incorporated		
Response time			Under light received condition: 20 $\mu$ s or less, Under light interrupted condition: 80 $\mu$ s or less (Maximum response frequency: 3 kHz) (Note 3)	
Operation indicator			Orange LED (lights up under light received condition)	
Pollution degree			3	
Environmental resistance	Protection		IP40 (IEC)	
	Ambient temperature		-25 to +55 °C <b>-13 to +131 °F</b> (No dew condensation or icing allowed), Storage: -30 to +80 °C <b>-22 to +176 °F</b>	
	Ambient humidity		5 to 85 % RH, Storage: 5 to 95 % RH	
	Ambient illuminance		Fluorescent light: 1,000 lx at the light-receiving face	
	Voltage withstandability		1,000 V AC for one min. between all supply terminals connected together and enclosure	
	Insulation resistance		20 M $\Omega$ , or more, with 250 V DC megger between all supply terminals connected together and enclosure	
	Vibration resistance		10 to 2,000 Hz frequency, 1.5 mm <b>0.059 in</b> double amplitude (maximum acceleration 196 m/s <sup>2</sup> ) in X, Y and Z directions for two hours each	
Shock resistance		15,000 m/s <sup>2</sup> acceleration (1,500 G approx.) in X, Y and Z directions three times each		
Emitting element			Infrared LED (Peak emission wavelength: 855 nm <b>0.034 mil</b> , non-modulated)	
Material			Enclosure: PBT, Display section: Polycarbonate	
Cable length			Extension up to total 100 m <b>328.084 ft</b> is possible with 0.3 mm <sup>2</sup> , or more, cable. (Note 4)	
Weight			Net weight: 3 g approx., Gross weight: 3 g approx.	

- Notes: 1) Where measurement conditions have not been specified precisely, the conditions used were an ambient temperature of +23 °C **+73.4 °F**.  
 2) Mounting-compatible with our conventional models [**PM-T53(B)** / **PM-□64(P)**]  
 3) The response frequency is the value when the disc, given in the figure below, is rotated.

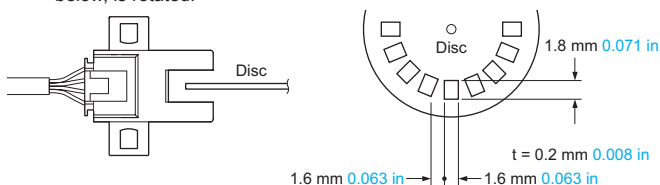

- 4) If the cable is extended to 20 m **65.617 ft** or longer, confirm that the supply voltage at the end of the cable attached to the sensor is 4.5 V or higher.

Recommended connector

Contact: SPHD-001T-P0.5, Housing: PAP-04V-S (Manufactured by J.S.T. Mfg. Co., Ltd.)

Note: Contact the manufacturer for details of the recommended products.

Recommended crimping tool

Model No. : YC-610R (Manufactured by J.S.T. Mfg. Co., Ltd.)

Note: Contact the manufacturer for details of the recommended products.

**I/O CIRCUIT AND WIRING DIAGRAMS**

**NPN output type**

**I/O circuit diagram**

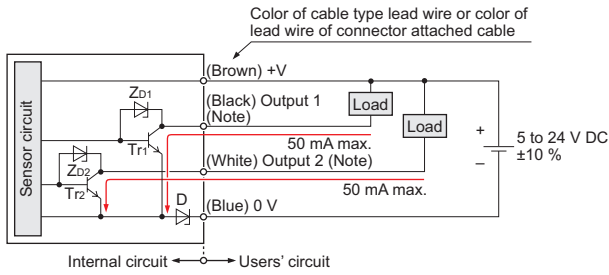

Note: Ensure to insulate the unused output wire.

Symbols...D: Reverse supply polarity protection diode  
 ZD1, ZD2: Surge absorption zener diode  
 Tr1, Tr2: NPN output transistor

**Wiring diagram (PM-25 series / PM-45 series)**

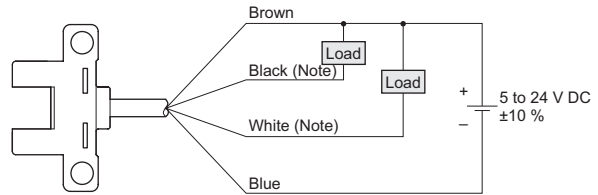

Note: Ensure to insulate the unused output wire.

**Output operation**

	Color code	Output operation
Output 1	Black	Light-ON
Output 2	White	Dark-ON

**Terminal arrangement diagram (PM-65 series)**

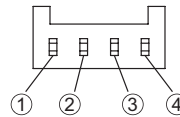

Terminal No.	Designation
①	+V
②	Output 1: Light-ON
③	Output 2: Dark-ON
④	0 V

**PNP output type**

**I/O circuit diagram**

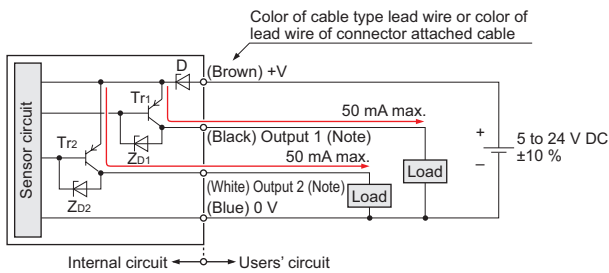

Note: Ensure to insulate the unused output wire.

Symbols...D: Reverse supply polarity protection diode  
 ZD1, ZD2: Surge absorption zener diode  
 Tr1, Tr2: PNP output transistor

**Wiring diagram (PM-25 series / PM-45 series)**

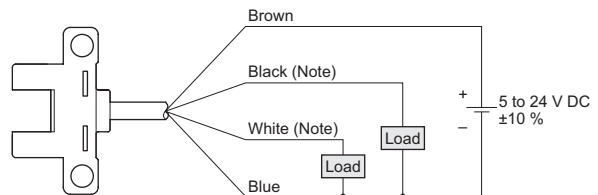

Note: Ensure to insulate the unused output wire.

**Output operation**

	Color code	Output operation
Output 1	Black	Light-ON
Output 2	White	Dark-ON

**Terminal arrangement diagram (PM-65 series)**

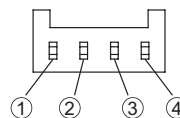

Terminal No.	Designation
①	+V
②	Output 1: Light-ON
③	Output 2: Dark-ON
④	0 V

**SENSING CHARACTERISTICS (TYPICAL)**

**PM-25 series**

**Sensing position**

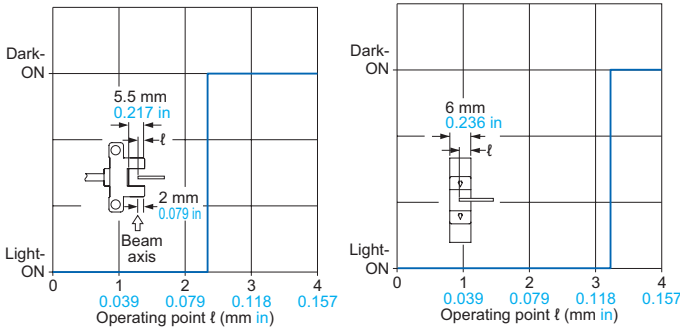

**PM-45 series**

**Sensing position**

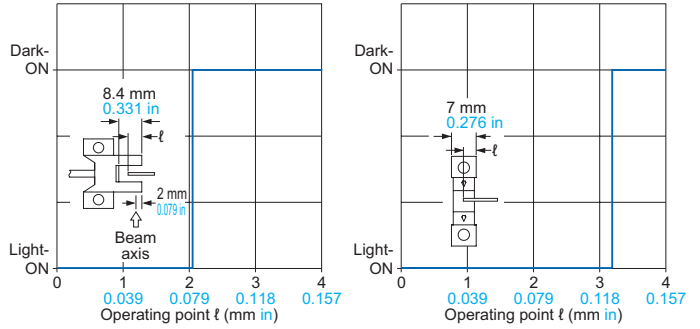

**PM-65 series**

**Sensing position**

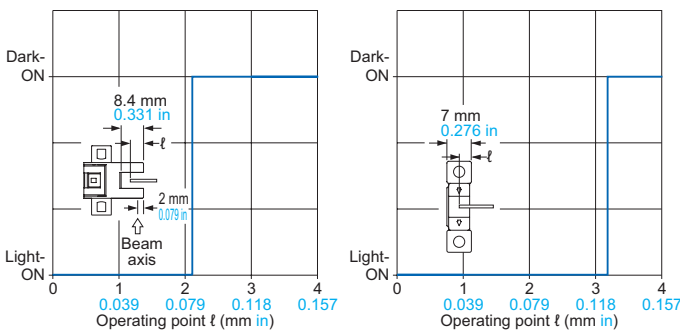

**PRECAUTIONS FOR PROPER USE**



- Never use this product as a sensing device for personnel protection.
- In case of using sensing devices for personnel protection, use products which meet laws and standards, such as OSHA, ANSI or IEC etc., for personnel protection applicable in each region or country.

**Mounting**

**PM-25 series**

- The following conditions must be observed when using screws to mount the sensor unit.

Screw	Spring washer	Flat washer	Tightening torque
M2 screw	1 pc.	ø4.3 mm ø0.169 in (small round washer)	0.15 N·m
M3 screw	1 pc.	ø6 mm ø0.236 in (small round washer)	0.5 N·m

< When using M2 screws for mounting >    < When using M3 screws for mounting >

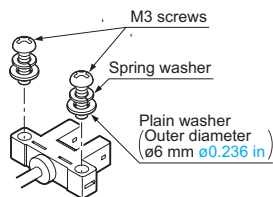
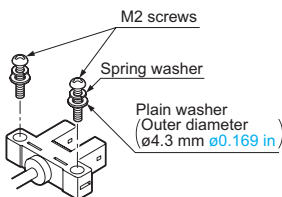

When using the optional mounting screw set **MS-M2**, a spring washer is included.

- In case the **PM-25** series is used at an ambient temperature of +50 °C +122 °F, or more, make sure to mount it on a metal body.

**PM-45 series**

- The following conditions must be observed when using screws to mount the sensor unit.

Screw	Spring washer	Flat washer	Tightening torque
M3 screw	1 pc.	ø6 mm ø0.236 in (small round washer)	0.5 N·m

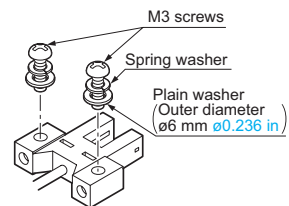

**PM-65 series**

- The following conditions must be observed when using screws to mount the sensor unit.

Screw	Spring washer	Flat washer	Tightening torque
M3 screw	1 pc.	ø6 mm ø0.236 in (small round washer)	0.5 N·m

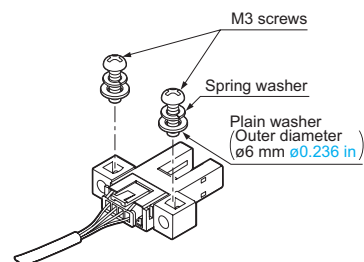

**PRECAUTIONS FOR PROPER USE**

**Cable extension**

**PM-25 series / PM-45 series**

- Cable extension is possible up to an overall length of 100 m **328.084 ft** with a 0.3 mm<sup>2</sup>, or more, cable. However, since a voltage drop shall occur due to the cable extension, ensure that the power supply voltage at the end of the cable attached to the sensor is within the rating.

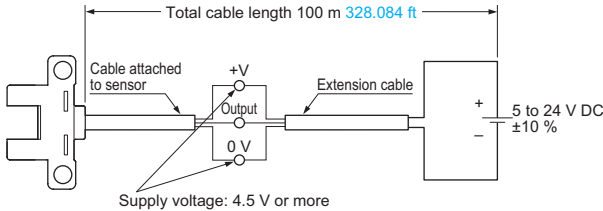

But, when the overall cable length, including the cable attached to the sensor, is as given below, there is no need to confirm the voltage.

Conductor crosssection area of extension cable	Total cable length
0.08 to 0.1 mm <sup>2</sup>	Up to 5 m <b>16.404 ft</b>
0.2 mm <sup>2</sup>	Up to 10 m <b>32.808 ft</b>
0.3 mm <sup>2</sup>	Up to 20 m <b>65.617 ft</b>

**PM-65 series**

- Cable extension is possible up to an overall length of 100 m **328.084 ft** with a 0.3 mm<sup>2</sup>, or more, cable. However, since a voltage drop shall occur due to the cable extension, ensure that the power supply voltage at the end of the connector attached cable of the sensor or at the sensor terminals is within the rating.

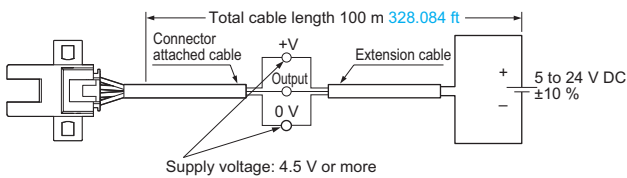

But, when the overall cable length, including the cable attached to the sensor, is as given below, there is no need to confirm the voltage.

Conductor crosssection area of extension cable	Total cable length
0.08 to 0.1 mm <sup>2</sup>	Up to 5 m <b>16.404 ft</b>
0.2 mm <sup>2</sup>	Up to 10 m <b>32.808 ft</b>
0.3 mm <sup>2</sup>	Up to 20 m <b>65.617 ft</b>

**Wiring (PM-65 series)**

**Connection method**

- Insert the connector attached cable **CN-14A-C□** / **CN-14A-R-C□** in the connector part of this product as shown in the figure below.

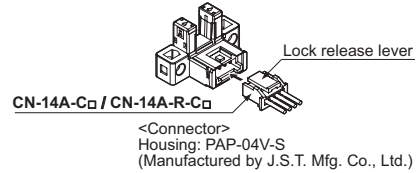

**<Connector pin position>**

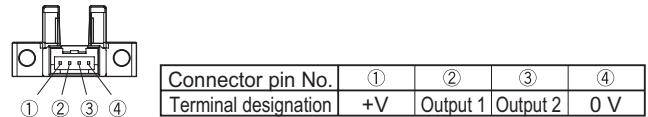

**Disconnection method**

- Press and hold the lock release lever to disconnect the cable connector.

Note: Pulling the cable without pressing the lock release lever in an attempt to disconnect the connector can cause wire breakage in the cable or damage to the connector.

**When using the product as an S-mark compatible product in Korea**

- The power supply cable and output cable connected to the product must be less than 10 m **32.808 ft**.

**Other**

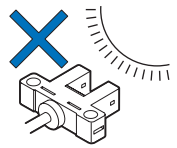
- This device has been developed / produced for industrial use only.
- Since the sensor is intended for use inside machines, no special countermeasures have been taken against extraneous light. Take care that extraneous light is not directly incident on the beam receiving section. 
- Do not use during the initial transient time (50 ms) after the power supply is switched on.
- Note that the cable of **PM-□25-R** loses its flexibility when the ambient temperature decreases to about -10 °C **+14 °F**.
- The cable of **PM-□25-R** is a bending-resistant cable usable on a moving base. When the sensor is mounted on a moving base, secure the sensor cable joint at the unit in place so that stress is not applied to it.
- When storing **PM-□25-R**, make sure that the cable does not come into contact with the sensing section or operation indicator.
- If the sensor is used in a place having excessive dust, periodically clean the emitting and receiving sections with a dry, soft cloth.
- If there is a large surge generating equipment, such as, motor, solenoid, electromagnetic valve, etc., in the vicinity of the sensor, use a surge absorber on that equipment. Further, do not run the sensor cables along power lines and use a capacitor between +V and 0 V, if required. Use the sensor after confirming that the surge has been eliminated.

**DIMENSIONS (Unit: mm in)**

The CAD data can be downloaded from our website.

**PM-K25** Sensor

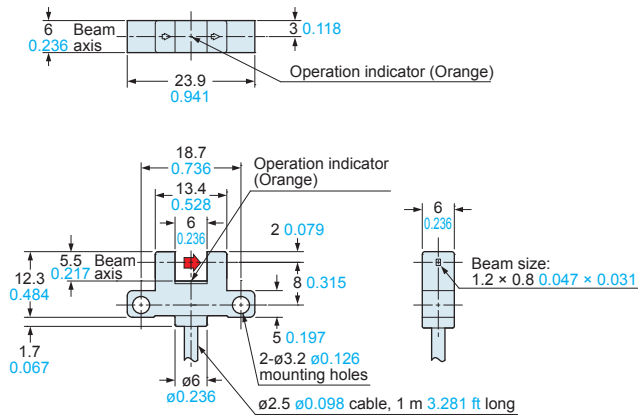

**PM-L25** Sensor

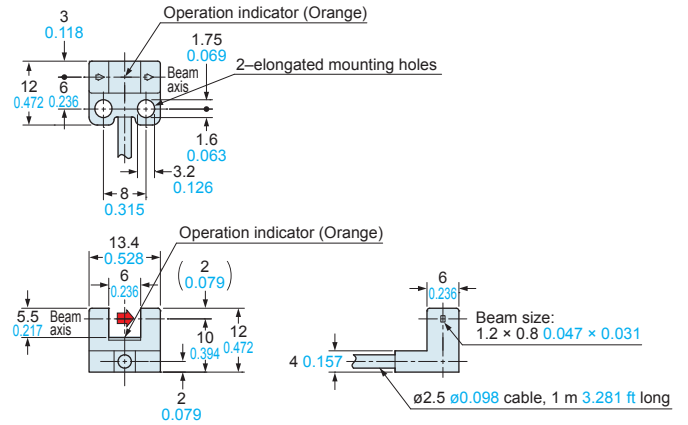

**PM-U25** Sensor

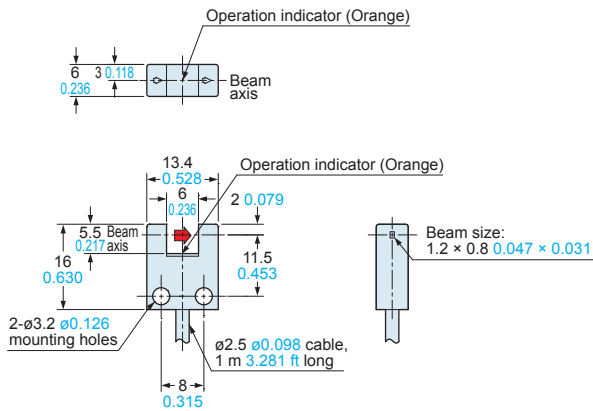

**PM-F25** Sensor

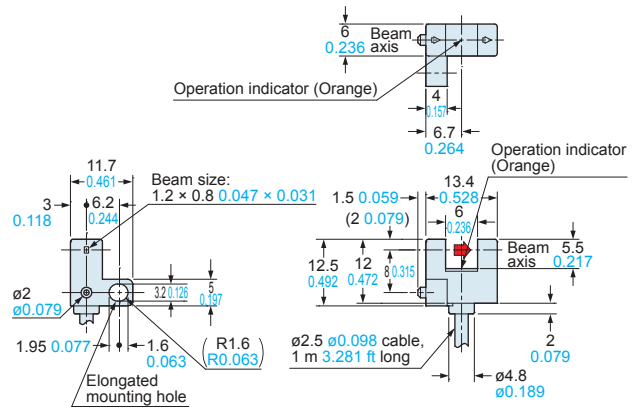

**PM-R25** Sensor

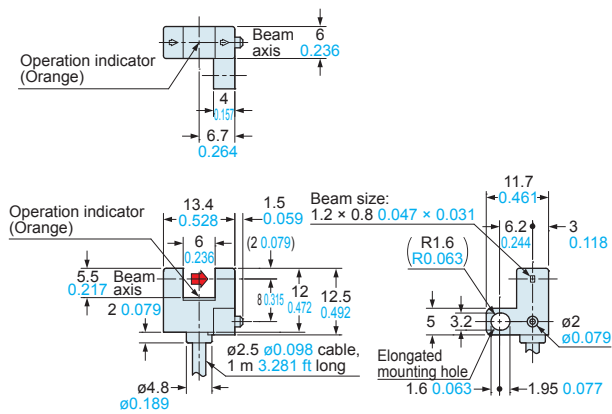

**PM-K45** **Sensor**

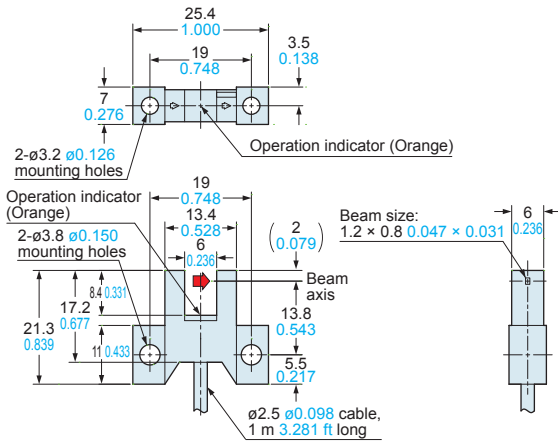

**PM-T45** **Sensor**

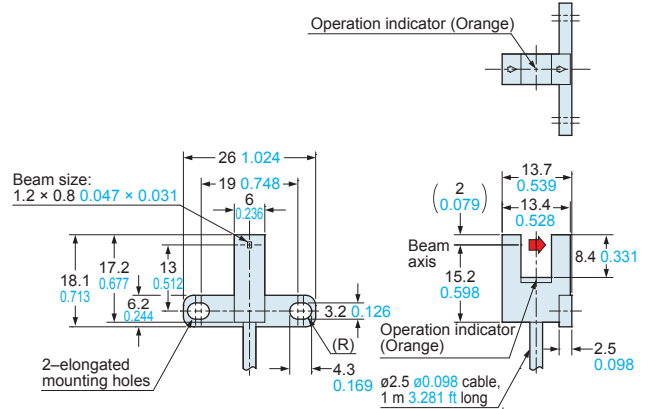

**PM-L45** **Sensor**

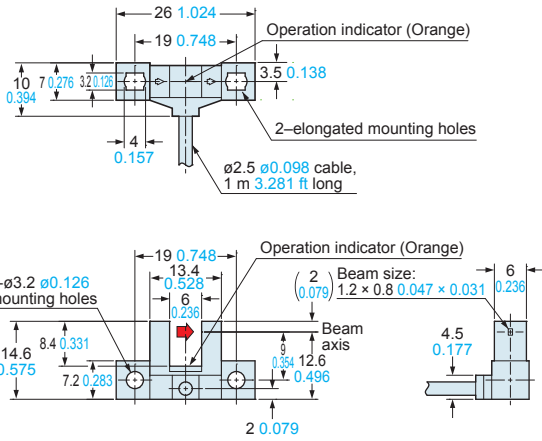

**PM-Y45** **Sensor**

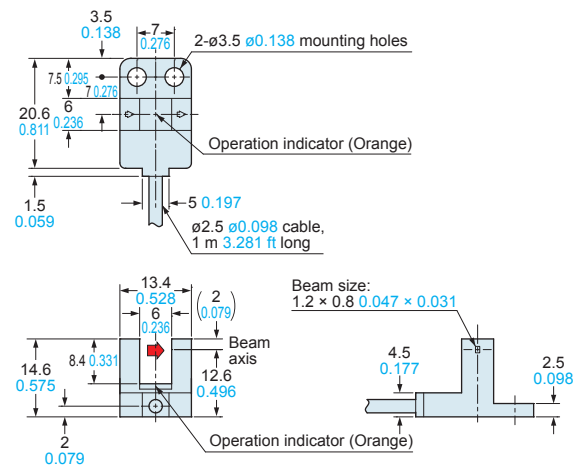

**PM-F45** **Sensor**

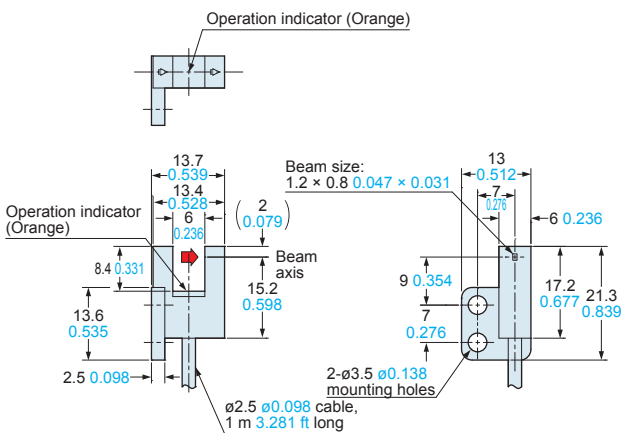

**PM-R45** **Sensor**

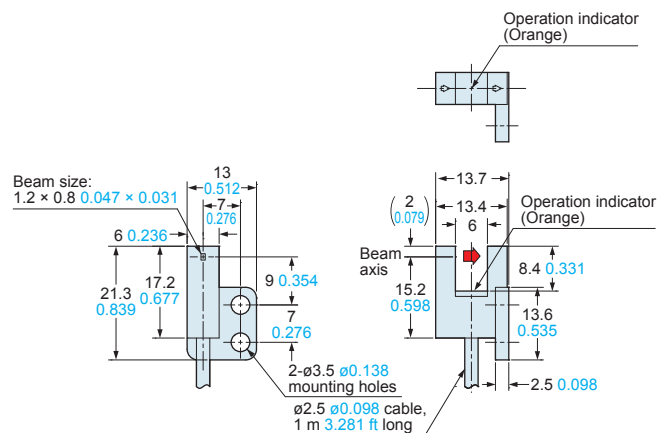

**DIMENSIONS (Unit: mm in)**

The CAD data can be downloaded from our website.

**PM-K65 PM-K65-P** Sensor

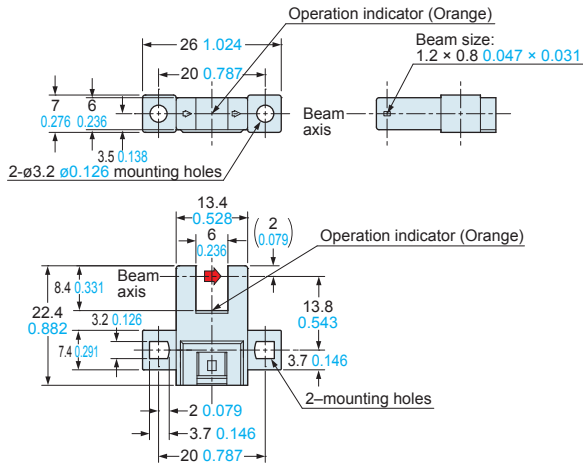

**PM-T65 PM-T65-P** Sensor

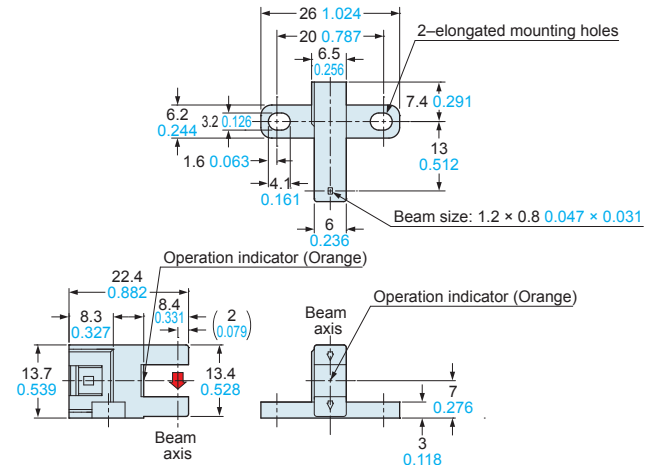

**PM-T65W PM-T65W-P** Sensor

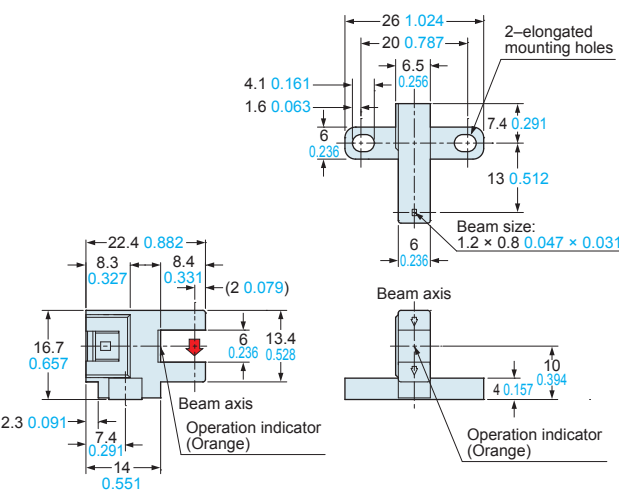

**PM-L65 PM-L65-P** Sensor

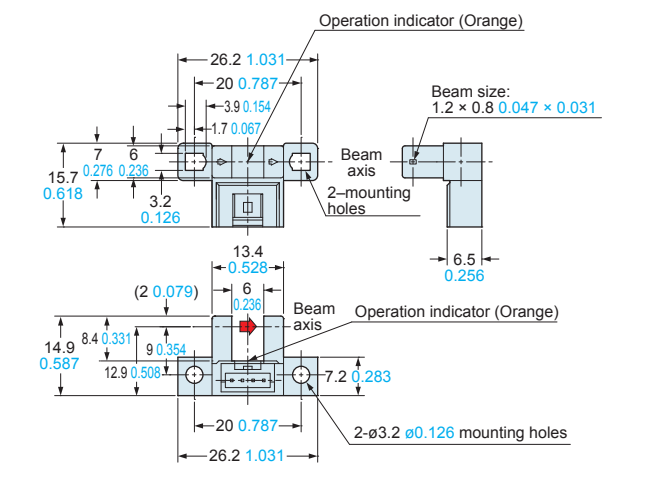

**PM-Y65 PM-Y65-P** Sensor

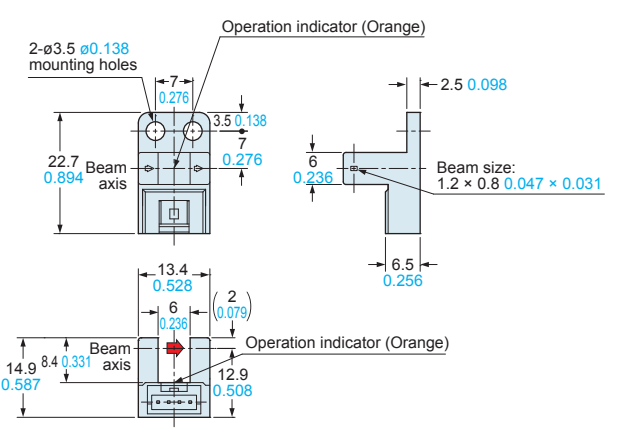

**PM-F65 PM-F65-P** Sensor

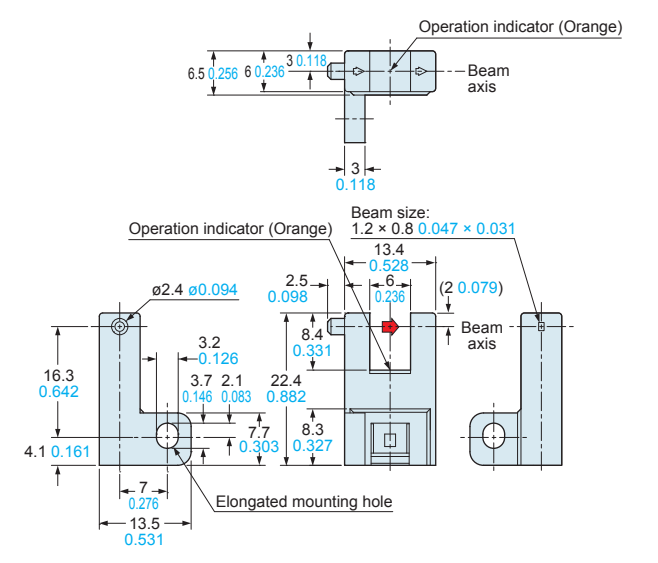

**PM-F65W PM-F65W-P Sensor**

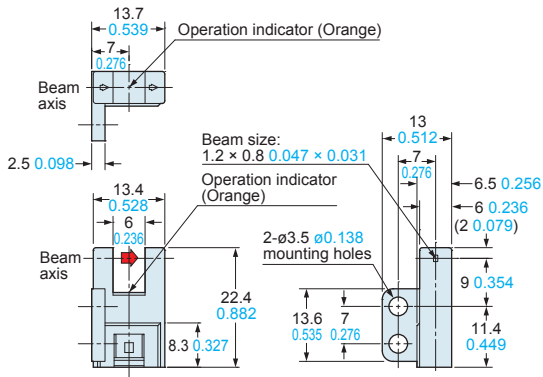

**PM-R65 PM-R65-P Sensor**

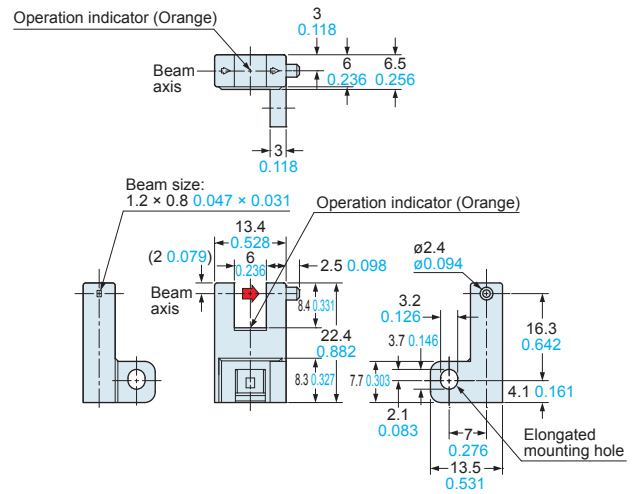

**PM-R65W PM-R65W-P Sensor**

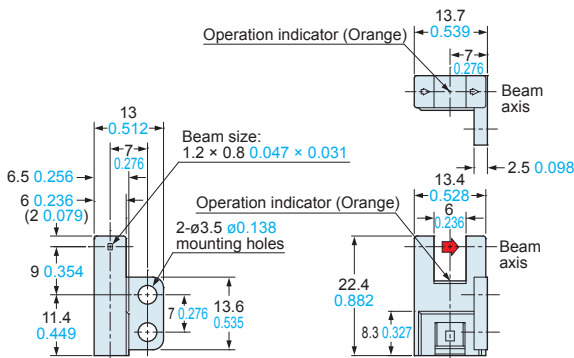

**CN-14A-C□ CN-14A-R-C□ Connector attached cable (Optional)**

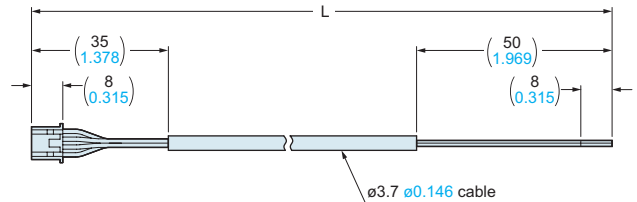

• Length L

Model No.	Length L
<b>CN-14A(-R)-C1</b>	1,000 39.370
<b>CN-14A(-R)-C2</b>	2,000 78.740
<b>CN-14A(-R)-C3</b>	3,000 118.110
<b>CN-14A(-R)-C5</b>	5,000 196.850

**Disclaimer**

The applications described in the catalog are all intended for examples only. The purchase of our products described in the catalog shall not be regarded as granting of a license to use our products in the described applications. We do NOT warrant that we have obtained some intellectual properties, such as patent rights, with respect to such applications, or that the described applications may not infringe any intellectual property rights, such as patent rights, of a third party.

Please contact:

**Panasonic Industrial Devices SUNX Co., Ltd.**

2431-1 Ushiyama-cho, Kasugai-shi, Aichi, 486-0901, Japan  
 Global Sales Department  
 ■Telephone: +81-568-33-7861 ■Facsimile: +81-568-33-8591  
[panasonic.net/id/pidsx/global](http://panasonic.net/id/pidsx/global)





# X-ON Electronics

Largest Supplier of Electrical and Electronic Components

*Click to view similar products for [Panasonic](#) manufacturer:*

Other Similar products are found below :

[ERD-S1TJ8R2V](#) [ERO-S2PHF1502](#) [DP3-22](#) [ECE-A1HKAR47](#) [RP-SMLE04DA1](#) [AH64-05846A](#) [ELL-ATV100M](#) [ERA-14EB121U](#)  
[ECOS1JA122BA](#) [ECW-U1C184JB9](#) [HC2-H-AC48V-F](#) [ERA-S15J471V](#) [ERA-V15J682V](#) [HC4-H-AC24V](#) [HC2-HP-AC115V-F](#) [ECJ-2FF1A475Z](#)  
[ECOS2GP271EA](#) [LC-R063R4P](#) [EYG-A091210P](#) [EEV-HB1HR22R](#) [HC4-H-DC12V](#) [ELC-12D471E](#) [ABS1416509](#) [EVM-3RSX50B13](#) [EEF-](#)  
[SD0E221R](#) [ELL-CTV150M](#) [EET-HC2D102DA](#) [EVM-1USX30B12](#) [EEF-UE0E471LR](#) [PA-LN19](#) [HC2-SF-K](#) [EEF-UE0E471R](#) [ERA-W27J101X](#)  
[ELC-10D330E](#) [ERA-V15J101V](#) [EEV-TG2A220P](#) [HHR-80AAAB3B](#) [036506R](#) [ELL-6RH1R5M](#) [ERD-S1TJ165V](#) [ECE-V0JA220NR](#) [2SB15990QL](#)  
[EVM-3VSX50B52](#) [ECOS2GP121CX](#) [ELJRF22NJFB](#) [EET-HC2S471DA](#) [ECOS1KP392CA](#) [ELJFCR82KF](#) [EEV-HA2A3R3P](#) [EVM-F6SA00B55](#)