

1210 AS

Engineer's Kit : EK-1210AS-X

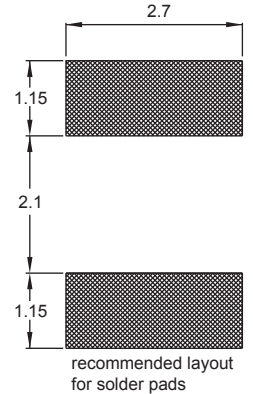

Chip Inductors for RF Applications (Wire wound -open)

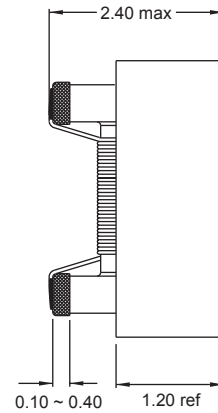
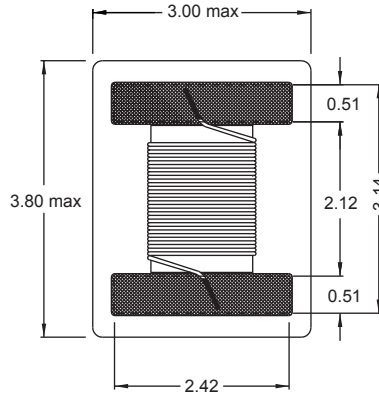
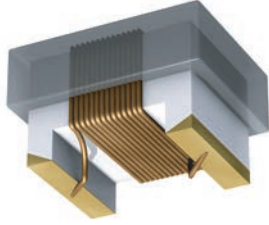
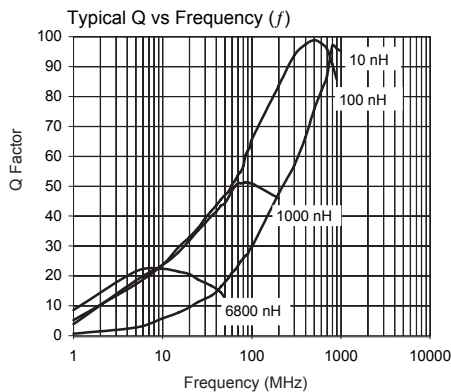
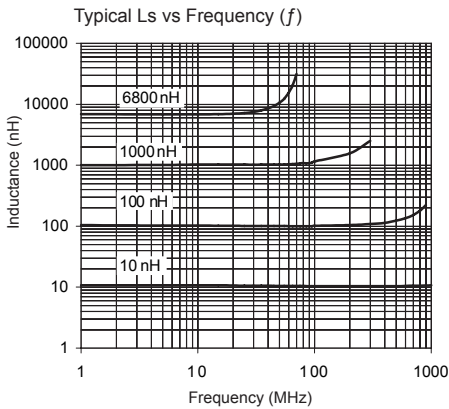
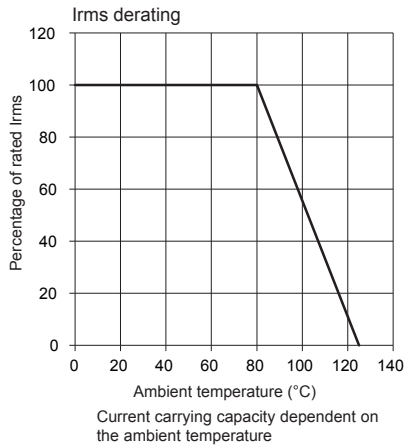

Part No	Inductance L (nH)	f _L (MHz)	Tol ± (%)	Q min	f _Q (MHz)	SRF (MHz)	DCR max (Ω)	Rated DC Current max (mA)
1210AS-010K-YY	10	50	10	50	500	4100 min	0.08	1000
1210AS-012K-YY	12	50	10	50	500	2400 min	0.09	1000
1210AS-015K-YY	15	50	10	50	500	2400 min	0.10	1000
1210AS-018K-YY	18	50	10	50	350	2400 min	0.11	1000
1210AS-022K-YY	22	50	10	55	350	2400 min	0.12	1000
1210AS-027J-YY	27	50	5	55	350	1800 min	0.13	1000
1210AS-033J-YY	33	50	5	60	350	1600 min	0.14	1000
1210AS-039J-YY	39	50	5	60	350	1500 min	0.15	1000
1210AS-047J-YY	47	50	5	65	350	1200 min	0.16	1000
1210AS-056J-YY	56	50	5	65	350	1200 min	0.16	1000
1210AS-068J-YY	68	50	5	65	350	1000 min	0.20	1000
1210AS-082J-YY	82	50	5	60	350	1000 min	0.22	1000
1210AS-R10J-YY	100	25	5	60	350	1000 min	0.24	980
1210AS-R12J-YY	120	25	5	60	350	850 min	0.26	920
1210AS-R15J-YY	150	25	5	50	100	750 min	0.29	870
1210AS-R18J-YY	180	25	5	50	100	700 min	0.31	830
1210AS-R22J-YY	220	25	5	50	100	650 min	0.35	790
1210AS-R27J-YY	270	25	5	45	100	600 min	0.42	730
1210AS-R33J-YY	330	25	5	45	100	500 min	0.49	680
1210AS-R39J-YY	390	25	5	45	100	500 min	0.54	640
1210AS-R47J-YY	470	25	5	45	100	450 min	0.60	610
1210AS-R56J-YY	560	25	5	45	100	415 min	1.00	460
1210AS-R68J-YY	680	25	5	45	100	350 min	1.15	420
1210AS-R82J-YY	820	25	5	45	100	350 min	1.93	350
1210AS-1R0K-YY	1000	25	10	35	50	290 typ	2.16	330
1210AS-1R2K-YY	1200	7.9	10	35	50	250 typ	2.38	310
1210AS-1R5K-YY	1500	7.9	10	25	50	200 typ	2.64	300
* 1210AS-1R8K-YY	1800	7.9	10	25	50	160 typ	2.76	290
* 1210AS-2R2K-YY	2200	7.9	10	25	50	160 typ	2.98	280
* 1210AS-2R7K-YY	2700	7.9	10	25	25	140 typ	3.30	260
* 1210AS-3R3K-YY	3300	7.9	10	25	25	120 typ	3.66	250
* 1210AS-3R9K-YY	3900	7.9	10	20	25	100 typ	4.00	240
* 1210AS-4R7K-YY	4700	7.9	10	20	25	90 typ	4.30	230
* 1210AS-5R6K-YY	5600	7.9	10	15	25	60 typ	4.30	230
* 1210AS-6R8K-YY	6800	7.9	10	15	25	60 typ	5.20	210
* 1210AS-8R2K-YY	8200	7.9	10	17	7.9	45 typ	5.90	168
* 1210AS-100K-YY	10000	7.9	10	17	7.9	38 typ	6.00	160
* 1210AS-150K-YY	15000	7.9	10	15	7.9	20 typ	7.00	120

Material : Ceramic

Revision date : 26 Aug 2013

SPQ : Reel 800 [-01]
3,000 [-04]

Remarks: - For not listed inductance values please check availability with us.
- 2% and 5% tolerance available on request.
- All are AEC-Q200 Standard approved EXCEPT *.

X-ON Electronics

Largest Supplier of Electrical and Electronic Components

Click to view similar products for [Fixed Inductors](#) category:

Click to view products by [Fastron](#) manufacturer:

Other Similar products are found below :

[MLZ1608M6R8WTD25](#) [MLZ1608N6R8LT000](#) [MLZ1608N3R3LTD25](#) [MLZ1608N3R3LT000](#) [MLZ1608N150LT000](#)

[MLZ1608M150WTD25](#) [MLZ1608M3R3WTD25](#) [MLZ1608M3R3WT000](#) [MLZ1608M150WT000](#) [MLZ1608A1R5WT000](#)

[MLZ1608N1R5LT000](#) [B82432C1333K000](#) [PCMB053T-1R0MS](#) [PCMB053T-1R5MS](#) [PCMB104T-1R5MS](#) [CR32NP-100KC](#) [CR32NP-](#)

[151KC](#) [CR32NP-180KC](#) [CR32NP-181KC](#) [CR32NP-1R5MC](#) [CR32NP-390KC](#) [CR32NP-3R9MC](#) [CR32NP-680KC](#) [CR32NP-820KC](#)

[CR32NP-8R2MC](#) [CR43NP-390KC](#) [CR43NP-560KC](#) [CR43NP-680KC](#) [CR54NP-181KC](#) [CR54NP-470LC](#) [CR54NP-820KC](#) [CR54NP-8R5MC](#)

[MGDQ4-00004-P](#) [MGDU1-00016-P](#) [MHL1ECTTP18NJ](#) [MHL1JCTTD12NJ](#) [PE-51506NL](#) [PE-53601NL](#) [PE-53630NL](#) [PE-53824SNLT](#) [PE-](#)

[62892NL](#) [PE-92100NL](#) [PG0434.801NLT](#) [PG0936.113NLT](#) [PM06-2N7](#) [PM06-39NJ](#) [HC2LP-R47-R](#) [HC2-R47-R](#) [HC3-2R2-R](#) [HC8-1R2-R](#)