

## EMR measuring and monitoring relays

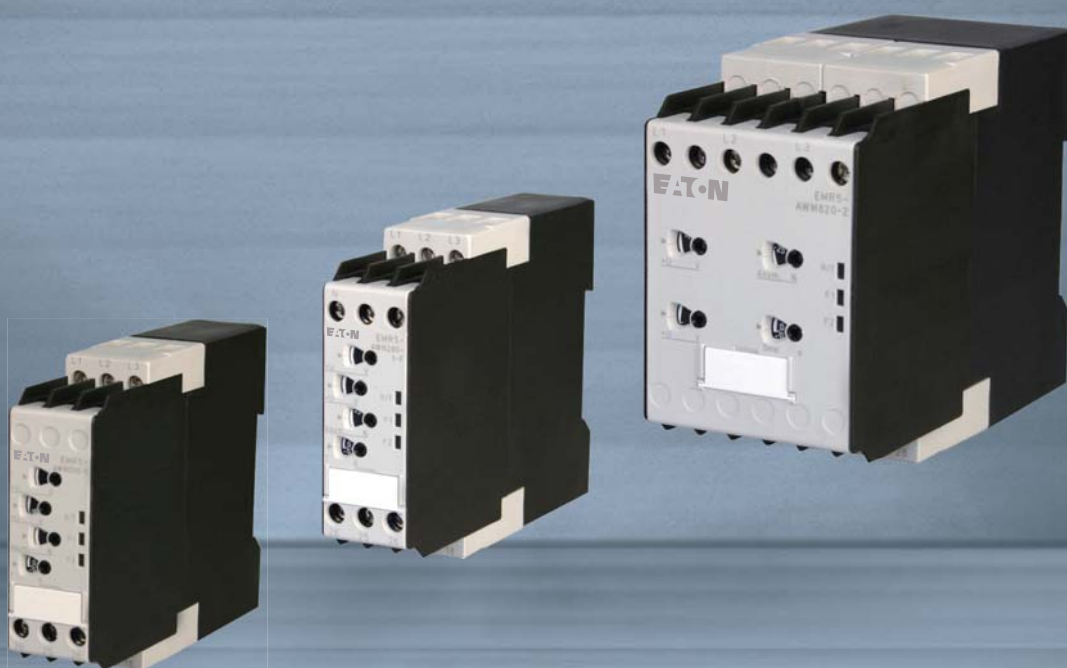

**EATON**

*Powering Business Worldwide*

# EAT•N

## The power of fusion.

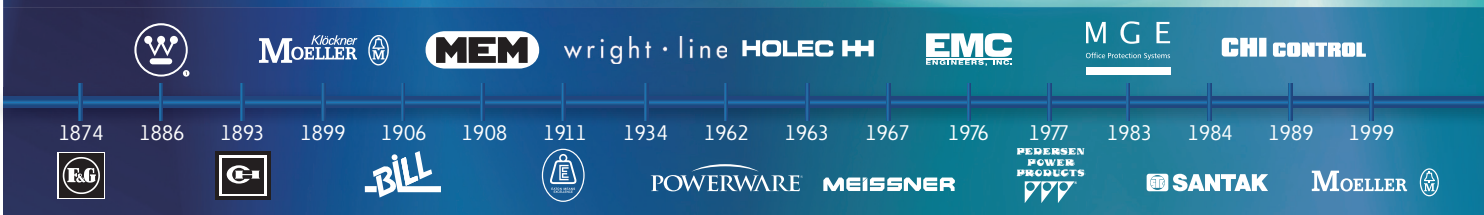

# EAT•N

Powering Business Worldwide

There's a certain energy at Eaton. It's the power of uniting some of the world's most respected names to build a brand you can trust to meet every power management need. The energy created supports our commitment to powering business worldwide.

Eaton is dedicated to ensuring that reliable, efficient and safe power is available when it's needed most. With unparalleled knowledge of electrical power management across industries, experts at Eaton deliver customized, integrated solutions to solve our customers' most critical challenges. [Eaton.com/Electrical](http://Eaton.com/Electrical).

All of the above are trademarks of Eaton Corporation or its affiliates. •Eaton has a license to use the Westinghouse brand name in Asia Pacific. ©2012 Eaton Corporation.

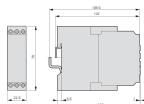
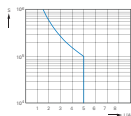

### Ordering

EMR measuring and monitoring relays . . . . . 2

### Engineering

EMR Measuring and monitoring relays  
Load limit curves . . . . . 5

### Technical data

EMR Measuring and monitoring relays  
EMR4-I... current monitoring relay . . . . . 6  
Phase sequence relay EMR5 (300 V) . . . . . 10  
Phase imbalance monitor . . . . . 12  
Liquid level monitoring relays . . . . . 14  
Insulation monitoring relays . . . . . 16  
Phase monitoring relays . . . . . 18

### Dimensions

EMR measuring and monitoring relays . . . . . 22

**Our product range of measurement and monitoring relays has been partially updated.**

Old device	Old article no.	New device	New article no.
EMR4-W500-2-C	221785	EMR5-W500-1-D	134221
EMR4-W500-2-D	221786	EMR5-W500-1-D	134221
EMR4-W580-2-D	221787	EMR5-AWM720-2	134236
EMR4-A400-1	221788	EMR5-A400-1	134222
EMR4-AW300-1-C	290243	EMR5-AW300-1-C	134223
EMR4-AW500-1-D	290244	EMR5-AW500-1-D	134224
EMR4-AWN170-1-E	290245	EMR5-AWN170-1-E	134225
EMR4-AWN280-1-F	290246	EMR5-AWN280-1-F	134226
EMR4-W300-1-C	290182	EMR5-W300-1-C	134227
EMR4-W500-1-D	290183	EMR5-W500-1-D	134221
EMR4-W380-1	290184	EMR5-W380-1	134228
EMR4-W400-1	290185	EMR5-W400-1	134229
EMR4-A300-1-C	290180	EMR5-A300-1-C	134230
EMR4-A500-1-D	290181	EMR5-A400-1	134222

This table provides assistance in replacing EMR4 articles with current EMR5 products.

# Electronic relays

## Measuring and monitoring relays

### Ordering

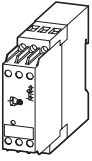

#### Current monitoring relays EMR4-I..., single-phase

	Current measurement range	Contact sequences	Supply voltage connection	Part no. Article no.	Price See price list	Std. pack
	I- / I= A					
Load limit curves → Page 7 Circuit and contact sequence diagrams → Instructional leaflet (AWA) under <a href="http://www.eaton.com">www.eaton.com</a>						
<ul style="list-style-type: none"> <li>Switching hysteresis adjustable from 3 - 30 %</li> <li>Response delay 0.1 - 30 s</li> <li>Monitoring of one upper or lower limit</li> <li>Extension of the measurement range possible with current transformers</li> </ul>	3 - 30 mA 10 - 100 mA 0.1 - 1 A 0.3 - 1.5 A 1 - 5 A 3 - 15 A 0.3 - 1.5 A 1 - 5 A 3 - 15 A		24 - 240 V AC, 50/60 Hz 24 - 240 V DC 24 - 240 V AC, 50/60 Hz 24 - 240 V DC 220 - 240 V AC, 50/60 Hz	<b>EMR4-I1-1-A</b> 106942  <b>EMR4-I15-1-A</b> 106943  <b>EMR4-I15-1-B</b> 106944	1 off   1 off   1 off 	

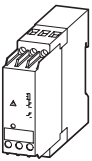

#### EMR4-F... phase sequence relay

	Monitoring voltage per phase	Contact sequences	Supply voltage connection	Part no. Article no.	Price See price list	Std. pack
	$U_N$ V AC					
Load limit curves → Page 7 Circuit and contact sequence diagrams → Instructional leaflet (AWA) under <a href="http://www.eaton.com">www.eaton.com</a>						
<ul style="list-style-type: none"> <li>Monitors three-phase systems for phase sequence and phase failure (<math>&lt; 0.6 \times U_e</math>)</li> <li>Supply voltage connection = monitored voltage</li> </ul>	200 - 500 V AC, 50/60 Hz		200 - 500 V AC, 50/60 Hz	<b>EMR4-F500-2</b> 221784	1 off 	

#### EMR5-A... phase imbalance monitoring relays

	Threshold value	Contact sequences	Supply voltage connection	Part no. Article no.	Price See price list	Std. pack
Load limit curves → Page 7 Circuit and contact sequence diagrams → Instructional leaflet (AWA) under <a href="http://www.eaton.com">www.eaton.com</a>						
Power supply from measuring circuit Three-phase monitoring <ul style="list-style-type: none"> <li>Phase sequence</li> <li>Phase failure</li> <li>Asymmetry</li> <li>Imbalance threshold values adjustable 2 - 25 % of mean value of phase voltages</li> <li>On-delay: None = 0 or adjustable from 0.1 to 30 s</li> </ul>	Imbalance = 2 - 25 % of phase voltage mean value		160 - 300 V AC, 50/60 Hz	<b>EMR5-A300-1-C</b> 134230	1 off 	
Power supply from measuring circuit Three-phase monitoring <ul style="list-style-type: none"> <li>Phase sequence</li> <li>Phase failure</li> <li>Asymmetry</li> <li>Imbalance threshold values adjustable</li> <li>On-delay: None = 0 or adjustable from 0.1 to 30 s</li> </ul>	Imbalance = 2 - 25 % of phase voltage mean value		300 - 500 V AC, 50/60 Hz	<b>EMR5-A400-1</b> 134222	1 off 	

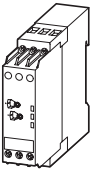
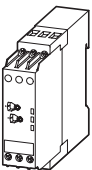

#### Notes

#### Information relevant for export to North America

Product Standards	IEC 255-6; UL 508; CSA-22.2 No. 14-05; CE marking
UL File No.	E29184
UL CCN	NKCR, NKCR7
CSA File No.	UL report valid
CSA Class No.	3211-03
NA Certification	UL Listed, Certified by UL for use in Canada
Degree of Protection	IEC: IP20, UL/CSA Type: -



### Liquid level monitoring relays EMR4-N...

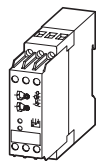

	Response sensitivity	Contact sequences	Supply voltage connection	Part no. Article no.	Price See price list	Std. pack
Load limit curves → Page 7 Circuit and contact sequence diagrams → Instructional leaflet (AWA) under <a href="http://www.eaton.com">www.eaton.com</a>						
<ul style="list-style-type: none"> <li>• Fill level monitoring of conductive liquids</li> <li>• Mixture ratio monitoring of conductive liquids</li> <li>• Selectable dry-running or overflow protection</li> </ul>	5 k $\Omega$ - 100 k $\Omega$		220 - 240 V AC, 50/60 Hz	<b>EMR4-N100-1-B</b> 221789		1 off 

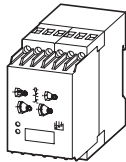

<ul style="list-style-type: none"> <li>• Fill level monitoring of conductive liquids</li> <li>• Mixture ratio monitoring of conductive liquids</li> <li>• Selectable on-delay or off-delay between 0.5 - 10 s</li> </ul>	250 $\Omega$ - 500 k $\Omega$		24 - 240 V AC, 50/60 Hz 24 - 240 V DC	<b>EMR4-N500-2-A</b> 221791		1 off 
	250 $\Omega$ - 500 k $\Omega$		220 - 240 V AC, 50/60 Hz	<b>EMR4-N500-2-B</b> 221790		1 off 

### Liquid level monitoring relays EMR5N...

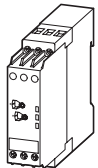

	Response sensitivity	Contact sequences	Supply voltage connection	Part no. Article no.	Price See price list	Std. pack
Load limit curves → Page 7 Circuit and contact sequence diagrams → Instructional leaflet (AWA) under <a href="http://www.eaton.com">www.eaton.com</a>						
<ul style="list-style-type: none"> <li>• Fill level monitoring of conductive liquids</li> <li>• Conductivity (mixture ratio) monitoring of conductive liquids</li> </ul>	5 k $\Omega$ - 100 k $\Omega$		220 - 240 V AC, 50/60 Hz	<b>EMR5-N80-1-B</b> 134232		1 off 

#### Notes

#### Information relevant for export to North America











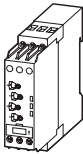
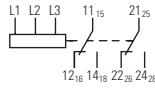



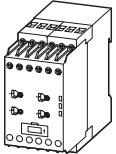

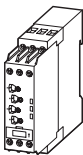
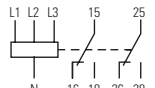

Product Standards	IEC 255-6; UL 508; CSA-22.2 No. 14-05; CE marking
UL File No.	E29184
UL CCN	NKCR, NKCR7
CSA File No.	UL report valid
CSA Class No.	3211-03
NA Certification	UL Listed, Certified by UL for use in Canada
Degree of Protection	IEC: IP20, UL/CSA Type: -

# Electronic relays

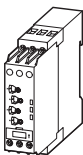

## Measuring and monitoring relays

### Phase monitoring relay EMR5-(A)W...





	Monitoring voltage per phase	Threshold value <sup>1)</sup>	Contact sequences	Supply voltage connection	Width mm	Part no. Article no.	Price See price list	Std. pack
Multifunctional Load limit curves → Page 7 Connections and contact sequence diagrams → Instructional leaflet (AWA) under <a href="http://www.eaton.com">www.eaton.com</a>								
	Power supply from measuring circuit	160 - 300 V AC, 50/60 Hz	U <sub>max</sub> 220 - 300 V AC U <sub>min</sub> 160 - 230 V AC		22.5	<b>EMR5-AW300-1-C</b> 134223		1 off  
	Three-phase monitoring	300 - 500 V AC, 50/60 Hz	U <sub>max</sub> 420 - 500 V AC U <sub>min</sub> 300 - 380 V AC		22.5	<b>EMR5-AW500-1-D</b> 134224		1 off  
	<ul style="list-style-type: none"> <li>Phase sequence</li> <li>Phase failure</li> <li>Overvoltage</li> <li>Undervoltage</li> <li>Asymmetry</li> <li>Adjustable threshold values for overvoltage/undervoltage and imbalance</li> <li>On-/Off-delay: None = 0 or adjustable between 0.1 - 30 s</li> </ul>	350 - 580 V AC, 50/60 Hz	U <sub>max</sub> 480 - 580 V AC U <sub>min</sub> 350 - 460 V AC		45	<b>EMR5-AWM580-2</b> 134235		1 off  
		450 - 720 V AC, 50/60 Hz	U <sub>max</sub> 600 - 720 V AC U <sub>min</sub> 450 - 570 V AC		45	<b>EMR5-AWM720-2</b> 134236		1 off  
		530 - 820 V AC, 50/60 Hz	U <sub>max</sub> 690 - 820 V AC U <sub>min</sub> 530 - 660 V AC		45	<b>EMR5-AWM820-2</b> 134237		1 off
	Power supply from measuring circuit	90 - 170 V AC, 50/60 Hz	U <sub>max</sub> 120 - 170 V AC U <sub>min</sub> 90 - 130 V AC		22.5	<b>EMR5-AWN170-1-E</b> 134225		1 off  
	Three-phase monitoring	180 - 280 V AC, 50/60 Hz	U <sub>max</sub> 240 - 280 V AC U <sub>min</sub> 180 - 220 V AC		22.5	<b>EMR5-AWN280-1</b> 134233		1 off  
	<ul style="list-style-type: none"> <li>Phase sequence</li> <li>Phase failure</li> <li>Overvoltage</li> <li>Undervoltage</li> <li>Asymmetry</li> <li>Neutral cable break (not EMR5-AWN500-1)</li> <li>Adjustable threshold values for overvoltage/undervoltage and imbalance</li> <li>On-/Off-delay: None = 0 or adjustable between 0.1 - 30 s</li> </ul>	180 - 280 V AC, 50/60 Hz	U <sub>max</sub> 240 - 280 V AC U <sub>min</sub> 180 - 220 V AC		22.5	<b>EMR5-AWN280-1-F</b> 134226		1 off  
		300 - 500 V AC, 50/60 Hz	U <sub>max</sub> 420 - 500 V AC U <sub>min</sub> 300 - 380 V AC		22.5	<b>EMR5-AWN500-1</b> 134234		1 off  

**Notes** <sup>1)</sup> Imbalance = 2 - 25% of phase voltage mean value

#### Information relevant for export to North America

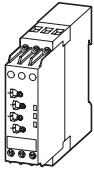
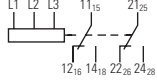
 	Product Standards	IEC 255-6; UL 508; CSA-22.2 No. 14-05; CE marking
	UL File No.	E29184
	UL CCN	NKCR, NKCR7
	CSA File No.	UL report valid
	CSA Class No.	3211-03
	NA Certification	UL Listed, Certified by UL for use in Canada
	Degree of Protection	IEC: IP20, UL/CSA Type: -

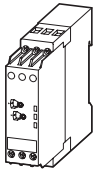
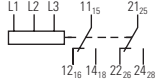
### Phase monitoring relay EMR5-(A)W...

	Monitoring voltage per phase	Threshold value <sup>1)</sup>	Contact sequences	Supply voltage connection	Width mm	Part no. Article no.	Price See price list	Std. pack
On- and Off-delayed Load limit curves → Page 7 Connections and contact sequence diagrams → Instructional leaflet (AWA) under <a href="http://www.eaton.com">www.eaton.com</a>								
	Power supply from measuring circuit	160 - 300 V AC, 50/60 Hz	$U_{max}$ 220 - 300 V AC $U_{min}$ 160 - 230 V AC		160 - 300 V AC, 50/60 Hz	22.5	<b>EMR5-W300-1-C</b> 134227	1 off 
	Three-phase monitoring of phase parameters	300 - 500 V AC, 50/60 Hz	$U_{max}$ 420 - 500 V AC $U_{min}$ 300 - 380 V AC		300 - 500 V AC, 50/60 Hz	22.5	<b>EMR5-W500-1-D</b> 134221	1 off 
	Power supply from measuring circuit	380 V AC, 50/60 Hz	$U_{max}$ 418 V AC $U_{min}$ 342 V AC		380 V, 50/60 Hz	22.5	<b>EMR5-W380-1</b> 134228	1 off 
	Three-phase monitoring of phase parameters	400 V AC, 50/60 Hz	$U_{max}$ 440 V AC $U_{min}$ 360 V AC		400 V, 50/60 Hz	22.5	<b>EMR5-W400-1</b> 134229	1 off 

**Notes** <sup>1)</sup> Imbalance = 2 - 25% of phase voltage mean value





#### Information relevant for export to North America

	
Product Standards	IEC 255-6; UL 508; CSA-22.2 No. 14-05; CE marking
UL File No.	E29184
UL CCN	NKCR, NKCR7
CSA File No.	UL report valid
CSA Class No.	3211-03
NA Certification	UL Listed, Certified by UL for use in Canada
Degree of Protection	IEC: IP20, UL/CSA Type: -

# Electronic relays

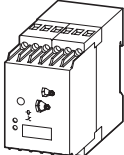
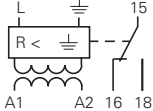
## Measuring and monitoring relays, accessories

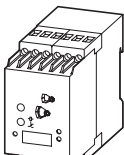
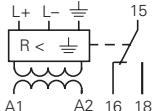
### Insulation monitoring relays EMR4-R...

Description	Insulation resistance range $\Omega$	Contact sequences	Supply voltage connection V AC	Part no. Article no.	Price See price list	Std. pack
 <p>Monitors the insulation resistance between non-grounded AC supply systems and the protective ground conductor Insulation monitoring in 1- and 3-phase AC voltage networks Test via local test button or remote test operation Status display via LED (according to VDE 0413/Part 2) Tripping function memory</p>	1 - 110 k $\Omega$		24 - 240 V AC, 50/60 Hz 24 - 240 V DC	<b>EMR4-RAC-1-A</b> 221793		1 off 
 <p>Monitors the insulation resistance in non-grounded DC supply systems Selector switch for open- or closed-circuit principle Test and reset via local test button or remote test operation Status indication via LEDs</p>	10 - 110 k $\Omega$		24 - 240 V AC, 50/60 Hz 24 - 240 V DC	<b>EMR4-RDC-1-A</b> 221792		1 off 

#### Information relevant for export to North America



Product Standards	IEC 255-6; UL 508; CSA-22.2 No. 14-05; CE marking
UL File No.	E29184
UL CCN	NKCR, NKCR7
CSA File No.	203843
CSA Class No.	3211-03
NA Certification	UL Listed, CSA Certified
Degree of Protection	IEC: IP20, UL/CSA Type: -

### Sealable shroud EMR4-PH...

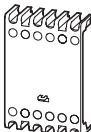
	Width mm	Part no. Article no.	Price See price list	Std. pack
	22.5	<b>EMR4-PH22</b> 221795		1 off
	45	<b>EMR4-PH45</b> 221794		1 off



Engineering

Load limit curves, 22.5 mm range

AC load (resistive)

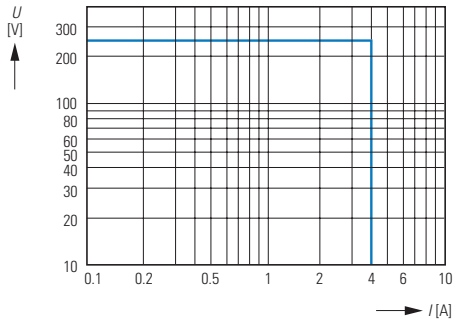

DC load (resistive)

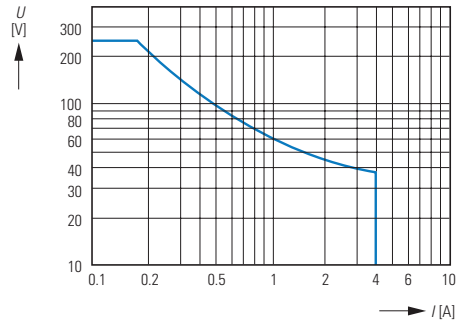

Derating factor with inductive AC load

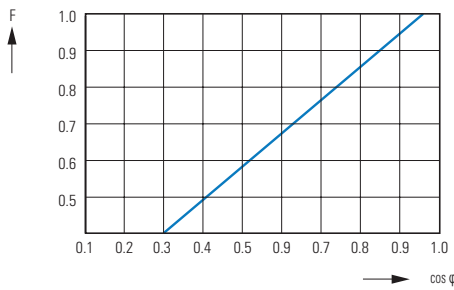

Derating factor F with inductive load

Contact life

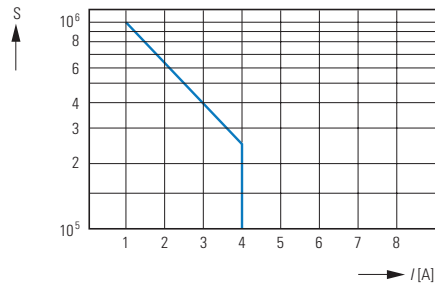

Contact life  
Operations S  
220 V 50 Hz AC-1  
360 operations/h

Load limit curves, 45 mm range

AC load (resistive)

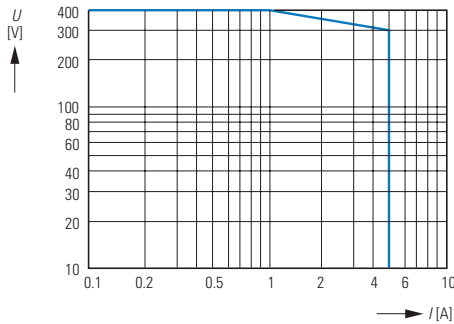

DC load (resistive)

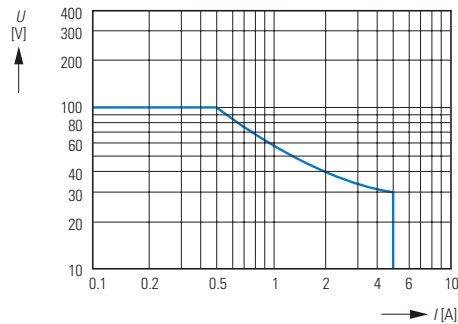

Derating factor with inductive AC load

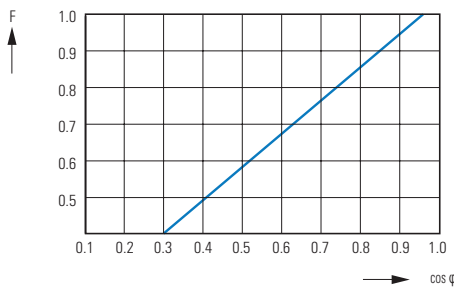

Derating factor F with inductive load

Contact life

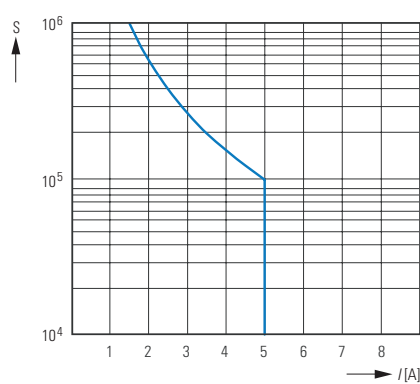

Contact life  
Operations S  
220 V 50 Hz AC-1  
360 operations/h

# Electronic relays

## Measuring and monitoring relays

### Technical data

#### EMR

	EMR4-I11-1-A	EMR4-I15-1-A	EMR4-I15-1-B
<b>Input circuit, power supply circuit A1-A2</b>			
Rated control voltage $U_S$ - power consumption:			
A1-A2	24 - 240 V AC/DC	24 - 240 V AC/DC	220 - 240 V AC
Tolerance of rated control voltage $U_S$	-15 - +10 %	-15 - +10 %	-15 - +10 %
Rated frequency			
AC versions	50/60 Hz	50/60 Hz	50/60 Hz
AC/DC versions	50/60 Hz or DC	50/60 Hz or DC	50/60 Hz or DC
Current/power consumption			
24 V DC	30 mA/0.75 W	30 mA/0.75 W	
115 V AC	24 mA/2.6 VA	24 mA/2.6 VA	
230 V AC	11 mA/2.6 VA	11 mA/2.6 VA	12 mA/2.6 VA
Duty factor (DF)	100 %	100 %	100 %
Mains failure buffering	20 ms	20 ms	20 ms
Transient overvoltage protection	Varistors	Varistors	Varistors
<b>Input circuit measuring circuit B1/B2/B3-C</b>			
Monitoring functions	Overcurrent or undercurrent monitoring can be configured	Overcurrent or undercurrent monitoring can be configured	Overcurrent and undercurrent monitoring
Measurement method	True RMS value measurement, any curve shapes		
Measuring inputs			
Terminal assignment B1 - C	–	–	–
Measurement ranges AC/DC	3 - 30 mA	0.3 - 1.5 A	0.3 - 1.5 A
Input resistance	3.3 $\Omega$	0.05 $\Omega$	0.05 $\Omega$
Pulse overload capacity $t < 1$ s	500 mA	15 A	15 A
Long-term overload	50 mA	2 A	2 A
Measuring inputs			
Terminal assignment B2 - C	–	–	–
Measurement ranges AC/DC	10 - 100 mA	1 - 5 A	1 - 5 A
Input resistance	1 $\Omega$	0.01 $\Omega$	0.01 $\Omega$
Pulse overload capacity $t < 1$ s	1 A	50 A	50 A
Long-term overload	150 mA	7 A	7 A
Measuring inputs			
Terminal assignment B3 - C	0.1 - 1 A	3 - 15 A	3 - 15 A
Measurement ranges AC/DC	0.1 $\Omega$	0.0025 $\Omega$	0.0025 $\Omega$
Input resistance	10 A	100 A	100 A
Pulse overload capacity $t < 1$ s	1.5 A	17 A	17 A
Long-term overload	–	–	–
Threshold value(s)	Adjustable within specified measuring range		
Threshold value setting accuracy	0.1	0.1	0.1
Repetition accuracy (constant parameters)	$\pm 0.07$ % of full-scale value	$\pm 0.07$ % of full-scale value	$\pm 0.07$ % of full-scale value
Hysteresis relative to threshold value	3 - 30 % adjustable	3 - 30 % adjustable	3 - 30 % adjustable
Frequency range of measuring signal	DC/15 Hz - 2 kHz	DC/15 Hz - 2 kHz	DC/15 Hz - 2 kHz
Rated frequency range of measuring signal	DC/50 - 60 Hz	DC/50 - 60 Hz	DC/50 - 60 Hz
Maximum response time	AC: 80 ms/DC: 120 ms	AC: 80 ms/DC: 120 ms	AC: 80 ms/DC: 120 ms
Measuring error within control voltage tolerance	$\leq 0.5$ %	$\leq 0.5$ %	$\leq 0.5$ %
Measuring error within temperature range	$\leq 0.06$ %/°C	$\leq 0.06$ %/°C	$\leq 0.06$ %/°C
<b>Timing circuits</b>			
Release delay $T_V$	0 or 0.1 - 30 s adjustable	0 or 0.1 - 30 s adjustable	0 or 0.1 - 30 s adjustable
Repetition accuracy (constant parameters)	None	$\pm 0.07$ % of full-scale value	$\pm 0.07$ % of full-scale value
Time error within control voltage tolerance	$\leq 0.5$ %	$\leq 0.5$ %	$\leq 0.5$ %
Timeout error within temperature range	$\leq 0.06$ %/°C	$\leq 0.06$ %/°C	$\leq 0.06$ %/°C
<b>Operating status indication</b>			
Control voltage U/T: green LED	Continuous light: control voltage present; slow flashing: trip delay $T_V$ active		
Measured value I: red LED	Continuous light: overcurrent; slow flashing: undercurrent		
Relay status R: yellow LED	Continuous light: relay picked up, no storage Slow flashing: duty factor long: relay picked up, active storage Slow flashing: duty factor short: relay dropped out, active storage		
Output circuits	11(15) - 12(16)/14(18), 21(25) - 22(26)/24(28) - relays	11(15) - 12(16)/14(18), 21(25) - 22(26)/24(28) - relays	11(15) - 12(16)/14(18), 21(25) - 22(26)/24(28) - relays
Output type	Two changeover contacts		
Operating principle	Open-circuit principle: Output relays pick up when actual value exceeds or is below set threshold value.		

EMR

	EMR4-I1-1-A	EMR4-I15-1-A	EMR4-I15-1-B
Contact material	AgNi	AgNi	AgNi
Rated operating voltage (VDE 0110, IEC 947-1)	250 V	250 V	250 V
Minimum switching voltage/minimum switching current	24 V/10 mA	24 V/10 mA	24 V/10 mA
Maximum switching voltage/maximum switching current	250 V AC/4 A AC	250 V AC/4 A AC	250 V AC/4 A AC
Rated operational current (IEC 60947-5-1)			
AC12 (resistive) at 230 V	4 A	4 A	4 A
AC15 (inductive) at 230 V	3 A	3 A	3 A
DC12 (resistive) at 24 V	4 A	4 A	4 A
DC13 (inductive) at 24 V	2 A	2 A	2 A
Rating data AC (UL 508)			
Utilization category (Control Circuit Rating Code)	B 300	B 300	B 300
Max. rated operational voltage	300 V AC	300 V AC	300 V AC
Max. thermal uninterrupted current at B 300	5 A	5 A	5 A
Max. input/output rating (N/O / N/C) for B 300	3600/360 VA	3600/360 VA	3600/360 VA
Mechanical lifespan	30 x 10 <sup>6</sup> operations	30 x 10 <sup>6</sup> operations	30 x 10 <sup>6</sup> operations
Electrical lifespan (AC12, 230 V, 4 A)	0.1 x 10 <sup>6</sup> operations	0.1 x 10 <sup>6</sup> operations	0.1 x 10 <sup>6</sup> operations
Short-circuit strength/maximum fuse rating			
Normally closed contact	6 A fast	10 A fast	10 A fast
Normally open contact	6 A fast	10 A fast	10 A fast
<b>General data</b>			
Enclosure measurements (w x h x d)	22.5 x 78 x 100 mm (0.89 x 3.07 x 3.94 inches)	22.5 x 78 x 100 mm (0.89 x 3.07 x 3.94 inches)	22.5 x 78 x 100 mm (0.89 x 3.07 x 3.94 inches)
Mounting	DIN rail (EN 50022)	DIN rail (EN 50022)	DIN rail (EN 50022)
Mounting position	Any	Any	Any
Degree of protection of enclosures/terminals	IP50/IP20	IP50/IP20	IP50/IP20
<b>Electrical connection</b>			
Terminal capacities			
Flexible with/without ferrule	2 x 0.75 - 2.5 mm <sup>2</sup> (2 x 18 - 14 AWG) With measuring currents > 10 A lateral clearance of 10 mm required		
Rigid	2 x 0.5-4 mm <sup>2</sup> (2 x 20-12 AWG) With measuring currents > 10 A lateral clearance of 10 mm required		
Stripped length	7 mm (0.28 inches)	7 mm (0.28 inches)	7 mm (0.28 inches)
Tightening torque	0.6 - 0.8 Nm	0.6 - 0.8 Nm	0.6 - 0.8 Nm
<b>Environmental data</b>			
Ambient temperature range (operation/storage)	-20 - +60 °C/-40 - +85 °C	-20 - +60 °C/-40 - +85 °C	-20 - +60 °C/-40 - +85 °C
Damp heat (IEC 60068-2-30)	55 °C, 6 cycles	55 °C, 6 cycles	56 °C, 6 cycles
Vibration (sinusoidal) (IEC/EN 60255-21-1)	Class 2	Class 2	Class 2
Impact (IEC/EN 60255-21-2)	Class 2	Class 2	Class 2
<b>Insulation data</b>			
Rated insulation voltage (VDE 0110, IEC 60947-1, IEC/EN 60255-5)			
Power supply/measuring circuit/output	600 V	600 V	600 V
Power supply/output 1/output 2	250 V	250 V	250 V
Rated impulse withstand voltage U <sub>imp</sub> (IEC/EN 60947-1, IEC/EN 60255-5)			
Power supply/measuring circuit/output	6 kV 1.2/50 μs	6 kV 1.2/50 μs	6 kV 1.2/50 μs
Power supply/output 1/output 2	4 kV 1.2/50 μs	4 kV 1.2/50 μs	4 kV 1.2/50 μs
Pollution degree (VDE 0110, IEC 664, IEC/EN 60255-5)	3	3	3
Overvoltage category (VDE 0110, IEC 664, IEC/EN 60255-5)	III	III	III
<b>Directives and standards</b>			
Product standard	IEC/EN 60255-6	IEC/EN 60255-6	IEC/EN 60255-6
Low-Voltage Directive	2006/95/EC	2006/95/EC	2006/95/EC
EMC Directive	2004/108/EC	2004/108/EC	2004/108/EC
<b>Electromagnetic compatibility</b>			
Noise immunity	IEC/EN 61000-6-2	IEC/EN 61000-6-2	IEC/EN 61000-6-2
Electrostatic discharge (ESD) IEC/EN 61000-4-2	Level 3	Level 3	Level 3
Electromagnetic field (immunity to RF interference) IEC/EN 61000-4-3	Level 3	Level 3	Level 3
Fast transients (burst) IEC/EN 61000-4-4	Level 3	Level 3	Level 3
High-energy pulses (surge) IEC/EN 61000-4-9	Level 3	Level 3	Level 3
Cable-borne HF IEC/EN 61000-4-6	Level 3	Level 3	Level 3
Interference emission	IEC/EN 61000-6-3	IEC/EN 61000-6-3	IEC/EN 61000-6-3
Electromagnetic field (immunity to RF interference) IEC/CISPR 22, EN 55022	Class B	Class B	Class B
Cable-borne HF IEC/CISPR 22; EN 55022	Class B	Class B	Class B

# Electronic relays

## Measuring and monitoring relays

### EMR

#### EMR4-F500-2

<b>Input circuit, measuring circuit</b>	
Phase conductor	L1-L2-L3
Rated control voltage $U_S$	3 x 200 - 500 V AC
Power consumption	Approx. 15 VA
Tolerance of rated control voltage $U_S$	-15 - +10 %
Rated frequency	50/60 Hz
Duty factor (DF)	100%
<b>Measuring circuit</b>	
Monitoring functions	
Phase failure	Yes
Phase sequence	Yes
Measuring range	3 x 200 - 500 V AC
Threshold value	0.6 x $U_N$
Frequency of measuring signal	50/60 Hz
Response time	500 ms
Measuring error within rated control voltage tolerance	≤ 0.5 %
Measuring error within temperature range	≤ 0.06 %/°C
<b>Timing circuit</b>	
On-delay $T_S$	Fixed 500 ms
<b>Operating status indication</b>	
Relay status R: yellow LED	Continuous light: output relay picked up
<b>Output circuits</b>	
Output circuits	11(15) -12(16)/14(18), 21(25) -22(26)/24(28)
Output type	Two changeover contacts
Operating principle	Closed-circuit principle: output relays drop out when value exceeds/below set threshold value
Contact material	AgNi
Rated operating voltage (VDE 0110, IEC 60947-1)	250 V
Maximum switching voltage	250 V AC, 250 V DC
Rated operational current (IEC 60947-5-1)	
AC12 (resistive) at 230 V	4 A
AC15 (inductive) at 230 V	3 A
DC12 (resistive) at 24 V	4 A
DC13 (inductive) at 24 V	2 A
Rating data AC (UL 508)	
Utilization category (Control Circuit Rating Code)	B 300
Max. rated operational voltage	300 V AC
Max. thermal uninterrupted current at B 300	5 A
Max. input/output rating (N/O / N/C) for B 300	3600/360 VA
Mechanical lifespan	30 x 10 <sup>6</sup> operations
Electrical lifespan (AC12, 230 V, 4 A)	0.1 x 10 <sup>6</sup> operations
Short-circuit strength/maximum fuse rating	
Normally closed contact	4 A fast
Normally open contact	6 A fast
<b>General data</b>	
Enclosure measurements (w x h x d)	22.5 x 78 x 100 mm (0.89 x 3.07 x 3.94 inches)
Mounting position	Any
Degree of protection of enclosures/terminals	IP50/IP20
Mounting	DIN rail (EN 50022)
<b>Electrical connection</b>	
Terminal capacities	
Flexible with ferrule	2 x 0.75- 2.5 mm <sup>2</sup> (2 x 18 - 14 AWG)
Flexible without ferrule	2 x 0.75- 2.5 mm <sup>2</sup> (2 x 18 - 14 AWG)
Rigid	2 x 0.5 - 4 mm <sup>2</sup> (2 x 20 - 12 AWG)
Stripped length	7 mm (0.28 inches)
Tightening torque	0.6 - 0.8 Nm

EMR

EMR4-F500-2

<b>Environmental data</b>	
Ambient temperature range, operation/storage	-20 - +60 °C / -40 - +85 °C
Climatic testing (IEC 68-2-30)	24 h cycle, 55 °C, 93 % rel., 96 h
Operating safety (IEC 68-2-6)	4 g
Mechanical strength (IEC 68-2-6)	6 g
<b>Insulation data</b>	
Rated voltage between supply, measuring, and output circuits (VDE 0110, IEC 60947-1)	500V
Rated impulse withstand voltage $U_{imp}$ between all insulated circuits (VDE 0110, IEC 664)	2.5 kV, 50 Hz, 1 min.
Test voltage between all insulated circuits (routine test)	4 kV, 50 Hz, 1 min.
Pollution degree (VDE 0110, IEC 664, IEC 255-5)	3
Overvoltage category (VDE 0110, IEC 664, IEC 255-5)	III
<b>Directives and standards</b>	
Product standard	IEC 255-6, EN 60255-6
Low-Voltage Directive	2006/95/EC
EMC Directive	2004/108/EC
<b>Electromagnetic compatibility</b>	
Noise immunity	EN 61000-6-2
Electrostatic discharge (ESD) IEC/EN 61000-4-2	Level 3 (6 kV/8 kV)
Electromagnetic field (immunity to RF interference) IEC/EN 61000-4-3	Level 3 (10 V/m)
Fast transients (burst) IEC/EN 61000-4-4	Level 3 (2 kV/5 kHz)
High-energy pulses (surge) IEC 1000-4-5, EN 61000-4-5	Level 4 (2 kV L-L)
Cable-borne HF IEC 100-4-6, EN 61000-4-6	Level 3 (10 V)
Interference emission	EN 61000-6-4

# Electronic relays

## Measuring and monitoring relays

### EMR

	unit	EMR5-A300-1-C	EMR5-A400-1
<b>Input circuit, measuring circuit</b>			
Rated control voltage, monitored voltage	$U_s$	L1,L2,L3 3 x 160 - 300 V AC	L1,L2,L3 3 x 300 - 500 V AC
Typical current/power consumption		25 mA/10 VA/230 V AC	25 mA/18 VA/400 V AC
Rated control voltage tolerance	$U_s$ %	-15 - +10	-15 - +10
Rated frequency	Hz	50/60	50/60
Frequency range	Hz	45 - 65	45 - 65
<b>Measuring circuit</b>			
Monitoring functions			
Phase failure		Yes	Yes
Phase sequence		Yes	Yes
Automatic phase sequence correction		No	No
Asymmetry		Yes	Yes
Overvoltage/undervoltage		No	No
Neutral conductor		No	No
<b>Measuring range</b>			
Overvoltage		No	No
Undervoltage		No	No
Asymmetry		2 - 25 % of phase voltage mean value	
Adjustable threshold values			
Overvoltage		No	No
Undervoltage		No	No
Imbalance (disconnection value)		Adjustable within measuring range	Adjustable within measuring range
Hysteresis relative to threshold value			
Overvoltage/undervoltage		No	No
Asymmetry		Fixed 20 %	Fixed 20 %
Rated frequency of measuring signal	Hz	50/60	50/60
Frequency range of measuring signal	Hz	45 - 65	45 - 65
Maximum monitoring cycle	ms	100	100
Measuring error within rated control voltage tolerance			
Measuring error within temperature range			
Measurement method		True RMS value measurement	True RMS value measurement
<b>Timing circuit</b>			
On-delay	$T_s$ ms	Fixed 200	Fixed 200
Response delay	$T_v$ s	On-delayed: none = 0; adjustable 0.1 - 30	On-delayed: none = 0; adjustable 0.1 - 30
Timeout error within rated control voltage tolerance	%	$\leq 0.5$	$\leq 0.5$
Timeout error within temperature range	% /°C	$\leq 0.06$	$\leq 0.06$
Repetition accuracy (constant parameters)	%	$< \pm 0.2$	$< \pm 0.2$
<b>Operating status indication</b>			
Relay status R: yellow LED		See instructional leaflet	See instructional leaflet
<b>Output circuits</b>			
Output circuits		15-16/18, 25-26/28	15-16/18, 25-26/28
Output type		2 x 1 relay (changeover contact)	2 x 1 relay (changeover contact)
Operating principle		Closed-circuit principle: output relays drop out when value above/ below set threshold value	
Contact material		AgNi alloy, Cd-free	AgNi alloy, Cd-free
Rated operating voltage (VDE 0110, IEC 60947-1)	V	250	250
Minimum switching voltage/minimum switching current	No	24 V/10 mA	24 V/10 mA
Minimum switching duty	V/mA	24/10	24/10
Maximum switching voltage		→ Page 7	→ Page 7
Rated operational current (IEC 60947-5-1)			
AC12 (resistive) at 230 V	A	4	4
AC15 (inductive) at 230 V	A	3	3
DC12 (resistive) at 24 V	A	4	4
DC13 (inductive) at 24 V	A	2	2
Rating data AC (UL 508)			
Utilization category (Control Circuit Rating Code)		B 300	B 300
Max. rated operational voltage	V AC	300	300
Max. thermal uninterrupted current at B 300	A	5	5
Max. input/output rating (N/O / N/C) for B 300	VA	3600/360	3600/360
Mechanical lifespan	Operations	$30 \times 10^6$	$30 \times 10^6$
Electrical lifespan (AC12, 230 V, 4 A)	Operations	$0.1 \times 10^6$	$0.1 \times 10^6$



## EMR

	unit	EMR5-A300-1-C	EMR5-A400-1
<b>Short-circuit strength/maximum fuse rating</b>			
Normally closed contact		6 A fast	6 A fast
Normally open contact		10 A fast	10 A fast
<b>General data</b>			
Enclosure measurements (w x h x d)	mm (inch)	22.5 x 78 x 100 (0.89 x 3.07 x 3.94)	22.5 x 78 x 100 (0.89 x 3.07 x 3.94)
Mounting position		Any	
Degree of protection of enclosures/terminals		IP50/IP20	
Mounting		DIN rail (EN 60715), clip-type toolless	
<b>Minimum distance to adjacent devices</b>			
Horizontal (min. 10 mm of continuous voltage)	V	> 220	> 400
Vertical		None	None
<b>Electrical connection</b>			
<b>Terminal capacities</b>			
Flexible with ferrule	mm <sup>2</sup> (AWG)	2 x 0.75-2.5 (2 x 18 - 14)	2 x 0.75-2.5 (2 x 18 - 14)
Flexible without ferrule	mm <sup>2</sup> (AWG)	2 x 0.75-2.5 (2 x 18 - 14)	2 x 0.75-2.5 (2 x 18 - 14)
Rigid	mm <sup>2</sup> (AWG)	2 x 0.5-4 (2 x 20 - 12)	2 x 0.5-4 (2 x 20 - 12)
Stripped length	mm (inch)	7 (0.28)	7 (0.28)
Tightening torque	Nm	0.6 - 0.8	0.6 - 0.8
<b>Environmental data</b>			
Ambient temperature range, operation/storage	°C	-25 - +60/-40 - +85	-25 - +60 /-40 - +85
Damp heat (IEC 60068-2-30)		55 °C, 6 cycles	55 °C, 6 cycles
Climate class		3K3	3K3
Vibration (sinusoidal) (IEC/EN 60255-21-1)	Class	2	2
Impact (IEC/EN 60255-21-2)	Class	2	2
<b>Insulation data</b>			
Rated voltage between supply, measuring, and output circuits (VDE 0110, IEC 60947-1)			
Rated impulse withstand voltage U <sub>imp</sub> between all insulated circuits (VDE 0110, IEC 664)			
Rated insulation voltage U <sub>i</sub>			
Input circuit/output circuit	V	600	600
Input circuit 1/output circuit 2	V	300	300
Rated impulse withstand voltage U <sub>imp</sub> (VDE 0110, IEC/EN 60664)			
Input circuit		6 kV; 1.2/50 μs	6 kV; 1.2/50 μs
Output circuits		4 kV; 1.2/50 μs	4 kV; 1.2/50 μs
Test voltage between all insulated circuits (routine test)		2.5 kV, 50 Hz, 1 s	2.5 kV, 50 Hz, 1 s
Basic insulation, input circuit/output circuit	V	600	600
Safe isolation (VDE 0160 Part 101 and 101/A; IEC/EN 61140) input circuit/output circuit		No	No
Pollution degree (VDE 0110, IEC/EN 60664, UL 508)		3	3
Overvoltage category (VDE 0110, IEC 60664, UL 508)		III	III
<b>Directives/Standards</b>			
Product standard		IEC/EN 60255-6, EN 50178	IEC/EN 60255-6, EN 50178
Low-Voltage Directive		2006/95/EC	2006/95/EC
EMC Directive		2004/108/EC	2004/108/EC
RoHS Directive		2002/95/EC	2002/95/EC
<b>Electromagnetic compatibility</b>			
Noise immunity		EN 61000-6-1, EN 61000-6-2	EN 61000-6-1, EN 61000-6-2
Electrostatic discharge (ESD) IEC/EN 61000-4-2	Level	3 (6 kV/8 kV)	3 (6 kV/8 kV)
Electromagnetic field (immunity to RF interference) IEC/EN 61000-4-3	Level	3 (10 V/m)	3 (10 V/m)
Fast transients (burst) IEC/EN 61000-4-4	Level	3 (2 kV/2 kHz)	3 (2 kV/2 kHz)
High-energy pulses (surge) IEC 1000-4-5, EN 61000-4-5	Level	4 (2 kV L-L)	4 (2 kV L-L)
Cable-borne HF IEC 100-4-6, EN 61000-4-6	Level	3 (10 V)	3 (10 V)
Resistance to harmonics EN 61000-4-13	Class	3	3
Interference emission		EN 61000-6-3, EN 61000-6-4	EN 61000-6-3, EN 61000-6-4
Electromagnetic field (immunity to RF interference) IEC/CISPR 22, EN 50022	Class	B	B
Cable-borne HF	Class	B	B

# Electronic relays

## Measuring and monitoring relays

### EMR

	EMR5-N080-1-B	EMR4-N100-1-B	EMR4-N500-2-B	EMR4-N500-2-A
<b>Input circuit</b>				
Rated control voltage				
U <sub>S</sub> - power consumption:				
A1 - A2	220 - 240 V AC approx. 1.5 VA	220 - 240 V AC approx. 4 VA	220 - 240 V AC approx. 3 VA	24 - 240 V AC/DC approx. 2 VA/W
Tolerance of rated control voltage U <sub>S</sub>	-15 % - 10 %	-15 % - 10 %	-15 % - +10 %	-15 % - +10 %
Rated frequency	50 - 60 Hz	50 - 60 Hz	50 - 60 Hz or DC	50 - 60 Hz or DC
Duty factor (DF)	100 %	100 %	100 %	100 %
<b>Measuring circuit</b>				
Monitoring functions	MAX-MIN-C	MAX-MIN-C	MAX-MIN-C	MAX-MIN-C
Response sensitivity	Level control	Level control	Level control	Level control
Response sensitivity	5 - 100 kΩ, adjustable	5 - 100 kΩ, adjustable	250 Ω - 5 kΩ, adjustable	250 Ω - 5 kΩ, adjustable
Maximum electrode voltage	30 V AC	30 V AC	20 V AC	20 V AC
Maximum electrode current	1 mA	1 mA	8 mA	8 mA
<b>Electrode supply cable</b>				
Cable capacity max.	10 nF	10 nF	200 nF	200 nF
Cable length max.	100 m	100 m	1000 m	1000 m
Response sensitivity			2.5-50 kΩ, adjustable	2.5-50 kΩ, adjustable
Maximum electrode voltage			20 V AC	20 V AC
Maximum electrode current			2 mA	2 mA
<b>Electrode supply cable</b>				
Cable capacity max.			20 nF	20 nF
Cable length max.			100 m	100 m
Response sensitivity			25 - 500 kΩ, adjustable	25 - 500 kΩ, adjustable
Maximum electrode voltage			20 V AC	20 V AC
Maximum electrode current			0.5 mA	0.5 mA
<b>Timing circuit</b>				
Release delay	Approx. 250 ms	Approx. 250 ms		
Delay time			0.1 - 10 s, adjustable, on-delay without off-delay	0.1 - 10 s, adjustable, on-delay without off-delay
<b>Operating status indication</b>				
Control voltage	U: green LED	U: green LED	U: green LED	U: green LED
Output relay energized	R MAX/MIN: yellow LED			
Alarm relay AL1	–	R AL1: yellow LED	U: green LED	U: green LED
Alarm relay AL2	–	R AL2: yellow LED	R: yellow LED	R: yellow LED
<b>Output circuits</b>				
Output circuits	11-12/14, 21-22, 31-32	11-12/14, 21-22, 31-32	15-16/18, 25-26/28	15-16/18, 25-26/28
Output type	1 changeover contact, 1 normally closed contact + 1 normally open contact	1 changeover contact, 1 normally closed contact + 1 normally open contact	Two changeover contacts	Two changeover contacts
Operating principle	Live current principle <sup>1)</sup>	Open <sup>-1)</sup> and closed-circuit principle <sup>2)</sup>	Live current principle <sup>1)</sup>	Live current principle <sup>1)</sup>
Contact material	AgCdO	AgCdO	AgCdO	AgCdO
Rated voltage (VDE 0110, IEC 60947-1)	250 V	250 V	400 V	400 V
Maximum switching voltage	250 V	250 V	400 V	400 V
Rated operational current (IEC 60947-5-1)				
AC12 (resistive) 230 V	4 A	4 A	5 A	5 A
AC15 (inductive) 230 V	3 A	3 A	3 A	3 A
DC12 (resistive) 24 V	4 A	4 A	5 A	5 A
DC13 (inductive) 24 V	2 A	2 A	2 A	2 A

### Notes

<sup>1)</sup> Output relays pick up when value above/below set threshold value

<sup>2)</sup> Output relays drop out when value above/below set threshold value

## EMR

	EMR5-N080-1-B	EMR4-N100-1-B	EMR4-N500-2-B	EMR4-N500-2-A
<b>Rated operational data AC (UL 508)</b>				
Utilization category (Control Circuit Rating Code)	B 300	B 300	B 300	B 300
Max. rated operational voltage	300 V AC		300 V AC	300 V AC
Max. thermal uninterupted current at B 300	5 A	5 A	5A	5A
Max. input/output rating (N/O / N/C) for B 300	3600/360 VA	3600/360 VA	3600/360 VA	3600/360 VA
Mechanical lifespan	30 x 10 <sup>6</sup> operations	30 x 10 <sup>6</sup> operations	30 x 10 <sup>6</sup> operations	30 x 10 <sup>6</sup> operations
Electrical lifespan (AC12, 230 V, 4 A)	0.3 x 10 <sup>6</sup> operations	0.3 x 10 <sup>6</sup> operations	0.1 x 10 <sup>6</sup> operations	0.1 x 10 <sup>6</sup> operations
Short-circuit rating, max. fuse rating, N/C / N/O contact	10 A fast/10 A fast	10 A fast/10 A fast	4 A fast/6 A fast	4 A fast/6 A fast
<b>General data</b>				
Enclosure measurements (w x h x d)	22.5 x 70 x 100 mm (0.89 x 3.07 x 3.94 in)	22.5 x 70 x 100 mm (0.89 x 3.07 x 3.94 in)	45 x 78 x 100 mm (1.77 x 3.07 x 3.94 in)	45 x 78 x 100 mm (1.77 x 3.07 x 3.94 in)
Mounting position	Any	Any	Any	Any
Degree of protection of enclosures/terminals	IP50/IP20	IP50/IP20	IP50/IP20	IP50/IP20
Ambient temperature range, operation/storage	-20 - +60 °C / -40 - +85 °C	-20 - +60 °C / -40 - +85 °C	-25 - +65°C / -40 - 85°C	-25 - +65°C / -40 - 85°C
Mounting	DIN rail (EN 50022)	DIN rail (EN 50022)	DIN rail (EN 50022)	DIN rail (EN 50022)
<b>Electrical connection</b>				
Terminal capacity				
Flexible with ferrule	2 x 2.5 mm <sup>2</sup> (2 x 14 AWG)	2 x 2.5 mm <sup>2</sup> (2 x 14 AWG)	2 x 2.5 mm <sup>2</sup> (2 x 14 AWG)	2 x 2.5 mm <sup>2</sup> (2 x 14 AWG)
<b>Directives and standards</b>				
Product standard	IEC 255 - 6, EN 60255-6	IEC 255 - 6, EN 60255-6	IEC 255-6, EN 60255-6	IEC 255-6, EN 60255-6
Low-Voltage Directive	2006/95/EC	2006/95/EC	2006/95/EC	2006/95/EC
EMC Directive	2004/108/EC	2004/108/EC	2004/108/EC	2004/108/EC
Electromagnetic compatibility (EMC)	No	No	No	No
Electrostatic discharge (ESD) IEC/EN 61000-4-2	Level 3 (6 kV/8 kV)	Level 3 (6 kV/8 kV)	Level 3 (6 kV/8kV)	Level 3 (6 kV/8kV)
Electromagnetic field (immunity to RF interference) IEC/EN 61000-4-3	Level 3 (10 V/m)	Level 3 (10 V/m)	Level 3 (10 V/m)	Level 3 (10 V/m)
Fast transients (burst) IEC/EN 61000-4-4	Level 3 (2 kV/5 kHz)	Level 3 (2 kV/5 kHz)	Level 3 (2 kV/5 kHz)	Level 3 (2 kV/5 kHz)
High-energy pulses (surge) IEC1000-4-5, EN 61000-4-5	Level 4 (2 kV L-L)	Level 4 (2 kV L-L)	Level 4 (2 kV L-L)	Level 4 (2 kV L-L)
Immunity to line-conducted interference, IEC 1000-4-6, IEC 1000-4-6, EN 61000-4-6	Level 3 (10 V)	Level 3 (10 V)	Level 3 (10 V)	Level 3 (10 V)
Operating safety (IEC 68-2-6)	4 g	4 g	5 g	5 g
Mechanical strength (IEC 68-2-6)	6 g	6 g	10 g	10 g
<b>Insulation data</b>				
Rated voltage between supply, measuring, and output circuits (VDE 0110, IEC 60947-1)	250 V	250 V	500 V	500 V
Rated impulse withstand voltage between all insulated circuits(VDE 0110, IEC 664)	4 kV/1.2 - 50 μs	4 kV / 1.2 - 50 μs	4 kV/1.2 - 50 μs	4 kV/1.2 - 50 μs
Test voltage between all insulated circuits	2.5 kV, 50 Hz, 1 min.	2.5 kV, 50 Hz, 1 min.	2.5 kV, 50 Hz, 1 min.	2.5 kV, 50 Hz, 1 min.
Pollution degree (VDE 0110, IEC 664, IEC 255-5)	3/C	3/C	3/C	3/C
Overvoltage category (VDE 0110, IEC 664, IEC 255-5)	III/C	III/C	III/C	III/C
Climatic testing (IEC 68-2-30)	24 h cycle, 55 °C, 93 % rel., 96 h	24 h cycle, 55 °C, 93 % rel., 96 h	24 h cycle, 55 °C, 93 % rel., 96 h	24 h cycle, 55 °C, 93 % rel., 96 h

# Electronic relays

## Measuring and monitoring relays

### EMR

	EMR4-RDC-1-A	EMR4-RAC-1-A
<b>Input circuit</b>		
Rated control voltage $U_S$ power consumption:		
A1-B2	24 - 240 V AC/DC - approx. 8 VA / 2 W	24 - 240 V AC/DC - approx. 8 VA / 2 W
Tolerance of rated control voltage $U_S$	-15 % - +10 %	-15 % - +10 %
Rated frequency		
AC/DC versions	15 - 400 Hz or DC	15 - 400 Hz or DC
AC versions	–	50 - 60 Hz
Duty factor (DF)	100 %	100 %
<b>Measuring circuit L-PE</b>		
Monitoring function, insulation monitoring for isolated AC networks	Isolated DC networks	
Measuring range, threshold value setting range min-max.	10 - 110 k $\Omega$	1 - 11 k $\Omega$ , 10 - 110 k $\Omega$
Minimum internal resistance	–	57 k $\Omega$
Minimum internal AC resistance	–	100 k $\Omega$
Internal DC resistance	–	100 k $\Omega$
Test resistance	–	820
Max. voltage at measuring input	300 V DC	415 V AC
Max. DC measuring voltage	24 - 240 V DC	30 V DC
Max. cable length for clear-test button		10 m
Time delay	< 1 s with insulation, < 0.9 x response value	Proportional to insulation resistance and dependent on set threshold value
<b>Operating status indication</b>		
Control voltage	U: green LED	U: green LED
Insulation fault	L+: red LED, L-: red LED	F: red LED
<b>Output circuits</b>		
Output circuits	15-16/18	15-16/18
Output type	One changeover contact	One changeover contact
Operating principle	Open-circuit principle: Output relays pick up when value above/ below set threshold value Closed-circuit principle: output relays drop out when value above/below set threshold value	Open-circuit principle: Output relays pick up when value above/below set threshold value
Contact material	AgCdO	AgCdO
Rated operating voltage (VDE 0110, IEC 664-1, IEC 60947-1)	250 V	250 V
Maximum switching voltage	400 V AC, 300 V DC	400 V AC, 300 V DC
Rated operational current (IEC 60947-5-1, EN 60947-5-1)		
AC12 (resistive) 230 V	5A	5A
AC15 (inductive) 230 V	3A	3A
DC12 (resistive) 24 V	5A	5A
DC13 (inductive) 24 V	2A	2A
Rated operational data AC (UL 508)		
Utilization category (Control Circuit Rating Code)	B300	B300
Max. rated operational voltage	300 V AC	300 V AC
Max. thermal uninterrupted current at B 300	5A	5A
Max. input/output rating (N/O / N/C) for B 300	3600/360 VA	3600/360 VA
Mechanical lifespan	30 x 10 <sup>6</sup> operations	30 x 10 <sup>6</sup> operations
Electrical lifespan (AC12, 230 V, 4 A)	0.1 x 10 <sup>6</sup> operations	0.1 x 10 <sup>6</sup> operations
Short-circuit rating, max. fuse protection, N/C / N/O contact	4 A fast/6 A fast	4 A fast/6 A fast

## EMR

	EMR4-RDC-1-A	EMR4-RAC-1-A
<b>General data</b>		
Enclosure measurements	45 x 78 x 100 mm (1.77 x 3.07 x 3.94 in)	45 x 78 x 100 mm (1.77 x 3.07 x 3.94 in)
Weight	approx. 0.3 kg (0.66 lb)	approx. 0.3 kg (0.66 lb)
Mounting position	Any	Any
Degree of protection of enclosures/terminals	IP50/IP20	IP50/IP20
Ambient temperature range, operation/storage	-25 - +65 °C / -40 - +85 °C	-25 - +65 °C / -40 - +85 °C
Mounting	DIN rail (EN 50022)	DIN rail (EN 50022)
<b>Electrical connection</b>		
Terminal capacity		
Flexible with ferrule	2 x 2.5 mm <sup>2</sup> (2 x 14 AWG)	2 x 2.5 mm <sup>2</sup> (2 x 14 AWG)
<b>Directives and standards</b>		
Product standard	IEC 255-6, EN 60255-6	IEC 255-6, EN 60255-6
Low-Voltage Directive	2006/95/EC	2006/95/EC
EMC Directive	2004/108/EC, 91/263/EEC, 92/31/EEC, 93/68/EEC, 93/67/EEC	2004/108/EC, 91/263/EEC, 92/31/EEC, 93/68/EEC, 93/67/EEC
Electromagnetic compatibility (EMC)	EN 61000-6-2, EN 61000-6-4	EN 61000-6-2, EN 61000-6-4
Electrostatic discharge (ESD) IEC/EN 61000-4-2	Level 3 (6 kV/8 kV)	Level 3 (6 kV/8 kV)
Electromagnetic field (immunity to RF interference) IEC/EN 61000-4-3	Level 3 (10(3)V/m)	Level 3 (10(3)V/m)
Fast transients (burst) IEC/EN 61000-4-4	Level 3 (2(1) kV/5 kHz)	Level 3 (2(1) kV/5 kHz)
High-energy pulses (surge) IEC 1000-4-5, EN 61000-4-5	Level 3 (2(1) kV L-L)	Level 3 (2(1) kV L-L)
Immunity to line-conducted interference, IEC 1000-4-6, EN 61000-4-6	Level 3 (10(3) V)	Level 3 (10(3) V)
Operating safety (IEC 68-2-6)	5 g	5 g
Mechanical strength (IEC 68-2-6)	10 g	10 g
Climatic testing (IEC 68-2-30)	24 h cycle, 55 °C, 93 % rel., 96 h	24 h cycle, 55 °C, 93 % rel., 96 h
<b>Insulation data</b>		
Rating (HD 625.1 S1, VDE 0110, IEC 664-1, IEC 60255-5)		
Rated voltage between supply, measuring, and output circuits	250 V	250 V
Rated impulse withstand voltage between all insulated circuits	4 kV / 1.2 - 50 µs	4 kV / 1.2 - 50 µs
Test voltage between all insulated circuits	2.5 kV, 50 Hz, 1 min.	2.5 kV, 50 Hz, 1 min.
Pollution degree	3	3
Overvoltage category	III	III

# Electronic relays

## Measuring and monitoring relays

### EMR

	EMR5-W300-1-C	EMR5-W380-1	EMR5-W400-1	EMR5-W500-1-D	EMR5-AW300-1-C
<b>Input circuit, measuring circuit</b>					
Main pole, neutral conductor	L1,L2,L3	L1,L2,L3	L1,L2,L3	L1,L2,L3	L1, L2, L3
Rated control voltage $U_S$ = monitored voltage	3 x 160 - 300 V AC	3 x 380 V AC	3 x 400 V AC	3 x 300 - 500 V AC	3 x 160 - 300 V AC
Tolerance of rated control voltage $U_S$	-15 - +10 %	-15 - +10 %	-15 - +10 %	-15 - +10 %	-15 - +10 %
Rated frequency	50/60 Hz	50/60 Hz	50/60 Hz	50/60 Hz	50/60 Hz
Frequency range	45 - 65 Hz	45 - 65 Hz	45 - 65 Hz	45 - 65 Hz	45 - 65 Hz
Typical current/power consumption	25 mA/10 VA /at 250 V AC	25 mA/18 VA /at 380 V AC	25 mA/18 VA /at 400 V AC	25 mA/18 VA /at 400 V AC	25 mA/10 VA (230 V AC)
Duty factor (DF)					
<b>Measuring circuit</b>					
Monitoring functions					
Phase failure	Yes	Yes	Yes	Yes	Yes
Phase sequence	Can be deactivated	Can be deactivated	Can be deactivated	Can be deactivated	Can be deactivated
Automatic phase sequence correction	No	No	No	No	No
Asymmetry	No	No	No	No	Yes
Overvoltage/undervoltage	Yes	Yes	Yes	Yes	Yes
Neutral conductor/break					No
Neutral conductor	No	No	No	No	
Measuring range					
Overvoltage	3 x 220 - 300 v AC	3 x 418 V AC	3 x 440 V AC	3 x 420 - 500 V AC	3 x 220 - 300 V AC
Undervoltage	3 x 160 - 230 V AC	3 x 342 V AC	3 x 360 V AC	3 x 300 - 380 V AC	3 x 160 - 230 V AC
Asymmetry	No	No	No	No	2 - 25 % of phase voltage mean value
Adjustable threshold values					
Overvoltage	Adjustable within measuring range	Fixed	Fixed	Adjustable within measuring range	Adjustable within measuring range
Undervoltage	Adjustable within measuring range	Fixed	Fixed	Adjustable within measuring range	Adjustable within measuring range
Imbalance (disconnection value)	No	No	No	No	Adjustable within measuring range
Asymmetry					
Hysteresis relative to threshold value					
Overvoltage/undervoltage	Fixed 5 %	Fixed 5 %	Fixed 5 %	Fixed 5 %	Fixed 5 %
Asymmetry	No	No	No	No	Fixed 20 %
Rated frequency of measuring signal	50/60 Hz	50/60 Hz	50/60 Hz	50/60 Hz	50/60 Hz
Frequency range of measuring signal	45 - 65 Hz	45 - 65 Hz	45 - 65 Hz	45 - 65 Hz	45 - 65 Hz
Reaction time	No	No	No	No	
Maximum monitoring cycle	100 ms	100 ms	100 ms	100 ms	100 ms
Measuring error within rated control voltage tolerance	$\leq 0.5 \%$	$\leq 0.5 \%$	$\leq 0.5 \%$	$\leq 0.5 \%$	$\leq 0.5 \%$
Measuring error within temperature range	$\leq 0.06 \%/^{\circ}\text{C}$	$\leq 0.06 \%/^{\circ}\text{C}$	$\leq 0.06 \%/^{\circ}\text{C}$	$\leq 0.06 \%/^{\circ}\text{C}$	$\leq 0.06 \%/^{\circ}\text{C}$
Measurement method	True RMS value measurement				
<b>Timing circuit</b>					
On-delay $T_S$	Fixed 200 ms	Fixed 200 ms	Fixed 200 ms	Fixed 200 ms	Fixed 200 ms
On-delay $T_{S1}$					
Response delay $T_V$	On- or off-delay 0; 0, 1-30 s adjustable	On- or off-delay 0; 0, 1-30 s adjustable	On- or off-delay 0; 0, 1-30 s adjustable	On- or off-delay 0; 0, 1-30 s adjustable	On- or off-delay; none = 0, adjustable 0.1 - 30 s
Timeout error within rated control voltage tolerance	$\leq 0.5 \%$	$\leq 0.5 \%$	$\leq 0.5 \%$	$\leq 0.5 \%$	$\leq 0.5 \%$
Timeout error within temperature range	$\leq 0.06 \%/^{\circ}\text{C}$	$\leq 0.06 \%/^{\circ}\text{C}$	$\leq 0.06 \%/^{\circ}\text{C}$	$\leq 0.06 \%/^{\circ}\text{C}$	$\leq 0.06 \%/^{\circ}\text{C}$
Repetition accuracy (constant parameters)	$\pm 0.2 \%$	$\pm 0.2 \%$	$\pm 0.2 \%$	$\pm 0.2 \%$	$\pm 0.2 \%$
<b>Operating status indication</b>					
Relay status R: yellow LED	See instructional leaflet	See instructional leaflet	See instructional leaflet	See instructional leaflet	See instructional leaflet



EMR5-AW500-1-D	EMR5-AWM580-2	EMR5-AWM720-2	EMR5-AWM820-2	EMR5-AWN170-1-E	EMR5-AWN280-1	EMR5-AWN280-1-F	EMR5-AWN500-1
L1, L2, L3	L1, L2, L3	L1, L2, L3	L1, L2, L3	L1, L2, L3, N	L1,L2,L3 N	L1, L2, L3, N	L1,L2,L3
3 x 300 - 500 V AC	3 x 350 - 580 V AC	3 x 450 - 720 V AC	3 x 530 - 820 V AC	3 x 90 - 170 V AC	3 x 180 - 280 V AC	3 x 180 - 280 V AC	3 x 300 - 500 V AC
-15 - +10 %	-15 - +10 %	-15 - +10 %	-15 - +10 %	-15 - +10 %	-15 - +10 %	-15 - +10 %	-15 - +10 %
50/60 Hz	50/60 Hz	50/60 Hz	50/60 Hz	50/60 Hz	50/60/400 Hz	50/60 Hz	50/60/400 Hz
45 - 65 Hz	45 - 65 Hz	45 - 65 Hz	45 - 65 Hz	45 - 65 Hz	45 - 440 Hz	45 - 65 Hz	45 - 440 Hz
25 mA/18 VA (400 V AC)	29 mA/41 VA (480 V AC)	29 mA/52 VA (600 V AC)	29 mA/59 VA (690 V AC)	25 mA / 10 VA (115 V AC)	5 mA/4 VA (230 V AC)	25 mA/18 VA (230 V AC)	5 mA/4 VA (400 V AC)
	100%	100%	100%		100%		100%
Yes	Yes	Yes	Yes	Yes	Yes	Yes	Yes
Can be deactivated	Can be deactivated	Can be deactivated	Can be deactivated	Can be deactivated	Can be deactivated	Can be deactivated	Can be deactivated
No	Yes	Yes	Yes	No	Yes	No	Yes
Yes	Yes	Yes	Yes	Yes	Yes	Yes	Yes
Yes	Yes	Yes	Yes	Yes	Yes	Yes	Yes
No	No	No	No	Yes	Yes	Yes	No
3 x 420 - 500 V AC	3 x 480 - 580 V AC	3 x 690 - 820 V AC	3 x 690 - 820 V AC	3 x 120 - 170 V AC	3 x 240 - 280 V AC	3 x 240 - 280 V AC	3 x 420 - 500 V AC
3 x 300 - 380 V AC	3 x 450 - 570 V AC	3 x 530 - 660 V AC	3 x 530 - 660 V AC	3 x 90 - 130 V AC	3 x 180 - 220 V AC	3 x 180 - 220 V AC	3 x 300 - 380 V AC
2 - 25 % of phase voltage mean value	2 - 25 % of phase voltage mean value	2 - 25 % of phase voltage mean value	2 - 25 % of phase voltage mean value	2 - 25 % of phase voltage mean value	2 - 25 % of phase voltage mean value	2 - 25 % of phase voltage mean value	2 - 25 % of phase voltage mean value
Adjustable within measuring range	Adjustable within measuring range	Adjustable within measuring range	Adjustable within measuring range	Adjustable within measuring range	Adjustable within measuring range	Adjustable within measuring range	Adjustable within measuring range
Adjustable within measuring range	Adjustable within measuring range	Adjustable within measuring range	Adjustable within measuring range	Adjustable within measuring range	Adjustable within measuring range	Adjustable within measuring range	Adjustable within measuring range
Adjustable within measuring range	2 - 25 % of phase voltage mean value	2 - 25 % of phase voltage mean value	2 - 25 % of phase voltage mean value	Adjustable within measuring range	Adjustable within measuring range	Adjustable within measuring range	Adjustable within measuring range
	Adjustable within measuring range	Adjustable within measuring range	Adjustable within measuring range	Adjustable within measuring range	Adjustable within measuring range	Adjustable within measuring range	Adjustable within measuring range
Fixed 5 %	Fixed 5 %	Fixed 5 %	Fixed 5 %	Fixed 5 %	Fixed 5 %	Fixed 5 %	Fixed 5 %
Fixed 20 %	Fixed 20 %	Fixed 20 %	Fixed 20 %	Fixed 20 %	Fixed 20 %	Fixed 20 %	Fixed 20 %
50/60 Hz	50/60 Hz	50/60 Hz	50/60 Hz	50/60 Hz	50/60/400 Hz	50/60 Hz	50/60/400 Hz
45 - 65 Hz	45 - 65 Hz	45 - 65 Hz	45 - 65 Hz	45 - 65 Hz	45 - 440 Hz	45 - 65 Hz	45 - 440 Hz
100 ms	100 ms	100 ms	100 ms	100 ms	100 ms	100 ms	100 ms
≤ 0.5 %	≤ 0.5 %	≤ 0.5 %	≤ 0.5 %	≤ 0.5 %	≤ 0.5 %	≤ 0.5 %	≤ 0.5 %
≤ 0.06 %/°C	≤ 0.06 %/°C	≤ 0.06 %/°C	≤ 0.06 %/°C	≤ 0.06 %/°C	≤ 0.06 %/°C	≤ 0.06 %/°C	≤ 0.06 %/°C
True RMS value measurement							
Fixed 200 ms	Fixed 200 ms Fixed 250 ms	Fixed 200 ms Fixed 250 ms	Fixed 200 ms Fixed 250 ms	Fixed 200 ms	Fixed 200 ms Fixed 250 ms	Fixed 200 ms	Fixed 200 ms Fixed 250 ms
On- or off-delay; none = 0, adjustable 0.1 - 30 s	On- or off-delay; none = 0, adjustable 0.1 - 30 s	On- or off-delay; none = 0, adjustable 0.1 - 30 s	On- or off-delay; none = 0, adjustable 0.1 - 30 s	On- or off-delay; none = 0, adjustable 0.1 - 30 s	On- or off-delay; none = 0, adjustable 0.1 - 30 s	On- or off-delay; none = 0, adjustable 0.1 - 30 s	On- or off-delay; none = 0, adjustable 0.1 - 30 s
≤ 0.5 %	≤ 0.5 %	≤ 0.5 %	≤ 0.5 %	≤ 0.5 %	≤ 0.5 %	≤ 0.5 %	≤ 0.5 %
≤ 0.06 %/°C	≤ 0.06 %/°C	≤ 0.06 %/°C	≤ 0.06 %/°C	≤ 0.06 %/°C	≤ 0.06 %/°C	≤ 0.06 %/°C	≤ 0.06 %/°C
±0.2 %	±0.2 %	±0.2 %	±0.2 %	±0.2 %	±0.2 %	±0.2 %	±0.2 %
See instructional leaflet	See instructional leaflet	See instructional leaflet	See instructional leaflet	See instructional leaflet	See instructional leaflet	See instructional leaflet	See instructional leaflet

# Electronic relays

## Measuring and monitoring relays

### EMR

	EMR5-W300-1-C	EMR5-W380-1	EMR5-W400-1	EMR5-W500-1-D	EMR5-AW300-1-C
<b>Output circuits</b>					
Output circuits	15-16/18, 25-26/28	15-16/18, 25-26/28	15-16/18, 25-26/28	15-16/18, 25-26/28	15-16/18, 25-26/28
Output type	2 x 1 relay (changeover contact)	2 x 1 relay (changeover contact)	2 x 1 relay (changeover contact)	2 x 1 relay (changeover contact)	1 x 2 relays (changeover contact)
Operating principle	Closed-circuit principle: Output relays drop out when value above/below set threshold value				
Contact material	AgNi alloy, Cd-free				
Rated operating voltage (VDE 0110, IEC 60947-1)	250 V	250 V	250 V	250 V	250 V
Minimum switching voltage/minimum switching current	No	No	No	No	No
Minimum switching duty	24 V/10 mA	24 V/10 mA	24 V/10 mA	24 V/10 mA	24 V/10 mA
Maximum switching voltage	See TB_EMR_PRO_01	See TB_EMR_PRO_01	See TB_EMR_PRO_01	See TB_EMR_PRO_01	See TB_EMR_PRO_01
Rated operational current (IEC 60947-5-1)					
AC12 (resistive) at 230 V	4 A	4 A	4 A	4 A	4 A
AC15 (inductive) at 230 V	3 A	3 A	3 A	3 A	3 A
DC12 (resistive) at 24 V	4 A	4 A	4 A	4 A	4 A
DC13 (inductive) at 24 V	2 A	2 A	2 A	2 A	2 A
Rated operational data AC (UL 508)					
Utilization category (Control Circuit Rating Code)	B 300	B 300	B 300	B 300	B 300
Max. rated operational voltage	300 V AC	300 V AC	300 V AC	300 V AC	300 V AC
Max. thermal uninterrupted current at B 300	5 A	5 A	5 A	5 A	5 A
Max. input/output rating(N/O / N/C) for B 300	3600/360 VA	3600/360 VA	3600/360 VA	3600/360 VA	3600/360 VA
Mechanical lifespan					
	30 x 10 <sup>6</sup> operations	30 x 10 <sup>6</sup> operations	30 x 10 <sup>6</sup> operations	30 x 10 <sup>6</sup> operations	30 x 10 <sup>6</sup> operations
Electrical lifespan (AC12, 230 V, 4 A)					
	0.1 x 10 <sup>6</sup> operations	0.1 x 10 <sup>6</sup> operations	0.1 x 10 <sup>6</sup> operations	0.1 x 10 <sup>6</sup> operations	0.1 x 10 <sup>6</sup> operations
Short-circuit strength, maximum fuse rating					
Normally closed contact	6 A fast	6 A fast	6 A fast	6 A fast	6 A fast
Normally open contact	10 A fast	10 A fast	10 A fast	10 A fast	10 A fast
Duty factor (DF)	100 %	100 %	100 %	100 %	100 %
<b>General data</b>					
Enclosure measurements (w x h x d)					
	22.5 x 78 x 100 mm (0.89 x 3.07 x 3.94 inches)	22.5 x 78 x 100 mm (0.89 x 3.07 x 3.94 inches)	22.5 x 78 x 100 mm (0.89 x 3.07 x 3.94 inches)	22.5 x 78 x 100 mm (0.89 x 3.07 x 3.94 inches)	22.5 x 78 x 100 mm (0.89 x 3.07 x 3.94 inches)
Mounting position	Any	Any	Any	Any	Any
Weight					0.13 kg (0.29 lb)
Degree of protection of enclosures/terminals	IP50/IP20	IP50/IP20	IP50/IP20	IP50/IP20	IP50/IP20
Mounting	DIN rail (IEC/EN 60715), clip-type toolless				
Minimum distance to adjacent devices					
Horizontal (min. 10 mm from continuous voltage)	> 220 V	> 400 V	> 400 V	> 400 V	> 220 V
Vertical	None	None	None	None	None
<b>Electrical connection</b>					
Terminal capacities					
Flexible with ferrule	2 x 0.75-2.5 mm <sup>2</sup> (2 x 18 - 14 AWG)				
Flexible without ferrule	2 x 0.75-2.5 mm <sup>2</sup> (2 x 18 - 14 AWG)				
Rigid	2 x 0.5-4 mm <sup>2</sup> (2 x 20 - 12 AWG)				
Stripped length	7 mm (0.28 inches)	7 mm (0.28 inches)	7 mm (0.28 inches)	7 mm (0.28 inches)	7 mm (0.28 inches)
Tightening torque	0.6 - 0.8 Nm	0.6 - 0.8 Nm	0.6 - 0.8 Nm	0.6 - 0.8 Nm	0.6 - 0.8 Nm
<b>Environmental data</b>					
Ambient temperature range, operation/storage					
	-25 - +60 °C / -40 - +85 °C				
Damp heat (IEC 60068-2-30)					
	55 °C, 6 cycles				
Climate class					
	3K3				
Vibration (sinusoidal) (IEC/EN) 60255-21-1)					
	Class 2				
Impact (IEC/EN 60255-21-2)					
	Class 2				

# Electronic relays

## Measuring and monitoring relays

EMR5-AW500-1-D	EMR5-AWM580-2	EMR5-AWM720-2	EMR5-AWM820-2	EMR5-AWN170-1-E	EMR5-AWN280-1	EMR5-AWN280-1-F	EMR5-AWN500-1
15-16/18, 25-26/28	15-16/18, 25-26/28	15-16/18, 25-26/28	15-16/18, 25-26/28	15-16/18, 25-26/28	15-16/18, 25-26/28	15-16/18, 25-26/28	15-16/18, 25-26/28
1 x 2 relays (changeover contact)	2 x 1 or 1 x 2 changeover contact, selectable (relay)	2 x 1 or 1 x 2 changeover contact, selectable (relay)	2 x 1 or 1 x 2 changeover contact, selectable (relay)	1 x 2 relays (changeover contact)	2 x 1 or 1 x 2 changeover contact, selectable (relay)	1 x 2 relays (changeover contact)	2 x 1 or 1 x 2 changeover contact, selectable (relay)
250 V	250 V	250 V	250 V	250 V	250 V	250 V	250 V
24 V/10 mA	24 V/10 mA	24 V/10 mA	24 V/10 mA	25 V/10 mA	26 V/10 mA	27 V/10 mA	28 V/10 mA
See TB_EMR_PRO_01	See TB_EMR_PRO_02	See TB_EMR_PRO_02	See TB_EMR_PRO_02	See TB_EMR_PRO_01	See TB_EMR_PRO_01	See TB_EMR_PRO_01	
4 A	4 A	4 A	4 A	4 A	4 A	4 A	4 A
3 A	3 A	3 A	3 A	3 A	3 A	3 A	3 A
4 A	4 A	4 A	4 A	4 A	4 A	4 A	4 A
2 A	2 A	2 A	2 A	2 A	2 A	2 A	2 A
B 300	B 300	B 300	B 300	B 300	B 300	B 300	B 300
300 V AC	300 V AC	300 V AC	300 V AC	300 V AC	300 V AC	300 V AC	300 V AC
5 A	5 A	5 A	5 A	5 A	5 A	5 A	5 A
3600/360 VA	3600/360 VA	3600/360 VA	3600/360 VA	3600/360 VA	3600/360 VA	3600/360 VA	3600/360 VA
30 x 10 <sup>6</sup> operations	30 x 10 <sup>6</sup> operations	30 x 10 <sup>6</sup> operations	30 x 10 <sup>6</sup> operations	30 x 10 <sup>6</sup> operations	30 x 10 <sup>6</sup> operations	30 x 10 <sup>6</sup> operations	30 x 10 <sup>6</sup> operations
0.1 x 10 <sup>6</sup> operations	0.1 x 10 <sup>6</sup> operations	0.1 x 10 <sup>6</sup> operations	31 x 10 <sup>6</sup> operations	31 x 10 <sup>6</sup> operations	0.1 x 10 <sup>6</sup> operations	0.1 x 10 <sup>6</sup> operations	0.1 x 10 <sup>6</sup> operations
6 A fast	10 A fast	10 A fast	10 A fast	6 A fast	6 A fast	6 A fast	6 A fast
10 A fast	10 A fast	10 A fast	10 A fast	10 A fast	10 A fast	10 A fast	10 A fast
100 %	100 %	100 %	100 %	100 %	100 %	100 %	100 %
22.5 x 78 x 100 mm (0.89 x 3.07 x 3.94 inches)	45 x 78 x 100 mm (1.78 x 3.07 x 3.94 inches)	45 x 78 x 100 mm (1.78 x 3.07 x 3.94 inches)	45 x 78 x 100 mm (1.78 x 3.07 x 3.94 inches)	22.5 x 78 x 100 mm (0.89 x 3.07 x 3.94 inches)	22.5 x 78 x 100 mm (0.89 x 3.07 x 3.94 inches)	22.5 x 78 x 100 mm (0.89 x 3.07 x 3.94 inches)	22.5 x 78 x 100 mm (0.89 x 3.07 x 3.94 inches)
Any	Any	Any	Any	Any	Any	Any	Any
0.13 kg (0.29 lb)	0.22 kg (0.49 lb)	0.22 kg (0.49 lb)	0.22 kg (0.49 lb)	0.14 kg (0.31 lb)	0.14 kg (0.31 lb)	0.14 kg (0.31 lb)	0.13 kg (0.29 lb)
IP50/IP20	IP50/IP20	IP50/IP20	IP50/IP20	IP50/IP21	IP50/IP20	IP50/IP20	IP50/IP20
> 400 V	None	None	None	> 120 V	None	> 240 V	None
None	None	None	None	None	None	None	None
7 mm (0.28 inches)	7 mm (0.28 inches)	7 mm (0.28 inches)	7 mm (0.28 inches)	7 mm (0.28 inches)	7 mm (0.28 inches)	7 mm (0.28 inches)	7 mm (0.28 inches)
0.6 - 0.8 Nm	0.6 - 0.8 Nm	0.6 - 0.8 Nm	0.6 - 0.8 Nm	0.6 - 0.8 Nm	0.6 - 0.8 Nm	0.6 - 0.8 Nm	0.6 - 0.8 Nm
55 °C, 6 cycles	55 °C, 6 cycles	55 °C, 6 cycles	55 °C, 6 cycles	55 °C, 6 cycles	55 °C, 6 cycles	55 °C, 6 cycles	55 °C, 6 cycles
3K3	3K3	3K3	3K3	3K3	3K3	3K3	3K3
Class 2	Class 2	Class 2	Class 2	Class 2	Class 2	Class 2	Class 2
Class 2	Class 2	Class 2	Class 2	Class 2	Class 2	Class 2	Class 2

# Electronic relays

## EMR

	EMR5-W300-1-C	EMR5-W380-1	EMR5-W400-1	EMR5-W500-1-D	EMR5-AW300-1-C
<b>Insulation data</b>					
Rated insulation voltage $U_i$					
Input circuit/output circuit	600 V	600 V	600 V	600 V	600 V
Input circuit 1/output circuit 2	300 V	300 V	300 V	300 V	300 V
Rated impulse withstand voltage $U_{imp}$ (VDE 0110, IEC/EN 60664)					
Input circuit	6 kV; 1.2/50 $\mu$ s	6 kV; 1.2/50 $\mu$ s	6 kV; 1.2/50 $\mu$ s	6 kV; 1.2/50 $\mu$ s	6 kV; 1.2/50 $\mu$ s
Output circuits	4 kV; 1.2/50 $\mu$ s	4 kV; 1.2/50 $\mu$ s	4 kV; 1.2/50 $\mu$ s	4 kV; 1.2/50 $\mu$ s	4 kV; 1.2/50 $\mu$ s
Test voltage between all insulated circuits (routine test)					
Input circuit and insulated output circuits	2.5 kV, 50 Hz, 1 s	2.5 kV, 50 Hz, 1 s	2.5 kV, 50 Hz, 1 s	2.5 kV, 50 Hz, 1 s	2.5 kV, 50 Hz, 1 s
Basic insulation, input circuit/output circuit					
Safe isolation (VDE 0160 Part 101 and 101/A1, IEC/EN 61140) input circuit/output circuit	No	No	No	No	No
Pollution degree (VDE 0110, IEC/EN 60664, UL 508)					
Overvoltage category (VDE 0110, IEC 60664, UL 508)	III	III	III	III	III
<b>Directives and standards</b>					
Product standard IEC/EN 60255-6, EN 50178					
Low-Voltage Directive	2006/95/EC	2006/95/EC	2006/95/EC	2006/95/EC	2006/95/EC
EMC Directive	2004/108/EC	2004/108/EC	2004/108/EC	2004/108/EC	2004/108/EC
RoHS Directive	2002/95/EC	2002/95/EC	2002/95/EC	2002/95/EC	2002/95/EC
<b>Electromagnetic compatibility</b>					
Interference immunity EN 61000-6-1, EN 61000-6-2					
Electrostatic discharge (ESD) IEC/EN 61000-4-2	Level 3 (6 kV/8 kV)	Level 3 (6 kV/8 kV)	Level 3 (6 kV/8 kV)	Level 3 (6 kV/8 kV)	Level 3 (6 kV/8 kV)
Electromagnetic field (immunity to RF interference) IEC/EN 61000-4-3					
Fast transients (burst) IEC/EN 61000-4-4	Level 3 (2 kV/2 kHz)	Level 3 (2 kV/2 kHz)	Level 3 (2 kV/2 kHz)	Level 3 (2 kV/2 kHz)	Level 3 (2 kV/2 kHz)
High-energy pulses (surge) IEC 1000-4-5, EN 61000-4-5					
Cable-borne HF IEC 100-4-6, EN 61000-4-6	Level 4 (2 kV L-L)	Level 4 (2 kV L-L)	Level 4 (2 kV L-L)	Level 4 (2 kV L-L)	Level 4 (2 kV L-N)
Resistance to harmonics EN 61000-4-13					
Emitted interference	Class 3	Class 3	Class 3	Class 3	Class 3
Electromagnetic field (immunity to RF interference) IEC/CISPR 22, EN 50022					
Cable-borne HF	Class B	Class B	Class B	Class B	Class B

## Dimensions

### Measuring and monitoring relays

EMR-...

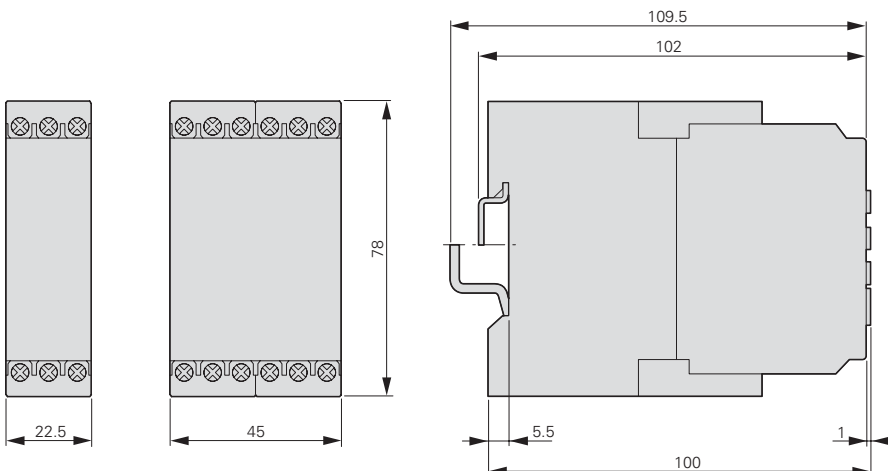

EMR5-AW500-1-D	EMR5-AWM580-2	EMR5-AWM720-2	EMR5-AWM820-2	EMR5-AWN170-1-E	EMR5-AWN280-1	EMR5-AWN280-1-F	EMR5-AWN500-1
600 V	1000 V	1000 V	1000 V	600 V	600 V	600 V	600 V
300 V	300 V	300 V	300 V	300 V	300 V	300 V	300 V
6 kV; 1.2/50 $\mu$ s	8 kV; 1.2/50 $\mu$ s	8 kV; 1.2/50 $\mu$ s	8 kV; 1.2/50 $\mu$ s	6 kV; 1.2/50 $\mu$ s	6 kV; 1.2/50 $\mu$ s	6 kV; 1.2/50 $\mu$ s	6 kV; 1.2/50 $\mu$ s
4 kV; 1.2/50 $\mu$ s	4 kV; 1.2/50 $\mu$ s	4 kV; 1.2/50 $\mu$ s	4 kV; 1.2/50 $\mu$ s	4 kV; 1.2/50 $\mu$ s	4 kV; 1.2/50 $\mu$ s	4 kV; 1.2/50 $\mu$ s	4 kV; 1.2/50 $\mu$ s
2.5 kV, 50 Hz, 1 s	2.5 kV, 50 Hz, 1 s	2.5 kV, 50 Hz, 1 s	2.5 kV, 50 Hz, 1 s	2.5 kV, 50 Hz, 1 s	2.5 kV, 50 Hz, 1 s	2.5 kV, 50 Hz, 1 s	2.5 kV, 50 Hz, 1 s
	4 kV, 50 Hz, 1 s	4 kV, 50 Hz, 1 s	4 kV, 50 Hz, 1 s		2.5 kV, 50 Hz, 1 s		2.5 kV, 50 Hz, 1 s
600 V	1000 V	1000 V	1000 V	600 V	600 V	600 V	600 V
No	No	No	No	Yes	No	Yes	No
3	III	III	III	3	III	3	III
III	3	3	3	III	3	III	3
2006/95/EC	2006/95/EC	2006/95/EC	2006/95/EC	2006/95/EC	2006/95/EC	2006/95/EC	2006/95/EC
2004/108/EC	2004/108/EC	2004/108/EC	2004/108/EC	2004/108/EC	2004/108/EC	2004/108/EC	2004/108/EC
2002/95/EC	2002/95/EC	2002/95/EC	2002/95/EC	2002/95/EC	2002/95/EC	2002/95/EC	2002/95/EC
Level 3 (6 kV/8 kV)	Level 3 (6 kV/8 kV)	Level 3 (6 kV/8 kV)	Level 3 (6 kV/8 kV)	Level 3 (6 kV / 8 kV)	Level 3 (6 kV/8 kV)	Level 3 (6 kV/8 kV)	Level 3 (6 kV/8 kV)
Level 3 (10 V/m)	Level 3 (10 V/m)	Level 3 (10 V/m)	Level 3 (10 V/m)	Level 3 (10 V/m)	Level 3 (10 V/m)	Level 3 (10 V/m)	Level 3 (10 V/m)
Level 3 (2 kV/2 kHz)	Level 3 (2 kV/2 kHz)	Level 3 (2 kV/2 kHz)	Level 3 (2 kV/2 kHz)	Level 3 (2 kV / 2 kHz)	Level 3 (2 kV/2 kHz)	Level 3 (2 kV/2 kHz)	Level 3 (2 kV/2 kHz)
Level 4 (2 kV L-N)	Level 4 (2 kV L-L)	Level 4 (2 kV L-L)	Level 4 (2 kV L-L)	Level 4 (2 kV L-N)	Level 4 (2 kV L-N)	Level 4 (2 kV L-N)	Level 4 (2 kV L-L)
Level 3 (10 V)	Level 3 (10 V)	Level 3 (10 V)	Level 3 (10 V)	Level 3 (10 V)	Level 3 (10 V)	Level 3 (10 V)	Level 3 (10 V)
Class 3	Class 3	Class 3	Class 3	Class 3	Class 3	Class 3	Class 3
Class B	Class B	Class B	Class B	Class B	Class B	Class B	Class B
Class B	Class B	Class B	Class B	Class B	Class B	Class B	Class B

## Sealable shrouds

EMR4-PH...

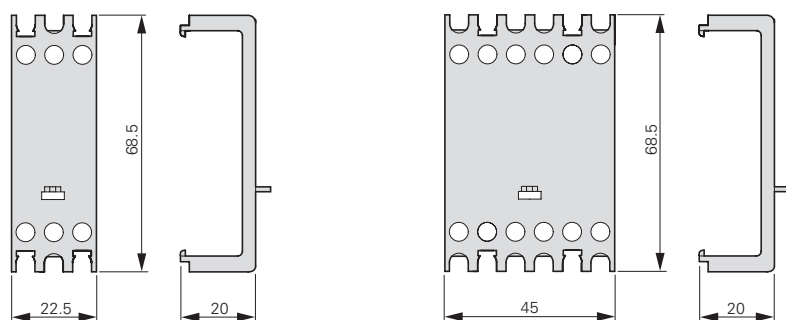

Eaton is dedicated to ensuring that reliable, efficient and safe power is available when it's needed most. With unparalleled knowledge of electrical power management across industries, experts at Eaton deliver customized, integrated solutions to solve our customers' most critical challenges.

Our focus is on delivering the right solution for the application. But, decision makers demand more than just innovative products. They turn to Eaton for an unwavering commitment to personal support that makes customer success a top priority. For more information, **visit [www.eaton.com/electrical](http://www.eaton.com/electrical)**.

**Electrical Sector Asia Pacific**  
No.3, Lane 280, Linhong Road,  
Changning District, Shanghai

Eaton Industries Pte Ltd  
Electrical Sector  
4 Loyang Lane #04-01/02  
Singapore 508914

© 2012 Eaton Corporation  
All Rights Reserved  
Printed in Singapore  
EMR5-SEA-EN  
July 2012

Eaton is a registered trademark  
of Eaton Corporation.

All other trademarks are property  
of their respective owners.



*Powering Business Worldwide*