





Circuit breakers - TeSys GV, GB			Pages
Type of product	Range		
Magnetic circuit breakers for motors TeSys GV	Up to 15, 30 kW		B6/2
Thermal magnetic circuit breakers for motors TeSys GV	Up to 15, 37 or 110 kW		B6/4
Add-on blocks, accessories, for motor circuit breakers			B6/10
Thermal magnetic circuit breakers for control circuits, Solenoid valves or transformers TeSys GB, GV	From 0.5 to 23 A		B6/26

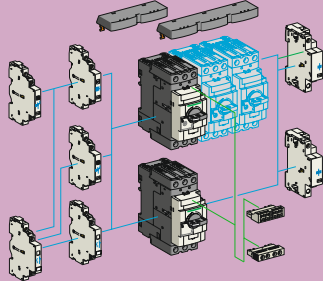

GV2 LE10

Magnetic motor circuit breakers from 0.06 to 15 kW												
GV2 LE: control by rocker lever, connection by screw clamp terminals												
Standard power ratings of 3-phase motors 50/60 Hz in category AC-3									Magnetic protection rating	Tripping current I <sub>d</sub> ± 20 %	Use in association with thermal overload relay	Reference
400/415 V			500 V			690 V						
P	I <sub>cu</sub>	I <sub>cs</sub> <sup>(1)</sup>	P	I <sub>cu</sub>	I <sub>cs</sub> <sup>(1)</sup>	P	I <sub>cu</sub>	I <sub>cs</sub> <sup>(1)</sup>	A	A		
kW	kA		kW	kA		kW	kA		A	A		
0.06	*	*	-	-	-	-	-	-	0.4	5	LR2 K0302	GV2LE03
0.09	*	*	-	-	-	-	-	-	0.4	5	LR2 K0304	GV2LE03
0.12	*	*	-	-	-	0.37	*	*	0.63	8	LR2 K0304	GV2LE04
0.18	*	*	-	-	-	-	-	-	0.63	8	LR2 K0305	GV2LE04
-	-	-	-	-	-	0.55	*	*	1	13	LR2 K0305	GV2LE05
0.25	*	*	-	-	-	-	-	-	1	13	LR2 K0306	GV2LE05
-	-	-	-	-	-	0.75	*	*	1	13	LR2 K0306	GV2LE05
0.37	*	*	0.37	*	*	-	-	-	1	13	LR2 K0306	GV2LE05
0.55	*	*	0.55	*	*	1.1	*	*	1.6	22.5	LR2 K0307	GV2LE06
-	-	-	0.75	*	*	-	-	-	1.6	22.5	LR2 K0307	GV2LE06
0.75	*	*	1.1	*	*	1.5	3	75	2.5	33.5	LR2 K0308	GV2LE07
1.1	*	*	-	-	-	-	-	-	2.5	33.5	LR2 K0308	GV2LE07
1.5	*	*	1.5	*	*	3	3	75	4	51	LR2 K0310	GV2LE08
-	-	-	2.2	*	*	-	-	-	4	51	LR2 K0312	GV2LE08
2.2	*	*	3	50	100	4	3	75	6.3	78	LR2 K0312	GV2LE10
3	*	*	4	10	100	5.5	3	75	10	138	LR2 K0314	GV2LE14
4	*	*	5.5	10	100	-	-	-	10	138	LR2 K0316	GV2LE14
-	-	-	-	-	-	7.5	3	75	10	138	LRD 14	GV2LE14
-	-	-	-	-	-	9	3	75	14	170	LRD 16	GV2LE16
5.5	15	50	7.5	6	75	11	3	75	14	170	LR2 K0321	GV2LE16
7.5	15	50	9	6	75	15	3	75	18	223	LRD 21	GV2LE20
9	15	40	11	4	75	18.5	3	75	25	327	LRD 22	GV2LE22
11	15	40	15	4	75	-	-	-	25	327	LRD 22	GV2LE22
15	10	50	18.5	4	75	22	3	75	32	416	LRD 32	GV2LE32

(1) As % of I<sub>cu</sub>.

\* &gt; 100 kA.

## TeSys protection components

## Magnetic motor circuit breakers

## GV2 L, GV3 L and GK3 EF80

## TeSys GV



GV2 L10



GV3 L65

## Motor circuit breakers from 0.09 to 30 kW

## GV2 L: Control by rotary knob, connection by screw clamp terminals

Standard power ratings of 3-phase motors 50/60 Hz in category AC-3									Magnetic protection rating	Tripping current I <sub>d</sub> ± 20 %	Use in association with thermal overload relay (class 10 A)	Reference
400/415 V			500 V			690 V						
P	I <sub>cu</sub>	I <sub>cs</sub> <sup>(1)</sup>	P	I <sub>cu</sub>	I <sub>cs</sub> <sup>(1)</sup>	P	I <sub>cu</sub>	I <sub>cs</sub> <sup>(1)</sup>				
kW	kA		kW	kA		kW	kA		A	A		
0.09	*	*	-	-	-	-	-	-	0.4	5	LRD 03	GV2L03
0.12	*	*	-	-	-	0.37	*	*	0.63	8	LRD 04	GV2L04
0.18	*	*	-	-	-	-	-	-	0.63	8	LRD 04	GV2L04
-	-	-	-	-	-	0.55	*	*	1	13	LRD 05	GV2L05
0.25	*	*	-	-	-	-	-	-	1	13	LRD 05	GV2L05
-	-	-	-	-	-	0.75	*	*	1	13	LRD 06	GV2L05
0.37	*	*	0.37	*	*	-	-	-	1	13	LRD 05	GV2L05
0.55	*	*	0.55	*	*	1.1	*	*	1.6	22.5	LRD 06	GV2L06
-	-	-	0.75	*	*	-	-	-	1.6	22.5	LRD 06	GV2L06
0.75	*	*	1.1	*	*	1.5	4	100	2.5	33.5	LRD 07	GV2L07
1.1	-	-	-	-	-	-	-	-	-	-	LRD 08	GV2L08
1.5	*	*	1.5	*	*	3	4	100	4	51	LRD 08	GV2L08
-	-	-	-	-	-	-	-	-	-	-	LRD 08	GV2L08
2.2	*	*	3	*	*	4	4	100	6.3	78	LRD 10	GV2L10
3	*	*	4	10	100	5.5	4	100	10	138	LRD 12	GV2L14
4	-	-	-	-	-	-	-	-	-	-	LRD 14	GV2L14
-	-	-	-	-	-	7.5	4	100	10	138	LRD 14	GV2L14
-	-	-	-	-	-	9	4	100	14	170	LRD 16	GV2L16
5.5	50	50	7.5	10	75	11	4	100	14	170	LRD 16	GV2L16
7.5	50	50	9	10	75	15	4	100	18	223	LRD 21	GV2L20
9	50	50	11	10	75	18.5	4	100	25	327	LRD 22	GV2L22
11	50	50	15	10	75	-	-	-	25	327	LRD 22	GV2L22
15	50	50	18.5	10	75	22	4	100	32	416	LRD 32	GV2L32

## GV3 L: control by rotary knob, connection by EverLink® BTR screw connectors

Standard power ratings of 3-phase motors 50/60 Hz in category AC-3									Magnetic protection rating	Tripping current I <sub>d</sub> ± 20 %	Use in association with thermal overload relay (class 10 A)	Reference
400/415 V			500 V			690 V						
P	I <sub>cu</sub>	I <sub>cs</sub> <sup>(1)</sup>	P	I <sub>cu</sub>	I <sub>cs</sub> <sup>(1)</sup>	P	I <sub>cu</sub>	I <sub>cs</sub> <sup>(1)</sup>				
kW	kA		kW	kA		kW	kA		A	A		
11	100	100	15	12	50	18.5	6	50	25	350	LRD 325	GV3L25
15	100	100	18.5	12	50	22	6	50	32	448	LRD 332	GV3L32
18.5	50	100	22	12	50	37	6	50	40	560	LRD 340	GV3L40
22	50	100	30	12	50	45	6	50	50	700	LRD 350	GV3L50
30	50	100	37	12	50	55	6	50	65	910	LRD 365	GV3L65

## Connection by EverLink® BTR screw connectors, for assembly with a contactor

To assemble a **GV3 L25** to **L65** circuit breaker with an **LC1 D40A** to **D65A** contactor, it is possible to use the circuit breaker supplied without downstream EverLink® power terminal block. To order this product, add the digit **1** to the end of the references selected above. Example: **GV3 L65** becomes **GV3 L651**.

## Connection by lugs

To order these circuit breakers with connection by lugs, add the digit **6** to the end of reference selected above. Example: **GV3 L32** becomes **GV3 L326**.

<sup>(1)</sup> As % of I<sub>cu</sub>. Associated current limiter or fuses, where required. See characteristics page B6/33.

\* > 100 kA.

# TeSys protection components

## Thermal-magnetic motor circuit breakers

### GV2 ME

## TeSys GV



GV2 ME10

#### Motor circuit breakers from 0.06 to 15 kW / 400 V, with screw clamp terminals

##### GV2 ME with pushbutton control

Standard power ratings of 3-phase motors  
50/60 Hz in category AC-3

400/415 V			500 V			690 V			Setting range of thermal trips <sup>(2)</sup>	Magnetic tripping current I <sub>d</sub> ± 20 %	Reference
P	I <sub>cu</sub>	I <sub>cs</sub> <sup>(1)</sup>	P	I <sub>cu</sub>	I <sub>cs</sub> <sup>(1)</sup>	P	I <sub>cu</sub>	I <sub>cs</sub> <sup>(1)</sup>			
kW	kA	%	kW	kA	%	kW	kA	%	A	A	
–	–	–	–	–	–	–	–	–	0.1...0.16	1.5	GV2ME01
0.06	*	*	–	–	–	–	–	–	0.16...0.25	2.4	GV2ME02
0.09	*	*	–	–	–	–	–	–	0.25...0.40	5	GV2ME03
0.12	*	*	–	–	–	0.37	*	*	0.40...0.63	8	GV2ME04
0.18	*	*	–	–	–	–	–	–			
0.25	*	*	–	–	–	0.55	*	*	0.63...1	13	GV2ME05
0.37	*	*	0.37	*	*	–	–	–	1...16	22.5	GV2ME06
0.55	*	*	0.55	*	*	0.75	*	*			
–	–	–	0.75	*	*	1.1	*	*			
0.75	*	*	1.1	*	*	1.5	3	75	1.6...2.5	33.5	GV2ME07
1.1	*	*	1.5	*	*	2.2	3	75	2.5...4	51	GV2ME08
1.5	*	*	2.2	*	*	3	3	75			
2.2	*	*	3	50	100	4	3	75	4...6.3	78	GV2ME10
3	*	*	4	10	100	5.5	3	75	6...10	138	GV2ME14
4	*	*	5.5	10	100	7.5	3	75			
5.5	15	50	7.5	6	75	9	3	75	9...14	170	GV2ME16
–	–	–	–	–	–	11	3	75			
7.5	15	50	9	6	75	15	3	75	13...18	223	GV2ME20
9	15	40	11	4	75	18.5	3	75	17...23	327	GV2ME21
11	15	40	15	4	75	–	–	–	20...25	327	GV2ME22 <sup>(3)</sup>
15	10	50	18.5	4	75	22	3	75	24...32	416	GV2ME32

#### Motor circuit breakers from 0.06 to 15 kW / 400 V, with lugs

To order thermal magnetic circuit breakers with connection by lugs, add the digit **6** to the end of reference selected above.

Example: **GV2 ME08** becomes **GV2 ME086**.

#### Thermal magnetic circuit breakers GV2 ME with built-in auxiliary contact block

With instantaneous auxiliary contact block (composition, see page B6/11):

- GV AE1, add suffix **AE1TQ** to the motor circuit breaker reference selected above.  
Example: **GV2 ME01AE1TQ**.
- GV AE11, add suffix **AE11TQ** to the motor circuit breaker reference selected above.  
Example: **GV2 ME01AE11TQ**.
- GV AN11, add suffix **AN11TQ** to the motor circuit breaker reference selected above.  
Example: **GV2 ME01AN11TQ**.

These circuit breakers with built-in contact block are sold in lots of 20 units in a single pack.

(1) As % of I<sub>cu</sub>.

(2) The thermal trip setting must be within the range marked on the graduated knob.

(3) Maximum rating which can be mounted in enclosures **GV2 MC** or **MP**, please consult your Regional Sales Office.

\* > 100 kA.

# TeSys protection components

## Thermal-magnetic motor circuit breakers

### GV2 ME

## TeSys GV

DF5261.135.fr



GV2 ME●●3

DF533898.eps

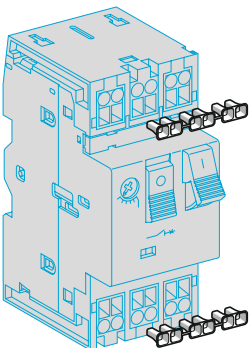

LA9 D99

#### Motor circuit breakers from 0.06 to 11 kW, with spring terminal connections

##### GV2 ME <sup>(1)</sup> with pushbutton control

Standard power ratings of 3-phase motors 50/60 Hz in category AC-3						Setting range of thermal trips <sup>(3)</sup>	Magnetic tripping current I <sub>d</sub> ± 20 %	Reference
400/415 V			500 V					
P	I <sub>cu</sub>	I <sub>cs</sub> <sup>(2)</sup>	P	I <sub>cu</sub>	I <sub>cs</sub> <sup>(2)</sup>			
kW	kA	%	kW	kA	%	A	A	
–	–	–	–	–	–	0.1...0.16	1.5	GV2ME013
0.06	*	*	–	–	–	0.16...0.25	2.4	GV2ME023
0.09	*	*	–	–	–	0.25...0.40	5	GV2ME033
0.12	*	*	–	–	–	0.40...0.63	8	GV2ME043
0.18	*	*	–	–	–	0.63...1	13	GV2ME053
0.25	*	*	0.37	*	*	1...1.6	22.5	GV2ME063
0.37	*	*	0.37	*	*	1.6...2.5	33.5	GV2ME073
0.55	*	*	0.55	*	*	2.5...4	51	GV2ME083
0.75	*	*	0.75	*	*	4...6.3	78	GV2ME103
1.1	*	*	1.1	*	*	6...10	138	GV2ME143
1.5	*	*	1.5	*	*	9...14	170	GV2ME163
2.2	*	*	3	50	100	13...18	223	GV2ME203
3	*	*	4	10	100	17...23	327	GV2ME213
4	*	*	5.5	10	100	20...25	327	GV2ME223
5.5	15	50	7.5	6	75			
7.5	15	50	9	6	75			
9	15	40	11	4	75			
11	15	40	15	4	75			
11	15	40	15	4	75			

##### Contact blocks

Description	Mounting	Maximum number	Type of contacts	Sold in lots of	Unit reference
Instantaneous auxiliary contacts	Front	1	N/O + N/C	10	GVAE113
			N/O + N/O	10	GVAE203
	LH side	2	N/O + N/C	1	GVAN113
			N/O + N/O	1	GVAN203

##### Accessory

Description	Application	Sold in lots of	Unit reference
Cable end reducer	For connection of conductors from 1 to 1.5 mm <sup>2</sup>	20	LA9D99

<sup>(1)</sup> For connection of conductors from 1 to 1.5 mm<sup>2</sup>, the use of an LA9 D99 cable end reducer is recommended.

<sup>(2)</sup> Maximum rating which can be mounted in enclosures GV2 MC or MP, please consult your Regional Sales Office

<sup>(3)</sup> The thermal trip setting must be within the range marked on the graduated knob.

\* > 100 kA.

# TeSys protection components

## Thermal-magnetic motor circuit breakers

### GV2 P, GV3 P and GV3 ME80

## TeSys GV



GV2 P10



GV3 P65



GV3 P651

#### Motor circuit breakers from 0.06 to 37 kW / 400 V

Standard power ratings of 3-phase motors  
50/60 Hz in category AC-3

400/415 V			500 V			690 V		
P	Icu	Ics <sup>(1)</sup>	P	Icu	Ics <sup>(1)</sup>	P	Icu	Ics <sup>(1)</sup>

Setting  
range  
of thermal  
trips  
<sup>(2)</sup>

Magnetic  
tripping  
current  
I<sub>d</sub> ± 20 %

Reference

kW	kA	%	kW	kA	%	kW	kA	%	A	A
----	----	---	----	----	---	----	----	---	---	---

#### GV2 P: control by rotary knob

Screw clamp terminals

–	–	–	–	–	–	–	–	–	0.1...0.16	1.5	GV2P01
0.06	*	*	–	–	–	–	–	–	0.16...0.25	2.4	GV2P02
0.09	*	*	–	–	–	–	–	–	0.25...0.40	5	GV2P03
0.12	*	*	–	–	–	0.37	*	*	0.40...0.63	8	GV2P04
0.18	*	*	–	–	–	–	–	–	–	–	–
0.25	*	*	–	–	–	0.55	*	*	0.63...1	13	GV2P05
0.37	*	*	0.37	*	*	–	–	–	1...1.6	22.5	GV2P06
0.55	*	*	0.55	*	*	0.75	*	*	–	–	–
0.75	*	*	1.1	*	*	1.5	8	100	1.6...2.5	33.5	GV2P07
1.1	*	*	1.5	*	*	2.2	8	100	2.5...4	51	GV2P08
2.2	*	*	3	*	*	4	6	100	4...6.3	78	GV2P10
3	*	*	5	50	100	5.5	6	100	6...10	138	GV2P14
5.5	*	*	7.5	42	75	9	6	100	9...14	170	GV2P16
–	–	–	–	–	–	11	6	100	–	–	–
7.5	50	50	9	10	75	15	4	100	13...18	223	GV2P20
9	50	50	11	10	75	18.5	4	100	17...23	327	GV2P21
11	50	50	15	10	75	–	–	–	20...25	327	GV2P22
15	50	50	18.5	10	75	22	4	100	24...32	416	GV2P32

#### GV3 P: control by rotary knob

Connection by EverLink® BTR screw connectors <sup>(3)</sup>

5.5	100	100	7.5	12	50	11	6	50	9...13	182	GV3P13
7.5	100	100	9	12	50	15	6	50	12...18	252	GV3P18
11	100	100	15	12	50	18.5	6	50	17...25	350	GV3P25
15	100	100	18.5	12	50	22	6	50	23...32	448	GV3P32
18.5	50	100	22	12	50	37	6	50	30...40	560	GV3P40
22	50	100	30	12	50	45	6	50	37...50	700	GV3P50
30	50	100	45	12	50	55	6	50	48...65	910	GV3P65

Connection by EverLink® BTR screw connectors, for assembly with a contactor

To assemble a **GV3 P13** to **P65** circuit breaker with an **LC1 D40A** to **D65A** contactor, it is possible to use the circuit breaker supplied without downstream EverLink® power terminal block. To order this product, add the digit **1** to the end of the references selected above. Example: **GV3 P65** becomes **GV3 P651**.

Connection by lugs

To order thermal magnetic circuit breakers with connection by lugs, add the digit **6** to the end of reference selected above. Example: **GV3 P18** becomes **GV3 P186**.

#### GV3 ME80: pushbutton control, screw clamp terminals

37	15	50	45	4	100	55	2	100	56...80		GV3ME80 <sup>(4)</sup>
----	----	----	----	---	-----	----	---	-----	---------	--	------------------------

#### Motor circuit breakers up to 50 hp / 600 V, UL 508 type E

##### GV2 <sup>(5)</sup>

To obtain a **GV2 P** motor circuit breaker, UL 508 type E, use the following with the circuit breaker:

- a "Large Spacing" adapter **GV2 GH7**.

##### GV3 <sup>(6)</sup>

To obtain a motor-circuit breaker **GV3 P**, UL 508 type E, use the following with the circuit breaker:

- a "Large Spacing" cover **GV3 G66**,
- a short-circuit signalling contact **GV AM11**.

##### GV3 with connection by lugs <sup>(6)</sup>

To obtain a motor-circuit breaker **GV3 P**, UL 508 type E, with connection by lugs, add the digit **6** to the end of reference selected above and use the following with the circuit breaker:

- two IP 20 covers **LAD 96570**,
- a short-circuit signalling contact **GV AM11**.

<sup>(1)</sup> As % of I<sub>cu</sub>.

<sup>(2)</sup> The thermal trip setting must be within the range marked on the graduated knob.

<sup>(3)</sup> BTR screws: hexagon socket head. Require use of an insulated Allen key, in compliance with local wiring regulations.

<sup>(4)</sup> Recommended for use in association with a contactor.

<sup>(5)</sup> Accessory: see page B6/13.

<sup>(6)</sup> Accessories: see page B6/17.

\* > 100 kA.

# TeSys protection components

## Thermal-magnetic motor circuit breakers

### GV7 R

## TeSys GV

DF526138.fr



GV7 RE40

DF526141.fr



GV7 RS220

#### Thermal-magnetic circuit breakers GV7 R with screw clamp terminals up to 110 kW

##### Control by rocker lever

Standard power ratings of 3-phase motors  
50/60 Hz in category AC-3

400/415 V			500 V			660/690 V			Setting range of thermal trips A	Reference	Weight kg
P	Icu	Ics <sup>(1)</sup>	P	Icu	Ics <sup>(1)</sup>	P	Icu	Ics <sup>(1)</sup>			
kW	kA	%	kW	kA	%	kW	kA	%			
7.5	36	100	9	18	100	11	8	100	12...20	GV7RE20	2.010
9	36	100	11	18	100	15	8	100			
7.5	70	100	9	50	100	11	10	100	12...20	GV7RS20	2.010
9	70	100	11	50	100	15	10	100			
9	36	100	11	18	100	15	8	100	15...25	GV7RE25	2.010
11	36	100	15	18	100	18.5	8	100			
9	70	100	11	50	100	15	10	100	15...25	GV7RS25	2.010
11	70	100	15	50	100	18.5	10	100			
18.5	36	100	18.5	18	100	22	8	100	25...40	GV7RE40	2.010
			22	18	100						
18.5	70	100	18.5	50	100	22	10	100	25...40	GV7RS40	2.010
22	36	100	30	18	100	30	8	100	30...50	GV7RE50	2.015
22	70	100	30	50	100	30	10	100	30...50	GV7RS50	2.015
37	36	100	45	18	100	55	8	100	48...80	GV7RE80	2.040
			55	18	100						
37	70	100	45	50	100	55	10	100	48...80	GV7RS80	2.040
			55	50	100						
45	36	100	–	18	100	75	8	100	60...100	GV7RE100	2.040
45	70	100	–	50	100	75	10	100	60...100	GV7RS100	2.040
55	35	100	75	30	100	90	8	100	90...150	GV7RE150	2.020
75	35	100	90	30	100	110	8	100			
55	70	100	75	50	100	90	10	100	90...150	GV7RS150	2.020
75	70	100	90	50	100	110	10	100			
90	35	100	110	30	100	160	8	100	132...220	GV7RE220	2.350
110	35	100	132	30	100	200	8	100			
			160	30	100						
90	70	100	110	50	100	160	10	100	132...220	GV7RS220	2.350
110	70	100	132	50	100	200	10	100			
			160	50	100						

(1) As % of Icu.

DF528142.fr



GV2 RT

## For motors with high current peak on starting

## Control by rocker lever

Standard power ratings of 3-phase motors 50/60 Hz in category AC-3					Setting range of thermal trips (1)	Magnetic tripping current I <sub>d</sub> ± 20 %	Reference
220/ 230 V	400/ 415 V	440 V	500 V	690 V			
kW	kW	kW	kW	kW	A	A	
0.06	0.09	0.09 0.12	–	–	0.25...0.40	8	GV2RT03
–	0.12 0.18	0.18	–	0.37	0.40...0.63	13	GV2RT04
0.09 0.12	0.25 0.37	0.25 0.37	0.37	0.55	0.63...1	22	GV2RT05
0.18 0.25	0.37 0.55	0.37 0.55	0.37 0.55 0.75	0.75 1.1	1...1.6	33	GV2RT06
0.37	0.75	0.75 1.1	1.1	1.5	1.6...2.5	51	GV2RT07
0.55 0.75	1.1 1.5	1.5	1.5 2.2	2.2 3	2.5...4	78	GV2RT08
1.1	2.2	2.2 3	3	4	4...6.3	138	GV2RT10
1.5 2.2	3 4	4	4 5.5	5.5 7.5	6...10	200	GV2RT14
2.2 3	5.5	5.5 7.5	7.5	9 11	9...14	280	GV2RT16
4	7.5	7.5 9	9	15	13...18	400	GV2RT20
5.5	9 11	11	11	18.5	17...23	400	GV2RT21

(1) The thermal trip setting must be within the range marked on the graduated knob.



# TeSys protection components

## Thermal-magnetic circuit breakers

### GV2 RT

## TeSys GV

DF526142.fr



GV2 RT

For primaries of 3-phase transformers								
Control by rocker lever								
Standard power ratings					Setting range of thermal trips <sup>(1)</sup>	Magnetic tripping current I <sub>d</sub> ± 20 %	Reference	
230/240 V	400/415 V	440 V	500 V	690 V				
kW	kW	kW	kW	kW	A	A		
–	–	–	–	–	0.25...0.40	8	GV2RT03	
–	–	–	–	–	0.40...0.63	13	GV2RT04	
–	–	0.63	0.63	1	0.63...1	22	GV2RT05	
0.4	0.63	1	1	–	1...1.6	33	GV2RT06	
0.63	1	–	1.6	1.6 2	1.6...2.5	51	GV2RT07	
1	1.6 2	1.6 2	2 2.5	2.5	2.5...4	78	GV2RT08	
1.6 2	2.5	2.5 4	4	4 5 6.3	4...6.3	138	GV2RT10	
2.5	4 5	5	5 6.3	–	6...10	200	GV2RT14	
4	6.3	6.3	–	10 12.5	9...14	280	GV2RT16	
5 6.3	10	10	10 12.5	10	13...18	400	GV2RT20	

Accessory <sup>(2)</sup>	
Description	Reference
Padlockable external operator (IP 54) black handle, blue legend plate	GV2AP03

<sup>(1)</sup> The thermal trip setting must be within the range marked on the graduated knob.

<sup>(2)</sup> Other accessories such as mounting, cabling and marking accessories are identical to those used for GV2 ME motor circuit breakers, see page B6/13.

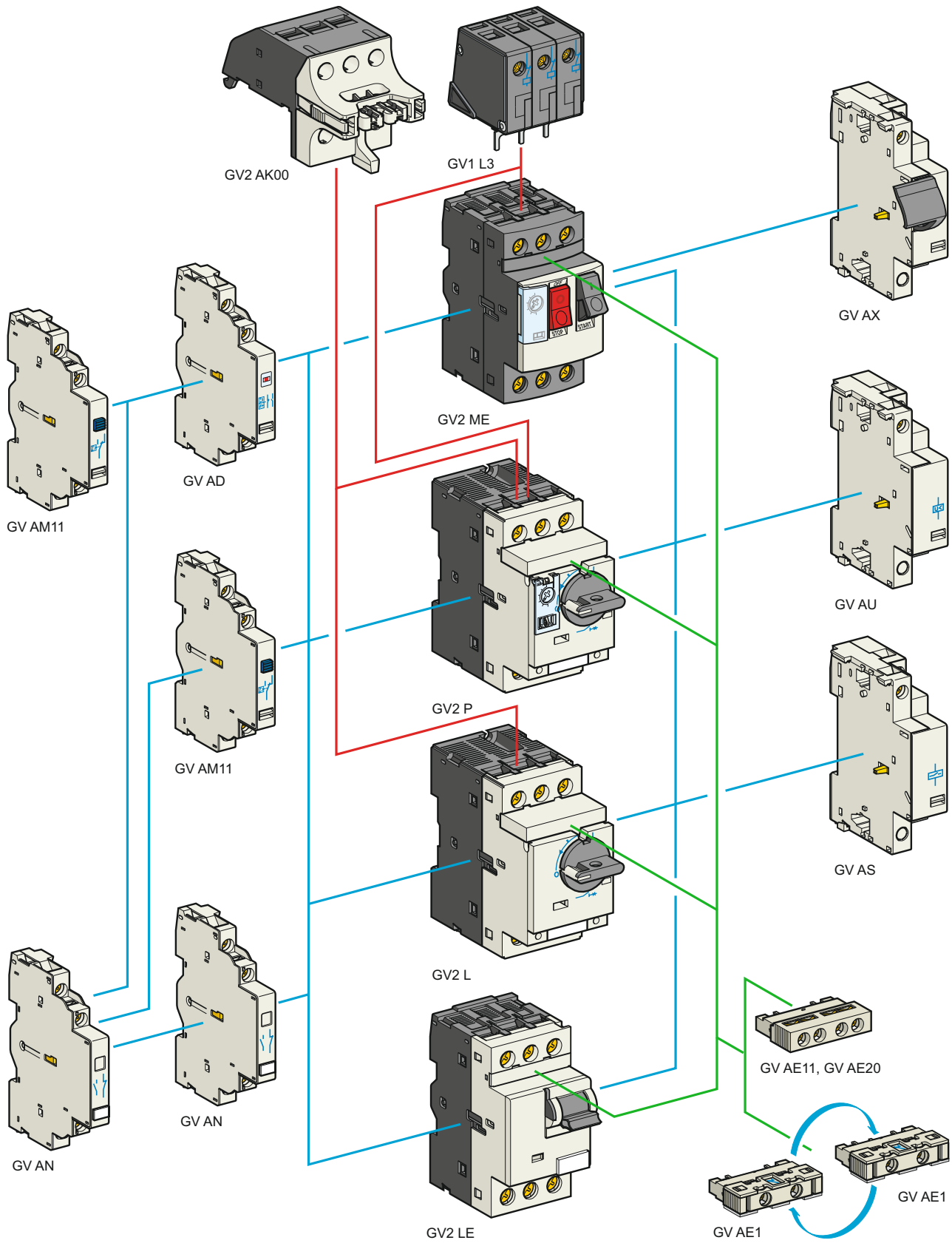

# TeSys protection components

## Thermal-magnetic and magnetic motor circuit breakers GV2 with screw clamp connections

### Add-on blocks and accessories

Contact blocks					
Description	Mounting	Maximum number	Type of contacts	Sold in lots of	Unit reference
Instantaneous auxiliary contacts	Front <sup>(1)</sup>	1	N/O or N/C <sup>(2)</sup>	10	GVAE1
			N/O + N/C	10	GVAE11
			N/O + N/O	10	GVAE20
	Side (LH)	2	N/O + N/C	1	GVAN11
			N/O + N/O	1	GVAN20
			N/O (fault) + N/O	1	GVAD1010
Fault signalling contact + instantaneous auxiliary contact	Side <sup>(3)</sup> (LH)	1	N/O (fault) + N/C	1	GVAD1001
				1	GVAD1001
			N/C (fault) + N/O	1	GVAD0110
				1	GVAD0101
Short-circuit signalling contact	Side (LH)	1	C/O common point	1	GVAM11

Electric trips			
Mounting	Voltage		Reference
<b>Undervoltage or shunt trips <sup>(4)</sup></b>			
Side (1 block on RH side of circuit breaker)	24 V	50 Hz	GVA●025
		60 Hz	GVA●026
	48 V	50 Hz	GVA●055
		60 Hz	GVA●056
	100 V	50 Hz	GVA●107
	100...110 V	60 Hz	GVA●107
	110...115 V	50 Hz	GVA●115
		60 Hz	GVA●116
	120...127 V	50 Hz	GVA●125
	127 V	60 Hz	GVA●115
	200 V	50 Hz	GVA●207
	200...220 V	60 Hz	GVA●207
	220...240 V	50 Hz	GVA●225
		60 Hz	GVA●226
	380...400 V	50 Hz	GVA●385
		60 Hz	GVA●386
	415...440 V	50 Hz	GVA●415
	415 V	60 Hz	GVA●416
	440 V	60 Hz	GVA●385
480 V	60 Hz	GVA●415	
500 V	50 Hz	GVA●505	
600 V	60 Hz	GVA●505	

#### Undervoltage trip, INRS (can only be mounted on GV2 ME) Safety device for dangerous machines conforming to INRS and VDE 0113

Side (1 block on RH side of circuit breaker GV2 ME)	110...115 V	50 Hz	GVAX115
		60 Hz	GVAX116
	127 V	60 Hz	GVAX115
	220...240 V	50 Hz	GVAX225
		60 Hz	GVAX226
	380...400 V	50 Hz	GVAX385
		60 Hz	GVAX386
	415...440 V	50 Hz	GVAX415
	440 V	60 Hz	GVAX385

#### Add-on contact blocks

Description	Mounting	Maximum number	Reference
Visible isolation block <sup>(5)</sup>	Front <sup>(1)</sup>	1	GV2AK00 <sup>(6)</sup>
Limiters	At top (GV2 ME and GV2 P)	1	GV1L3
	Independent	1	LA9LB920

- (1) Mounting of a **GV AE** contact block or a **GV2 AK00** visible isolation block on **GV2 P** and **GV2 L**.  
 (2) Choice of N/C or N/O contact operation, depending on which way round the reversible block is mounted.  
 (3) The **GV AD** is always mounted next to the circuit breaker.  
 (4) To order an undervoltage trip: replace the dot (●) in the reference with a **U**, example: **GV AU025**.  
 To order a shunt trip: replace the dot (●) in the reference with an **S**, example: **GV AS025**.  
 (5) Visible isolation of the 3 poles upstream of circuit breaker **GV2 P** and **GV2 L**.  
 Visible isolation block **GV2 AK00** cannot be used with motor circuit breakers **GV2 P32** and **GV2 L32** (Ith max = 25 A).  
 (6) Ie Max = 32 A.

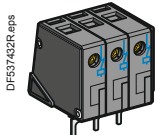

GV1L3

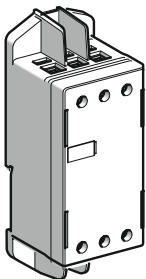

LA9LB920

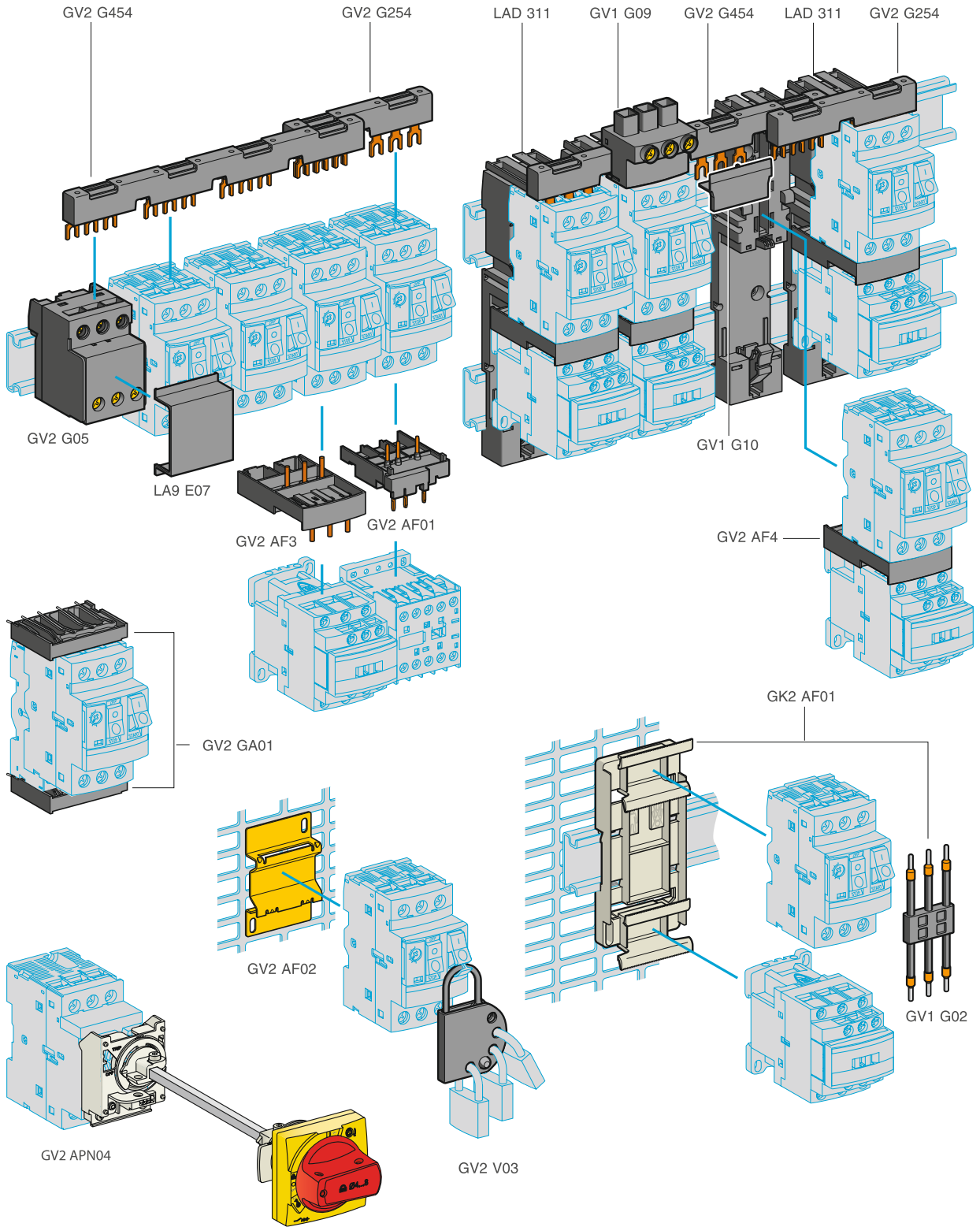

# TeSys protection components

## Thermal-magnetic and magnetic motor circuit breakers GV2 with screw clamp connections

### Accessories

## TeSys GV

Accessories			
Description	Application	Sold in lots of	Unit reference
<b>Adapter plates</b>	For mounting a GV2 ME or GV2 LE by screw fixing	10	GV2AF02
	For mounting a GV2 ME or GV2 P and contactor LC1 D09...D38 with front faces aligned	1	LAD311
<b>Height compensation plate</b>	7.5 mm	10	GV1F03
<b>Combination blocks</b>	Between GV2 and contactor LC1 K or LP1 K	10	GV2AF01
	Between GV2 and contactor LC1 D09...D38	10	GV2AF3
	Between GV2 mounted on LAD 311 and contactor LC1 D09...D38	10	GV2AF4
<b>Motor starter adapter plate</b>	With 3-pole connection for mounting a GV2 and a contactor LC1 D09...D25	1	GK2AF01
Description	Application	Pitch	Reference
<b>Sets of 3-pole 63 A busbars</b>	2 tap-offs	45 mm	GV2G245
		54 mm	GV2G254
		72 mm	GV2G272
	3 tap-offs	45 mm	GV2G345
		54 mm	GV2G354
	4 tap-offs	45 mm	GV2G445
		54 mm	GV2G454
	5 tap-offs	45 mm	GV2G472
		54 mm	GV2G554
	Description	Application	Sold in lots of
<b>Protective end cover</b>	For unused busbar outlets	5	GV1G10
<b>Terminal block</b> for supply to one or more GV2 G busbar sets	Connection from the top	1	GV1G09
	Can be fitted with current limiter GV1 L3 (GV2 ME and GV2 P)	1	GV2G05
<b>Cover for terminal block</b>	For mounting in modular panels	10	LA9E07
<b>Flexible 3-pole connection</b> for connecting a GV2 to a contactor LC1-D09...D25	Centre distance between mounting rails: 100...120 mm	10	GV1G02
<b>Set of connections</b> upstream/downstream	For connecting GV2 ME to a printed circuit board	10	GV2GA01
<b>"Large Spacing" adapter</b> UL 508 type E	For GV2 P●●H7 (except 32 A)	1	GV2GH7
<b>Clip-in marker holders</b> (supplied with each circuit breaker)	For GV2 P, GV2 L, GV2 LE and GV2 RT (8 x 22 mm)	100	LA9D92

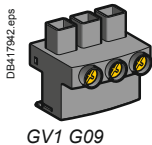

# TeSys protection components

## Thermal-magnetic and magnetic motor circuit breakers GV2 with screw clamp connections

### TeSys GV

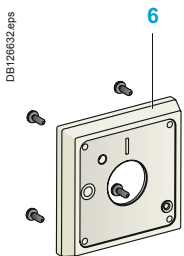
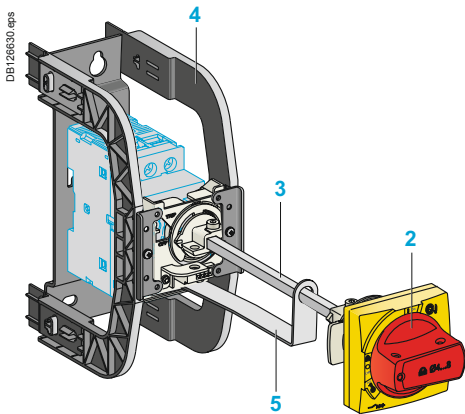
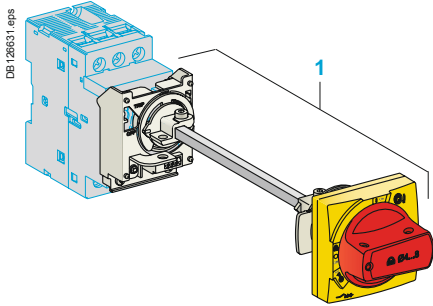

### Extended Rotary Handle

Allows a circuit breaker or a starter-controller installed in back of an enclosure to be operated from the front of the enclosure.

A rotary handle can be black or red/yellow, IP54 or IP65. It includes a function for locking the circuit breaker or the starter in the O (Off) or I (On) position (depending of the type of rotary handle) by means of up to 3 padlocks with a shank diameter of 4 to 8 mm. The extended shaft must be adjusted to use in different size enclosures. The IP54 rotary handle is fixed with a nut (Ø22) to make easier the assembling. The new Laser Square tool brings the accuracy to align the circuit breaker and the rotary handle.

### Padlockable external operators for GV2P and GV2L

#### Description

- 1 Kit handle + mounting system
- 2 Universal handle
- 3 Shaft
- 4 Bracket
- 5 Shaft support plate for deep enclosure
- 6 Retrofit accessory
- 7 Laser Square accessory

#### Kit handle + mounting system

Description	Item Reference
For GV2 P/L	
Black handle, front plate, with trip status, IP 54	1 GV2APN01
Red handle, front plate, with trip status, IP 54	1 GV2APN02
Red handle, front plate, without trip status, IP 65	1 GV2APN04
For GV2 LE	
Padlocking in "On" and "Off" position	- GV2AP03
Black handle, blue front plate, IP 54	

#### Universal handle

For GV2 P/L	
Black handle, IP 54	2 GVAPB54
Red handle, IP 54	2 GVAPR54
Red handle, IP 65	2 GVAPR65

#### Shaft

For GV2 P/L	L = 315 mm	3	GVAPA1
-------------	------------	---	--------

#### Bracket

For GV2 P/L	4	GVAPH02
-------------	---	---------

#### Shaft support plate for deep enclosure

For GV2 P/L	Depth ≥ 250 mm	5	GVAPK11
-------------	----------------	---	---------

#### Retrofit accessory

For GV2 P/L	6	GVAPP1
-------------	---	--------

#### Laser Square accessory

For GV2 P/L	7	GVAPL01
-------------	---	---------

#### Sticker

Warning label		Sold in lots of	
For French	10	-	GVAPSFR
For English	10	-	GVAPSEN
For German	10	-	GVAPSDE
For Spanish	10	-	GVAPSES
For Chinese	10	-	GVAPSCN
For Portuguese	10	-	GVAPSPT
For Russian	10	-	GVAPSRU
For Italian	10	-	GVAPSIT

### Padlocking device

Description	Reference
For all GV2 device	For use with up to 4 padlocks, Ø6 mm shank max. (padlocks not included)
	GV2V03



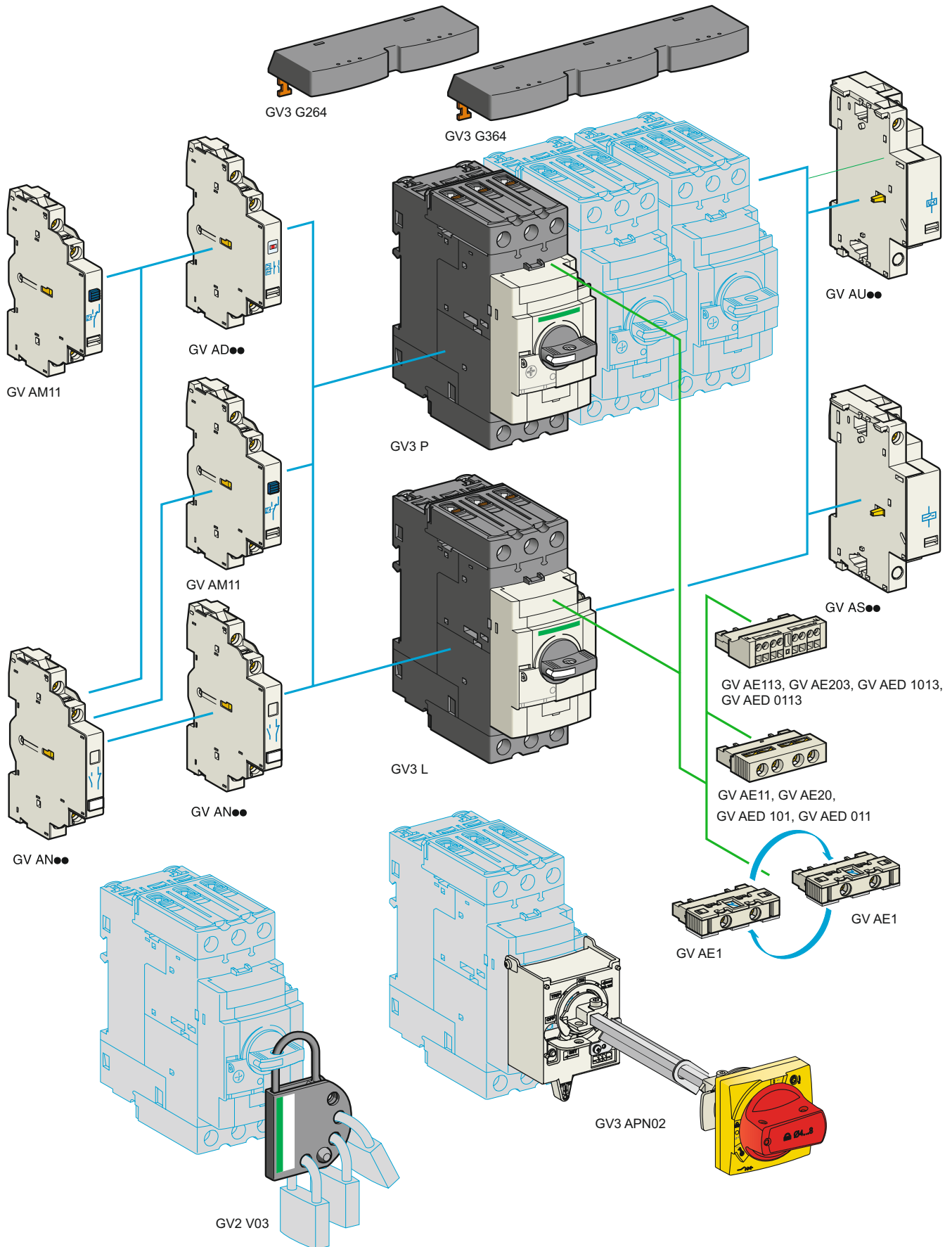



# TeSys protection components

## Thermal-magnetic motor circuit breakers

### GV3 P and GV3 L

#### Add-on blocks and accessories

## TeSys GV

DF537424.eps

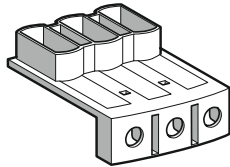

GV3 G66

### Contact blocks

Description	Mounting	Maximum number	Type of contacts	Sold in lots of	Unit reference
Instantaneous auxiliary contacts	Front	1	N/O or N/C <sup>(1)</sup>	10	GVAE1
			N/O + N/C	10	GVAE11 <sup>(2)</sup>
			N/O + N/O	10	GVAE20 <sup>(2)</sup>
Fault signalling contact + instantaneous auxiliary contact	Side (LH)	2	N/O + N/C	1	GVAN11 <sup>(2)</sup>
			N/O + N/O	1	GVAN20 <sup>(2)</sup>
			N/O (fault) + N/O	1	GVAED101 <sup>(2)</sup>
Fault signalling contact + instantaneous auxiliary contact	Front	1	N/O (fault) + N/C	1	GVAED011 <sup>(2)</sup>
			N/O (fault) + N/O	1	GVAED011 <sup>(2)</sup>
			N/O (fault) + N/O	1	GVAED011 <sup>(2)</sup>
			N/O (fault) + N/C	1	GVAED011 <sup>(2)</sup>
			N/O (fault) + N/C	1	GVAED011 <sup>(2)</sup>
Short-circuit signalling contact	Side (LH)	1	N/O (fault) + N/O	1	GVAED011 <sup>(2)</sup>
			N/O (fault) + N/C	1	GVAED011 <sup>(2)</sup>
			N/C (fault) + N/O	1	GVAED011 <sup>(2)</sup>
Short-circuit signalling contact	Side (LH)	1	C/O common point	1	GVAM11

### Electric trips - undervoltage or shunt <sup>(4)</sup>

Mounting	Voltage	Reference	
Side (1 block on RH side of circuit breaker)	24 V	50 Hz	GVA●025
		60 Hz	GVA●026
	48 V	50 Hz	GVA●055
		60 Hz	GVA●056
	100	50 Hz	GVA●107
	100...110 V	60 Hz	GVA●107
	110...115 V	50 Hz	GVA●115
		60 Hz	GVA●116
	120...127 V	50 Hz	GVA●125
	127 V	60 Hz	GVA●115
	200 V	50 Hz	GVA●207
		60 Hz	GVA●207
	200...220 V	50 Hz	GVA●225
		60 Hz	GVA●226
	380...400 V	50 Hz	GVA●385
		60 Hz	GVA●386
	415...440 V	50 Hz	GVA●415
		60 Hz	GVA●416
	440 V	60 Hz	GVA●385
	480 V	60 Hz	GVA●415
500 V	50 Hz	GVA●505	
600 V	60 Hz	GVA●505	

### Accessories

Description	Reference		
Sets of 3-pole 115 A busbars Pitch: 64 mm	2 tap-off 3 tap-off	GV3 P●● and GV3 L●● GV3 P●● and GV3 L●●	GV3G264 GV3G364
Cover "Large Spacing" UL 508 type E (Only one cover required on supply side)	GV3 P●●	GV3G66	

- (1) Choice of N/C or N/O contact operation, depending on which way round the reversible block is mounted.
- (2) Contact blocks available in version with spring terminal connections. Add a figure 3 at the end of the references selected above.  
Example: GVAED101 becomes GVAED1013.
- (3) The GVAD●● is always mounted next to the circuit breaker.
- (4) To order an undervoltage trip: replace the dot (●) in the reference with a U, example: GVAU025.  
To order a shunt trip: replace the dot (●) in the reference with an S, example: GVAS025.

# TeSys protection components

## Thermal-magnetic motor circuit breakers

### GV3 P and GV3 L

#### TeSys GV

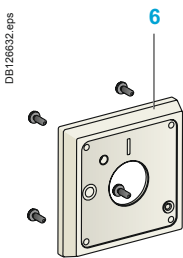
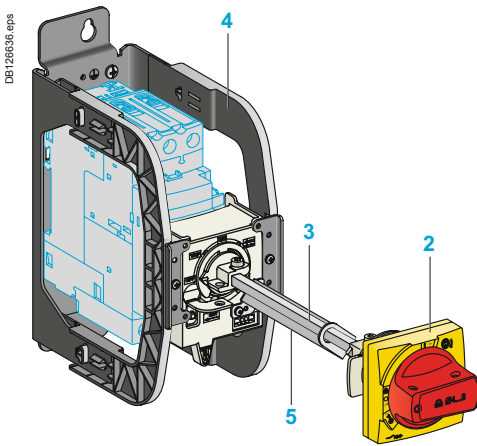
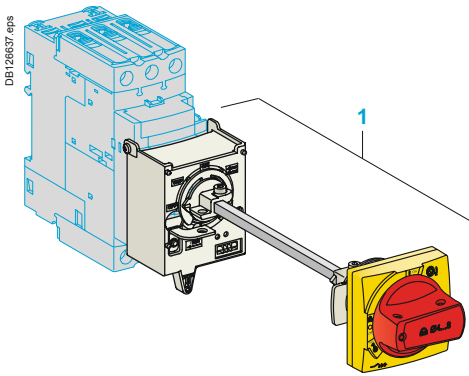

#### Extended Rotary Handle

Allows a circuit breaker or a starter-controller installed in back of an enclosure to be operated from the front of the enclosure.

A rotary handle can be black or red/yellow, IP54 or IP65. It includes a function for locking the circuit breaker or the starter in the O (Off) or I (On) position (depending of the type of rotary handle) by means of up to 3 padlocks with a shank diameter of 4 to 8 mm. The extended shaft must be adjusted to use in different size enclosures. The IP54 rotary handle is fixed with a nut (Ø22) to make easier the assembling. The new Laser Square tool brings the accuracy to align the circuit breaker and the rotary handle.

#### Padlockable external operators for GV3 and GV3L

##### Description

- 1 Kit handle + mounting system
- 2 Universal handle
- 3 Shaft
- 4 Bracket
- 5 Shaft support plate for deep enclosure
- 6 Retrofit accessory
- 7 Laser Square accessory

##### Kit handle + mounting system

Description	Item	Reference
For GV3 P/L	Black handle, front plate, with trip status, IP 54	1 GV3APN01
	Red handle, front plate, with trip status, IP 54	1 GV3APN02
	Red handle, front plate, without trip status, IP 65	1 GV3APN04

##### Universal handle

For GV3 P/L	Black handle, IP 54	2 GVAPB54
	Red handle, IP 54	2 GVAPR54
	Red handle, IP 65	2 GVAPR65

##### Shaft

For GV3 P/L	L = 315 mm	3 GVAPA1
-------------	------------	----------

##### Bracket

For GV3 P/L		4 GVAPH03
-------------	--	-----------

##### Shaft support plate for deep enclosure

For GV3 P/L	Depth ≥ 300 mm	5 GVAPK12
-------------	----------------	-----------

##### Retrofit accessory

For GV3 P/L		6 GVAPP1
-------------	--	----------

##### Laser Square accessory

For GV3 P/L		7 GVAPL01
-------------	--	-----------

Sticker	Sold in lots of		
Warning label	For French	10	- GVAPSF
	For English	10	- GVAPSE
	For German	10	- GVAPSD
	For Spanish	10	- GVAPSE
	For Chinese	10	- GVAPSC
	For Portuguese	10	- GVAPSPT
	For Russian	10	- GVAPSRU
	For Italian	10	- GVAPSIT



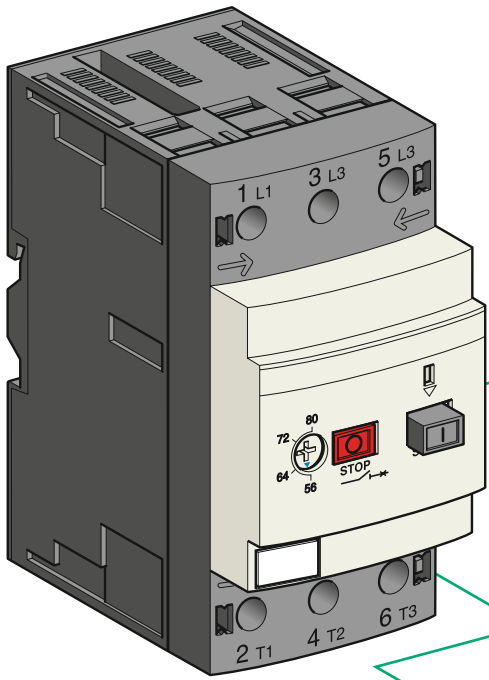

GV3 ME80

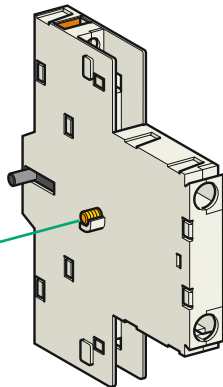

GV3 A01...A07

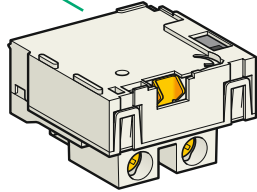

GV3 B●●  
GV3 D●●

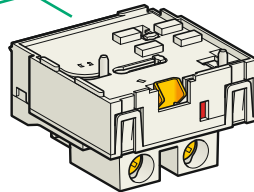

GV3 A08  
GV3 A09

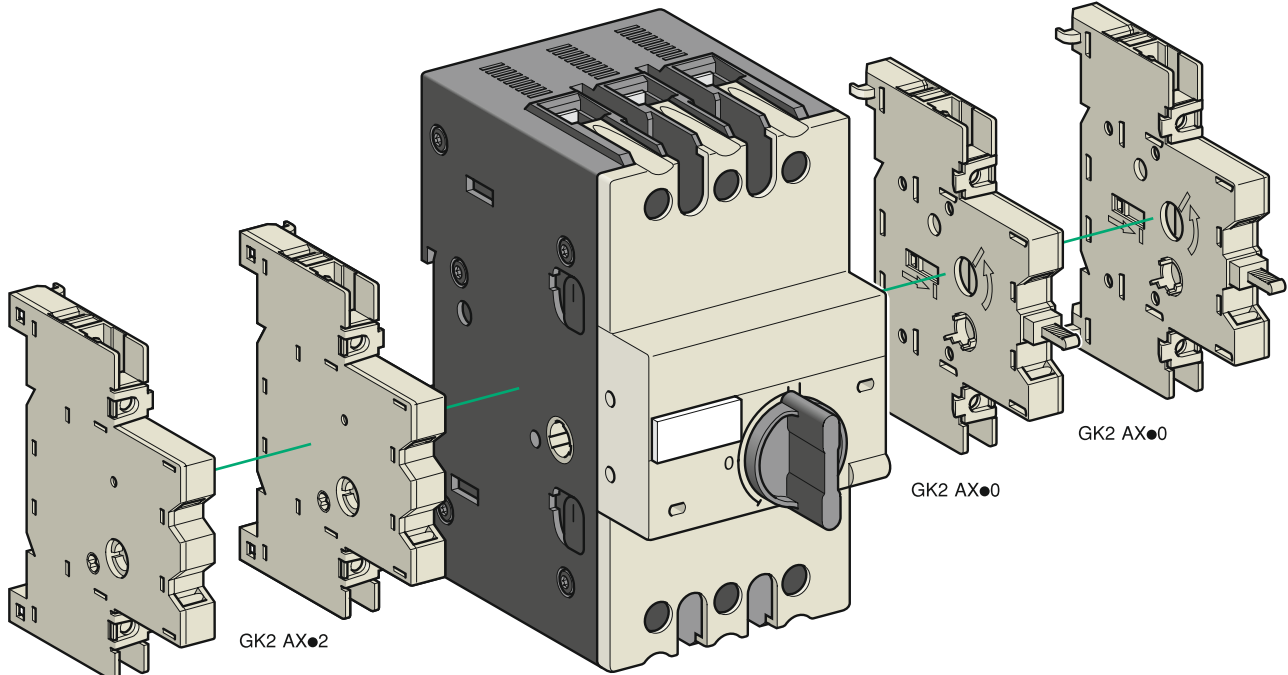

GK2 AX●2

GK3 EF80

GK2 AX●0

GK2 AX●0

# TeSys protection components

## Motor circuit breakers GV3 ME80 and GK3 EF80

### Add-on blocks and accessories

#### For thermal-magnetic motor circuit breakers GV3 ME80

##### Contact blocks

Description	Type of standard early break contacts	Reference
Instantaneous auxiliary contact blocks (1 per circuit breaker)	N/C + N/O	GV3A01
	N/O + N/O	GV3A02
	N/C + N/O + N/O	GV3A03
	N/O + N/O + N/O	GV3A05
	N/O + N/O + 2 volt-free terminals	GV3A06
	N/C + N/O + 2 volt-free terminals	GV3A07
Fault signalling contacts <sup>(1)</sup>	N/C	GV3A08
	N/O	GV3A09

##### Electric trips

Description	Voltages		Reference
	50 Hz	60 Hz	
Undervoltage trips <sup>(1)</sup>	110, 120, 127 V	120, 127 V	GV3B11
	220, 240 V	277 V	GV3B22
	380, 415 V	440 V, 480 V	GV3B38
Shunt trips <sup>(1)</sup>	110, 120, 127 V	120, 127 V	GV3D11
	220, 240 V	277 V	GV3D22
	380, 415 V	440 V, 480 V	GV3D38

##### Accessory

Description	Sold in lots of	Unit reference
Padlocking device, for locking the Start button (on open-mounted product)	5	GV1V02

#### For magnetic circuit breaker GK3 EF80

##### Contact blocks

Description	Number of poles	Reference
Auxiliary contact blocks for On-Off signalling and "control circuit test" function (1 or 2 blocks per device) mounted on RH side of GK3 EF80	N/O	GK2AX10
	N/O + N/O	GK2AX20
	N/C + N/O	GK2AX50
Instantaneous fault signalling contact blocks (1 or 2 blocks per device) mounted on LH side of GK3 EF80	N/O	GK2AX12
	N/O + N/O	GK2AX22
	N/C + N/O	GK2AX52

##### Accessories

Description	Reference
Padlocking device for padlocking the operator, using up to 3 padlocks (padlocks to be ordered separately)	GK3AV01
External operator for mounting on enclosure door. Red Ø40 knob on yellow plate, padlockable in position O (with up to 3 padlocks). Door locked when knob in position I, and when knob padlocked in position O.	GK3AP03

<sup>(1)</sup> 1 voltage trip **OR** 1 fault signalling contact to be fitted inside the motor circuit breaker.

##### Other versions

24 to 690 V, 50 or 60 Hz voltage trips for circuit breakers **GV3 ME80**. Please consult your Regional Sales Office.

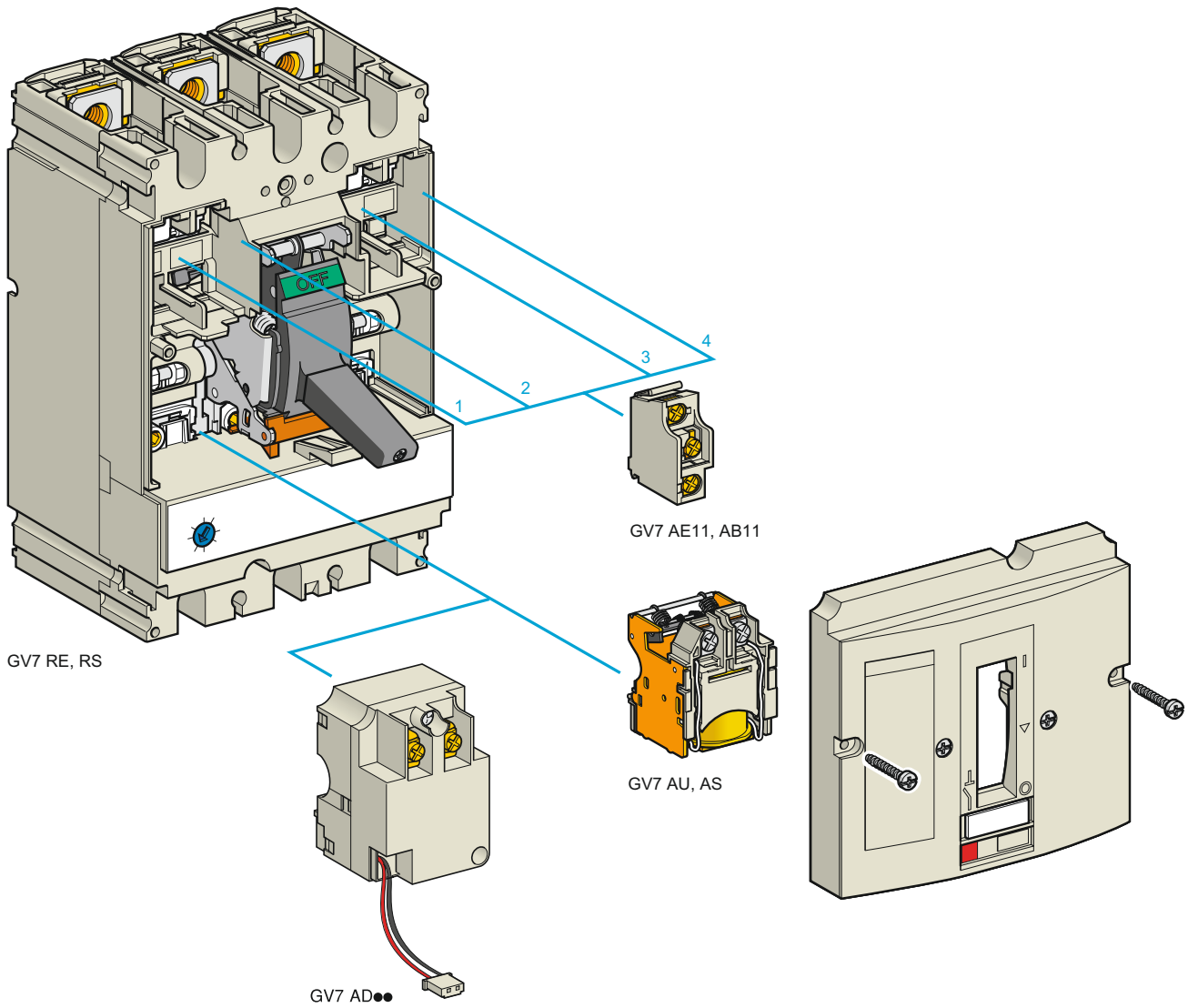

# TeSys protection components

## Thermal-magnetic motor circuit breakers

### GV7 R with screw clamp connections

#### Add-on blocks and accessories

#### Add-on auxiliary contacts

These allow remote indication of the circuit breaker contact states. They can be used for signalling, electrical locking, relaying, etc. They are available in two versions: standard and low level. They include a terminal block and the auxiliary circuits leave the circuit breaker through a hole provided for this purpose.

They perform the following functions, depending on where they are located in the circuit breaker:

Location	Function	Application
1 and/or 4	C/O contact	Indicates the position of the circuit breaker poles
2	Trip indication	Indicates that the circuit breaker has tripped due to an overload, a short-circuit, a differential fault or the operation of a voltage trip (undervoltage or shunt trip), or of the "push to trip" test button. It resets when the circuit breaker is reset.
3	Electrical fault indication	Indicates that the circuit breaker has tripped due to an overload, a short-circuit or a differential fault. It resets when the circuit breaker is reset.

Type	Reference
Standard	GV7AE11
Low level	GV7AB11

#### Fault discrimination devices

These make it possible to:

- either differentiate a thermal fault from a magnetic fault,
- or open the contactor only in the event of a thermal fault.

Voltage	Reference
~ 24...48 and ≡ 24...72 V	GV7AD111 <sup>(1)</sup>
≡ 110...240 V	GV7AD112 <sup>(1)</sup>

#### Electric trips

These allow the circuit breaker to be tripped via an electrical control signal.

- Undervoltage trip GV7 AU
  - Trips the circuit breaker when the control voltage drops below the tripping threshold, which is between 0.35 and 0.7 times the rated voltage.
  - Circuit breaker closing is only possible if the voltage exceeds 0.85 times the rated voltage.
 Circuit breaker tripping by a GV7 AU trip meets the requirements of IEC 60947-2.
- Shunt trip GV7 AS
  - Trips the circuit breaker when the control voltage rises above 0.7 times the rated voltage.
- Operation (GV7 AU or GV7 AS)
  - When the circuit breaker has been tripped by a GV7 AU or AS, it must be reset either locally or by remote control. (For remote control, please consult your Regional Sales Office).
  - Tripping has priority over manual closing: if a tripping instruction is present, manual action does not result in closing, even temporarily, of the contacts.
  - Durability: 50 % of the mechanical durability of the circuit breaker.

Type	Voltage	Reference
Undervoltage trip	48 V, 50/60 Hz	GV7AU055 <sup>(1)</sup>
	110...130 V, 50/60 Hz	GV7AU107 <sup>(1)</sup>
	200...240 V, 50/60 Hz	GV7AU207 <sup>(1)</sup>
	380...440 V, 50/60 Hz	GV7AU387 <sup>(1)</sup>
	525 V, 50 Hz	GV7AU525 <sup>(1)</sup>
Shunt trip	48 V, 50/60 Hz	GV7AS055 <sup>(1)</sup>
	110...130 V, 50/60 Hz	GV7AS107 <sup>(1)</sup>
	200...240 V, 50/60 Hz	GV7AS207 <sup>(1)</sup>
	380...440 V, 50/60 Hz	GV7AS387 <sup>(1)</sup>
	525 V, 50 Hz	GV7AS525 <sup>(1)</sup>

<sup>(1)</sup> For mounting of a GV7 AD or a GV7 AU or AS.

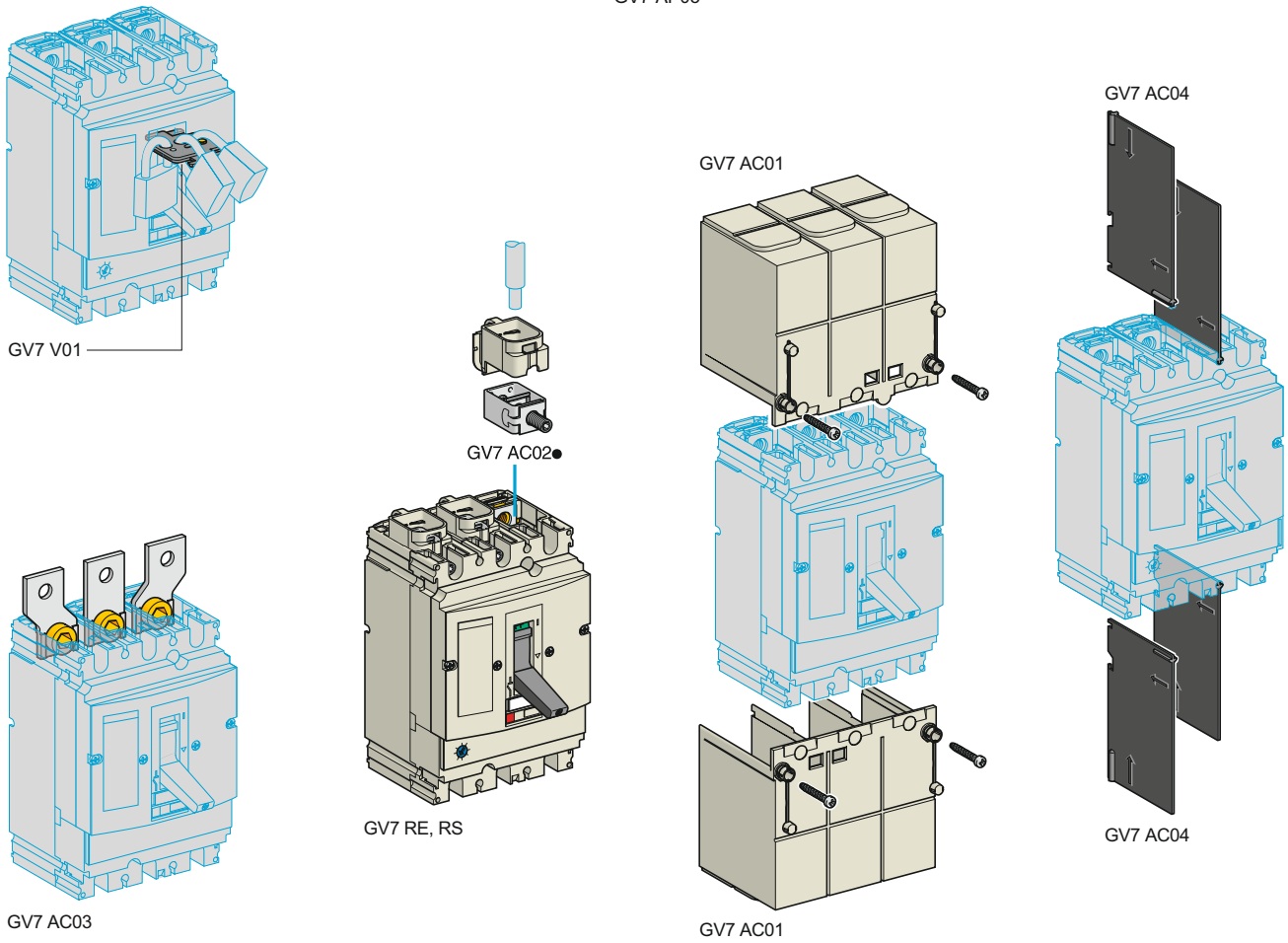
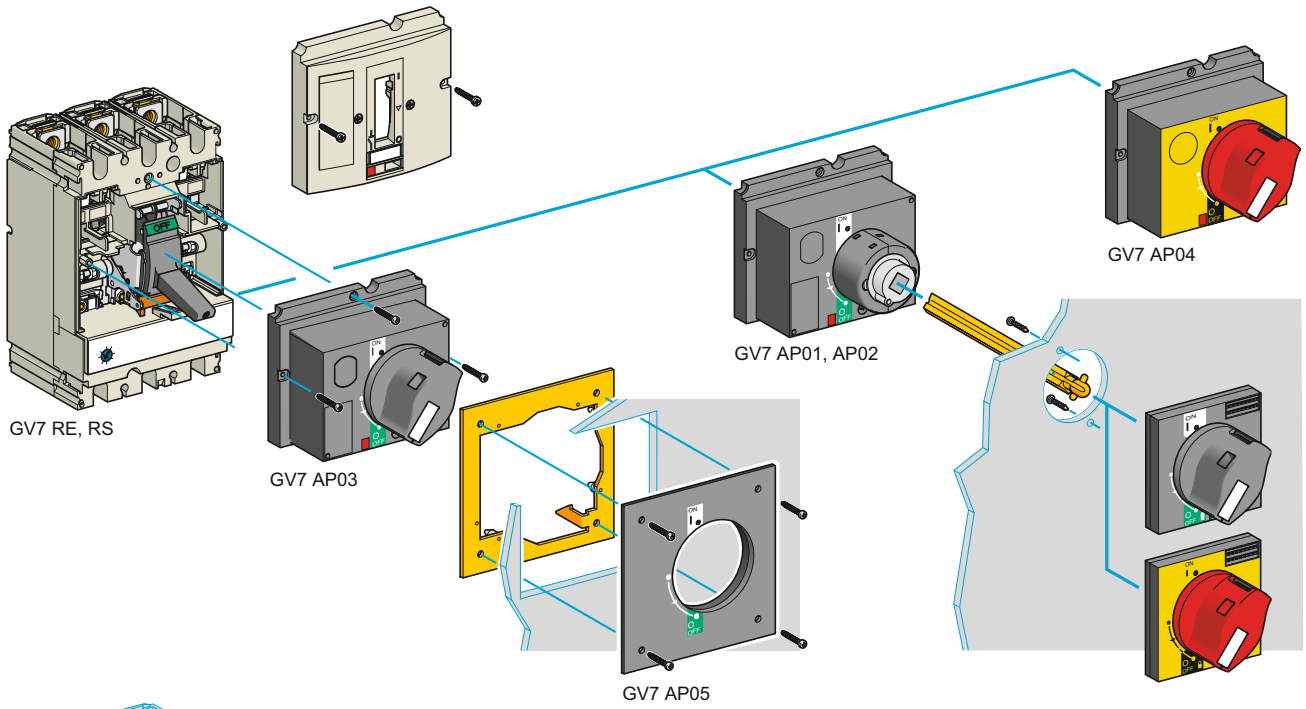



# TeSys protection components

## Thermal-magnetic motor circuit breakers

### GV7 R with screw clamp connections

#### Accessories

## TeSys GV

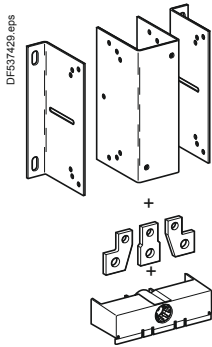

GV7 AC07

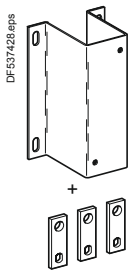

GV7 AC08

### Cabling accessories

Description	Application	For use on contactors	Sold in lots of	Unit reference
Clip-on connectors for GV7 R	Up to 150 A, 1.5...95 mm <sup>2</sup>	–	3	GV7AC021
	Up to 220 A, 1.5...185 mm <sup>2</sup>	–	3	GV7AC022
Spreader 3-pole <sup>(1)</sup>	To increase the pitch to 45 mm	–	1	GV7AC03
Terminal shields IP 405 <sup>(1)</sup>	Supplied with sealing accessory	–	1	GV7AC01
Phase barriers	Safety accessories used when fitting of shields is impossible	–	2	GV7AC04
Insulating screens	Ensure insulation between the connections and the backplate	–	2	GV7AC05
Kits for combination with contactor <sup>(2)</sup>	Allowing link between the circuit breaker and the contactor. The cover provides protection against direct finger contact	LC1 F115...F185	1	GV7AC06
		LC1 F225 and F265	1	GV7AC07
		LC1 D115 and D150	1	GV7AC08

### Direct rotary handle

Replaces the circuit breaker front cover; secured by screws. It includes a device for locking the circuit breaker in the O (Off) position by means of up to 3 padlocks with a shank diameter of 5 to 8 mm (padlocks not included). A conversion accessory allows the direct rotary handle to be mounted on the enclosure door. In this case, the door cannot be opened if the circuit breaker is in the "ON" position. Circuit breaker closing is inhibited if the enclosure door is open.

Description	Type	Degree of protection	Reference
Direct rotary handle	Black handle, black legend plate	IP 40	GV7AP03
	Red handle, yellow legend plate	IP 40	GV7AP04
Adapter plate <sup>(3)</sup>	Four mounting direct rotary handle on enclosure door	IP 43	GV7AP05

### Extended rotary handle

Allows a circuit breaker installed in the back of an enclosure to be operated from the front of the enclosure. It comprises:

- a unit which screws onto the front cover of the circuit breaker,
- an assembly (handle and front plate) to be fitted on the enclosure door,
- an extension shaft which must be adjusted (distance between the mounting surface and the door: 185 mm minimum, 600 mm maximum). It includes a device for locking the circuit breaker in the O (Off) position by means of up to 3 padlocks with a shank diameter of 5 to 8 mm (padlocks not included). This prevents the enclosure door from being opened.

Description	Type	Degree of protection	Reference
Extended rotary handle	Black handle, black legend plate	IP 55	GV7AP01
	Red handle, yellow legend plate	IP 55	GV7AP02

### Locking device

Allows circuit breakers not fitted with a rotary handle to be locked in the O (Off) position by means of up to 3 padlocks with a shank diameter of 5 to 8 mm (padlocks not included).

Description	Application	Reference
Locking device	For circuit breaker not fitted with a rotary handle	GV7V01

<sup>(1)</sup> Terminal shields cannot be used together with spreaders.

<sup>(2)</sup> The kit comprises links, a protective shield and a depth adjustable metal bracket for the breaker.

<sup>(3)</sup> This conversion accessory makes it impossible to open the door if the device is closed and prevents the device from being closed if the door is open.

# Protection components

## Thermal-magnetic circuit breakers TeSys GB2 for the protection of industrial equipment control circuits

TeSys GB

DF526243.fr



GB2 CB●●

DF526244.fr



GB2 CD●●

DF526245.fr



GB2 DB●●

### Circuit breakers with magnetic tripping threshold: 12 to 16 In

#### Single-pole

Conventional rated thermal current I <sub>th</sub> <sup>(1)</sup>	Magnetic tripping current I <sub>d</sub> ± 20 %	Sold in lots of	Unit reference
<b>A</b>	<b>A</b>		
0.5	6.6	6	GB2CB05
1	14	6	GB2CB06
2	26	6	GB2CB07
3	40	6	GB2CB08
4	52	6	GB2CB09
5	66	6	GB2CB10
6	83	6	GB2CB12
8	108	6	GB2CB14
10	138	6	GB2CB16
12	165	6	GB2CB20
16	220	6	GB2CB21
20	270	6	GB2CB22

#### Single-pole + neutral

Conventional rated thermal current I <sub>th</sub> <sup>(1)</sup>	Magnetic tripping current I <sub>d</sub> ± 20 %	Sold in lots of	Unit reference
<b>A</b>	<b>A</b>		
0.5	6.6	6	GB2CD05
1	14	6	GB2CD06
2	26	6	GB2CD07
3	40	6	GB2CD08
4	52	6	GB2CD09
5	66	6	GB2CD10
6	83	6	GB2CD12
8	108	6	GB2CD14
10	138	6	GB2CD16
12	165	6	GB2CD20
16	220	6	GB2CD21
20	270	6	GB2CD22

#### 2-pole

Conventional rated thermal current I <sub>th</sub> <sup>(1)</sup>	Magnetic tripping current I <sub>d</sub> ± 20 %	Sold in lots of	Unit reference
<b>A</b>	<b>A</b>		
0.5	6.6	3	GB2DB05
1	14	3	GB2DB06
2	26	3	GB2DB07
3	40	3	GB2DB08
4	50	3	GB2DB09
5	66	3	GB2DB10
6	83	3	GB2DB12
8	108	3	GB2DB14
10	138	3	GB2DB16
12	165	3	GB2DB20
16	220	3	GB2DB21
20	270	3	GB2DB22

(1) Conforming to IEC 60947-1.

# Protection components

## Thermal-magnetic circuit breakers TeSys GB2 for the protection of industrial equipment control circuits

TeSys GB

### Circuit breakers with magnetic tripping threshold: 5 to 7 In

DF529246.fr



GB2 CS●●

Single-pole			
Conventional rated thermal current I <sub>th</sub> <sup>(1)</sup>	Magnetic tripping current I <sub>d</sub> ± 20 %	Sold in lots of	Unit reference
A	A		
0.5	3.3	6	GB2CS05
1	6	6	GB2CS06

(1) Conforming to IEC 60947-1.

### Accessories for circuit breakers GB2-CB, DB and CS

Description	Sold in lots of	Unit reference
Busbar set for supply to 10 GB2 DB or 20 GB2 CB or GB2 CS with 2 connectors	1	GB2G210
Supply connector	10	GB2G01



## Technical Data for Designers

### Contents

#### Magnetic motor circuit breakers - TeSys GV:

- > characteristics.....B6/30 to B6/33
- > curves.....B6/34 to B6/42
- > dimensions.....B6/43 to B6/47
- > schemes.....B6/48

#### Thermal magnetic motor circuit breakers - TeSys GV:

- > presentation.....B6/49 and B6/50
- > characteristics.....B6/51 to B6/56
- > curves.....B6/57 to B6/69
- > dimensions.....B6/70 to B6/81
- > schemes.....B6/82 and B6/83

#### Thermal magnetic motor circuit breakers - TeSys GB:

- > presentation and selection.....B6/84
- > characteristics.....B6/85 to B6/87
- > dimensions and schemes.....B6/88

Auxiliary contacts characteristics.....B6/89 to B6/94

# TeSys protection components

## Magnetic motor circuit breakers

### GV2 LE and GV2 L

#### TeSys GV

Environment						
Circuit breaker type		GV2 LE		GV2 L		
Conforming to standards				IEC 60947-1, 60947-2, EN 60204, NF C 63-650, NF C63-120, 79-130, VDE 0113, 0660.		
Product certifications		CSA, CCC		CSA, CCC, BV, DNV, GL, LROS, RINA		
Protective treatment		"TH"		"TH"		
Shock resistance	Conforming to IEC 60068-2-27	30 gn		30 gn		
Vibration resistance	Conforming to IEC 60068-2-6	5 gn (5 to 150 Hz)		5 gn (5 to 150 Hz)		
Ambient air temperature	Storage	°C	-40...+80		-40...+80	
	Operation	°C	-20...+60		-20...+60	
Flame resistance	Conforming to IEC 60695-2-1	°C	960		960	
Maximum operating altitude		m	2000		2000	
Operating position						
Connection (Max. number of conductors x c.s.a)	Solid cable	mm <sup>2</sup>	<b>Min.</b> 2 x 1	<b>Max.</b> 2 x 6	<b>Min.</b> 2 x 1	<b>Max.</b> 2 x 6
	Flexible cable without cable end	mm <sup>2</sup>	2 x 1.5	2 x 6	2 x 1.5	2 x 6
	Flexible cable with cable end	mm <sup>2</sup>	2 x 1	2 x 4	2 x 1	2 x 4
Tightening torque		N.m	1.7		1.7	
Suitable for isolation	Conforming to IEC 60947-1 § 7-1-6		Yes		Yes	
Resistance to mechanical impact		J	0.5		0.5	
Technical characteristics						
Utilisation category	Conforming to IEC 60947-2		A		A	
	Conforming to IEC 60947-4-1		AC-3		AC-3	
Rated operational voltage (U <sub>e</sub> )	Conforming to IEC 60947-2	V	690		690	
Rated insulation voltage (U <sub>i</sub> )	Conforming to IEC 60947-2	V	690		690	
Rated operational frequency	Conforming to IEC 60947-2	Hz	50/60		50/60	
Rated impulse withstand voltage (U <sub>imp</sub> )	Conforming to IEC 60947-2	kV	6		6	
Total power dissipated per pole		W	1.8		1.8	
Mechanical durability (C.O.: Closing, Opening)	For AC-3 duty	C.O.	100 000		100 000	
Electrical durability for AC-3/415V duty (C.O.: Closing, Opening)		C.O.	100 000		100 000	
Duty class (maximum operating rate)		C.O./h	40		40	
Rated duty	Conforming to IEC 60947-4-1		Continuous duty		Continuous duty	

# TeSys protection components

## Magnetic motor circuit breakers

### GV2 LE and GV2 L

#### TeSys GV

Circuit breaker type				GV2 LE										GV2 L										
				03 to 06	07	08	10	14	16	20	22	32	03 to 05	06 & 07	08	10	14	16	20	22	32			
Rating			A	0.4 to 1.6	2.5	4	6.3	10	14	16	18	25	32	0.4 to 1	1.6 to 2.5	4	6.3	10	14	16	18	25	32	
Breaking capacity conforming to IEC 60947-2	230/240 V	Icu	kA	*	*	*	*	*	*	*	*	50	50	*	*	*	*	*	*	*	*	50	50	
		Ics % <sup>(1)</sup>		*	*	*	*	*	*	*	*	100	100	*	*	*	*	*	*	*	*	100	100	
400/415 V	Icu	kA	*	*	*	*	*	15	15	15	10	10	10	*	*	*	*	*	*	*	50	50	50	50
	Ics % <sup>(1)</sup>		*	*	*	*	*	50	50	40	50	50	50	*	*	*	*	*	*	*	50	50	50	50
440 V	Icu	kA	*	*	*	50	15	8	8	6	6	6	6	*	*	*	*	*	*	*	20	20	20	20
	Ics % <sup>(1)</sup>		*	*	*	100	100	50	50	50	50	50	50	*	*	*	*	*	*	*	75	75	75	75
500 V	Icu	kA	*	*	*	50	10	6	6	4	4	4	4	*	*	*	*	*	*	*	10	10	10	10
	Ics % <sup>(1)</sup>		*	*	*	100	100	75	75	75	75	75	75	*	*	*	*	*	*	*	100	75	75	75
690 V	Icu	kA	*	3	3	3	3	3	3	3	3	3	3	*	4	4	4	4	4	4	4	4	4	4
	Ics % <sup>(1)</sup>		*	75	75	75	75	75	75	75	75	75	75	*	100	100	100	100	100	100	100	100	100	100
Associated fuses (if required) if Ics > breaking capacity Icu conforming to IEC 60947-2 amendment 1	230/240 V	aM	A	*	*	*	*	*	*	*	80	80	80	*	*	*	*	*	*	*	*	100	100	
		gG	A	*	*	*	*	*	*	*	100	100	100	*	*	*	*	*	*	*	*	125	125	
400/415 V	aM	A	*	*	*	*	*	63	63	80	80	80	80	*	*	*	*	*	*	*	80	100	100	100
	gG	A	*	*	*	*	*	80	80	100	100	100	100	*	*	*	*	*	*	*	100	125	125	125
440 V	aM	A	*	*	*	50	50	50	50	63	63	63	63	*	*	*	*	*	*	*	50	63	80	80
	gG	A	*	*	*	63	63	63	63	80	80	80	80	*	*	*	*	*	*	*	63	80	100	100
500 V	aM	A	*	*	*	50	50	50	50	50	50	50	50	*	*	*	*	*	*	*	50	50	50	50
	gG	A	*	*	*	63	63	63	63	63	63	63	63	*	*	*	*	*	*	*	63	63	63	63
690 V	aM	A	*	16	25	32	32	40	40	40	40	40	40	*	20	25	40	40	40	40	50	50	50	50
	gG	A	*	20	32	40	40	50	50	50	50	50	50	*	25	32	50	50	50	50	63	63	63	63
Cable protection against thermal stress in the event of short-circuit (PVC insulated copper cables) Minimum c.s.a. protected at 40 °C and at Ics max.	1 mm <sup>2</sup>	kA	●	●	●	≤10	≤6	(2)	(2)	(2)	(2)	(2)	(2)	●	●	●	●	●	●	●	≤10	≤6	(2)	(2)
	1.5 mm <sup>2</sup>	kA	●	●	●	≤20	≤10	(2)	(2)	(2)	(2)	(2)	(2)	●	●	●	●	●	●	●	≤20	≤10	(2)	(2)
	2.5 mm <sup>2</sup>		●	●	●	●	●	●	●	●	●	●	(2)	●	●	●	●	●	●	●	●	●	●	(2)
	4...6 mm <sup>2</sup>		●	●	●	●	●	●	●	●	●	●	●	●	●	●	●	●	●	●	●	●	●	●

\* > 100 kA.  
 ● Cable c.s.a. protected.  
 (1) As % of Icu.  
 (2) Cable c.s.a. not protected.

# TeSys protection components

## Magnetic motor circuit breakers

### GV3 L

#### TeSys GV

Environment							
<b>Circuit breaker type</b>		<b>GV3 L</b>					
Conforming to standards		IEC/EN 60947-1, 60947-2					
Protective treatment		"TH"					
Degree of protection (front face)	Conforming to IEC 60529	IP20 against finger direct contact					
Shock resistance	Conforming to IEC 60068-2-27	On : 15 gn -11 ms Off : 30 gn -11 ms					
Vibration resistance	Conforming to IEC 60068-2-6	4 gn (5...300 Hz)					
Flame resistance	Conforming to IEC 60695-2-1	°C	960				
Ambient air temperature	Storage	°C	-40...+80				
	Operation	°C	-20...+60 <sup>(1)</sup>				
Maximum operating altitude		m	3000				
Operating position	Without derating, in relation to normal vertical mounting plane <sup>(2)</sup>						
Connection (Max. number of conductors x c.s.a)	Solid cable	mm <sup>2</sup>	<table border="1"> <thead> <tr> <th>Min.</th> <th>Max.</th> </tr> </thead> <tbody> <tr> <td>2 x 1</td> <td>1 x 25 1 x 35</td> </tr> </tbody> </table>	Min.	Max.	2 x 1	1 x 25 1 x 35
	Min.	Max.					
	2 x 1	1 x 25 1 x 35					
Flexible cable without cable end	mm <sup>2</sup>	2 x 1	1 x 25 1 x 35				
Flexible cable with cable end	mm <sup>2</sup>	2 x 1	1 x 25 1 x 35				
Tightening torque		N.m	5 5 : 25 mm <sup>2</sup> 8 : 35 mm <sup>2</sup>				
Suitable for isolation conforming to IEC 60947-1 § 7-1-6			Yes				

Technical characteristics			
Rated insulation voltage (Ui)	Conforming to IEC 60947-2	V	690
Rated impulse withstand voltage (U imp)	Conforming to IEC 60947-2	kV	6
Rated operational voltage (Ue)	Conforming to IEC 60947-2	V	690
Rated operational frequency		Hz	50/60
Electrical durability for AC-3/415V duty (C.O.: Close - Open)		C.O.	50 000
Mechanical durability (C.O.: Closing, Opening)		C.O.	50 000
Maximum operating rate		C.O./h	25
Operating threshold of magnetic trips			14 I max
Utilisation category	Conforming to IEC 60947-2		A

- <sup>(1)</sup> Leave a space of 9 mm between 2 circuit breakers: either an empty space or side-mounting add-on contact blocks. Side by side mounting is possible up to 40 °C.  
<sup>(2)</sup> When mounting on a vertical rail, fit a stop to prevent any slippage.



# TeSys protection components

## Magnetic motor circuit breakers

### GV3 L

#### TeSys GV

Breaking capacity of GV3 L									
Type				GV3 L25	GV3 L32	GV3 L40	GV3 L50	GV3 L65	
Breaking capacity of the circuit-breaker only or of the circuit-breaker combined with a thermal overload relay	230/240 V	Icu	kA	100	100	100	100	100	
		Ics % <sup>(1)</sup>		100	100	100	100	100	
	400/415 V	Icu	kA	100	100	50	50	50	
		Ics % <sup>(1)</sup>		100	100	100	100	100	
	440 V	Icu	kA	50	50	50	50	50	
		Ics % <sup>(1)</sup>		100	100	100	100	100	
500 V	Icu	kA	12	12	12	12	12		
	Ics % <sup>(1)</sup>		50	50	50	50	50		
690 V	Icu	kA	6	6	6	6	6		
	Ics % <sup>(1)</sup>		50	50	50	50	50		
Associated fuses (if required) for use with circuit breaker only or circuit breaker combined with a thermal overload relay if Isc > breaking capacity	230/240 V	aM	A	*	*	*	*	*	
		gG	A	*	*	*	*	*	
	415 V	aM	A	*	*	*	*	125	
		gG	A	*	*	*	*	160	
	440 V	aM	A	63	80	125	125	125	
		gG	A	80	100	160	160	160	
	500 V	aM	A	63	63	63	63	80	
		gG	A	80	80	80	80	100	
	690 V	aM	A	50	50	50	50	63	
		gG	A	63	63	63	63	80	
	Use of circuit breakers without fuses				Minimum cable length (in metres) limiting the maximum short-circuit current to 35 kA maximum, so enabling breakers <b>GK3 EF80</b> to be used without fuses				
		Cable c.s.a.		mm <sup>2</sup>	≤ 25	35	50	70	95
Isc (rms) 3-phase, incoming (Ue = 415 V)	50 kA	m	5	6	8	10	13		
	45 kA	m	5	5	7	8	10		
	40 kA	m	5	5	5	5	8		
	37 kA	m	5	5	5	5	5		

\* Fuse not required: breaking capacity Icn > Isc.  
 (1) As % of Icu.

**Tripping curves for GV2 L or LE combined with thermal overload relay LRD or LR2 K**

Average operating times at 20 °C related to multiples of the setting current

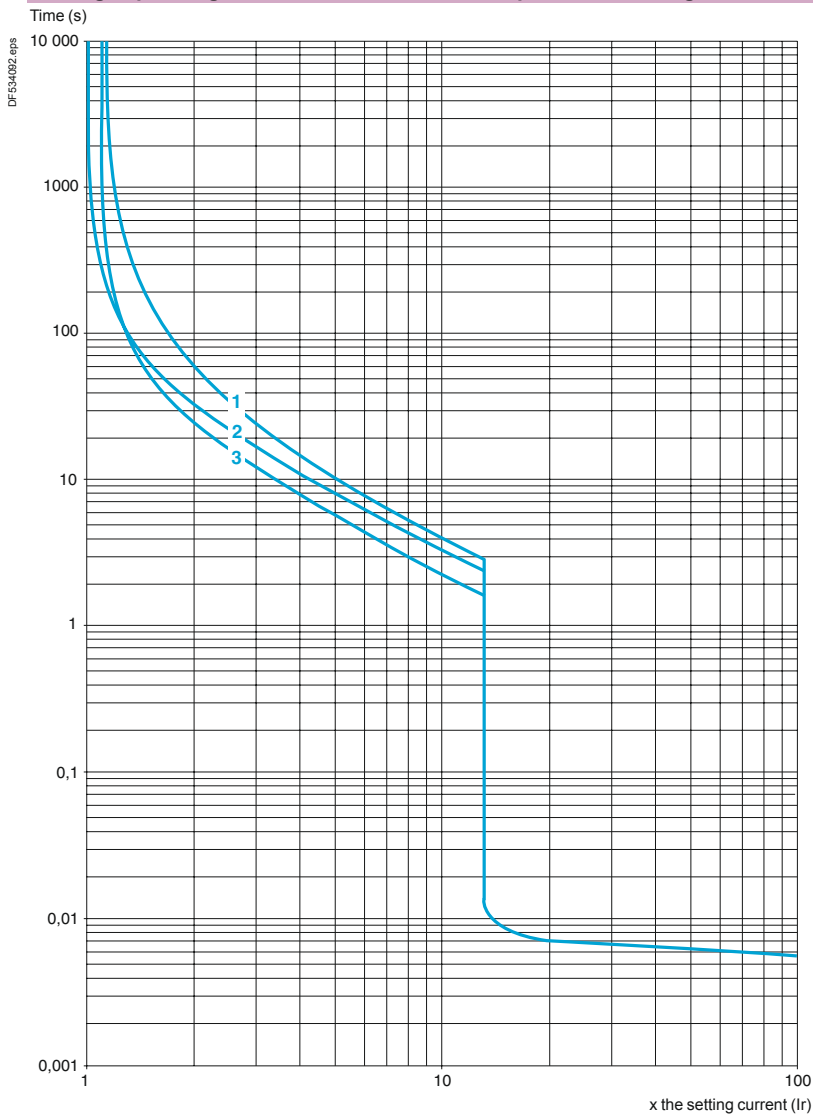

- 1 3 poles from cold state
- 2 2 poles from cold state
- 3 3 poles from hot state

## Current limitation on short-circuit for GV2 L and GV2 LE only (3-phase 400/415 V)

## Dynamic stress

$I_{peak} = f(\text{prospective } I_{sc})$  at  $1.05 U_e = 435 \text{ V}$

Limited peak current (kA)

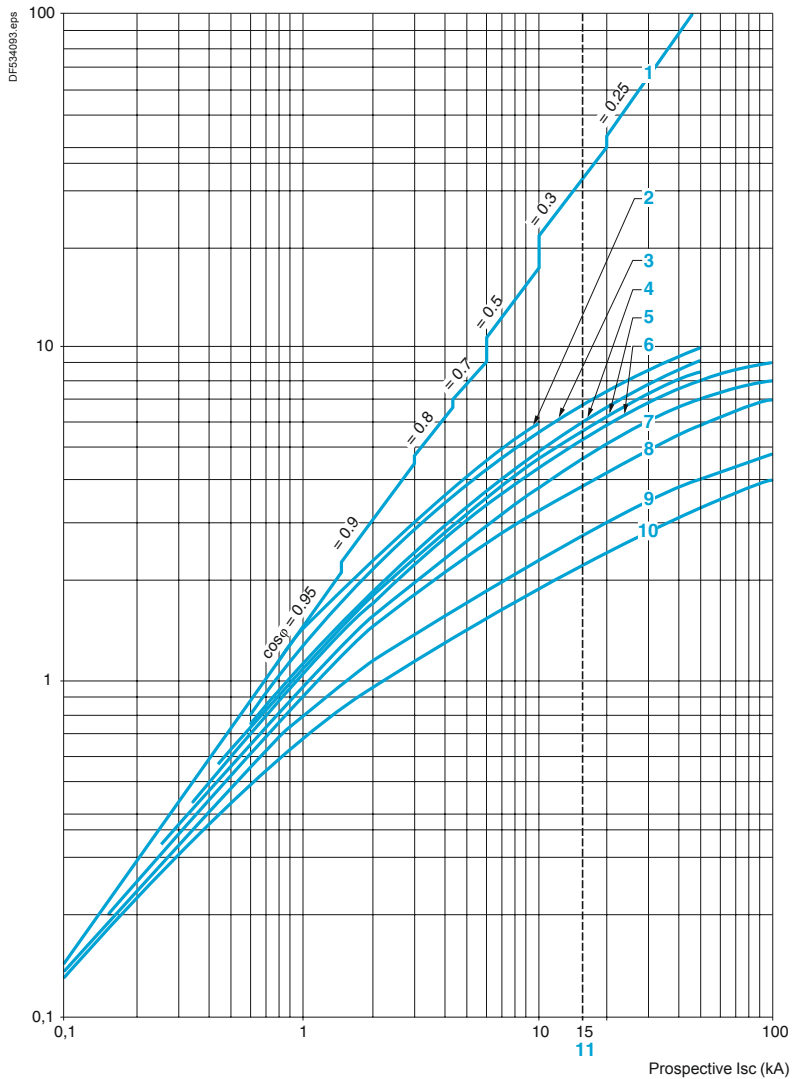

1 Maximum peak current

2 32 A

3 25 A

4 18 A

5 14 A

6 10 A

7 6.3 A

8 4 A

9 2.5 A

10 1.6 A

11 Limit of rated ultimate breaking capacity on short-circuit of GV2 LE (14, 18, 23 and 25 A ratings).

**Current limitation on short-circuit for GV2 L and GV2 LE + thermal overload relay LRD or LR2 K (3-phase 400/415 V)**

**Dynamic stress**

$I_{peak} = f(\text{prospective } I_{sc}) \text{ at } 1.05 U_e = 435 \text{ V}$

Limited peak current (kA)

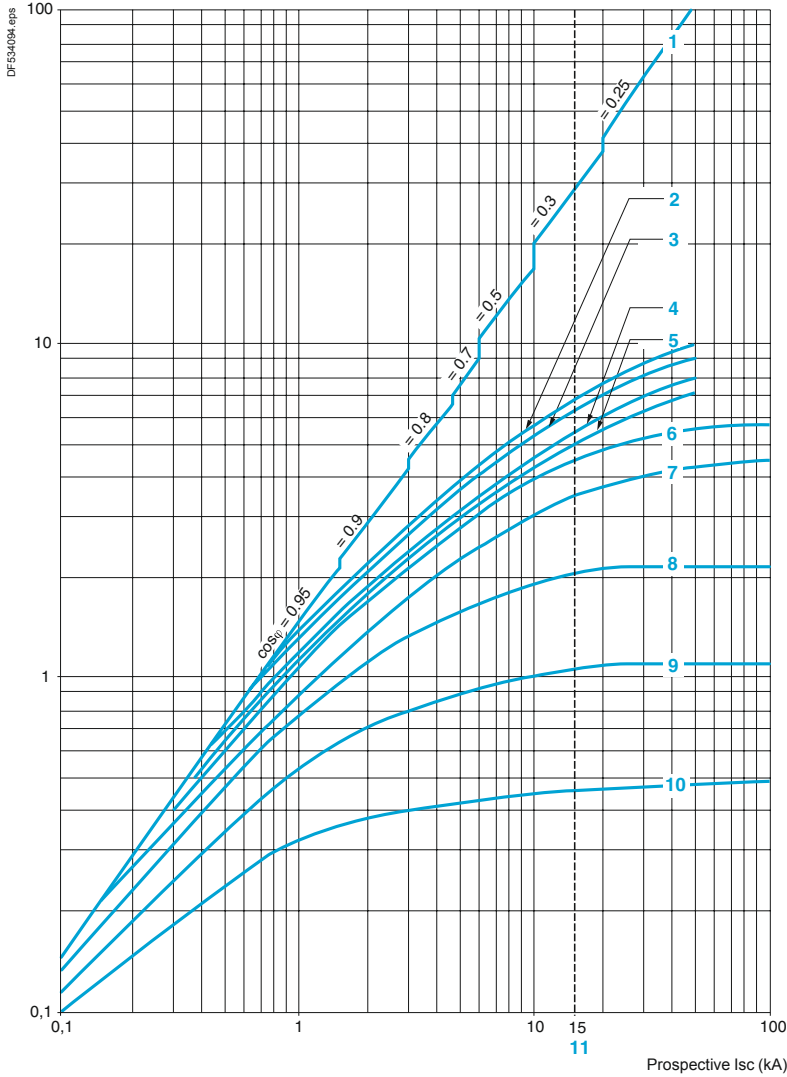

1 Maximum peak current

2 32 A

3 25 A

4 18 A

5 14 A

6 10 A

7 6.3 A

8 4 A

9 2.5 A

10 1.6 A

11 Limit of rated ultimate breaking capacity on short-circuit of GV2 LE (14, 18, 23 and 25 A ratings).

**Thermal limit on short-circuit for GV2 LE only**

**Thermal limit in kA<sup>2</sup>s in the magnetic operating zone**

Sum of  $I^2dt = f$  (prospective  $I_{sc}$ ) at 1.05  $U_e = 435$  V

Sum of  $I^2dt$  (kA<sup>2</sup>s)

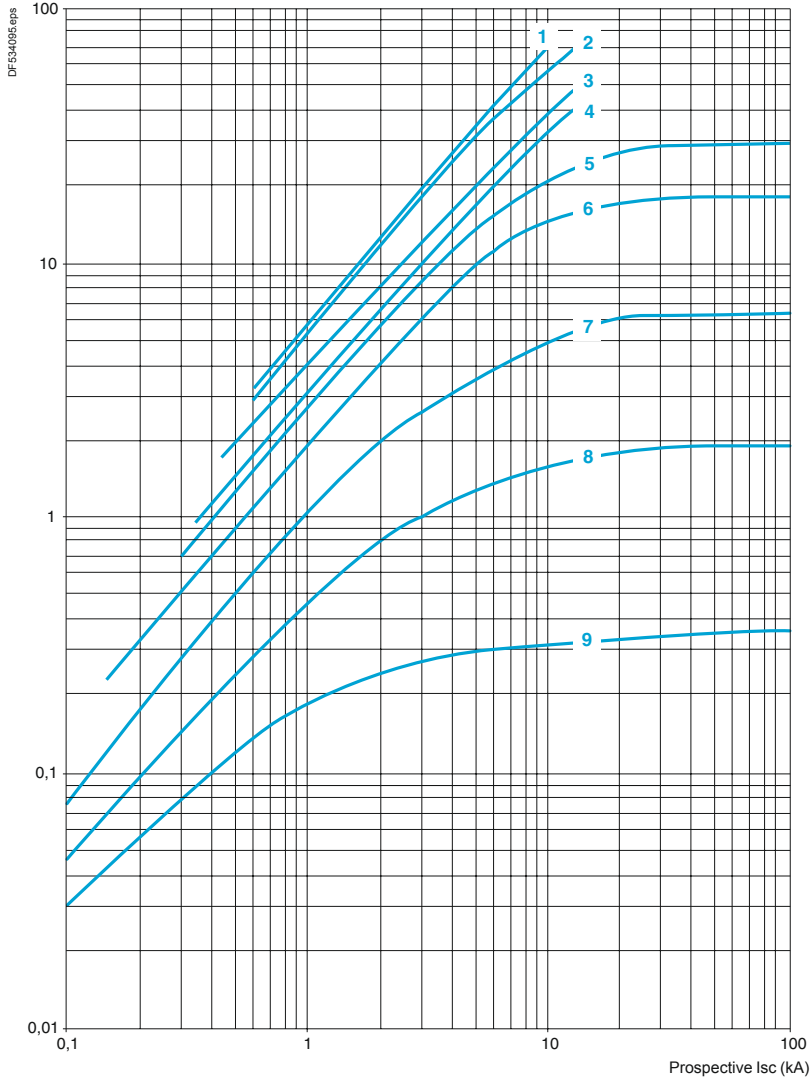

- 1 32 A
- 2 25 A
- 3 18 A
- 4 14 A
- 5 10 A
- 6 6.3 A
- 7 4 A
- 8 2.5 A
- 9 1.6 A

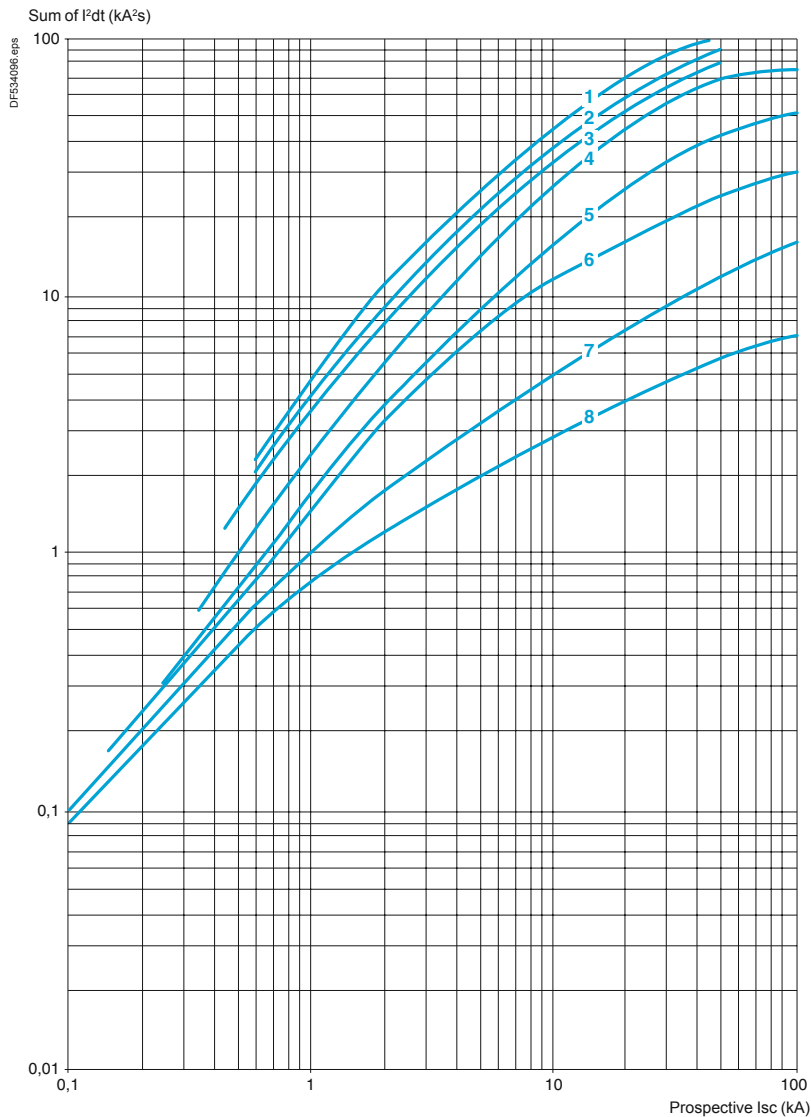
**Thermal limit on short-circuit for GV2 L only****Thermal limit in kA<sup>2</sup>s in the magnetic operating zone**Sum of I<sup>2</sup>dt = f (prospective I<sub>sc</sub>) at 1.05 U<sub>e</sub> = 435 V

- 1 25 A and 32 A
- 2 18 A
- 3 14 A
- 4 10 A
- 5 6.3 A
- 6 4 A
- 7 2.5 A
- 8 1.6 A

## Thermal limit on short-circuit for GV2 L and GV2 LE + thermal overload relay LRD or LR2 K

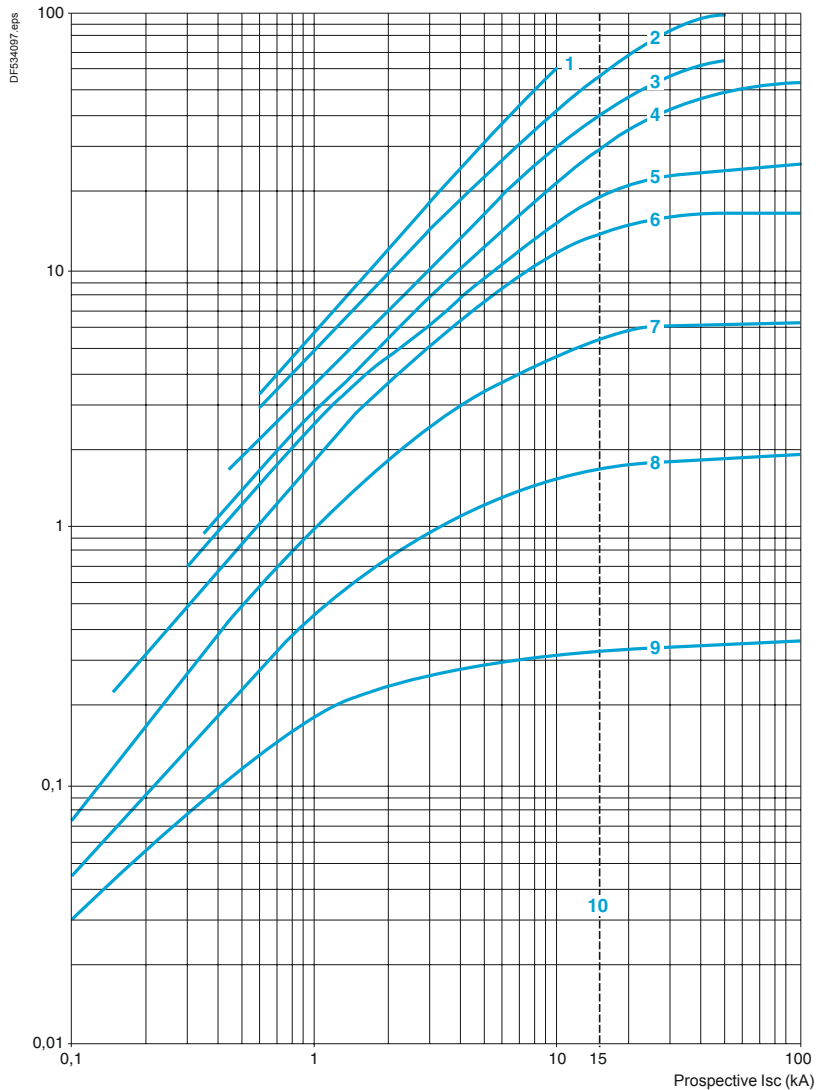
Thermal limit in  $\text{kA}^2\text{s}$  in the magnetic operating zoneSum of  $I^2dt = f$  (prospective  $I_{sc}$ ) at  $1.05 U_e = 435 \text{ V}$ Sum of  $I^2dt$  ( $\text{kA}^2\text{s}$ )

- 1 32 A (GV2 LE32)
- 2 25 A and 32 A (GV2 L32)
- 3 18 A
- 4 14 A
- 5 10 A
- 6 6.3 A
- 7 4 A
- 8 2.5 A
- 9 1.6 A
- 10 Limit of rated ultimate breaking capacity on short-circuit of GV2 LE (14, 18, 23 and 25 A ratings).

## Tripping curves for GV3 L combined with thermal overload relay LRD 33

Average operating time at 20 °C without prior current flow

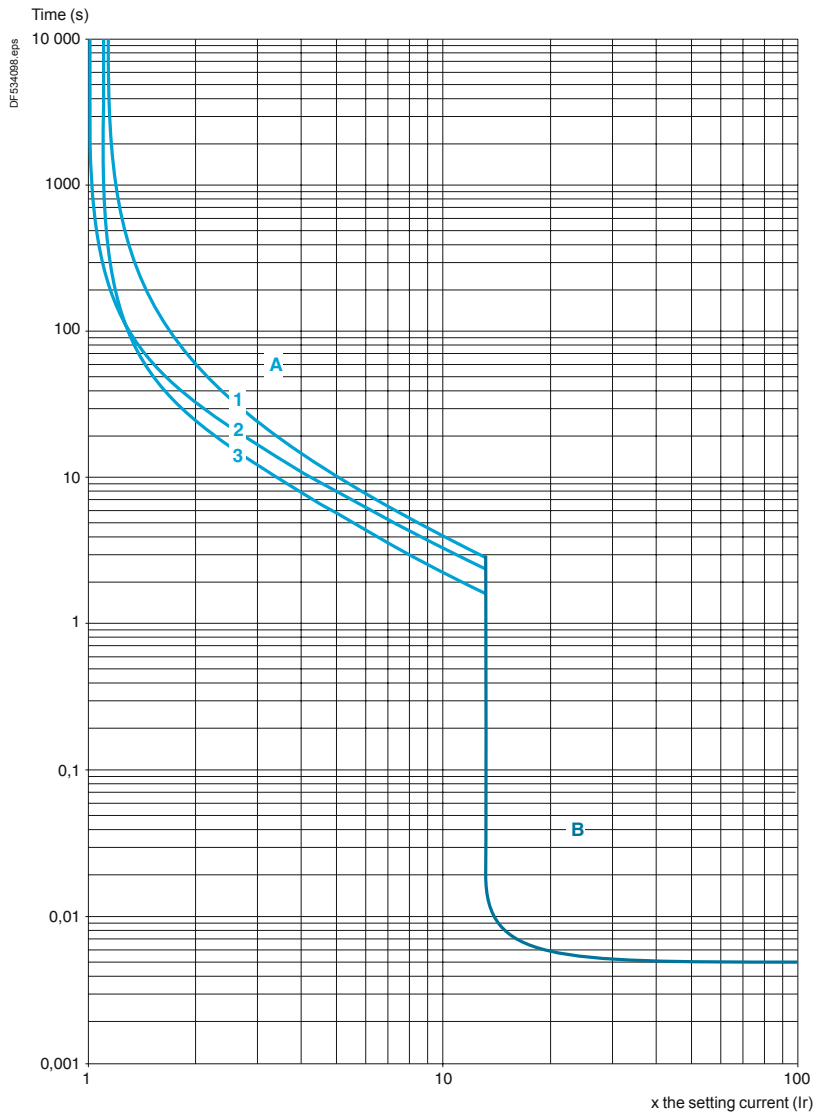

- 1 3 poles from cold state
- 2 2 poles from cold state
- 3 3 poles from hot state

- A Thermal overload relay protection zone
- B GV3 L protection zone



**Current limitation on short-circuit for GV3 L (3-phase 400/415 V)**

**Dynamic stress**

$I_{peak} = f(\text{prospective } I_{sc}) \text{ at } 1.05 U_e = 435 \text{ V}$

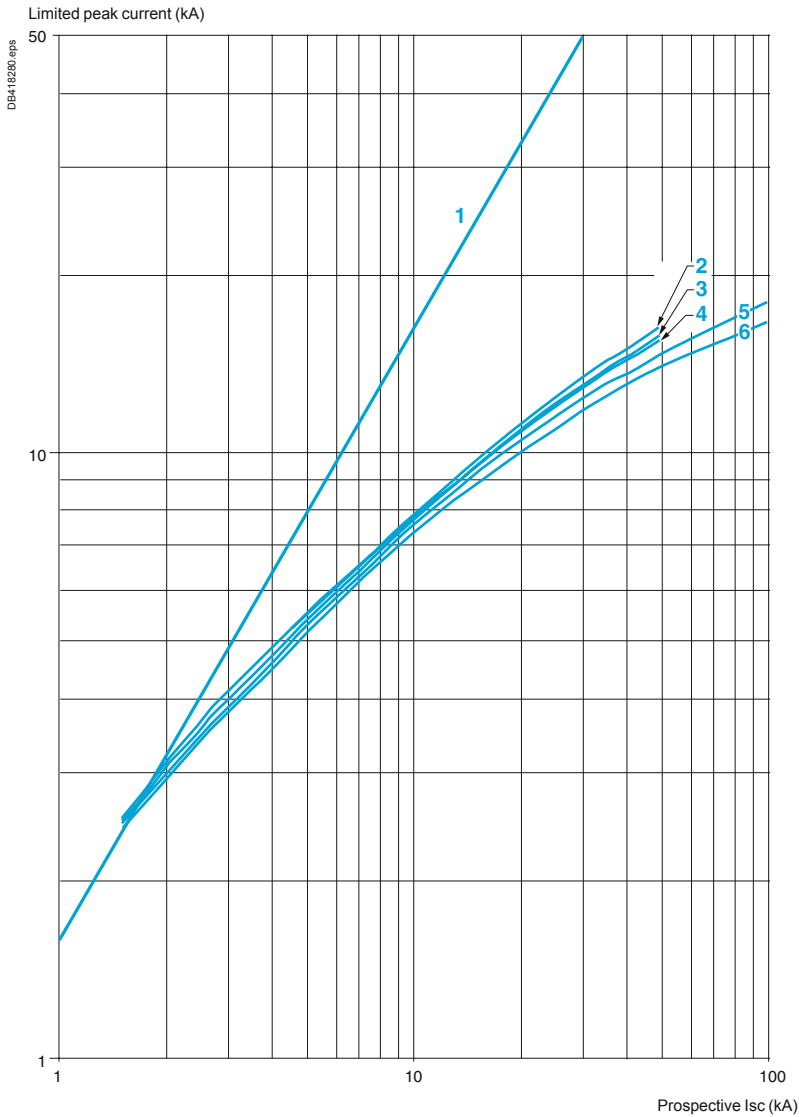

- 1 Maximum peak current
- 2 GV3 L65
- 3 GV3 L50
- 4 GV3 L40
- 5 GV3 L32
- 6 GV3 L25

## Thermal limit on short-circuit for GV3 L

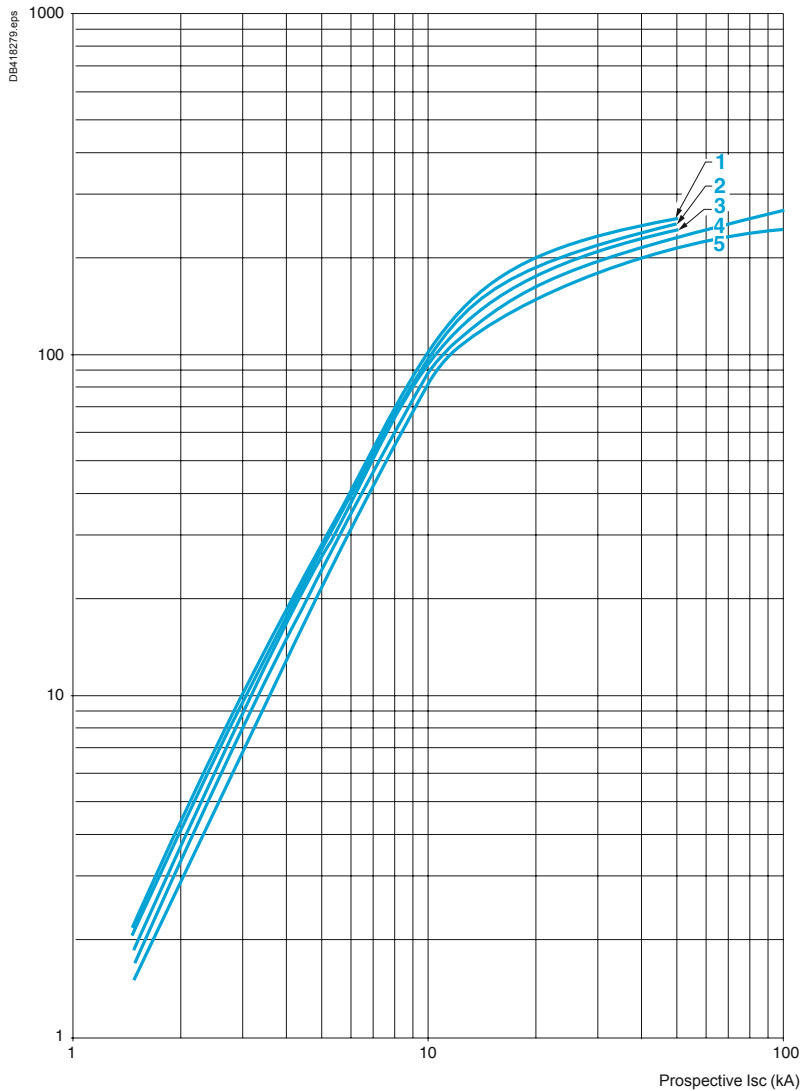
Thermal limit in A<sup>2</sup>sSum of I<sup>2</sup>dt = f (prospective I<sub>sc</sub>) at 1.05 U<sub>e</sub> = 435 VSum of I<sup>2</sup>dt (A<sup>2</sup>s)

- 1 GV3 L65
- 2 GV3 L50
- 3 GV3 L40
- 4 GV3 L32
- 5 GV3 L25

# TeSys protection components

## Magnetic motor circuit breakers

### GV2 L and GV2 LE

#### TeSys GV

#### GV2 L

##### Dimensions

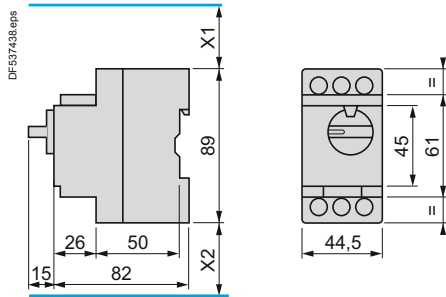

X1 Electrical clearance = 40 mm for  $U_e \leq 415$  V, or 80 mm for  $U_e = 440$  V, or 120 mm for  $U_e = 500$  and 690 V.  
X2 = 40 mm.

##### GV AD, AM, AN, AU, AS

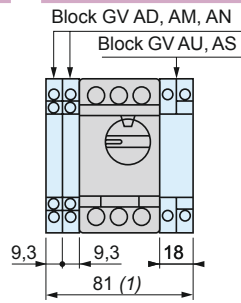

(1) Maximum.

##### GV2 AK00

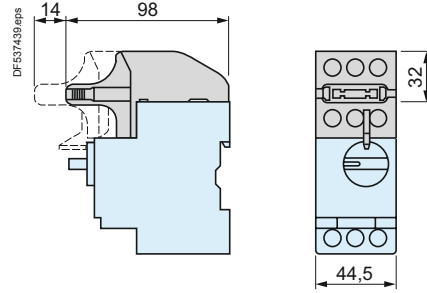

##### Mounting

On rail AM1 DE200,  
AM1 ED200 (35 x 15)

Panel mounted

On pre-slotted mounting  
plate AM1 PA

##### Adapter plate GK2 AF01

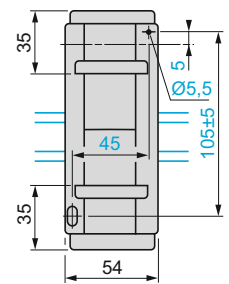
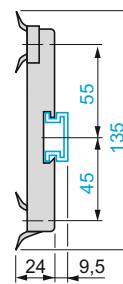
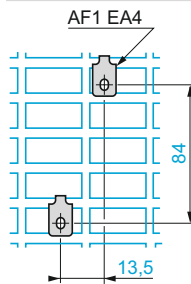
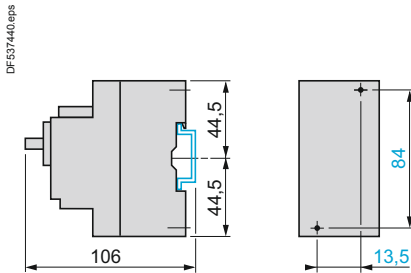

##### 7.5 mm height compensation plate GV1 F03



#### GV2 LE

##### Dimensions

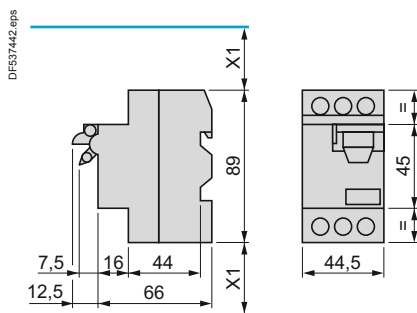

X1 Electrical clearance = 40 mm for  $U_e \leq 690$  V.

##### GV AD, AM, AN, AU, AS

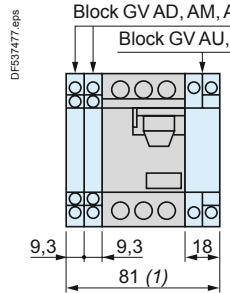

(1) Maximum.

##### GV AE

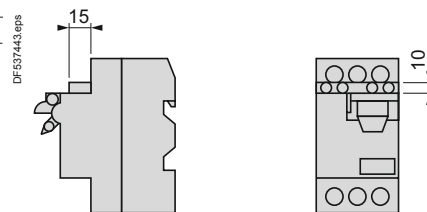

##### Mounting

On 35 mm rail

On panel with adapter plate GV2 AF02

On pre-slotted plate AM1 PA

On rails DZ5 MB201

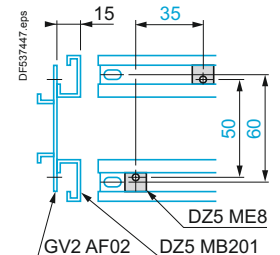
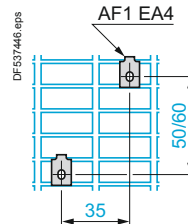
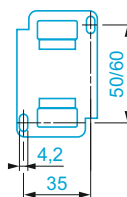
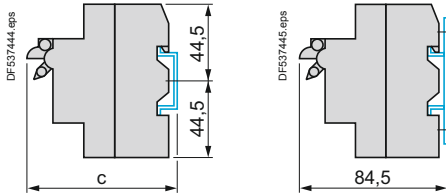

c = 80 on AM1 DP200  
(35 x 7.5) and 88 on  
AM1 DE200, ED200 (35 x 15)

#### TeSys GV

#### Mounting

##### Mounting of external operator GV2 APN01, GV2 APN02 or GV2 APN04 for motor circuit breakers GV2 L

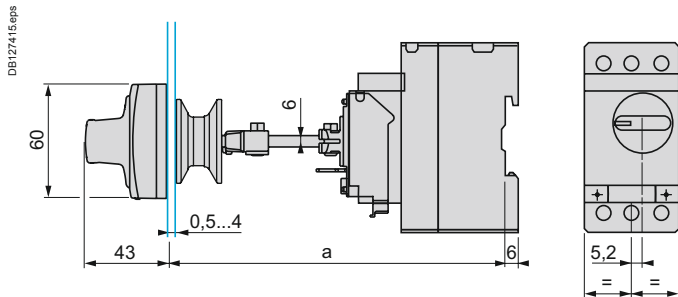

##### Door cut-out

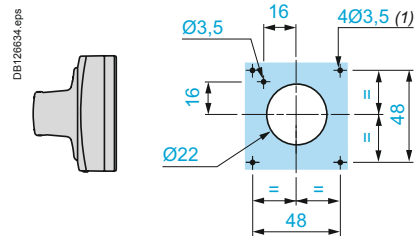

(1) For IP65 only.

##### Mounting of external operator GV2 APH02 for motor circuit breakers GV2 L

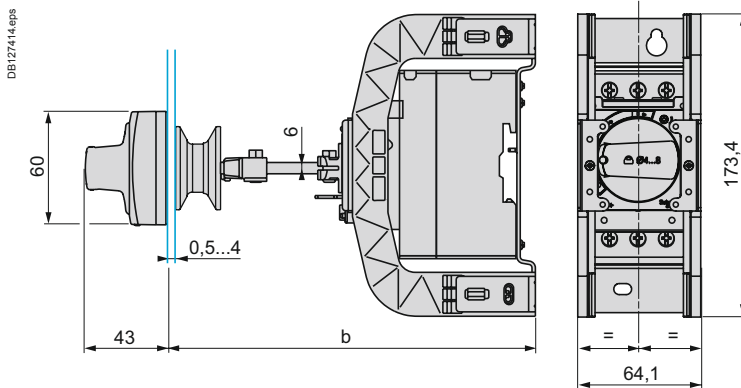

##### Door cut-out

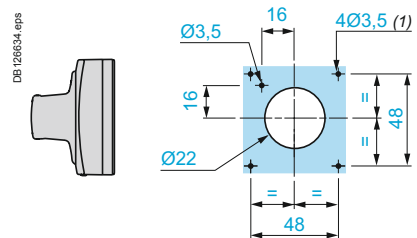

(1) For IP65 only.

	a		b	
	Mini	Maxi	Mini	Maxi
GV2 APN●●	140	250		
GV2 APN●● + GV APH02			151	250
GV2 APN●● + GV APK11	250	434	-	-
GV2 APN●● + GV APH02 + GV APK11	-	-	250	445

##### Mounting of external operator GV2 AP03 for GV2 LE

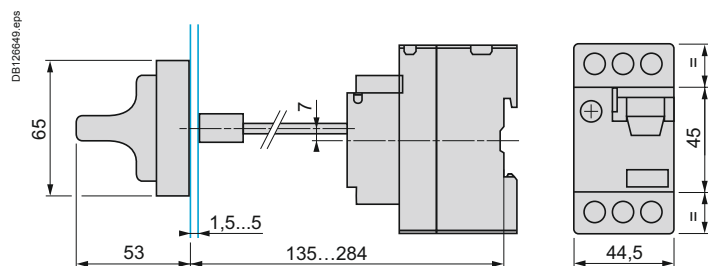

##### Door cut-out

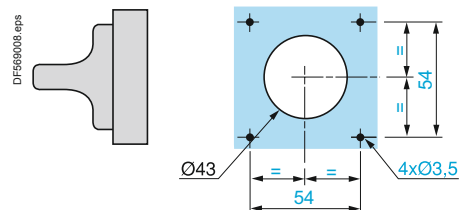

#### TeSys GV

#### GV2 L and GV2 LE

Sets of busbars GV2 G445, GV2 G454, GV2 G472, with terminal block GV2 G05

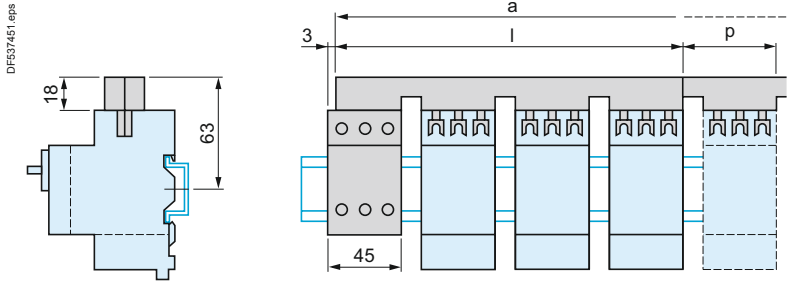

	l	p
GV2 G445 (4 x 45 mm)	179	45
GV2 G454 (4 x 54 mm)	206	54
GV2 G472 (4 x 72 mm)	260	72

Number of tap-offs	a			
	5	6	7	8
GV2 G445	224	269	314	359
GV2 G454	260	314	368	422
GV2 G472	332	404	476	548

#### Sets of busbars for GV2 L and GV2 LE

Sets of busbars GV2 G●●● with term. block GV1 G09

Sets of busbars GV2 G245, GV2 G254, GV2 GR272

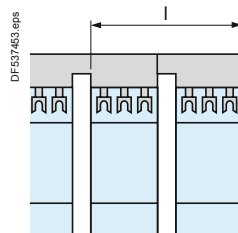
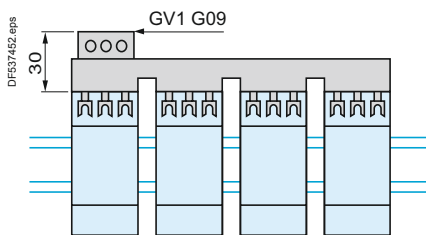

	l
GV2 G245 (2 x 45 mm)	89
GV2 G254 (2 x 54 mm)	98
GV2 G272 (2 x 72 mm)	116

#### Set of busbars GV2 G554

#### Sets of busbars GV2 G345 and GV2 G354

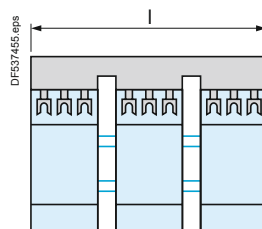
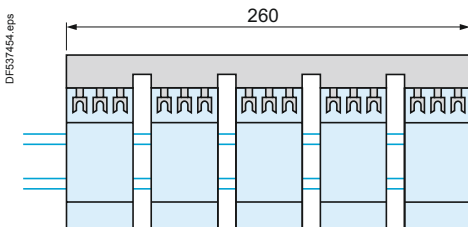

	l
GV2 G345 (3 x 45 mm)	134
GV2 G354 (3 x 54 mm)	152

## TeSys GV

### GV3 L

#### Dimensions

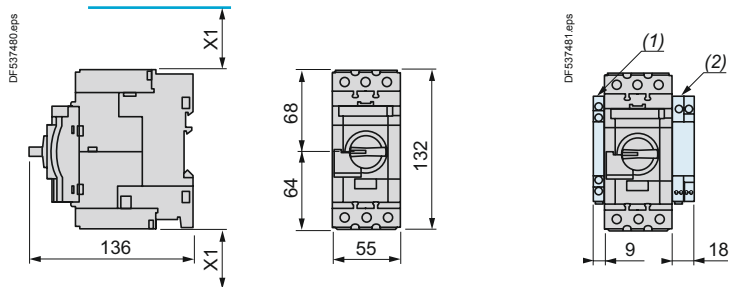

X1 = Electrical clearance (ISC max)  
40 mm for  $U_e \leq 500$  V, 50 mm for  $U_e \leq 690$  V

(1) Blocks GV AN●●, GV AD●● and GV AM11.  
(2) Blocks GV3 AU●● and GV3 AS●●.

**Note:** Leave a space of 9 mm between 2 circuit breakers: either an empty space or side-mounting add-on contact blocks.  
Side by side mounting is possible up to 40 °C.

#### Mounting

##### Mounting with Tesys contactor LC1 D40A...D65A and relay LR3 D313...365

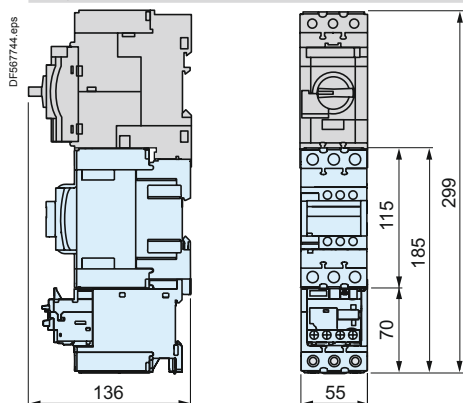

##### Side by side mounting with Tesys contactor LC1 D40A...D65A (S-shape busbar system GV3 S)

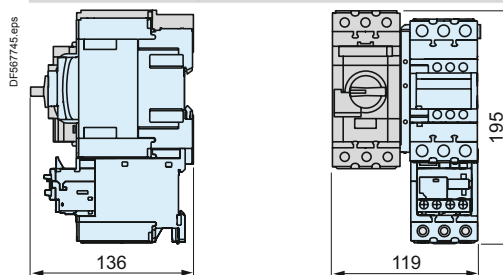

##### Mounting on rail AM1 DE200 or AM1 ED201

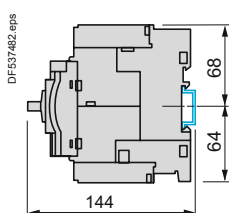

##### Panel mounting, using M4 screws

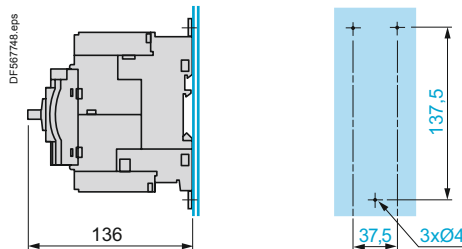

##### Mounting on pre-slotted plate AM1 PA

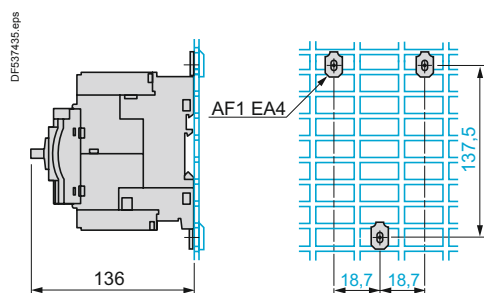

##### Set of busbars GV3 G264

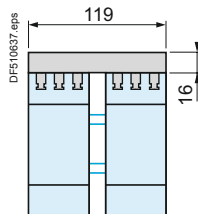

##### Set of busbars GV3 G364

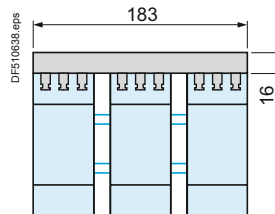

#### TeSys GV

#### Mounting

##### Mounting of external operator GV3 APN01, GV3 APN02 or GV3 APN04 for motor circuit breakers GV3 L

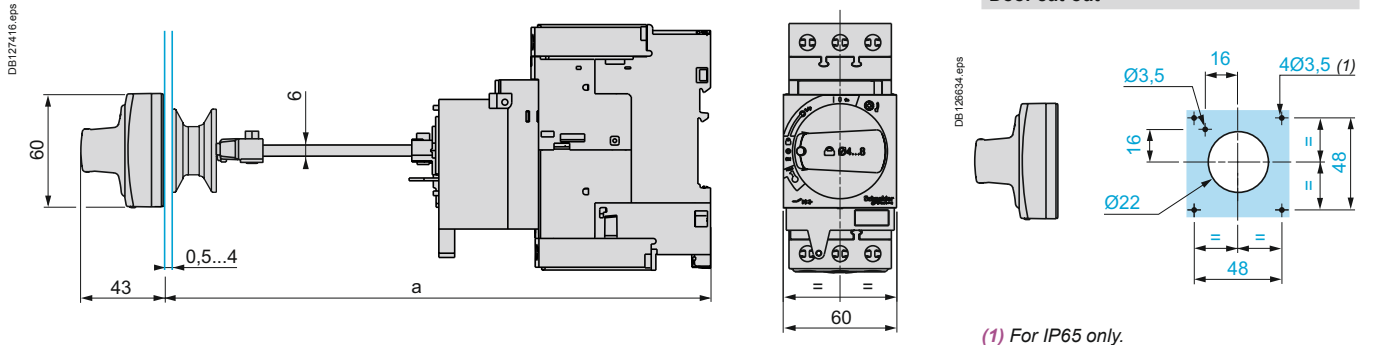

##### Mounting of external operator GV APH03 for motor circuit breakers GV3 L

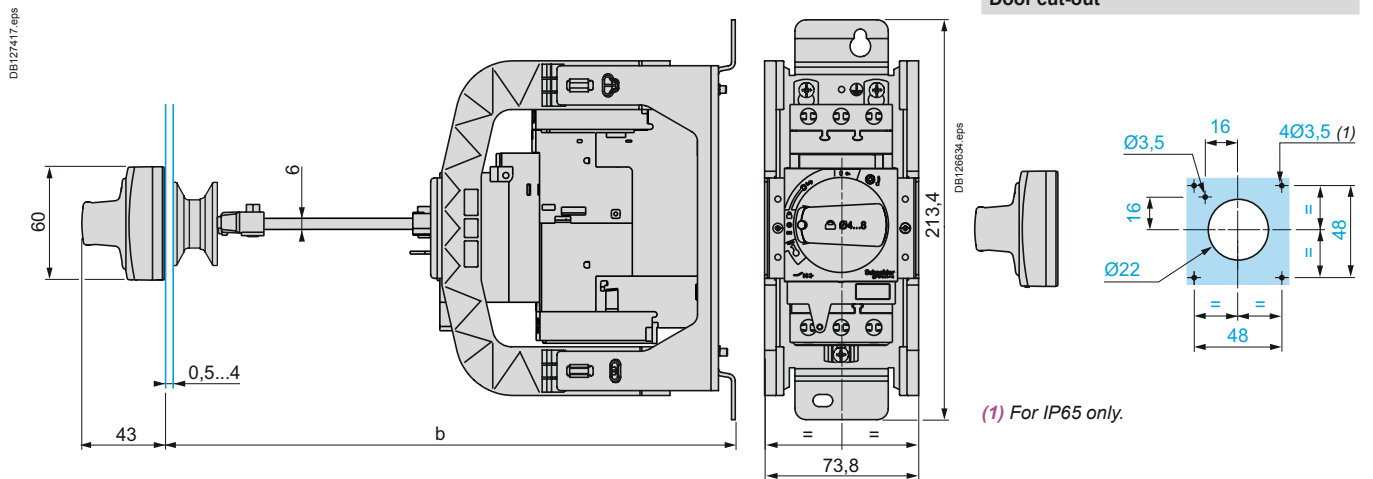

	a		b	
	Mini	Maxi	Mini	Maxi
GV3 APN●●	189	300	-	-
GV3 APN●● + GV APK12	300	481	-	-
GV3 APN●● + GV APH03	-	-	200	300
GV3 APN●● + GV APH03 + GV APK12	-	-	300	492

#### TeSys GV

#### Magnetic motor circuit breakers

##### GV2 L●●

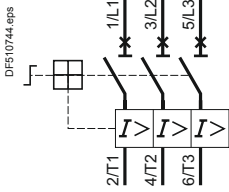

##### GV2 LE●●

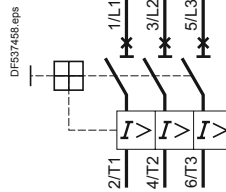

##### GV3 L●●

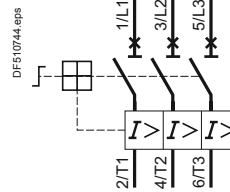

#### Accessories

##### Front mounting add-on contact blocks

##### Instantaneous auxiliary contacts

##### GV AE1

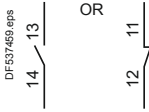

##### GV AE11

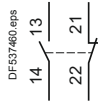

##### GV AE20

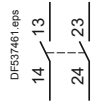

##### GV AED101 and GV AED011

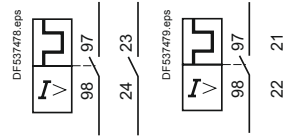

##### Side mounting add-on contact blocks

##### Instantaneous auxiliary contacts and fault signalling contacts

##### GV AD0110

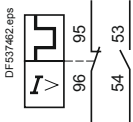

##### GV AD0101

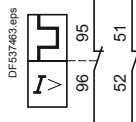

##### GV AD1010

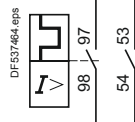

##### GV AD1001

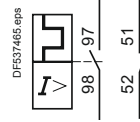

##### Instantaneous auxiliary contacts

##### GV AN11



##### GV AN20

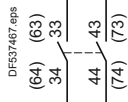

##### Short-circuit signalling contacts

##### GV AM11

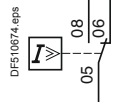

#### Voltage trips

##### GV AU●●●

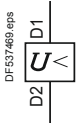

##### GV AS●●●

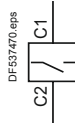

#### Start-Stop signalling contact blocks

##### GK2 AX10

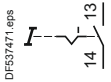

##### GK2 AX20

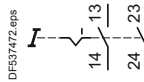

##### GK2 AX50

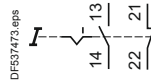

#### Fault signalling contact blocks

##### GK2 AX12

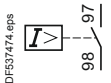

##### GK2 AX22

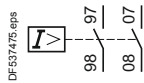

##### GK2 AX52

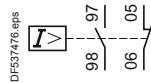



# TeSys protection components

## Thermal-magnetic motor circuit breakers GV2, GV3 and GV7

### TeSys GV

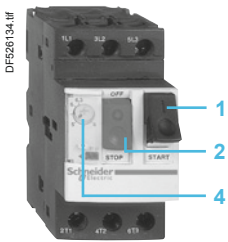

GV2 ME  
with screw clamp  
terminals

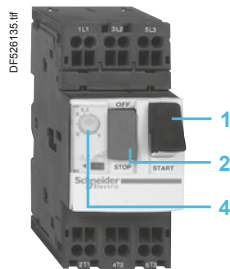

GV2 ME  
with spring terminals  
connections

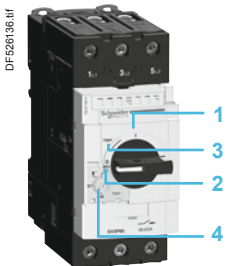

GV3 P

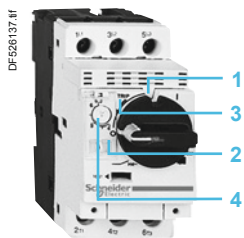

GV2 P

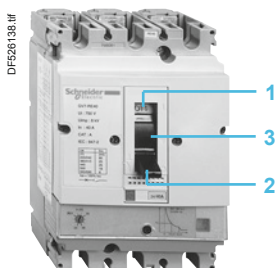

GV7 R

### Presentation

GV2 ME, GV2 P, GV3 ME, GV3 P and GV7 R motor circuit breakers are 3-pole thermal-magnetic circuit breakers **specifically designed for the control and protection of motors**, conforming to standards IEC 60947-2 and IEC 60947-4-1.

### Connection

#### GV2

GV2 ME and GV2 P circuit breakers are designed for connection by screw clamp terminals.

Circuit breaker GV2 ME can be supplied with lugs or spring terminal connections. Spring terminal connections ensure secure, permanent and durable clamping that is resistant to harsh environments, vibration and impact and are even more effective when conductors without cable ends are used. Each connection can take two independent conductors.

#### GV3

GV3 circuit breakers feature connection by BTR screws (hexagon socket head), tightened using a n° 4 Allen key.

This type of connection uses the **EverLink®** system with creep compensation <sup>(1)</sup> (Schneider Electric patent).

This technique makes it possible to achieve accurate and durable tightening torque, in order to avoid cable creep.

GV3 circuit breakers are also available with connection by lugs. This type of connection meets the requirements of certain Asian markets and is suitable for applications subject to strong vibration, such as railway transport.

#### GV7

GV7 circuit breakers: with connection by screw clamp terminals (for bars and lugs) and by clip-on connectors.

### Operation

Control is manual and local when the motor circuit breaker is used on its own. Control is automatic and remote when it is associated with a contactor.

#### GV2 ME and GV3 ME80

Pushbutton control.

Energisation is controlled manually by operating the Start button "I" **1**. De-energisation is controlled manually by operating the Stop button "O" **2**, or automatically by the thermal-magnetic protection elements or by a voltage trip attachment.

#### GV2 P, GV3 P and GV7 R

- Control by rotary knob: for GV2 P and GV3 P
- Control by rocker lever: for GV7 R.

Energisation is controlled manually by moving the knob or rocker lever to position "I" **1**. De-energisation is controlled manually by moving the knob or rocker lever to position "O" **2**. De-energisation due to a fault automatically places the knob or rocker lever in the "Trip" position **3**.

Re-energisation is possible only after having returned the knob or rocker lever to position "O".

<sup>(1)</sup> Creep: normal crushing phenomenon of copper conductors, that is accentuated over time.

# TeSys protection components

## Thermal-magnetic motor circuit breakers GV2, GV3 and GV7

### Presentation

#### Protection of motors and personnel

Motor protection is provided by the thermal-magnetic protection elements incorporated in the motor circuit breaker.

The **magnetic** elements (short-circuit protection) have a non-adjustable tripping threshold, which is equal to 13 times the maximum setting current of the thermal trips.

The **thermal** elements (overload protection) include automatic compensation for ambient temperature variations.

The rated operational current of the motor is displayed by means of a graduated knob 4. Personnel protection is also provided. All live parts are protected against direct finger contact from the front panel.

The addition of an undervoltage trip allows the circuit breaker to be de-energised in the event of an undervoltage condition. The user is therefore protected against sudden starting of the machine when normal voltage is restored, since the Start button "I" has to be pressed to restart the motor.

With the addition of a shunt trip, de-energisation of the unit can be remotely controlled.

The operators on both open-mounted and enclosed motor circuit breakers can be locked in the Stop position "O" by up to 4 padlocks.

Because they are suitable for isolation, these circuit breakers, in the open position, provide an adequate isolation distance and indicate the actual position of the moving contacts by the position of the operators.

#### Special features

These motor circuit breakers are easily installed in any configuration thanks to their universal fixing arrangement: screw fixing or clip-on mounting on symmetrical, asymmetrical or combination rails.

# TeSys protection components

## Thermal-magnetic motor circuit breakers

### TeSys GV

Environment			GV2 ME	GV2 P	GV3 P	GV3 ME80	GV7 R
Circuit breaker type			GV2 ME	GV2 P	GV3 P	GV3 ME80	GV7 R
Conforming to standards			IEC 60947-1, 60947-2, 60947-4-1, EN 60204, UL 508, CSA C 22.2 n° 14-05, NF C 63-650, 63-120, 79-130, VDE 0113, 0660		IEC/EN 60947-1, 60947-2, 60947-4-1, UL 508 type E, CSA C 22.2 n° 14-05 type E	IEC/EN, NF EN, BS EN, DINEN 60947-2, 60947-4-1	IEC 60947-1, 60947-2, 60947-4-1, EN 60947-1, 60947-2, EN 60947-4-1, NF C 63-650, 63-120, 79-130, VDE 0113, 0660
Product certifications			UL, CSA, CCC, CEBC, GOST, TSE, BV, GL, LROS, DNV, PTB, EZU, SETI, RINA, ATEX	UL <sup>(1)</sup> , CSA, PTB, EZU, GOST, TSE, DNV, LROS, GL, BV, RINA, CCC, ATEX	UL, CSA, CCC (pending), GOST, ATEX, GL, BV, LROS (DNV, RINA pending)	UL, CSA, LROS	UL, DNV, CCC
Protective treatment			"TH"		"TH"	"TC"	"TC"
Degree of protection (front face)	Conforming to IEC 60529	Open mounted	Against direct finger contact: IP20		Against direct finger contact: IP20	Against direct finger contact: IP20	IP405 with terminal shrouds
		In enclosure	<b>GV2 M●01:</b> IP41 <b>GV2 M●02:</b> IP55	–	<b>GV3 PC01</b> and <b>GV3 PC02:</b> IP55	<b>GV3 CE01:</b> IP55	–
Shock resistance	Conforming to IEC 60068-2-27	30 gn -11 ms			On: 15 gn -11 ms Off: 30 gn -11 ms	22 gn - 20 ms	15 gn -11 ms
Vibration resistance	Conforming to IEC 60068-2-6	5 gn (5...150 Hz)			4 gn (5...300 Hz)	2.5 gn (0...25 Hz)	2.5 gn (25 Hz)
Ambient air temperature	Storage	°C	-40...+80	-40...+80	-40...+80	-40...+80	-55...+95
	Operation	Open mounted	°C	-20...+60	-20...+60	-20...+60 <sup>(2)</sup>	-20...+60
Temperature compensation	Open mounted	°C	-20...+40	-20...+40	-20...+40	-20...+40	–
		In enclosure	°C	-20...+60	-20...+60	-20...+60	-20...+60
Flame resistance	Conforming to IEC 60695-2-1	°C	960		960	960	960
		m	2000		3000	3000	2000
Maximum operating altitude	Conforming to IEC 60947-1 § 7-1-6	Yes	Yes		Yes	–	Yes
Resistance to mechanical impact	Conforming to IEC 60947-1 § 7-1-6	J	0.5	0.5	10	0.5	0.5
			IK04		IK09 (in enclosure)	–	–
Sensitivity to phase failure			Yes, conforming to IEC 60947-4-1 § 7-2-1-5-2				

Technical characteristics			GV2 ME	GV2 P	GV2 RT	GV3 P	GV3 ME80	GV7 R●20... R●100	GV7 R●150	GV7 R●220
Circuit breaker type			GV2 ME	GV2 P	GV2 RT	GV3 P	GV3 ME80	GV7 R●20... R●100	GV7 R●150	GV7 R●220
Utilisation category	Conforming to IEC 60947-2		A			A	A	A		
	Conforming to IEC 60947-4-1		AC-3			AC-3	AC-3	AC-3		
Rated operational voltage (Ue)	Conforming to IEC 60947-2	V	690			690	690	690		
Rated insulation voltage (Ui)	Conforming to IEC 60947-2	V	690			690	690	750		
Rated voltage	Conforming to CSA C22-2 n° 14, UL 508	V	600			600	600 (B600)	600		
Rated operational frequency	Conforming to IEC 60947-4-1 UL, CSA	Hz	50/60			50/60	50/60	50/60		
Rated impulse withstand voltage (U imp)	Conforming to IEC 60947-2	kV	6			6	6	8		
Total power dissipated per pole		W	2.5			8	8	5	8.7	14.5
Mechanical durability (C.O.: Close, Open)		C.O.	100 000			50 000	30 000	50 000	40 000	20 000
Electrical durability for AC-3 duty	440 V In/2	C.O.	100 000			–	30 000	50 000	40 000	20 000
	440 V In	C.O.	–			50 000	–	30 000	20 000	10 000
Duty class (maximum operating rate)		C.O./h	25			25	25	25		
Maximum conventional rated thermal current (Ith)	Conforming to IEC 60947-4-1	A	0.16... 32	0.16... 32	0.40... 23	13... 65	80	12... 100	150	220
Rated duty	Conforming to IEC 60947-4-1		Continuous duty							

(1) UL 508 type E for GV2 P●H7.  
 (2) Leave a space of 9 mm between 2 circuit breakers: either an empty space, or side mounting add-on contact blocks. Side by side mounting is possible up to 40 °C.  
 (3) For operation up to 70 °C, please consult your Regional Sales Office.

Circuit breakers

### Mounting characteristics

Operating position  
Without derating, in relation to normal vertical mounting plane <sup>(1)</sup>

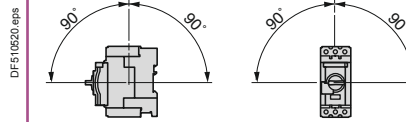

### Connection characteristics

#### Connection to screw clamp terminals or spring terminals

Bare cables

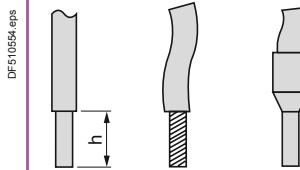

Circuit breaker type			GV2 ME		GV2 P		GV3 P		GV3 ME80	
Connection to screw clamp terminals <sup>(2)</sup> (Max. number of conductors x c.s.a.)		mm <sup>2</sup>	Min.	Max.	Min.	Max.	Min.	Max.	Min.	Max.
	Solid cable	mm <sup>2</sup>	2 x 1	2 x 6	2 x 1	2 x 6	2 x 1	1 x 25 and 1 x 35	1 x 2.5	1 x 35
	Flexible cable without cable end	mm <sup>2</sup>	2 x 1.5	2 x 6	2 x 1.5	2 x 6	2 x 1	1 x 25 and 1 x 35	1 x 2.5	2 x 16
	Flexible cable with cable end	mm <sup>2</sup>	2 x 1	2 x 4	2 x 1	2 x 4	2 x 1	1 x 25 and 1 x 35	1 x 2.5	2 x 16
Tightening torque		N.m	1.7	1.7	1.7	1.7	5	5: 25 mm <sup>2</sup> 8: 35 mm <sup>2</sup>	5	5
Connection to spring terminals Number of conductors x c.s.a.										
	Solid cable	mm <sup>2</sup>	2 x 1 <sup>(3)</sup>	2 x 6	-	-	-	-	-	-
	Flexible cable without cable end	mm <sup>2</sup>	2 x 1.5 <sup>(3)</sup>	2 x 4	-	-	-	-	-	-

#### Connection by bars or lugs

Bars or lugs

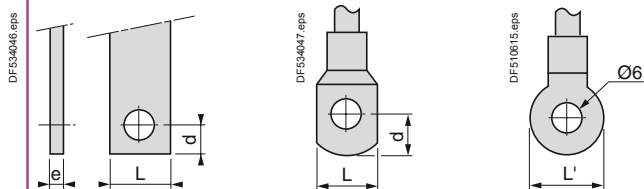

Circuit breaker type			GV2 ME●●6	GV3 P●●6	GV7 R●20...R●100	GV7 R●150	GV7 R●220
Pitch	Without spreaders	mm	13.5	17.5	35	35	35
	With spreaders	mm	-	-	45	45	45
Bars or cables with lugs	e	mm	≤ 6	≤ 6	≤ 6	≤ 6	≤ 6
	L	mm	≤ 9.5	≤ 13.5	≤ 25	≤ 25	≤ 25
	L'	mm	≤ 9.5	≤ 16.5	-	-	-
	d	mm	≤ 10	≤ 10	≤ 10	≤ 10	≤ 10
Screws			M4	M6	M6	M8	M8
	Tightening torque	N.m	1.7	6	10	15	15
Bare cables (copper or aluminium) with connectors	Height (h)	mm	-	-	20	20	20
	C.s.a.	mm <sup>2</sup>	-	-	1.5...95	1.5...95	1.5...185
	Tightening torque	N.m	-	-	15	15	15

(1) When mounting on a vertical rail, fit a stop to prevent any slippage.  
 (2) For motor circuit breakers **GV3 P**: BTR hexagon socket head screws, **EverLink**® system. Require use of an insulated Allen key, in compliance with local electrical wiring regulations.  
 (3) For cross-sections 1 to 1.5 mm<sup>2</sup>, the use of an **LA9 D99** cable end reducer is recommended.

# TeSys protection components

## Thermal-magnetic motor circuit breakers GV2 ME and GV2 P

### TeSys GV

Circuit breaker type		GV2 ME										GV2 P									
		01 to 06	07	08	10	14	16	20	21 & 22	23 & 25	32	01 to 06	07	08	10	14	16	20	21 & 22	32	
Rating	A	0.1 to 1.6	2.5	4	6.3	10	14	18	23 & 25	32	50	50	0.1 to 1.6	2.5	4	6.3	10	14	18	23 & 25	32
Breaking capacity conforming to IEC 60947-2	230/240 V	lcu	kA	*	*	*	*	*	*	*	50	50	*	*	*	*	*	*	*	*	*
		lcs % <sup>(1)</sup>		*	*	*	*	*	*	*	100	100	*	*	*	*	*	*	*	*	*
400/415 V	lcu	kA	*	*	*	*	*	15	15	15	10	*	*	*	*	*	*	*	50	50	50
	lcs % <sup>(1)</sup>		*	*	*	*	*	50	50	40	50	*	*	*	*	*	*	*	50	50	50
440 V	lcu	kA	*	*	*	50	15	8	8	6	6	*	*	*	*	*	*	50	20	20	20
	lcs % <sup>(1)</sup>		*	*	*	100	100	50	50	50	50	*	*	*	*	*	*	75	75	75	75
500 V	lcu	kA	*	*	*	50	10	6	6	4	4	*	*	*	*	*	50	42	10	10	10
	lcs % <sup>(1)</sup>		*	*	*	100	100	75	75	75	75	*	*	*	*	100	75	75	75	75	75
690 V	lcu	kA	*	3	3	3	3	3	3	3	3	*	8	8	6	6	6	4	4	4	4
	lcs % <sup>(1)</sup>		*	75	75	75	75	75	75	75	75	*	100	100	100	100	100	100	100	100	100
Associated fuses (if required) if lcs > breaking capacity lcu conforming to IEC 60947-2	230/240 V	aM	A	*	*	*	*	*	*	80	80	*	*	*	*	*	*	*	*	*	*
		gG	A	*	*	*	*	*	*	100	100	*	*	*	*	*	*	*	*	*	*
400/415 V	aM	A	*	*	*	*	*	63	63	80	80	*	*	*	*	*	*	*	100	100	100
	gG	A	*	*	*	*	*	80	80	100	100	*	*	*	*	*	*	*	125	125	125
440 V	aM	A	*	*	*	50	50	50	50	63	63	*	*	*	*	*	50	63	80	80	80
	gG	A	*	*	*	63	63	63	63	80	80	*	*	*	*	*	63	80	100	100	100
500 V	aM	A	*	*	*	50	50	50	50	50	50	*	*	*	*	*	50	50	50	50	50
	gG	A	*	*	*	63	63	63	63	63	63	*	*	*	*	63	63	63	63	63	63
690 V	aM	A	*	16	25	32	32	40	40	40	40	*	20	25	40	40	50	50	50	50	50
	gG	A	*	20	32	40	40	50	50	50	50	*	25	32	50	50	63	63	63	63	63

\* > 100 kA.  
 (1) As % of lcu.

**Breaking capacity of GV2 ME and GV2 P (used in association with current limiter GV1 L3)**

Circuit breaker type			GV2 ME										
Rating			A	01 to 06 0.1 to 1.6	07 2.5	08 4	10 6.3	14 10	16 14	20 18	21 23	22 25	32 32
Breaking capacity conforming to IEC 60947-2	230/240 V	Icu	kA	*	*	*	*	*	*	*	*	*	*
		Ics % <sup>(1)</sup>		*	*	*	*	*	*	*	*	*	*
	400/415 V	Icu	kA	*	*	*	*	*	100	100	100	100	100
		Ics % <sup>(1)</sup>		*	*	*	*	*	50	50	40	40	40
	440 V	Icu	kA	*	*	*	*	*	50	20	20	20	20
		Ics % <sup>(1)</sup>		*	*	*	*	*	75	75	75	75	75
	500 V	Icu	kA	*	*	*	*	50	42	10	10	10	10
		Ics % <sup>(1)</sup>		*	*	*	*	100	100	75	75	75	75

Circuit breaker type			GV2 P										
Rating			A	01 to 06 0.1 to 1.6	07 2.5	08 4	10 6.3	14 10	16 14	20 18	21 23	22 25	32 32
Breaking capacity conforming to IEC 60947-2	230/240 V	Icu	kA	*	*	*	*	*	*	*	*	*	*
		Ics % <sup>(1)</sup>		*	*	*	*	*	*	*	*	*	*
	400/415 V	Icu	kA	*	*	*	*	*	*	*	*	*	*
		Ics % <sup>(1)</sup>		*	*	*	*	*	*	*	*	*	*
	440 V	Icu	kA	*	*	*	*	*	100	100	100	100	100
		Ics % <sup>(1)</sup>		*	*	*	*	*	50	50	50	50	50
	500 V	Icu	kA	*	*	*	*	100	100	100	100	100	100
		Ics % <sup>(1)</sup>		*	*	*	*	50	50	50	50	50	50
	690 V <sup>(3)</sup>	Icu = Ics	kA	*	50	50	50	50	50	50	50	50	50

Circuit breaker type			GV2 ME										
Rating			A	01 to 06 0.1 to 1.6	07 2.5	08 4	10 6.3	14 10	16 14	20 18	21 23	22 25	32 32
Cable protection against thermal stress in the event of short-circuit (PVC insulated copper cables)	Minimum c.s.a. protected at 40 °C at Isc max.	1 mm <sup>2</sup>		●	●	●	≤ 10 kA	≤ 6 kA	<sup>(2)</sup>	<sup>(2)</sup>	<sup>(2)</sup>	<sup>(2)</sup>	<sup>(2)</sup>
		1.5 mm <sup>2</sup>		●	●	●	≤ 20 kA	≤ 10 kA	<sup>(2)</sup>	<sup>(2)</sup>	<sup>(2)</sup>	<sup>(2)</sup>	<sup>(2)</sup>
		2.5 mm <sup>2</sup>		●	●	●	●	●	●	●	●	●	<sup>(2)</sup>
		4...6 mm <sup>2</sup>		●	●	●	●	●	●	●	●	●	●

\* > 100 kA.  
 ● Cable c.s.a. protected.  
 (1) As % of Icu.  
 (2) Cable c.s.a. not protected.  
 (3) With limiter LA9 LB920.

Breaking capacity of GV3 P and GV3 ME80											
Motor circuit breaker type				GV3 P						GV3 ME80	
Rating			A	13	18	25	32	40	50	65	80
Breaking capacity conforming to IEC 60947-2	230/240 V	Icu	kA	100	100	100	100	100	100	100	100
		Ics % <sup>(1)</sup>		100	100	100	100	100	100	100	100
	400/415 V	Icu	kA	100	100	100	100	50	50	50	15
		Ics % <sup>(1)</sup>		100	100	100	100	100	100	100	50
	440 V	Icu	kA	50	50	50	50	50	50	50	10
		Ics % <sup>(1)</sup>		100	100	100	100	100	100	100	60
	500 V	Icu	kA	12	12	12	12	12	12	12	4
		Ics % <sup>(1)</sup>		50	50	50	50	50	50	50	100
	690 V	Icu	kA	6	6	6	6	6	6	6	2
		Ics % <sup>(1)</sup>		50	50	50	50	50	50	50	100
Associated fuses, if required if Isc > breaking capacity Icu	230/240 V	aM	A	*	*	*	*	*	*	*	*
		gG	A	*	*	*	*	*	*	*	*
	415 V	aM	A	*	*	*	*	125	125	125	315
		gG	A	*	*	*	*	160	160	160	400
	440 V	aM	A	63	80	125	125	125	125	125	315
		gG	A	80	100	160	160	160	160	160	400
	500 V	aM	A	63	63	63	63	80	80	80	200
		gG	A	80	80	80	80	100	100	100	250
	690 V	aM	A	50	50	50	50	63	63	63	200
		gG	A	63	63	63	63	80	80	80	250

\* Fuse not required: breaking capacity Icn > Isc.  
 (1) As % of Icu.

Breaking capacity of GV7 R										
Circuit breaker type			A	GV7						
				RE20...RE100	RS20...RS100	RE150	RS150	RE220	RS220	
Rating				12...20 to 60...100		90...150	90...150	132...220	132...220	
Breaking capacity conforming to IEC 60947-2	230/240 V	Icu	kA	85	100	85	100	85	100	
		Ics % <sup>(1)</sup>		100	100	100	100	100	100	
	400/415 V	Icu	kA	36	70	35	70	35	70	
		Ics % <sup>(1)</sup>		100	100	100	100	100	100	
	440 V	Icu	kA	36	65	35	65	35	65	
		Ics % <sup>(1)</sup>		100	100	100	100	100	100	
	500 V	Icu	kA	18	50	30	50	30	50	
		Ics % <sup>(1)</sup>		100	100	100	100	100	100	
	690 V	Icu	kA	8	10	8	10	8	10	
		Ics % <sup>(1)</sup>		100	100	100	100	100	100	
	Cable protection against thermal stress in the event of short-circuit (PVC insulated copper cables)	Minimum c.s.a. protected at 40 °C at Isc max.	4 mm <sup>2</sup>		≤ 6 kA	≤ 6 kA	<sup>(2)</sup>	<sup>(2)</sup>	<sup>(2)</sup>	<sup>(2)</sup>
			6 mm <sup>2</sup>		●	≤ 25 kA	<sup>(2)</sup>	<sup>(2)</sup>	<sup>(2)</sup>	<sup>(2)</sup>
10...50 mm <sup>2</sup>				●	●	●	●	●	●	

(1) As % of Icu.  
 ● Cable c.s.a. protected.  
 (2) Cable c.s.a. not protected.



**Thermal-magnetic tripping curves for GV2 ME and GV2 P**

Average operating times at 20 °C related to multiples of the setting current

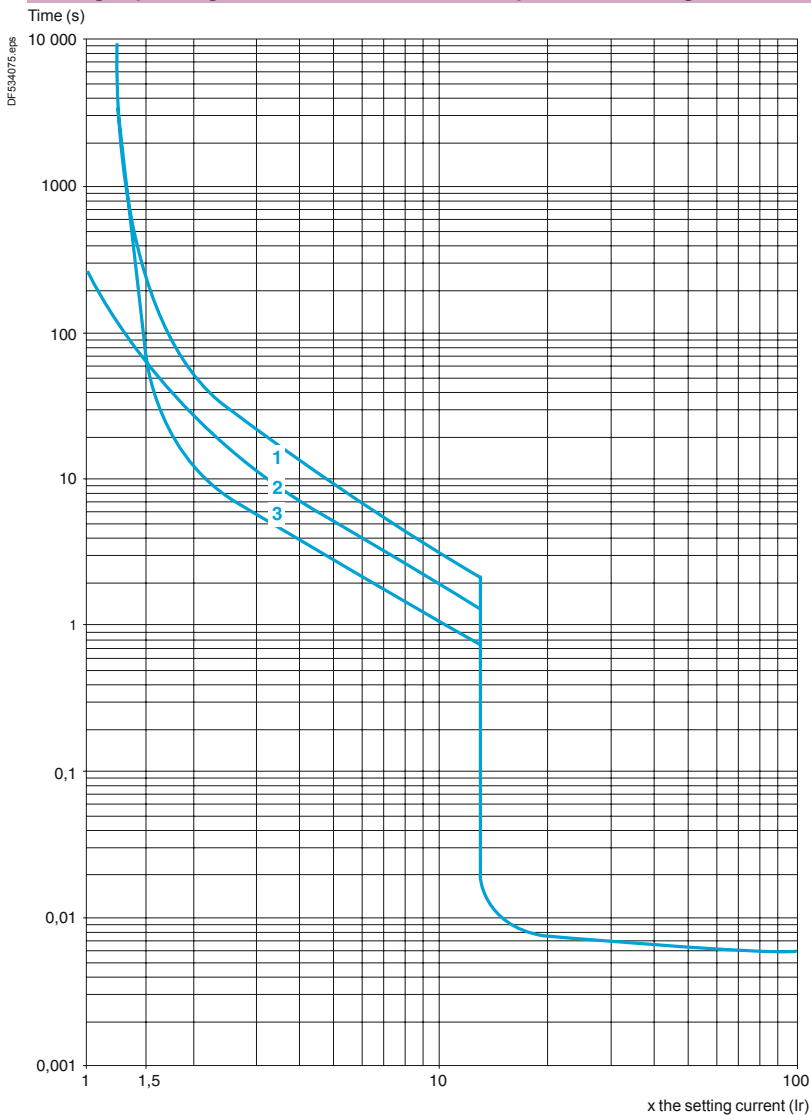

- 1 3 poles from cold state
- 2 2 poles from cold state
- 3 3 poles from hot state

## Current limitation on short-circuit for GV2 ME and GV2 P (3-phase 400/415 V)

## Dynamic stress

$I_{peak} = f(\text{prospective } I_{sc}) \text{ at } 1.05 U_e = 435 \text{ V}$

Limited peak current (kA)

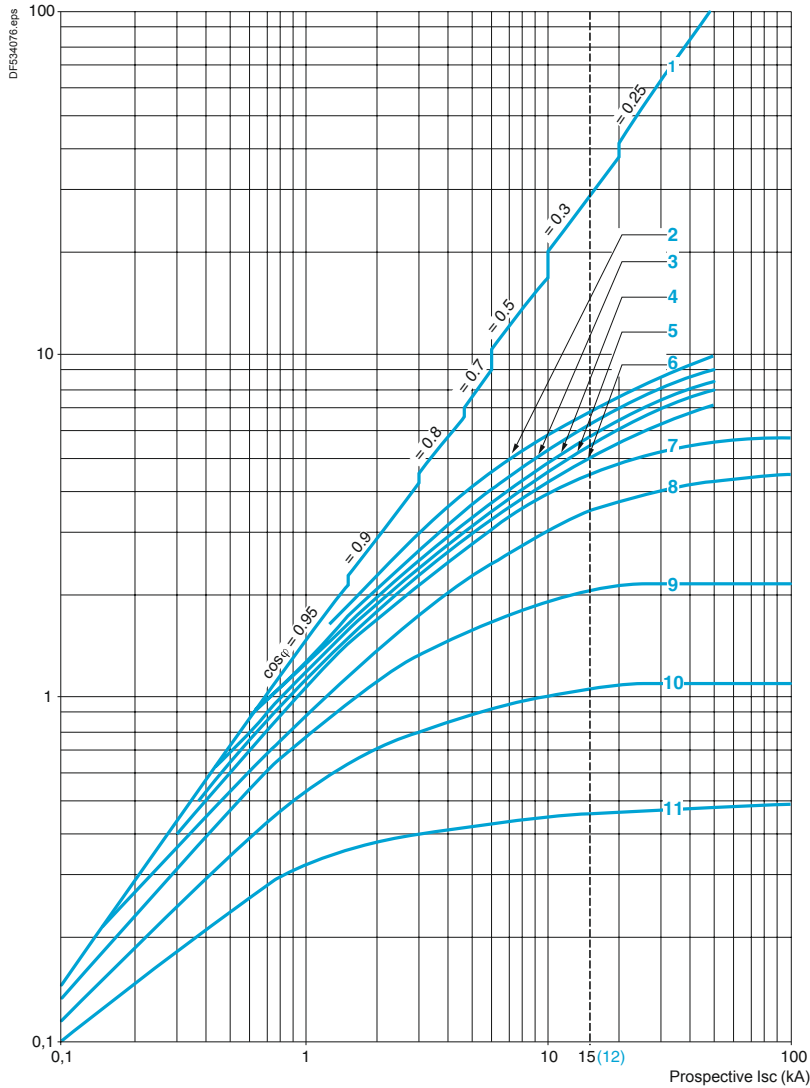

1 Maximum peak current

2 24 -32 A

3 20 -25 A

4 17 -23 A

5 13 -18 A

6 9 -14 A

7 6 -10 A

8 4 -6.3 A

9 2.5 -4 A

10 1.6 -2.5 A

11 1 -1.6 A

12 Limit of rated ultimate breaking capacity on short-circuit of GV2 ME (14, 18, 23 and 25 A ratings)

### Thermal limit on short-circuit for GV2 ME

#### Thermal limit in kA<sup>2</sup>s in the magnetic operating zone

Sum of I<sup>2</sup>dt = f (prospective I<sub>sc</sub>) at 1.05 U<sub>e</sub> = 435 V

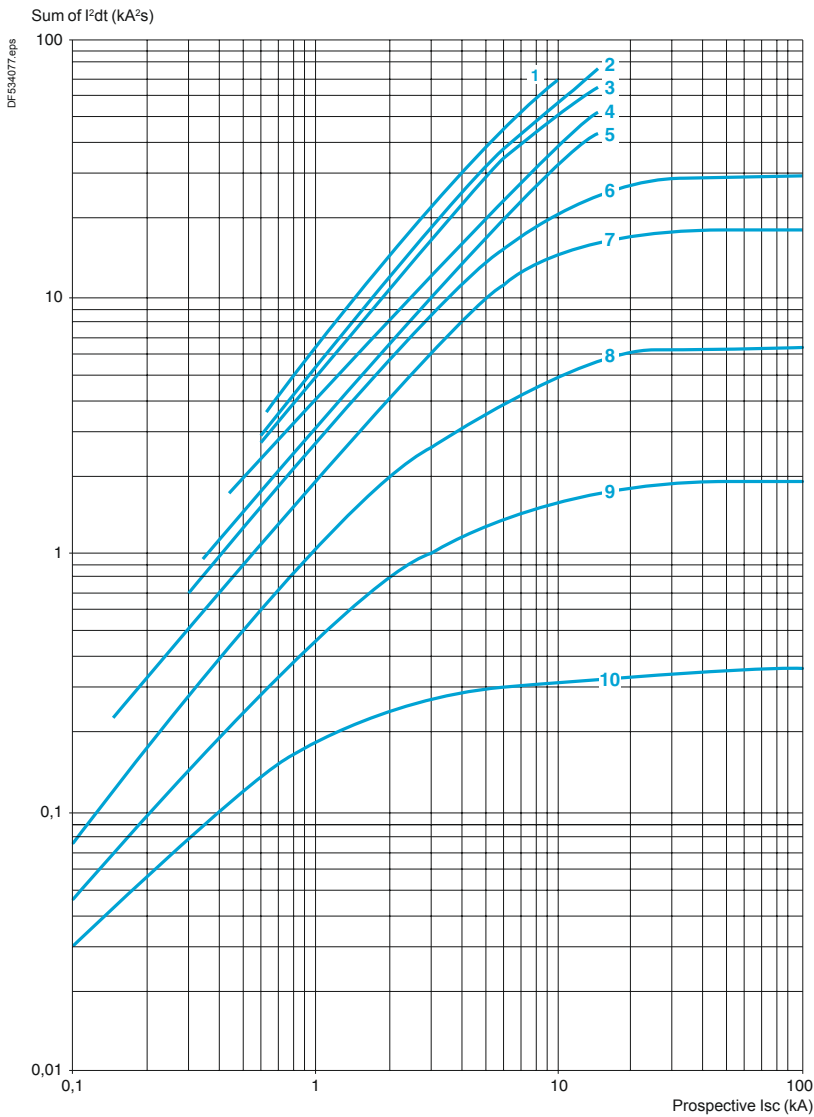

- 1 24-32 A
- 2 20-25 A
- 3 17-23 A
- 4 13-18 A
- 5 9-14 A
- 6 6-10 A
- 7 4-6.3 A
- 8 2.5-4 A
- 9 1.6-2.5 A
- 10 1-1.6 A

#### Thermal limit on short-circuit for GV2 P

Thermal limit in  $\text{kA}^2\text{s}$  in the magnetic operating zone

Sum of  $I^2dt = f$  (prospective  $I_{sc}$ ) at  $1.05 U_e = 435 \text{ V}$

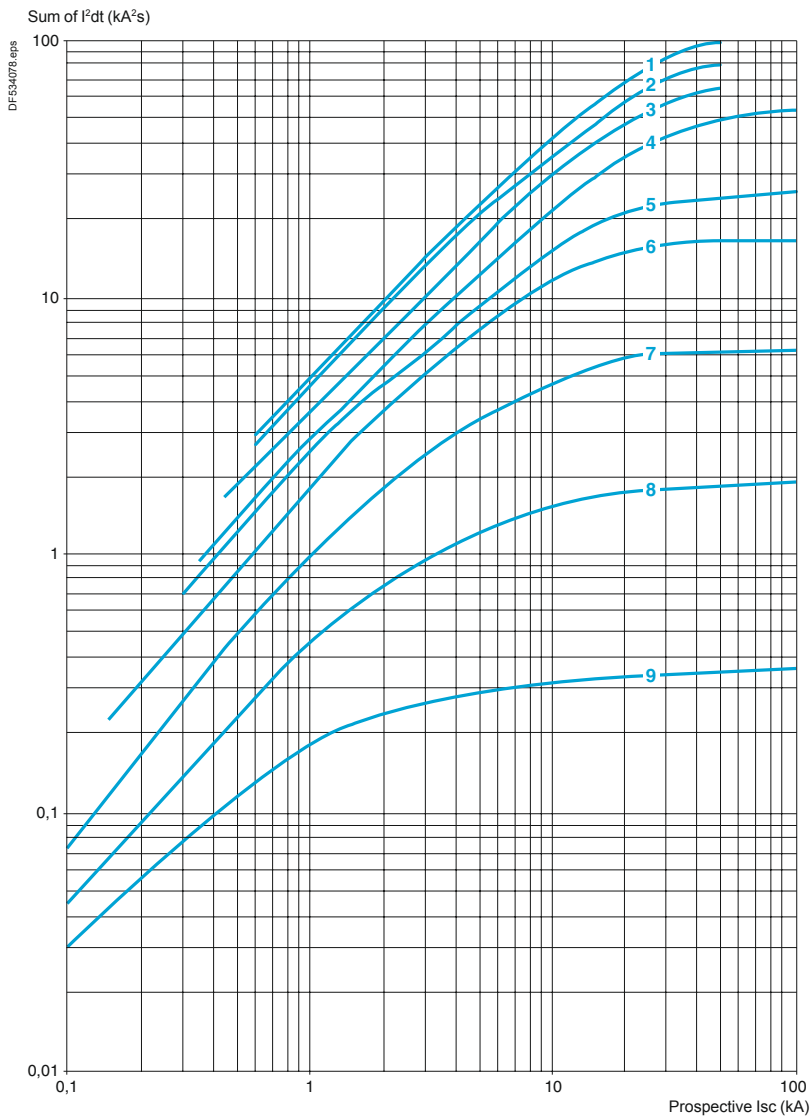

- 1 24 -32 A
- 1 20 -25 A
- 2 17 -23 A
- 3 13 -18 A
- 4 9 -14 A
- 5 6 -10 A
- 6 4 -6.3 A
- 7 2.5 -4 A
- 8 1.6 -2.5 A
- 9 1 -1.6 A

### Thermal-magnetic tripping curves

Average operating times at 20 °C related to multiples of the setting current

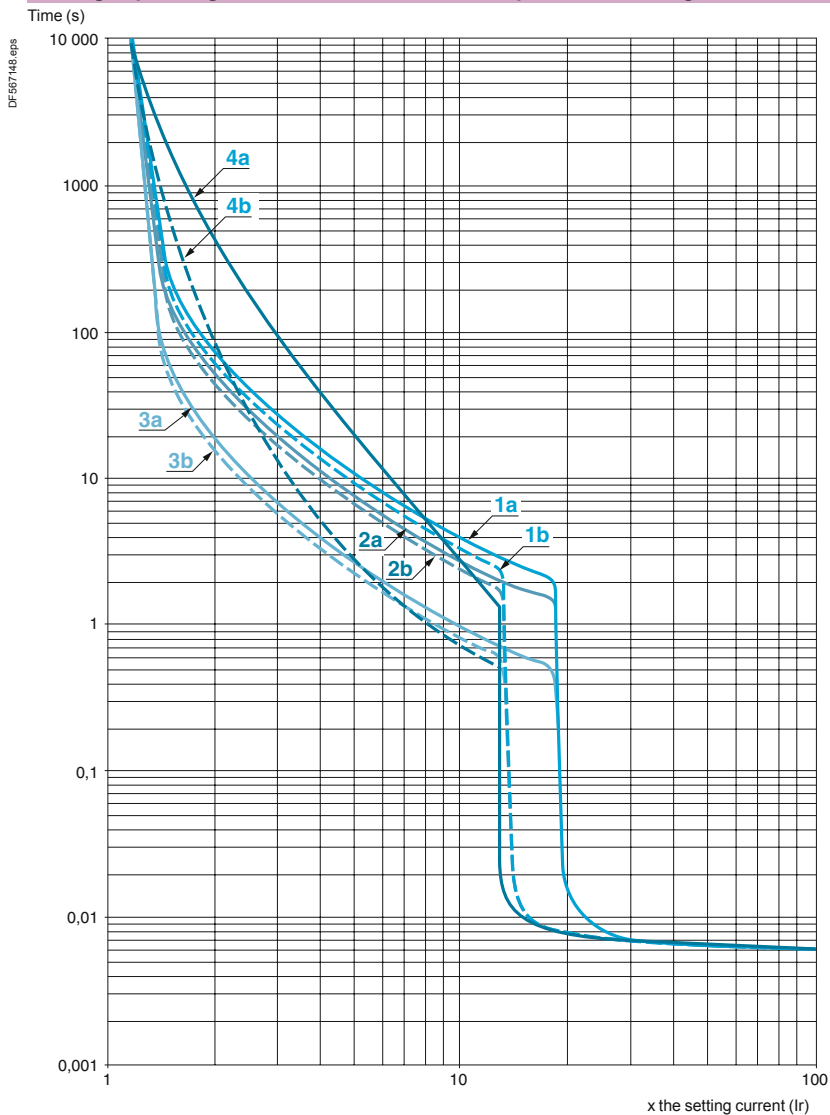

- 1a 3 poles from cold state ( $I_r$  mini.) : GV3 P
- 1b 3 poles from cold state ( $I_r$  maxi.) : GV3 P
- 2a 2 poles from cold state ( $I_r$  mini.) : GV3 ME80
- 2b 2 poles from cold state ( $I_r$  maxi.) : GV3 ME80
- 3a 3 poles from hot state ( $I_r$  mini.) : GV3 P
- 3b 3 poles from hot state ( $I_r$  maxi.) : GV3 P
- 4a 3 poles from hot state ( $I_r$  mini.) : GV3 ME80
- 4b 3 poles from hot state ( $I_r$  maxi.) : GV3 ME80

**Current limitation on short-circuit (3-phase 400/415 V)**

**Dynamic stress**

$I_{peak} = f(\text{prospective } I_{sc}) \text{ at } 1.05 U_e = 435 \text{ V}$

Limited peak current (kA)

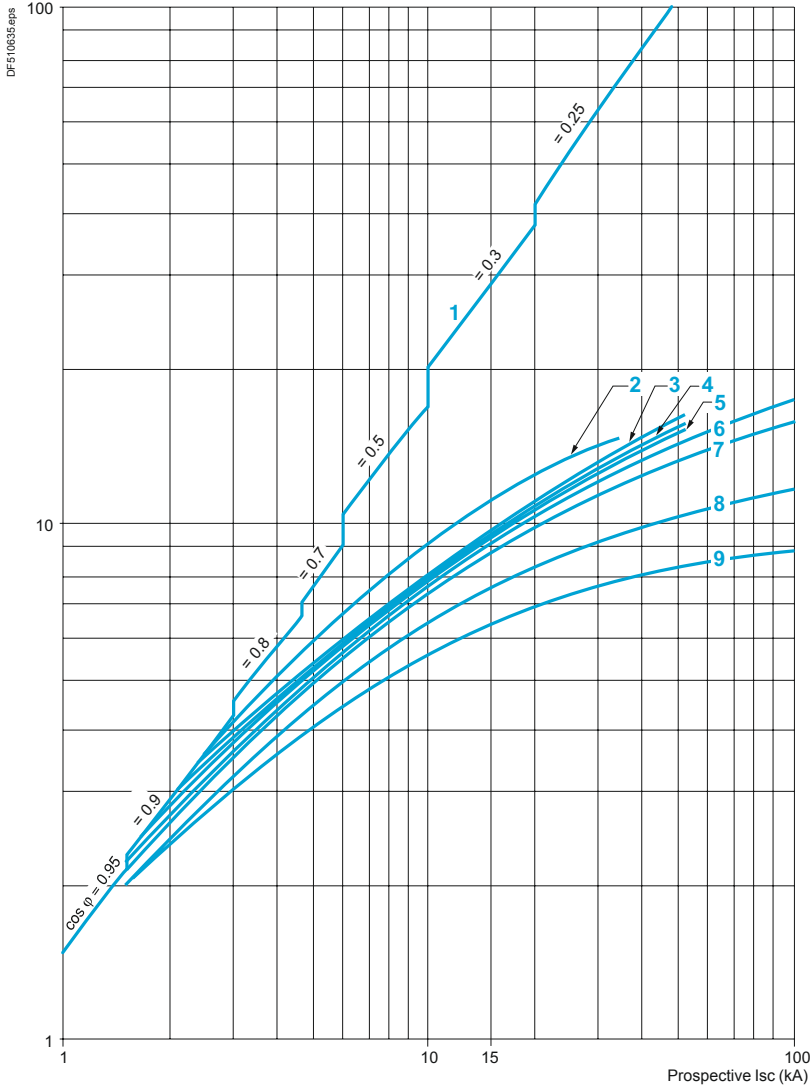

- 1 Maximum peak current
- 2 56 -80 A
- 3 48 -65 A
- 4 37 -50 A
- 5 30 -40 A
- 6 23 -32 A
- 7 17 -25 A
- 8 12 -18 A
- 9 9 -13 A

TeSys GV

**Maximum thermal limit on short-circuit**

**Thermal limit in kA<sup>2</sup>s in the magnetic operating zone**

Sum of I<sup>2</sup>dt = f (prospective I<sub>sc</sub>) at 1.05 U<sub>e</sub> = 435 V

Sum of I<sup>2</sup>dt (kA<sup>2</sup>s)

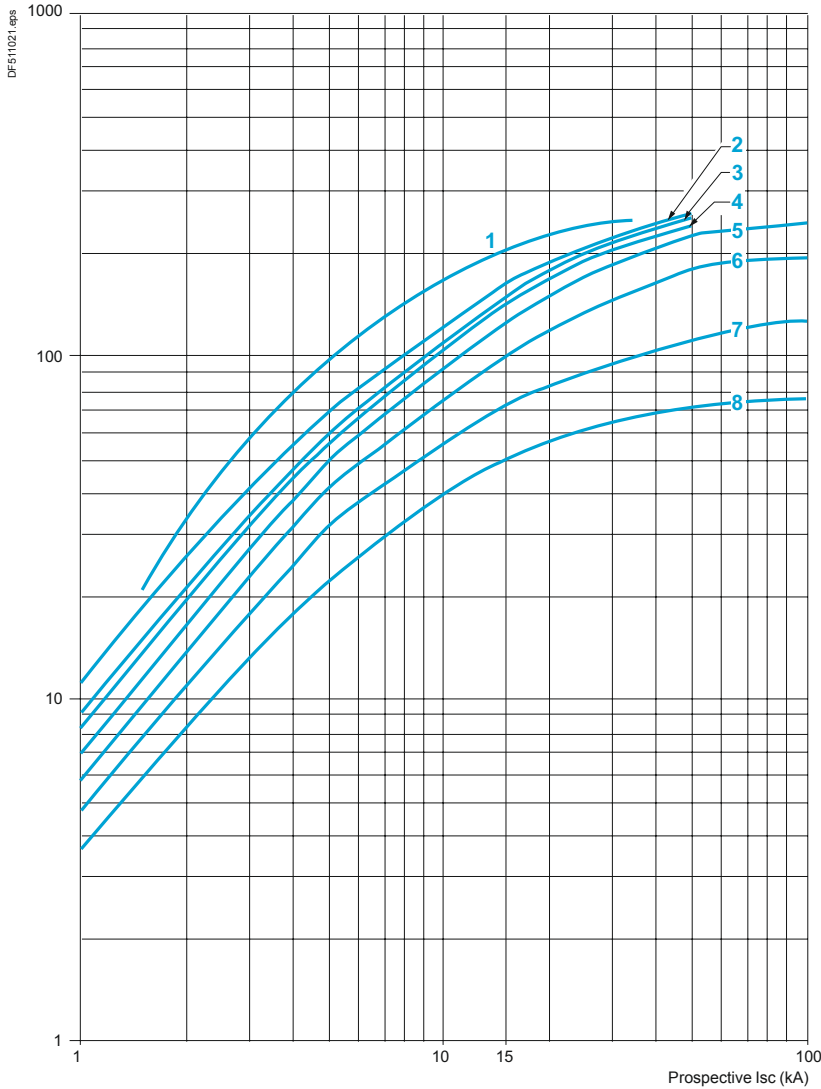

- 1 56-80 A (GV3 ME80)
- 2 48-65 A (GV3 P65)
- 3 37-50 A (GV3 P50)
- 4 30-40 A (GV3 P40)
- 5 23-32 A (GV3 P32)
- 6 17-25 A (GV3 P25)
- 7 12-18 A (GV3 P18)
- 8 9-13 A (GV3 P13)

#### Thermal-magnetic tripping curves for GV7 R

Average operating times at 20 °C related to multiples of the setting current

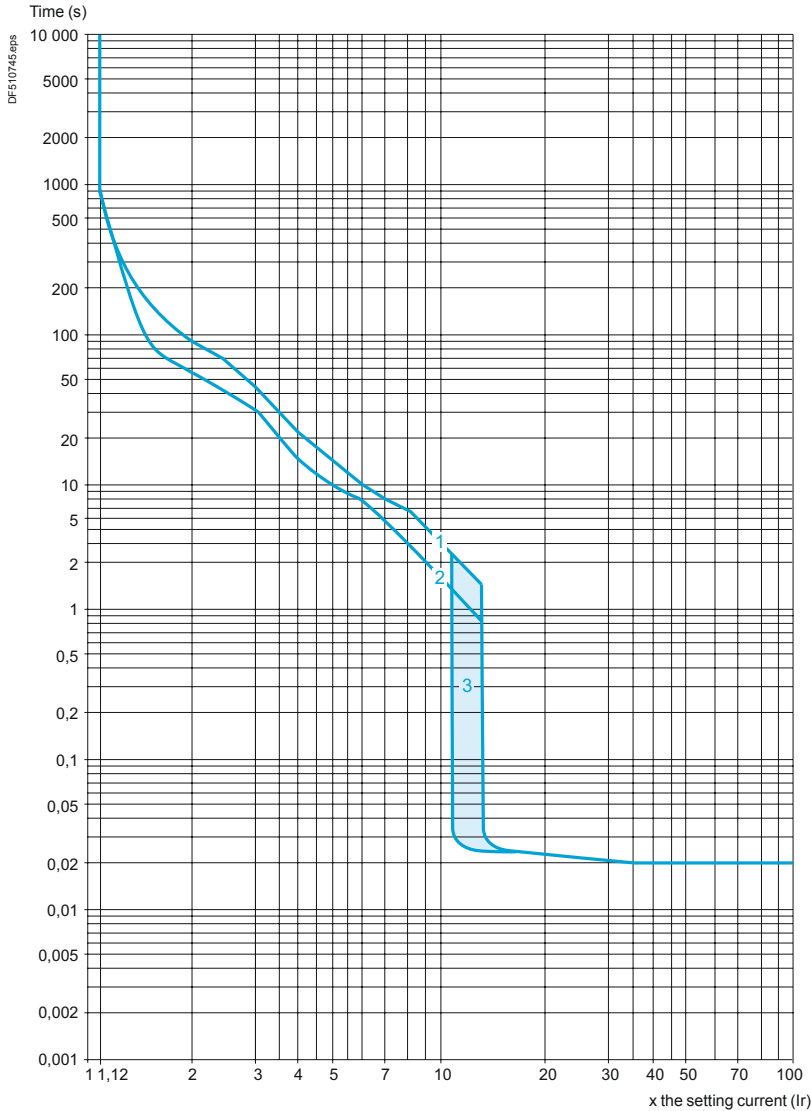

- 1 Cold state curve
- 2 Cold state curve
- 3 12...14 Ir

In the event of total phase failure, tripping occurs after 4 s ± 20 %



### TeSys GV

#### Current limitation on short-circuit (3-phase 400/415 V)

##### Dynamic stress

$$I_{peak} = f(\text{prospective } I_{sc})$$

##### For GV7 RE only

Limited peak current (kA)

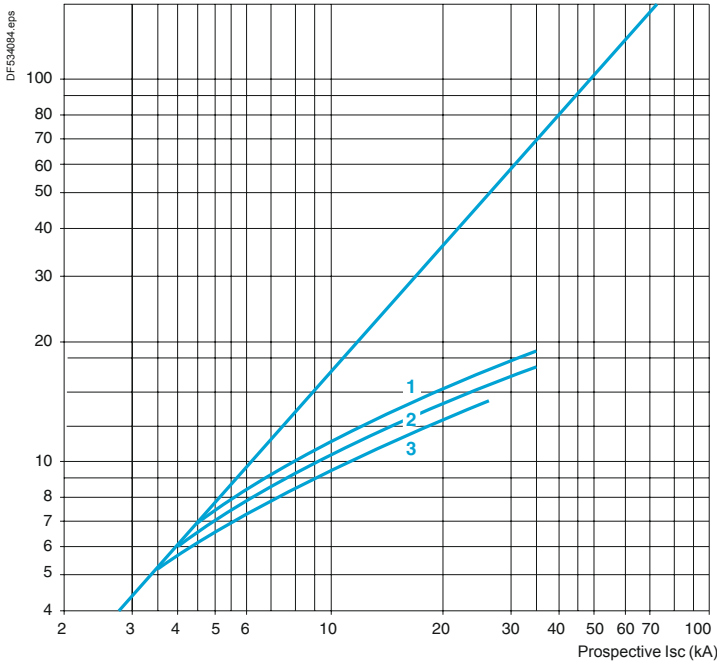

- 1 GV7 RE220
- 2 GV7 RE150
- 3 GV7 RE100

##### For GV7 RS only

Limited peak current (kA)

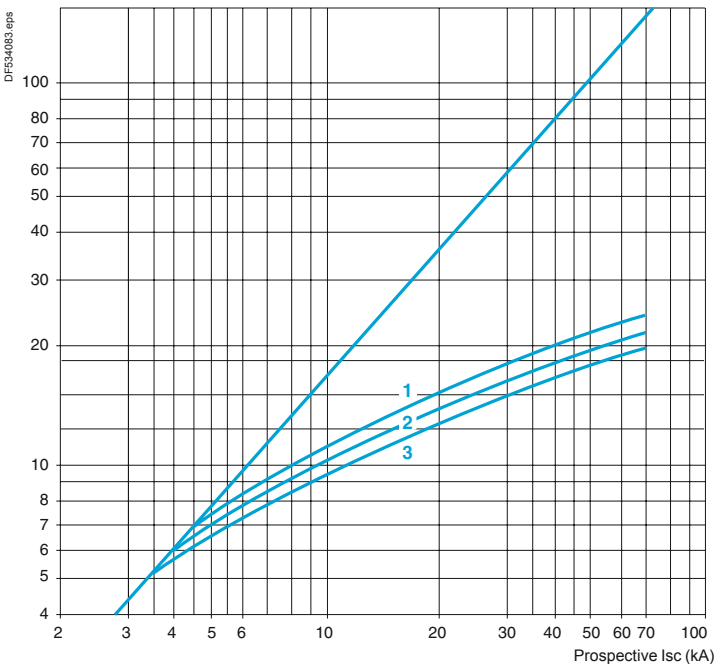

- 1 GV7 RS220
- 2 GV7 RS150
- 3 GV7 RS100

#### TeSys GV

#### Thermal limit (3-phase 400/415 V)

##### Thermal limit

Sum of  $I^2dt = f$  (prospective  $I_{sc}$ )

##### For GV7 RE only

Sum of  $I^2dt$  (A<sup>2</sup>s)

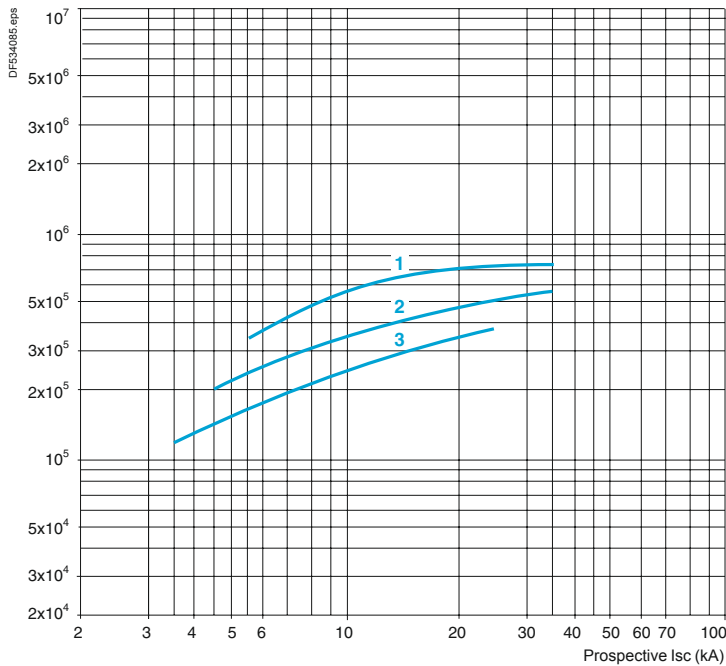

- 1 GV7 RE220
- 2 GV7 RE150
- 3 GV7 RE100

##### For GV7 RS only

Sum of  $I^2dt$  (A<sup>2</sup>s)

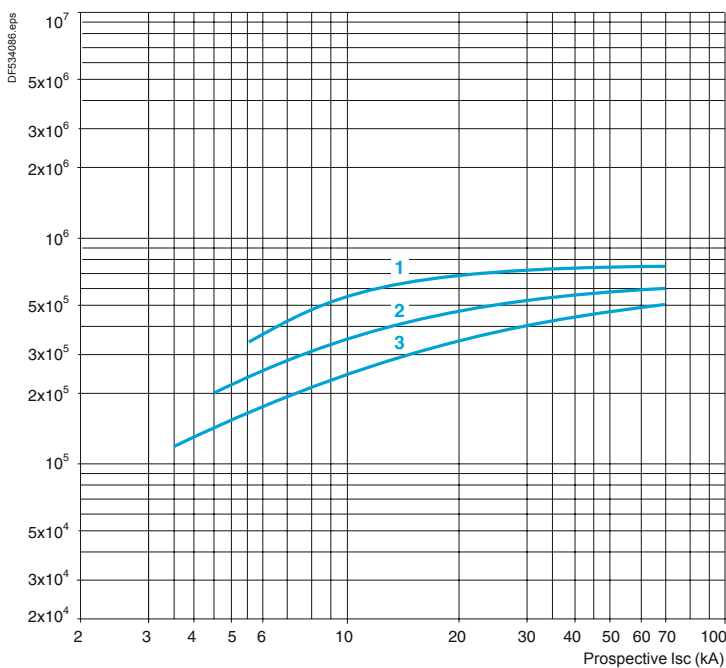

- 1 GV7 RS220
- 2 GV7 RS150
- 3 GV7 RS100

#### TeSys GV

#### Current limitation on short-circuit (3-phase 690 V)

##### Dynamic stress

$I_{peak} = f(\text{prospective } I_{sc})$

##### For GV7 RE only

Limited peak current (kA)

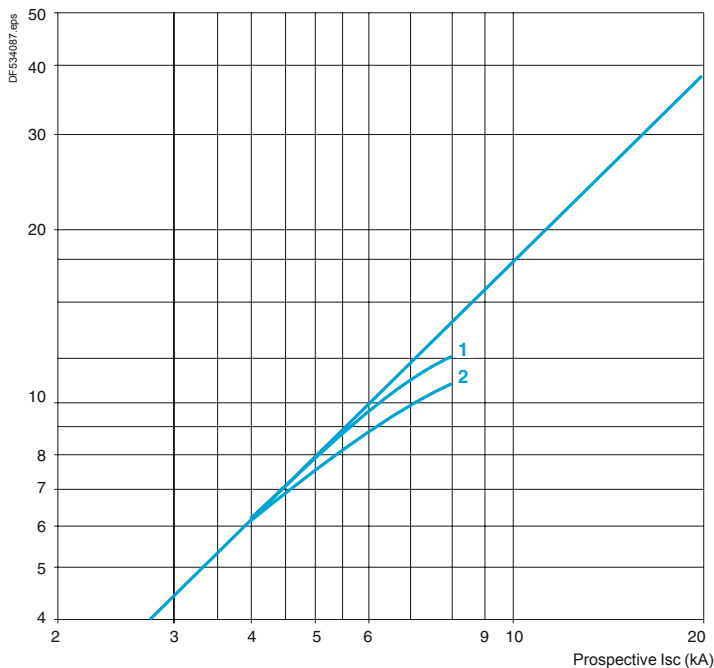

- 1 GV7 RE220
- 2 GV7 RE150 and GV7 RE100

##### For GV7 RS only

Limited peak current (kA)

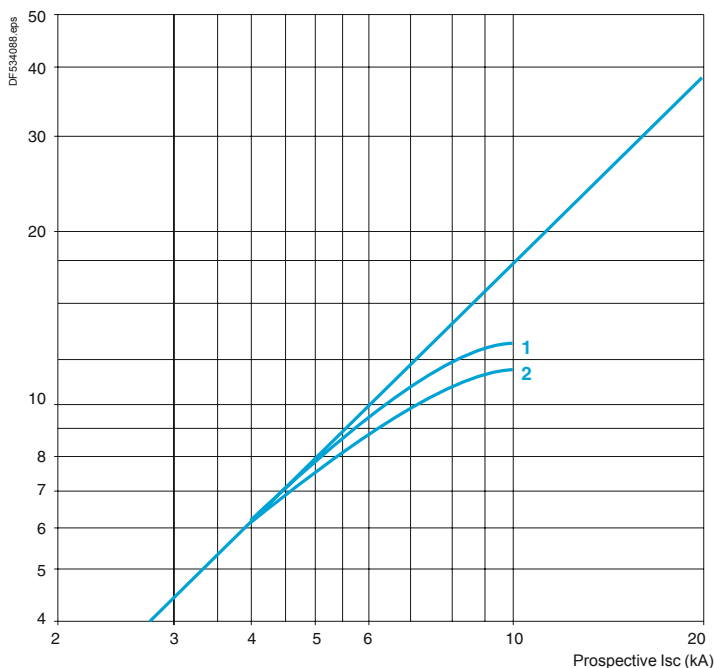

- 1 GV7 RS220
- 2 GV7 RS150 and GV7 RS100

#### TeSys GV

#### Thermal limit on short-circuit (3-phase 690 V)

##### Thermal limit

Sum of  $I^2dt = f$  (prospective I<sub>sc</sub>)

##### For GV7 RE only

Sum of  $I^2dt$  (A<sup>2</sup>s)

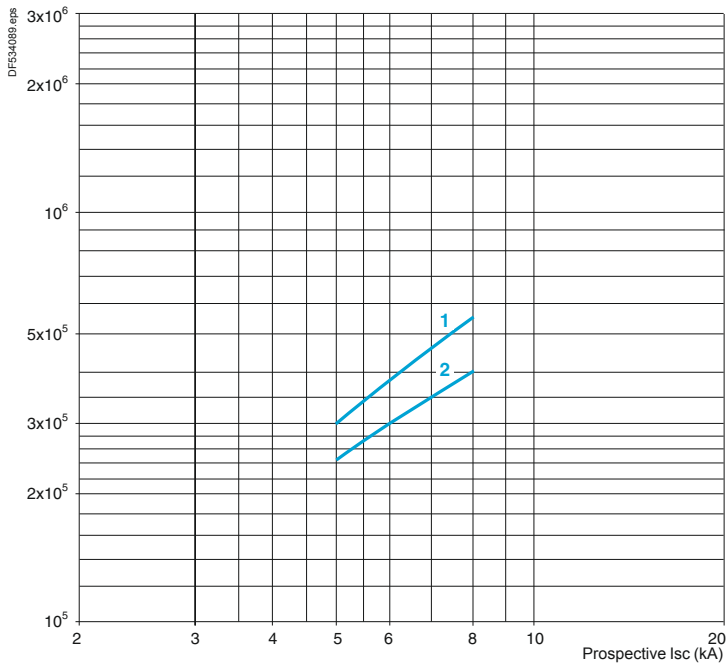

- 1 GV7 RE220
- 2 GV7 RE150 and GV7 RE100

##### For GV7 RS only

Sum of  $I^2dt$  (A<sup>2</sup>s)

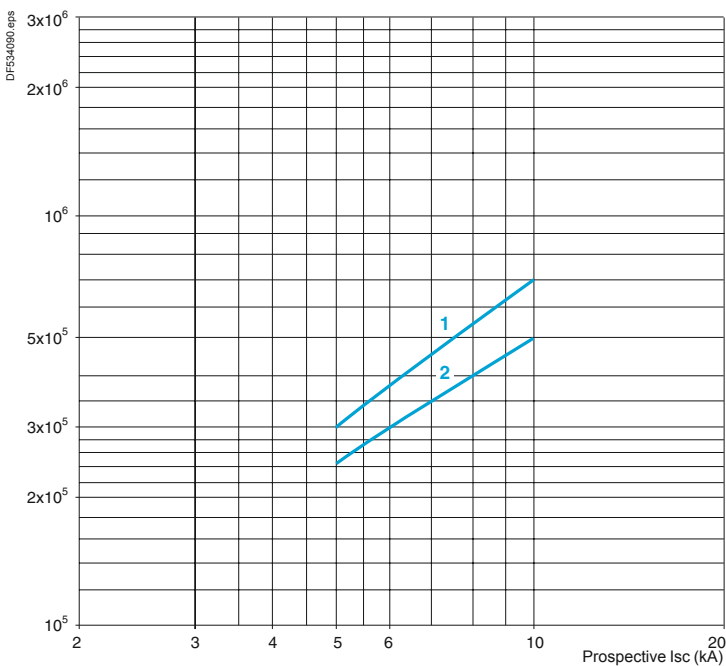

- 1 GV7 RS220
- 2 GV7 RS150 and GV7 RS100

**Thermal-magnetic tripping curves for GV2 RT**

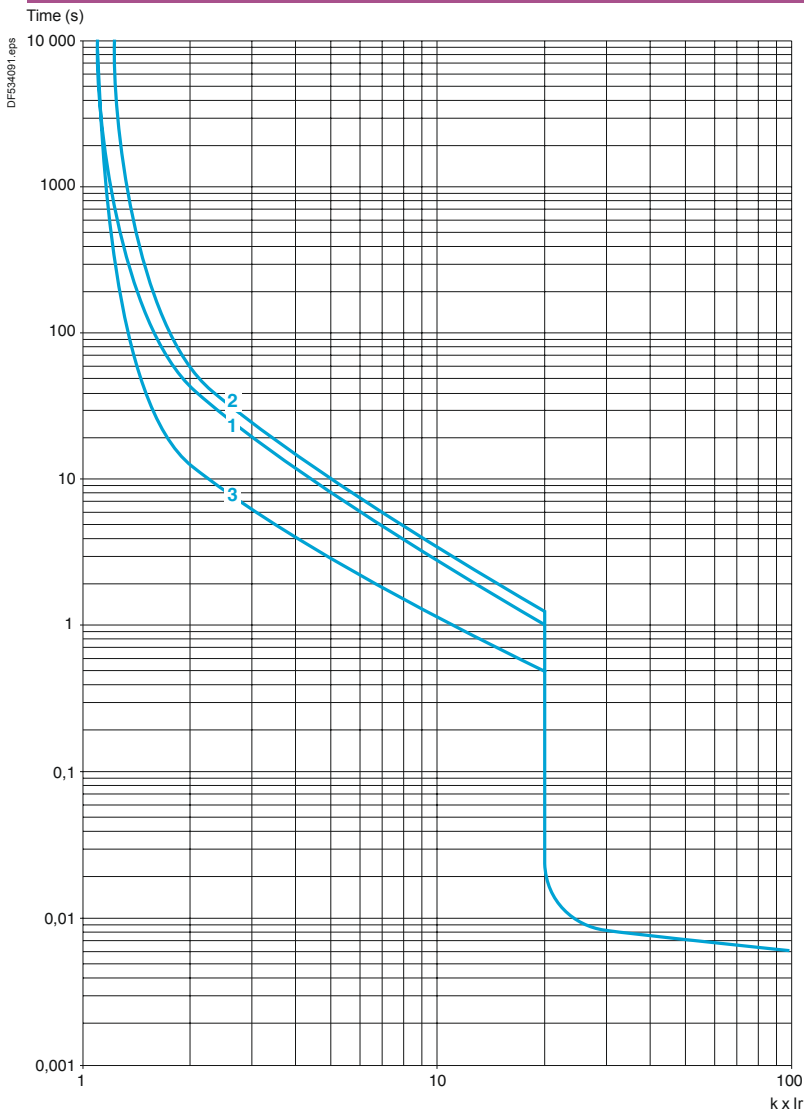

- 1 3 poles from cold state
- 2 2 poles from cold state
- 3 3 poles from hot state

TeSys GV

**Dimensions**

**GV2 ME**

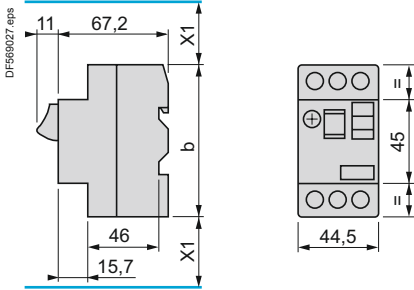

**GV AX**

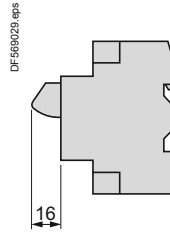

**GV AD, AM, AN, AU, AS, AX**

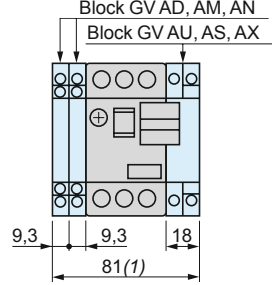

**GV AE**

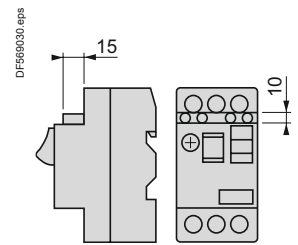

**b**

<b>GV2 ME●●</b>	89
<b>GV2 ME●●3</b>	101

(1) Maximum.  
X1 Electrical clearance = 40 mm for  $U_e \leq 690$  V

**GV2 P**

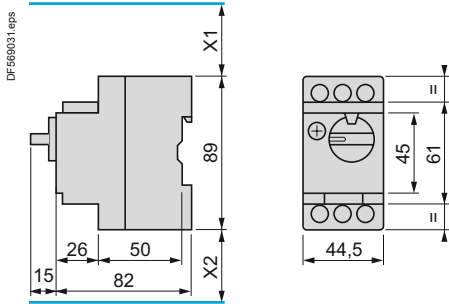

**GV AD, AM, AN, AU, AS**

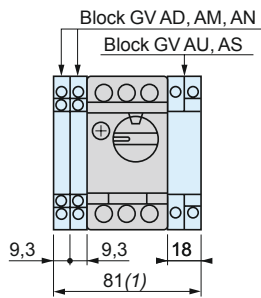

**GV2 AK00**

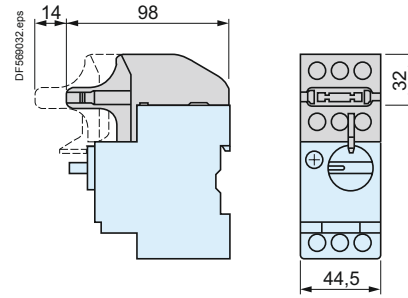

(1) Maximum.  
X1 Electrical clearance = 40 mm for  $U_e \leq 415$  V, or 80 mm for  $U_e = 440$  V, or 120 mm for  $U_e = 500$  and 690 V  
X2 = 40 mm

**GV2 GH7**

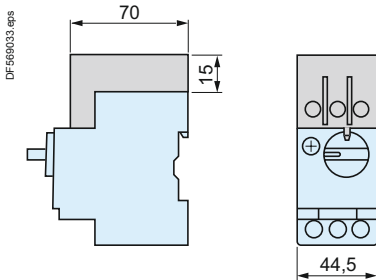

# TeSys protection components

## Thermal-magnetic motor circuit breakers

### GV2 ME and GV2 P

#### TeSys GV

#### Mounting

##### GV2 ME

On 35 mm rail

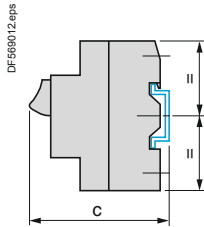

On panel with adapter plate GV2 AF02

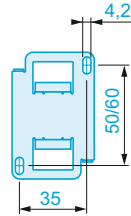
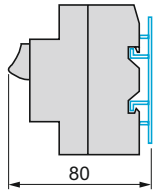

On pre-slotted plate AM1 PA

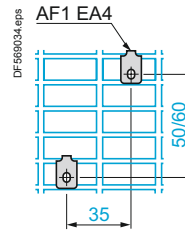

On rails DZ5 MB201

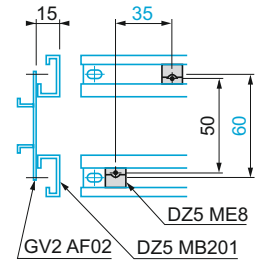

$c = 78.5$  on AM1 DP200 (35 x 7.5)  
 $c = 86$  on AM1 DE200, ED200 (35 x 15)

##### GV2 P

On rail AM1 DE200, ED200 (35 x 15)

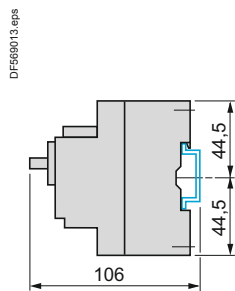

Panel mounted

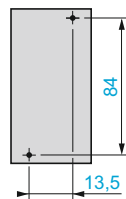

On pre-slotted plate AM1 PA

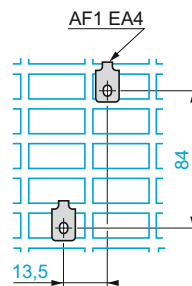

Adapter plate GK2 AF01

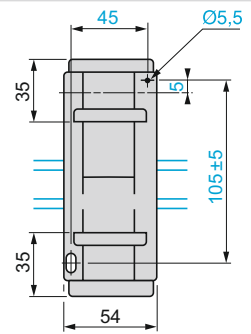
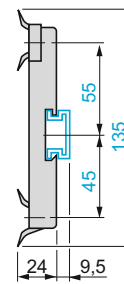

#### Dimensions

##### GV2 AF01

Combination GV2 ME + TeSys k contactor

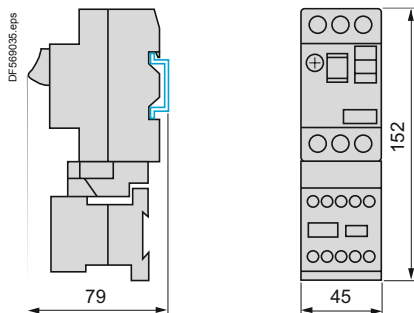

##### GV2 AF3

Combination GV2 ME + TeSys d contactor

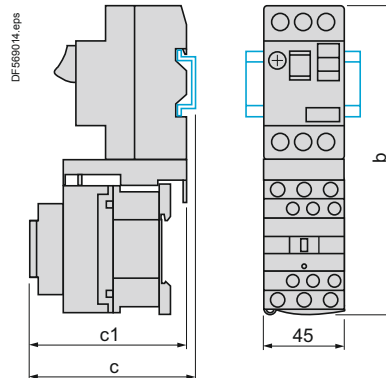

Combination GV2 P + TeSys d contactor

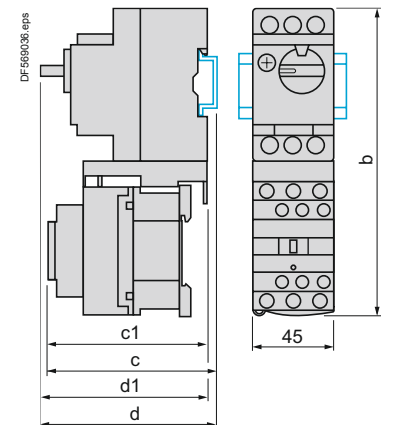

GV2 ME +	LC1 D09 ...D18	LC1 D25 and D32
b	176.4	186.8
c1	94.1	100.4
c	99.6	105.9

GV2 P +	LC1 D09 ...D18	LC1 D25 and D32
b	176.4	186.8
c1	100.1	106.4
c	105.6	111.9
d1	95	95
d	100.5	100.5

TeSys GV

**Dimensions**

**GV2 AF4 + LAD 311**

**Combination GV2 ME + TeSys d contactor**

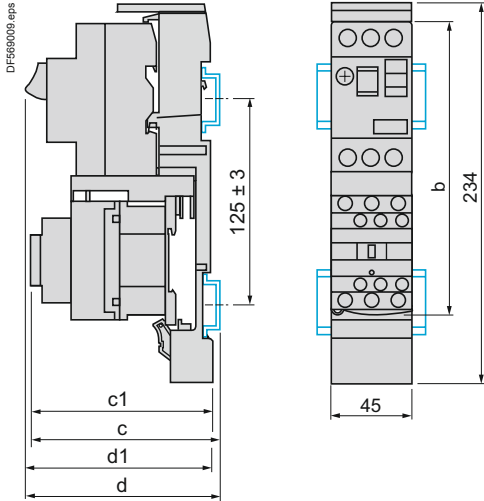

**Combination GV2 P + TeSys d contactor**

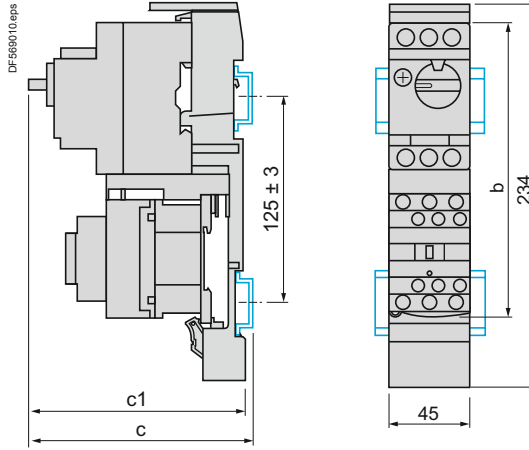

GV2 ME +	LC1 D09...D18	LC1 D25 and D32
<b>b</b>	176.4	186.8
<b>c1</b>	103.1	136.4
<b>c</b>	135.6	141.9
<b>d1</b>	107	107
<b>d</b>	112.5	112.5

GV2 P +	LC1 D09...D18	LC1 D25 and D32
<b>b</b>	176.4	186.8
<b>c1</b>	136.5	142.4
<b>c</b>	141.6	147.9

**GV2 ME + GV1 L3 (current limiter)**

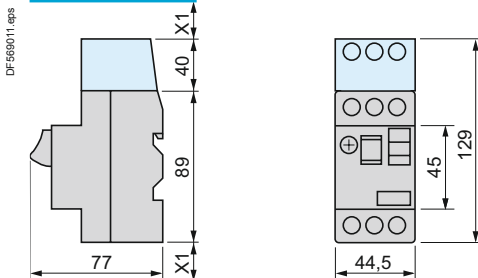

X1 = 10 mm for Ue = 230 V  
or 30 mm for 230 V < Ue ≤ 690 V

**7.5 mm height compensation plate GV1 F03**





### TeSys GV

#### Mounting

##### Mounting of external operator GV2 APN01, GV2 APN02 or GV2 APN04 for motor circuit breakers GV2 P

###### Door cut-out

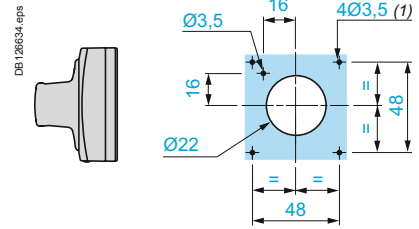
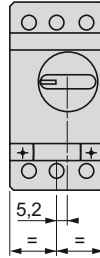
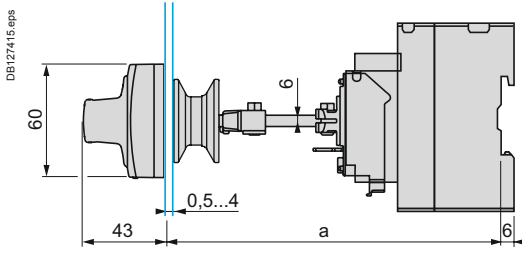

(1) For IP65 only.

##### Mounting of external operator GV APH02 for motor circuit breakers GV2 P

###### Door cut-out

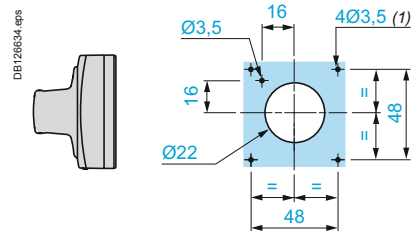
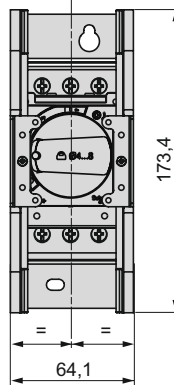
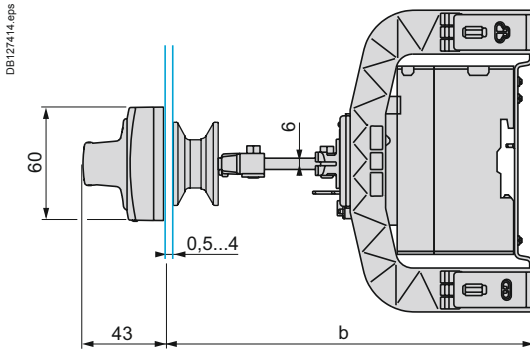

(1) For IP65 only.

	a		b	
	Mini	Maxi	Mini	Maxi
GV2 APN●●	140	250		
GV2 APN●● + GV APH02			151	250
GV2 APN●● + GV APK11	250	434	-	-
GV2 APN●● + GV APH02 + GV APK11	-	-	250	445

### TeSys GV

#### GV2 ME, GV2 P

Sets of busbars GV2 G445, GV2 G454, GV2 G472, with terminal block GV2 G05

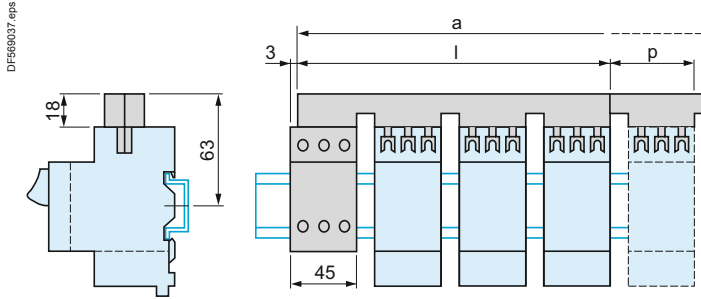

	l	p
GV2 G445 (4 x 45 mm)	179	45
GV2 G454 (4 x 54 mm)	206	54
GV2 G472 (4 x 72 mm)	260	72

Number of tap-offs	a			
	5	6	7	8
GV2 G445	224	269	314	359
GV2 G454	260	314	368	422
GV2 G472	332	404	476	548

#### Sets of busbars GV2 G●●● with terminal block GV1 G09

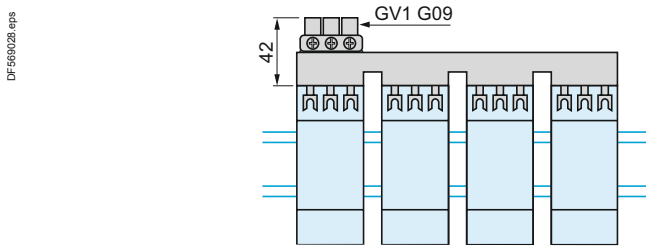

	l
GV2 G245 (2 x 45 mm)	89
GV2 G254 (2 x 54 mm)	98
GV2 G272 (2 x 72 mm)	116

#### Sets of busbars GV2 G245, GV2 G254, GV2 G272

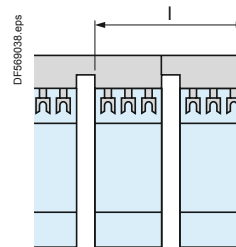

#### Sets of busbars GV2 G554

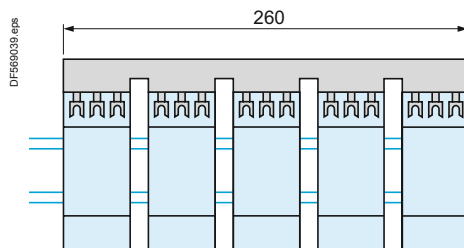

	l
GV2 G345 (3 x 45 mm)	134
GV2 G354 (3 x 54 mm)	152

#### Sets of busbars GV2 G345 and GV2 G354

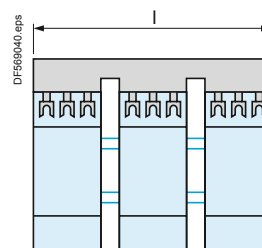

## TeSys GV

### GV2 RT

#### Dimensions

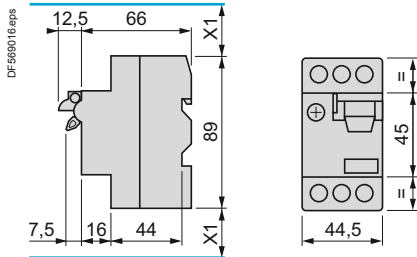

X1: Electrical clearance = 40 mm for  $U_e < 690 V$

#### Mounting

##### Mounting of external operator GV2 AP03

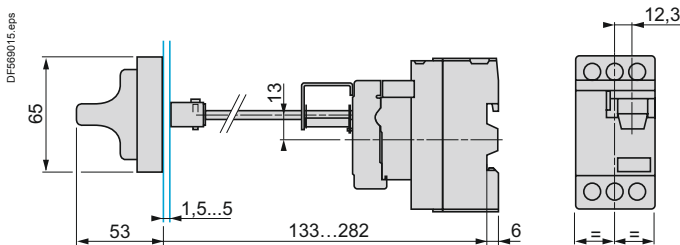

##### On 35 mm rail

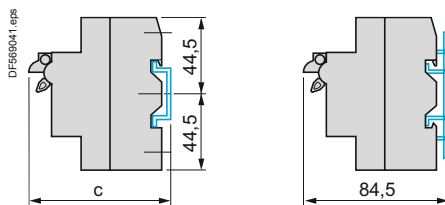

$c = 80$  on AM1 DP200 (35 x 7.5)  
 $c = 88$  on AM1 DE200, ED200 (35 x 15)

##### On panel with adapter plate GV2 AF02

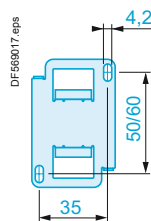

##### On pre-slotted plate AM1 PA

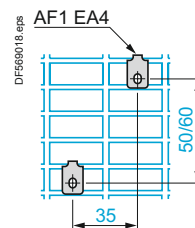

##### On rails DZ5 MB

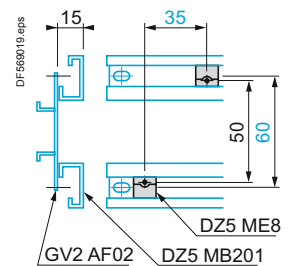

## TeSys GV

### GV3 P

#### Dimensions

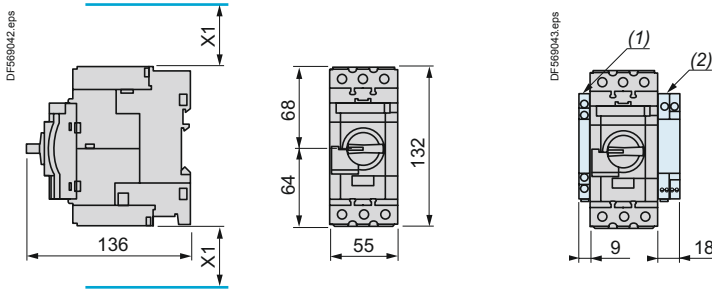

$X1$  = Electrical clearance (ISC max)  
40 mm for  $U_e \leq 500$  V, 50 mm for  $U_e \leq 690$  V

(1) Blocks GV AN●●, GV AD●● and GV AM11.  
(2) Blocks GV3 AU●● and GV3 AS●●.

**Note:** Leave a gap of 9 mm between 2 circuit breakers: either an empty space or side-mounting add-on contact blocks.  
Horizontal mounting is possible up to 40 °C.

#### Mounting

##### Mounting with TeSys contactor LC1 D40A...D65A

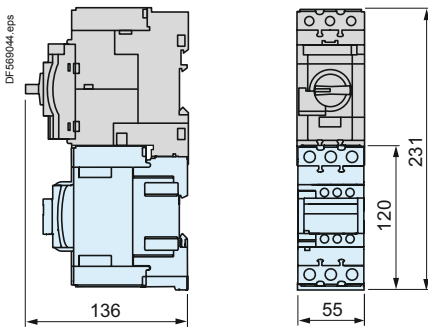

##### Side by side mounting with TeSys contactor LC1 D40A...D65A (S-shape busbar system GV3 S)

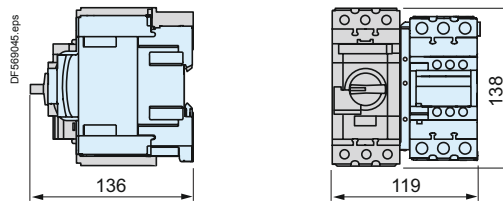

##### Mounting on rail AM1 DE200 or AM1 ED201

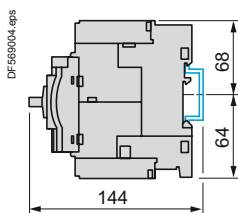

##### Panel mounting, using M4 screws

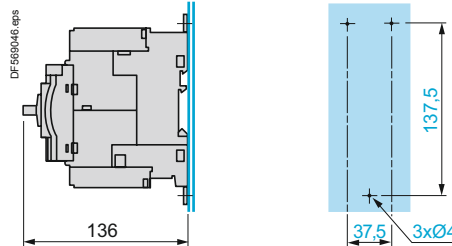

##### Mounting on pre-slotted plate AM1 PA

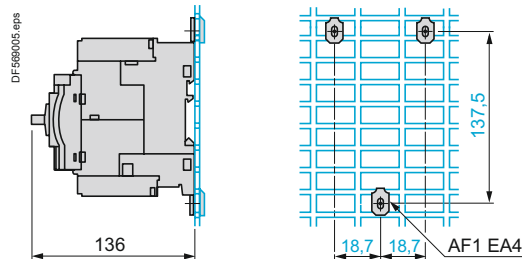

## TeSys GV

### GV3 P

#### Busbar systems

##### Set of busbars GV3 G264

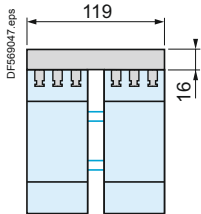

##### Set of busbars GV3 G364

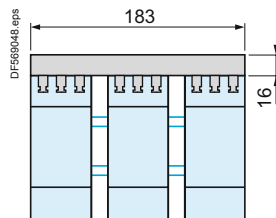

**Note:** Leave a space of 9 mm between 2 circuit breakers: either an empty space or side-mounting add-on contact blocks. Horizontal mounting is possible up to 40 °C.

### Mounting

#### Mounting of external operator GV3 APN01, GV3 APN02 or GV3 APN04 for motor circuit breakers GV3 P

##### Door cut-out

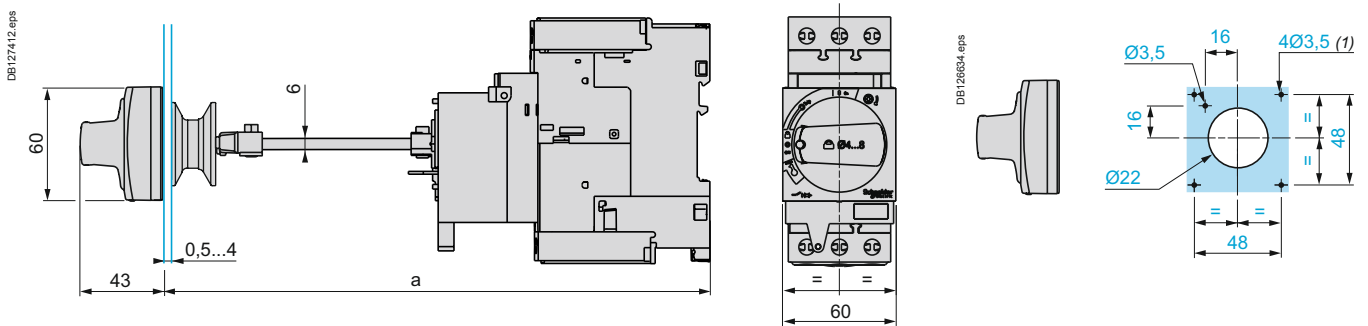

(1) For IP65 only.

#### Mounting of external operator GV APH03 for motor circuit breakers GV3 P

##### Door cut-out

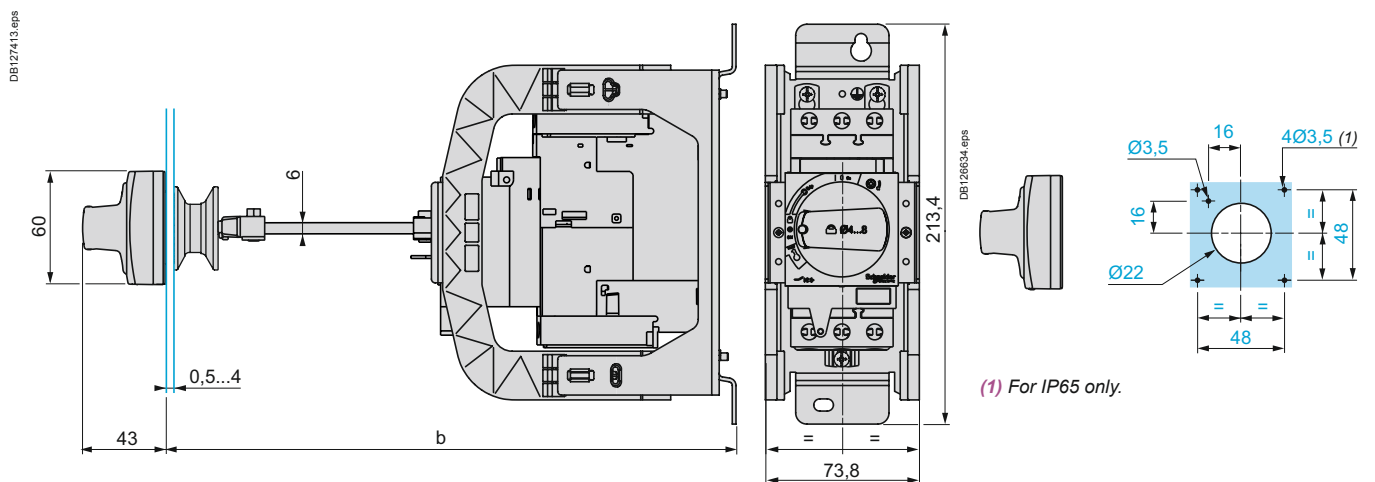

(1) For IP65 only.

	a		b	
	Mini	Maxi	Mini	Maxi
GV3 APN●●	189	300	-	-
GV3 APN●● + GV APK12	300	481	-	-
GV3 APN●● + GV APH03	-	-	200	300
GV3 APN●● + GV APH03 + GV APK12	-	-	300	492

#### GV3 ME80

#### Dimensions

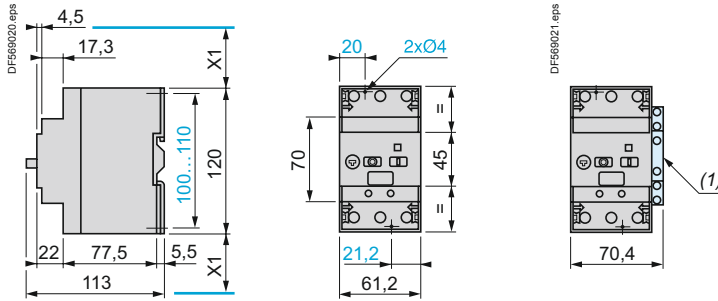

X1 = Electrical clearance (ISC max)  
40 mm for  $U_e \leq 500$  V, 50 mm for  $U_e \leq 690$  V

(1) Blocks GV3 A01...A07.

#### Mounting

Mounting on rail AM1 DE200 or AM1 ED201

Panel mounting, using M4 screws

Mounting on pre-slotted plate AM1 PA

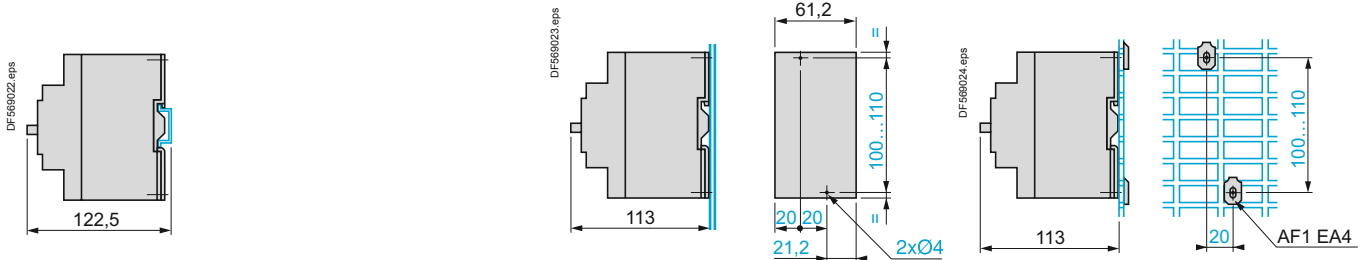

### TeSys GV

#### GV7 R

#### Dimensions

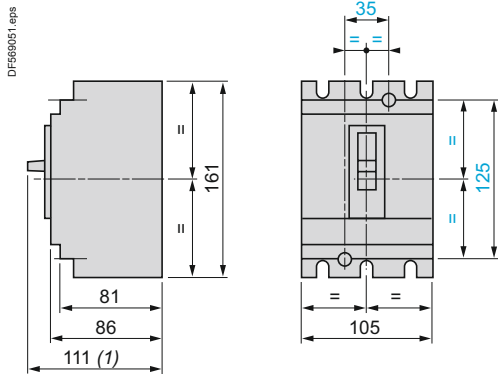

(1) 126 for **GV7 R●220**.

#### Motor circuit breakers with terminal shields or phase barriers GV7 R + GV7 AC01 or AC04

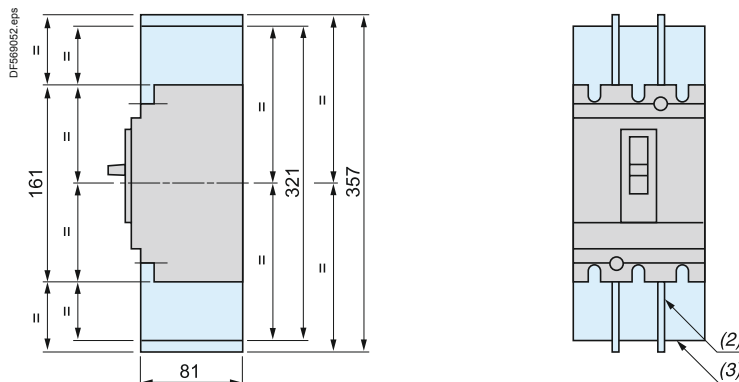

(2) Phase barriers: **GV7 AC04**.  
(3) Terminal shields: **GV7 AC01**.

#### Combination of GV7 R and TeSys contactor LC1 F with kit GV7 AC0●

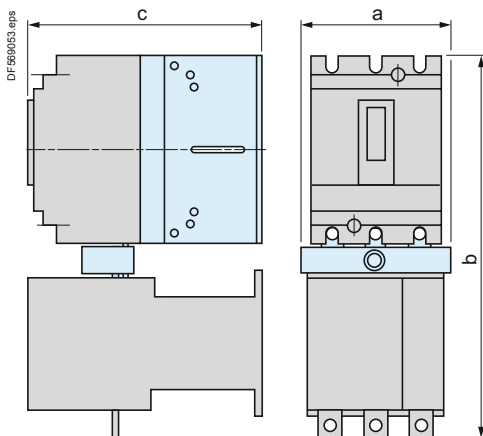

	a	b	c
GV7 R + LC1 F115 or F150 + GV7 AC06	119	334	181
GV7 R + LC1 F185 + GV7 AC06	119	338	188
GV7 R + LC1 F225 + GV7 AC07	131	358	188
GV7 R + LC1 F265 + GV7 AC07	131	364	215

Minimum distance between 2 circuit breakers mounted side by side = 0

#### Minimum electrical clearance

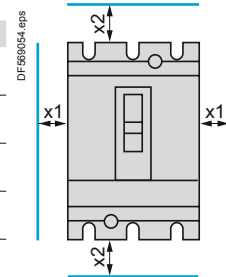

	x1	x2
Painted or insulated metal plate, insulation or insulated bar	0	30
Bare metal plate	$U \leq 440$ V	5
	$440$ V < $U$ < $600$ V	10
	$U \geq 600$ V	20

# TeSys protection components

## Thermal-magnetic motor circuit breakers

### GV7 R

#### TeSys GV

#### GV7 R

##### Panel mounting

##### Mounting on 2 mounting rails DZ5 MB201

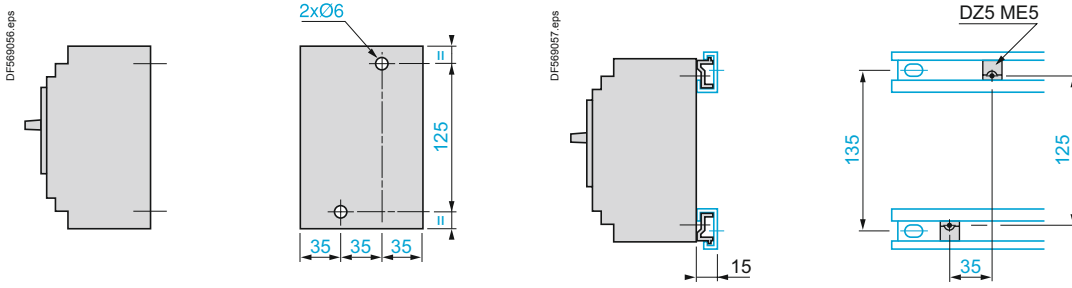

##### Flush-mounting

##### 1 circuit breaker GV7 R

##### n circuit breakers GV7 R side by side

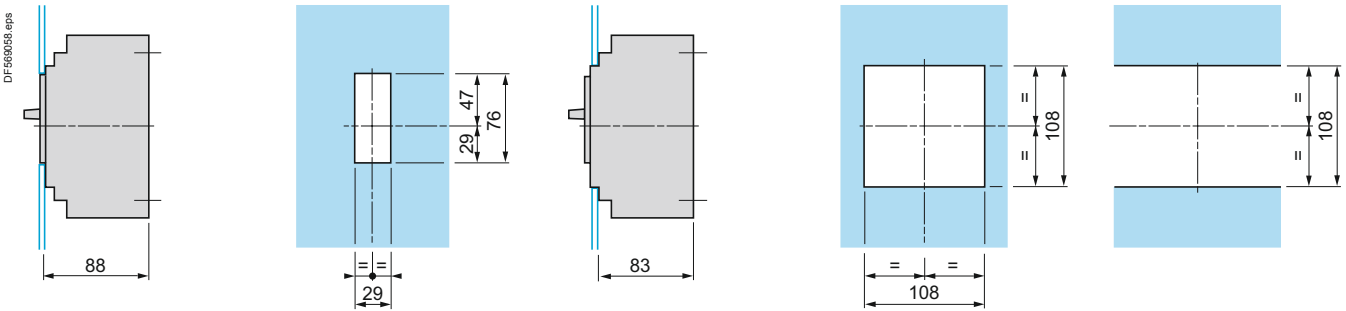

##### Combination of GV7 R and TeSys contactor LC1 F with kit GV7 AC0●

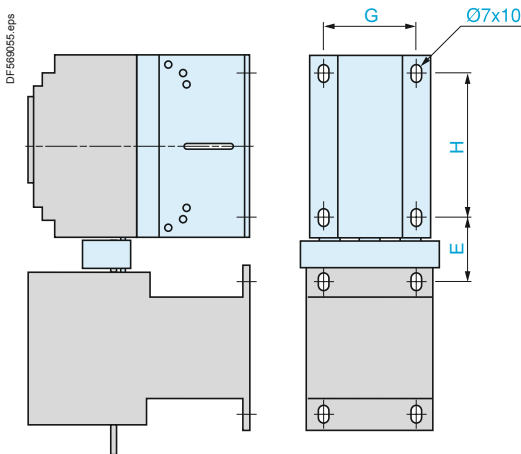

	E	G	H
GV7 R + LC1 F115 + GV7 AC06	44	85	120
GV7 R + LC1 F150 + GV7 AC06	46	85	120
GV7 R + LC1 F185 + GV7 AC06	48	85	120
GV7 R + LC1 F225 + GV7 AC07	57	85	120
GV7 R + LC1 F265 + GV7 AC07	60	85	120



#### TeSys GV

#### GV7 R

##### Spreaders GV7 AC03

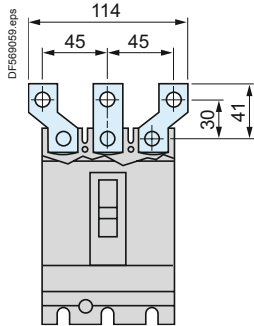

##### Connection

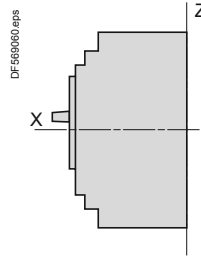

##### Smooth terminals

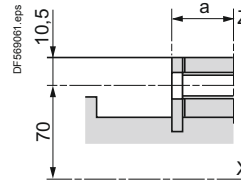

##### Connectors

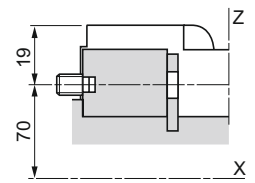

	a
GV7 R $\bullet$ 40...R $\bullet$ 150	19.5
GV7 R $\bullet$ 220	21.5

##### Direct rotary handle GV7 AP03, GV7 AP04

##### Flush-mounting

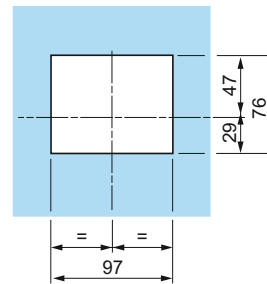
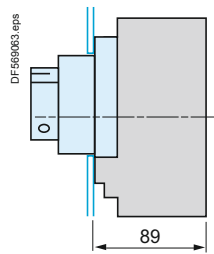
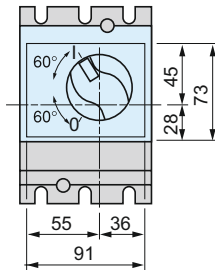
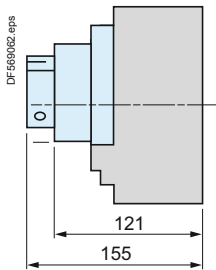

##### Direct rotary handle GV7 AP03 or GV7 AP04 with conversion accessory GV7 AP05

##### Front face cut-out

##### Enclosure viewed from top

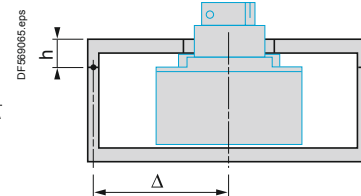
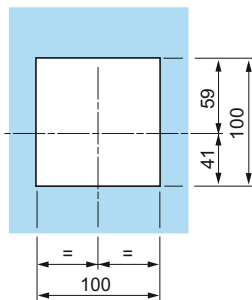
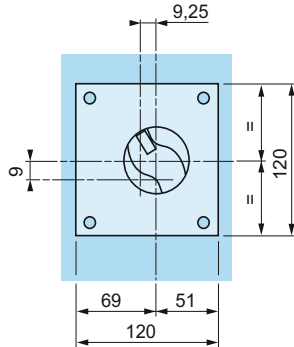
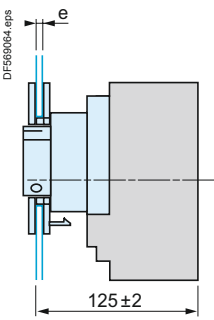

Door cut-outs require a minimum distance between the centre of the circuit breaker and the door hinge point  $\Delta \geq 100 + (h \times 5)$

e = 1 to 3 max

##### Extended rotary handle GV7 AP01, GV7 AP02

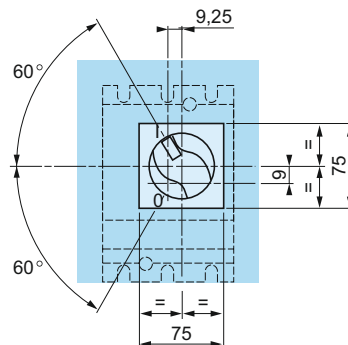
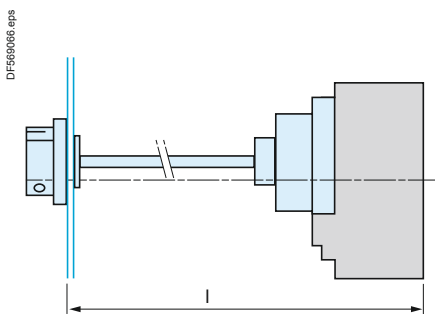

l: 185 min, 600 max

The shaft of the extended rotary handle GV7 AP01 or GV7 AP02 must be cut to length: l – 126 mm.

## TeSys GV

### Schemes

#### GV2 ME●● and GV2 RT

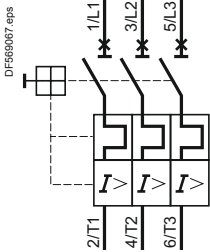

#### GV2 P●●

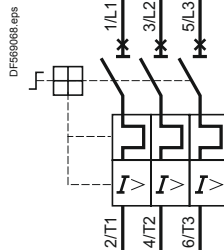

#### GV3 P●●

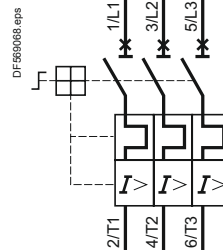

#### Front mounting add-on contact blocks Instantaneous auxiliary contacts

##### GV AE1

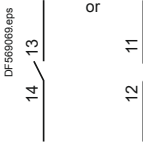

##### GV AE11

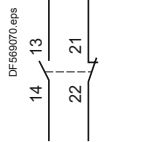

##### GV AE20

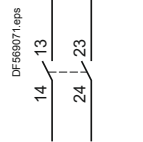

#### Front mounting add-on contact blocks Instantaneous auxiliary contacts and fault signalling contacts

##### GV AED101

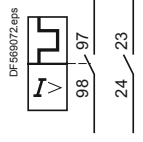

##### GV AED011

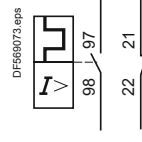

#### Side mounting add-on contact blocks Instantaneous auxiliary contacts and fault signalling contacts

##### GV AD0110

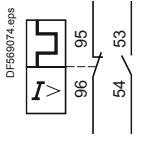

##### GV AD0101

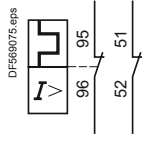

##### GV AD1010

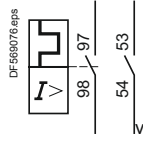

##### GV AD1001

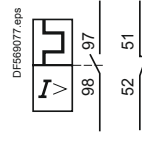

#### Instantaneous auxiliary contacts

##### GV AN11

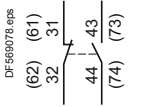

##### GV AN20

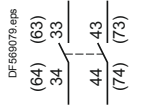

#### Short-circuit signalling contacts

##### GV AM11

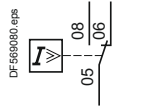

#### Voltage trips

##### GV AU●●●

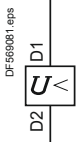

##### GV AS●●●

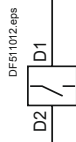

##### GV AX●●●

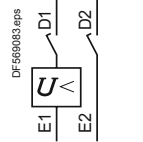

#### Current limiter

##### GV1 L3

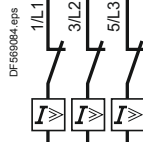

#### Use of fault signalling contact and short-circuit signalling contact

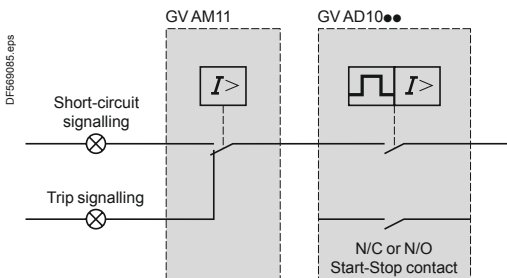

#### Connection of undervoltage trip for dangerous machines (conforming to INRS) on GV2 ME only

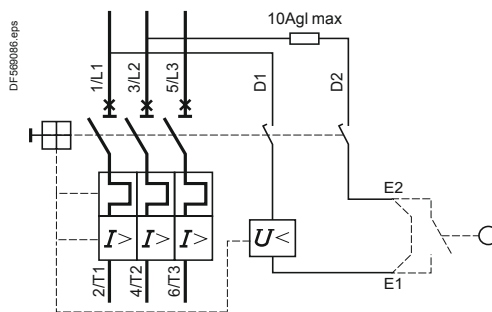

### TeSys GV

#### Schemes

##### Motor circuit breakers

###### GV3 ME80

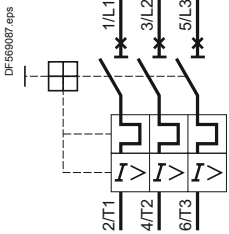

##### Auxiliary contact block modules

###### GV3 A01



###### GV3 A02



###### GV3 A03



###### GV3 A05



###### GV3 A06



###### GV3 A07

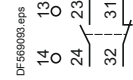

##### Fault signalling contacts

###### GV3 A08

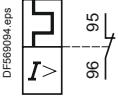

###### GV3 A09

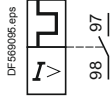

##### Voltage trips

###### GV3 B



###### GV3 D



##### Motor circuit breakers

###### GV7 R

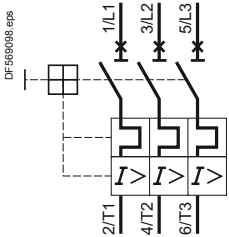

##### Add-on auxiliary contacts according to their location (1)

###### GV7 AE11, GV7 AB11

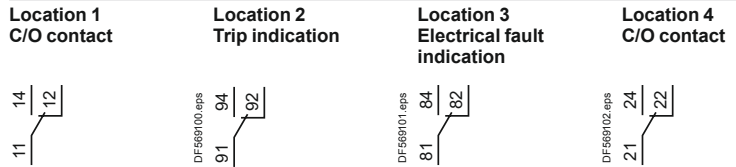

A self-adhesive label, supplied with the contact, can be affixed to the front face of the circuit-breaker to allow personalised marking according to the function of the contact or contacts.  
 (1) See pages B6/91 and B6/17.

##### Electric trips

###### GV7 AU●●●

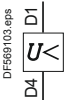

###### GV7 AS●●●



###### GV7 AD111, AD112

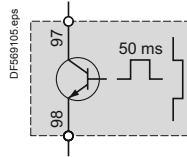

##### Recommended application schemes GV7 AD111, AD112

###### Fault indication

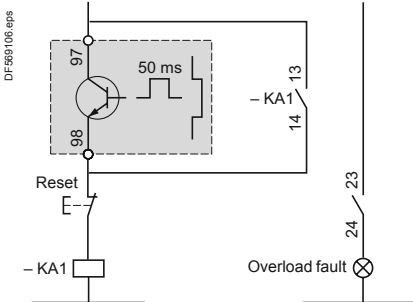

###### Contact opening on overload

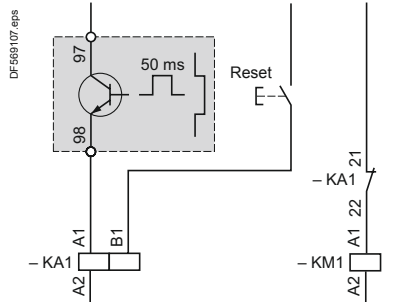

Associated components  
 KA1: CA2 KN or CAD N

Associated components  
 KA1: CAD + LAD 6K10 or RHK  
 KM1: LC1 D or LC1 F

# Protection components

## Thermal-magnetic circuit breakers

### TeSys GB2 for the protection of industrial equipment control circuits

#### Presentation

GB2 thermal-magnetic circuit breakers protect and isolate the control circuits of industrial equipment with contactor coils, transformers....

They protect and isolate single-phase auxiliary circuits such as solenoid valves, electro-brakes, battery chargers, supplied from the control circuit voltage.

#### GB2 CB, GB2 CD, GB2 DB

12 ratings are available, from 0.5 to 20 A, in single-pole (GB2 CB), single-pole + neutral (GB2 CD) and 2-pole (GB2 DB) versions.

They have a magnetic tripping threshold set at between 12 and 16 I<sub>n</sub> to withstand the current peaks generated by many industrial components.

#### GB2 CS

2 ratings are available, 0.5 and 1 A, in single-pole version.

The magnetic tripping threshold is set between 5 and 7 I<sub>n</sub>.

#### Functions, installation

Clip-on fixing onto all types of 35 mm  $\perp$  rails, on  $\perp$  rails and on Telequick mounting plates.

Upstream and downstream marking by means of AB1 clip-in markers.

Clear indication of "I" and "O" positions on the operator.

Tamper-proof device which requires no special maintenance (fixed magnetic and thermal tripping thresholds).

#### Selection for the protection of circuits supplied by transformers

Single-phase transformers.

Magnetising peak: 20 I<sub>n</sub>.

Operation of magnetic trips: 13 I<sub>n</sub>.

Power VA	Primary <sup>(1)</sup>		Secondary			
	220/240 V	380/415 V	24 V	48 V	110 V	220 V
40	GB2 DB05	GB2 DB05	GB2 CD07	GB2 CD06	GB2 CD05	GB2 CD05
63	GB2 DB05	GB2 DB05	GB2 CD08	GB2 CD07	GB2 CD06	GB2 CD05
100	GB2 DB06	GB2 DB05	GB2 CD10	GB2 CD07	GB2 CD06	GB2 CD05
160	GB2 DB07	GB2 DB06	GB2 CD14	GB2 CD09	GB2 CD07	GB2 CD06
250	GB2 DB07	GB2 DB06	GB2 CD16	GB2 CD12	GB2 CD08	GB2 CD07
400	GB2 DB08	GB2 DB07	GB2 CD22	GB2 CD14	GB2 CD09	GB2 CD07
630	GB2 DB10	GB2 DB08	–	GB2 CD21	GB2 CD12	GB2 CD08
1000	GB2 DB14	GB2 DB09	–	–	GB2 CD16	GB2 CD10
1600	GB2 DB20	GB2 DB14	–	–	–	GB2 CD14
2000	GB2 DB21	GB2 DB14	–	–	GB2 CD22	GB2 CD16
2500	GB2 DB22	GB2 DB20	–	–	–	GB2 CD20
3000	GB2 DB22	GB2 DB20	–	–	–	GB2 CD21
4000	–	GB2 DB21	–	–	–	GB2 CD22
5000	–	GB2 DB22	–	–	–	–

<sup>(1)</sup> If the breaking capacity of the GB2 is insufficient, use a GV2 RT with 2 poles connected in series, see page B6/8.

# Protection components

## Thermal-magnetic circuit breakers

### TeSys GB2 for the protection of industrial equipment control circuits

TeSys GB

Environment		GB2 CB	GB2 CD	GB2 DB	GB2 CS
<b>Circuit breaker type</b>		IEC 60947-1, 947-2, EN 60947-1, 60947-2			
Conforming to standards		IEC 60947-1, 947-2, EN 60947-1, 60947-2			
Product certifications		CSA, NEMKO, UL	NEMKO, UL	-	-
Protective treatment		"TC"			
Degree of protection	Conforming to IEC 60529	IP 20			
Shock resistance	Conforming to IEC 60068-2-27	22 gn for 20 ms			
Vibration resistance	Conforming to IEC 60068-2-6	5 gn (5...110 Hz)			
Ambient air temperature around the device	Storage	°C -40...+80			
	Operation	°C -20...+60			
Flame resistance	Conforming to IEC 60695-2-1	°C 960			
Maximum operating altitude		m 3000			
Operating position	In relation to normal vertical mounting plane				
Cabling	Solid cable	<b>mm<sup>2</sup></b>	<b>Minimum c.s.a.</b> 1 x 0.75	<b>Maximum c.s.a.</b> 1 x 6 or 2 x 4	
	Flexible cable with cable end	<b>mm<sup>2</sup></b>	1 x 0.75	1 x 4 or 2 x 2.5	
Tightening torque		<b>N.m</b>	1.2		

Technical characteristics			A	A	A	A					
Utilisation category	Conforming to IEC 60947-2		A	A	A	A					
Rated operational voltage (Ue)	Conforming to IEC 60947-2	<b>V</b>	250 <sup>(1)</sup>	250	415	250 <sup>(1)</sup>					
	Conforming to CSA C22-2 Nr 14 and UL 1077	<b>V</b>	277	-	277	-					
Rated operational frequency	Conforming to IEC 60947-2	<b>Hz</b>	50/60	50/60	50/60	50/60					
Rated impulse withstand voltage (U imp)	Conforming to IEC 60947-2	<b>kV</b>	4	4	4	4					
Total power dissipated per pole		<b>W</b>	2	2	2	1.9					
Mechanical and electrical durability	C.O.: Closing - Opening	<b>C.O.</b>	8000	8000	8000	8000					
Operational current correction coefficient (a or ---)	According to the permissible ambient temperature	<b>°C</b>	-20	-10	0	+10	+20	+30	+40	+50	+60
	Correction coefficient		1.2	1.15	1.1	1.05	1	0.95	0.90	0.85	0.80
Tripping threshold	Of the magnetic trips		12...16 I <sub>n</sub>		12...16 I <sub>n</sub>		12...16 I <sub>n</sub>		5...7 I <sub>n</sub>		

(1) Ue = 415 V when a GB2 circuit breaker is fitted on every live conductor.

#### Tripping curves

Average operating time at 20 °C without prior current flow (cold state)

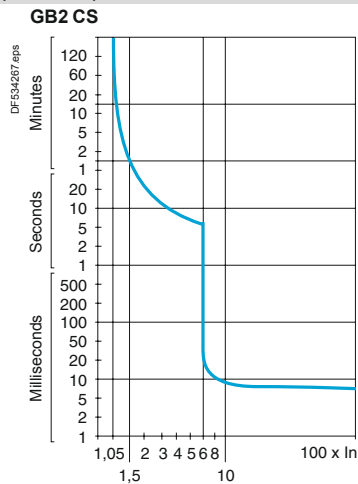
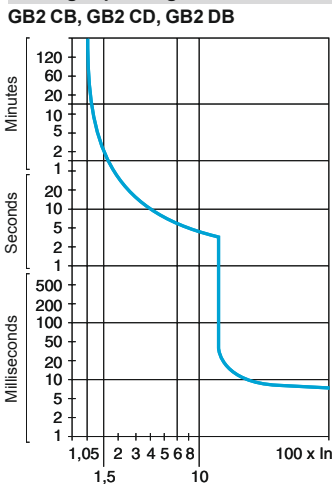

# Protection components

## Thermal-magnetic circuit breakers

### TeSys GB2 for the protection of industrial equipment control circuits

TeSys GB

Circuit breaker type			GB2												
			CB05	CB06	CB07	CB08	CB09	CB10	CB12	CB14	CB16	CB20	CB21	CB22	
Rating		A	0.5	1	2	3	4	5	6	8	10	12	16	20	
Breaking capacity conforming to IEC 60947-2 ~ 50/60 Hz	110 V	Icu	kA	50	50	15	10	6	3	3	3	2	2	2	
		Ics % <sup>(1)</sup>		100	50	50	50	50	75	75	75	75	75	75	75
	230/240 V	Icu	kA	50	50	15	3	3	2	1.5	1.5	1.5	1.5	1.5	
		Ics % <sup>(1)</sup>		25	25	25	50	50	75	75	75	75	75	75	75
Associated fuses, if required if Isc > breaking capacity Icu conforming to IEC 60947-2	110 V	aM	A	*	*	20	25	25	40	40	50	50	63	63	
		gG	A	*	*	25	32	32	50	50	63	63	80	80	
	230/240 V	aM	A	*	*	16	20	20	32	32	40	40	50	50	
		gG	A	*	*	25	32	32	40	40	50	50	63	63	

Circuit breaker type			GB2												
			CD05	CD06	CD07	CD08	CD09	CD10	CD12	CD14	CD16	CD20	CD21	CD22	
Rating		A	0.5	1	2	3	4	5	6	8	10	12	16	20	
Breaking capacity conforming to IEC 60947-2 ~ 50/60 Hz	110 V	Icu	kA	50	50	15	10	6	3	3	3	2	2	2	
		Ics % <sup>(1)</sup>		100	50	50	50	50	75	75	75	75	75	75	75
	230/240 V	Icu	kA	50	50	15	3	3	2	1.5	1.5	1.5	1.5	1.5	
		Ics % <sup>(1)</sup>		25	25	25	50	50	75	75	75	75	75	75	75
Associated fuses, if required if Isc > breaking capacity Icu conforming to IEC 60947-2	110 V	aM	A	*	*	20	25	25	40	40	50	50	63	63	
		gG	A	*	*	25	32	32	50	50	63	63	80	80	
	230/240 V	aM	A	*	*	16	20	20	32	32	40	40	50	50	
		gG	A	*	*	25	32	32	40	40	50	50	63	63	

Circuit breaker type			GB2												
			DB05	DB06	DB07	DB08	DB09	DB10	DB12	DB14	DB16	DB20	DB21	DB22	
Rating		A	0.5	1	2	3	4	5	6	8	10	12	16	20	
Breaking capacity conforming to IEC 60947-2 ~ 50/60 Hz	110 V	Icu	kA	50	50	15	10	6	3	3	3	2	2	2	
		Ics % <sup>(1)</sup>		100	50	50	50	50	75	75	75	75	75	75	75
	230/240 V	Icu	kA	50	50	15	3	3	2	1.5	1.5	1.5	1.5	1.5	
		Ics % <sup>(1)</sup>		25	25	25	50	50	75	75	75	75	75	75	75
	400/415 V	Icu	kA	50	50	15	3	3	2	1.5	1.5	1.5	1.5	75	
		Ics % <sup>(1)</sup>		25	25	25	50	50	75	75	75	75	75	1.5	75
Associated fuses, if required if Isc > breaking capacity Icu conforming to IEC 60947-2	110 V	aM	A	*	*	20	25	25	40	40	50	50	63	63	
		gG	A	*	*	25	32	32	50	50	63	63	80	80	
	230/240 V	aM	A	*	*	16	20	20	32	32	40	40	50	50	
		gG	A	*	*	25	32	32	40	40	50	50	63	63	
	400/415 V	aM	A	*	*	16	20	20	32	32	40	40	50	50	
		gG	A	*	*	25	32	32	40	40	50	50	63	63	

<sup>(1)</sup> As % of Icu.  
 \* Fuse not required. Breaking capacity Icu > Isc.

# Protection components

## Thermal-magnetic circuit breakers

### TeSys GB2 for the protection of industrial equipment control circuits

TeSys GB

Circuit breaker type				GB2																	
				●●05	●●06	●●07	●●08	●●09	●●10	●●12	●●14	●●16	●●20	●●21	●●22						
Breaking capacity (Icu) conforming to IEC 60947-2 ---	24 V	kA		1.5	1.5	1.5	1.5	1.5	1.5	1.5	1.5	1.5	1.5	1.5	1.5						
	48 V	kA		1	1	1	1	1	1	1	1	–	–	–	–						
Operational current conforming to IEC 60947-5-1 ---	DC-12	24 V	A	0.5	1	2	3	4	5	6	8	10	12	16	20						
		48 V	A	0.5	1	2	3	4	5	6	8	10	12	16	20						
	DC-13	24 V	A	0.5	1	2	3	4	5	6	8	10	12	16	20						
		48 V	A	0.5	1	2	3	4	5	6	8	–	–	–	–						
Circuit breaker type				GB2																	
Rating				CS05					CS06												
Breaking capacity conforming to IEC 60947-2 ~ 50/60 Hz	110 V	Icu	kA	50					50												
		Ics % <sup>(1)</sup>		100					100												
	230/240 V	Icu	kA	50					50												
Ics % <sup>(1)</sup>			25					25													
Breaking capacity (Icu) conforming to IEC 60947-2 ---	24 V	kA		1.5					1.5												
		48 V	kA		1					1											
Operational current conforming to IEC 60947-5-1 ---	DC-12	24 V	A	0.5					1												
		48 V	A	0.5					1												
	DC-13	24 V	A	0.5					1												
		48 V	A	0.5					1												
Maximum permissible line length for star-delta starting (length of cable containing 2 or more conductors)	With contactors LC● D09 ...D18	Operational voltage	V	48			110			230			48			110			230		
		C.s.a.	0.60 mm <sup>2</sup>	m	<sup>(3)</sup>	31			365			6			85			230			
	0.75 mm <sup>2</sup>		m	<sup>(3)</sup>	39			460			8			110			290				
	1 mm <sup>2</sup>		m	<sup>(3)</sup>	52			610			10			145			380				
	1.5 mm <sup>2</sup>		m	<sup>(3)</sup>	78			910			15			220			570				
	2.5 mm <sup>2</sup>		m	<sup>(3)</sup>	130			1520			26			360			950				
	4 mm <sup>2</sup>		m	<sup>(3)</sup>	200			2400			41			580			1500				
	With contactors LC● D25...D32	Operational voltage	V	48			110			230			48			110			230		
		C.s.a.	0.60 mm <sup>2</sup>	m	<sup>(3)</sup>	<sup>(3)</sup>			230			<sup>(3)</sup>			56			230			
	0.75 mm <sup>2</sup>		m	<sup>(3)</sup>	<sup>(3)</sup>			290			<sup>(3)</sup>			70			290				
	1 mm <sup>2</sup>		m	<sup>(3)</sup>	<sup>(3)</sup>			390			<sup>(3)</sup>			95			380				
	1.5 mm <sup>2</sup>		m	<sup>(3)</sup>	<sup>(3)</sup>			580			<sup>(3)</sup>			140			570				
	2.5 mm <sup>2</sup>		m	<sup>(3)</sup>	<sup>(3)</sup>			970			<sup>(3)</sup>			230			950				
	4 mm <sup>2</sup>		m	<sup>(3)</sup>	<sup>(3)</sup>			1500			<sup>(3)</sup>			375			1500				
	With contactors LC● D40...D80	Operational voltage	V	48			110			230			48			110			230		
		C.s.a.	0.60 mm <sup>2</sup>	m	<sup>(3)</sup>	<sup>(3)</sup>			46			<sup>(3)</sup>			13			100			
	0.75 mm <sup>2</sup>		m	<sup>(3)</sup>	<sup>(3)</sup>			60			<sup>(3)</sup>			17			130				
	1 mm <sup>2</sup>		m	<sup>(3)</sup>	<sup>(3)</sup>			80			<sup>(3)</sup>			22			170				
	1.5 mm <sup>2</sup>		m	<sup>(3)</sup>	<sup>(3)</sup>			120			<sup>(3)</sup>			34			250				
2.5 mm <sup>2</sup>	m		<sup>(3)</sup>	<sup>(3)</sup>			190			<sup>(3)</sup>			56			420					
4 mm <sup>2</sup>	m		<sup>(3)</sup>	<sup>(3)</sup>			310			<sup>(3)</sup>			90			680					

(1) As % of Icu.  
 (2) One GB2 CS circuit breaker on each live conductor.  
 (3) Use relays.

# Protection components

Thermal-magnetic circuit breakers TeSys GB2 for the protection of industrial equipment control circuits

TeSys GB

## Dimensions

GB2 CB●●, GB2 CD●●, GB2 CS●●

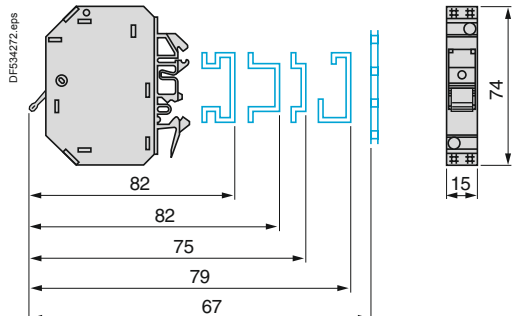

GB2 DB●●

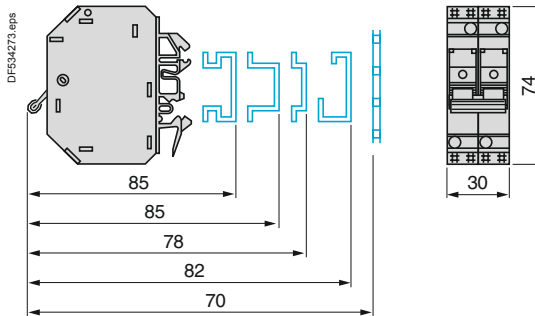

Marking: up to twelve AB1 R clip-in markers.

## Schemes

GB2 CB●●



GB2 CD●●

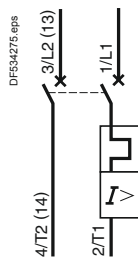

GB2 DB●●

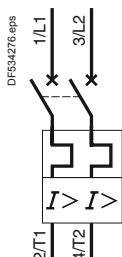

GB2 CS●●





# TeSys protection components

## Thermal-magnetic motor circuit breakers GV2, GV3 P and GV3 L

### Auxiliary contacts

TeSys GV

Type of contacts			Instantaneous auxiliary GV AN, GV AD							Fault signalling GV AD, GV AM11 <sup>(1)</sup>				Instantaneous auxiliary GV AE					
Rated insulation voltage (Ui) (associated insulation coordination)	Conforming to IEC 60947-1	V	690							690				250 (690 in relation to main circuit)					
	Conforming to CSA C22-2 n° 14 and UL 508	V	600							300				300					
Conventional thermal current (Ith)	Conforming to IEC 60947-5-1	A	6							2.5				2.5					
	Conforming to CSA C22-2 n° 14 and UL 508	A	5							1				1					
Mechanical durability (C.O.: Close - Open)		C.O.	100 000							1000				100 000					
Operational power and current conforming to IEC 60947-5-1. a.c. operation			AC-15/100 000 C.O.							AC-14/1000 C.O.				AC-15/100 000 C.O.					
	Rated operational voltage (Ue)	V	48	110	230	380	440	500	690	24	48	110	230	240	24	48	110	230	240
	Operational power, normal conditions	VA	300	500	720	850	650	500	400	36	48	72	72	48	60	120	120		
	Occasional breaking and making capacities, abnormal conditions	kVA	3	7	13	15	13	12	9	0.22	0.3	0.45	0.45	0.48	0.6	1.27	2.4		
	Rated operational current (Ie)	A	6	4.5	3.3	2.2	1.5	1	0.6	1.5	1	0.5	0.3	2	1.25	1	0.5		
Operational power and current conforming to IEC 60947-5-1. d.c. operation			DC-13/100 000 C.O.							DC-13/1000 C.O.				DC-13/100 000 C.O.					
	Rated operational voltage (Ue)	V	24	48	60	110	240	—	—	24	48	60	—	24	48	60	—		
	Operational power, normal conditions	W	140	240	180	140	120	—	—	24	15	9	—	24	15	9	—		
	Occasional breaking and making capacities, abnormal conditions	W	240	360	240	210	180	—	—	100	50	50	—	100	50	50	—		
	Rated operational current (Ie)	A	6	5	3	1.3	0.5	—	—	1	0.3	0.15	—	1	0.3	0.15	—		
Low power switching reliability of contact			GV AE: Number of failures for "n" million operating cycles (17 V-5 mA): = 10 <sup>-6</sup>																
Minimum operational conditions d.c. operation		V	17																
		mA	5																
Short-circuit protection			By GB2 CB●● circuit breaker (rating according to operational current for Ue ≤ 415 V) or by gG fuse 10 A max											GB2 CB06 or gG fuse 10 A max					
Cabling, screw clamp terminals	Number of conductors		1			2													
	Solid cable	mm <sup>2</sup>	1...2.5			1...2.5													
	Flexible cable without cable end	mm <sup>2</sup>	0.75...2.5			0.75...2.5													
	Flexible cable with cable end	mm <sup>2</sup>	0.75...1.5			0.75...1.5													
	Tightening torque	N.m	1.4 max			1.4 max													
Cabling, spring terminal connections	Flexible cable without cable end	mm <sup>2</sup>	GV AN only 0.75...2.5			0.75...2.5			—				0.75...1.5						

Operation of instantaneous auxiliary contacts

GV2

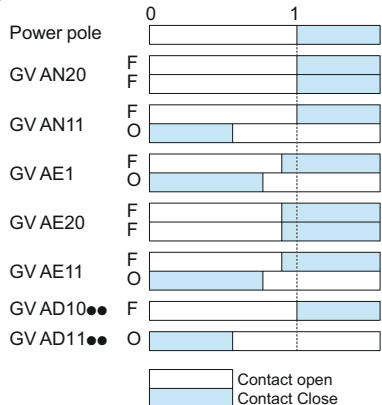

GV3P, GV3L

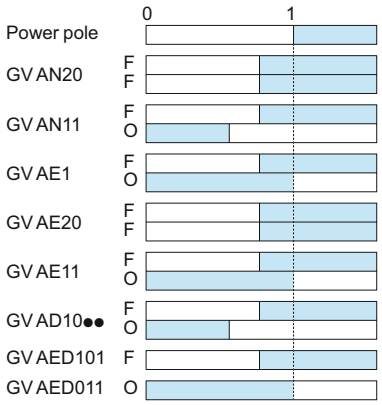

Operation of fault signalling contacts

GV AM11

Change of state following tripping on short-circuit.

GV AD10●● and GV AD01●●

Change of state following tripping on short-circuit, overload or undervoltage.

(1) For application example of fault signalling contact and short-circuit signalling contact, see page B6/82.  
 (2) Add an RC circuit type LA4 D to the load terminals, see page B8/17.

Type of contacts			Instantaneous auxiliary contacts GV3 A01...A07							Fault signalling contacts GV3 A08 and A09							
Rated insulation voltage (Ui)	Conforming to IEC 60947-1	V	690							690							
	Conforming to CSA C22-2 n° 14, UL 508	V	600 (B600)							600 (B600)							
Conventional rated thermal current (Ith)	Conforming to IEC 60947-5-1	A	6							6							
	Conforming to CSA C22-2 n° 14, UL 508	A	5 (B600)							5 (B600)							
Mechanical durability (C.O.: Close - Open)		C.O.	100 000							1000							
Operational power and current conforming to IEC 60947-5-1 a.c. operation	<b>Rated operational voltage (Ue)</b>	V	48	110	220	380	440	500	690	48	110	220	380	440	500	690	
	Operational power		AC-11/100 000 C.O.							AC-11/1000 C.O.							
		VA	350	500	800	850	700	700	400	240	460	800	850	450	450	200	
	Occasional breaking and making capacities	kVA	4	12	20	20	15	15	10	2.4	8	12	15	12	12	8	
	Operational current (Ie)	A	6	4.5	3.5	2.2	1.5	1.5	0.6	5	3.6	3.5	2.2	1	1	0.3	
Operational power and current conforming to IEC 60947-5-1 d.c. operation	<b>Rated operational voltage (Ue)</b>	V	24	48	60	110	220	24	48	60	110	220					
	Operational power		DC-11/100 000 C.O.							DC-11/1000 C.O.							
		W	180	240	180	140	120	120	120	90	70	60					
	Occasional breaking and making capacities	W	240	360	240	210	180	180	180	135	105	90					
	Operational current (Ie)	A	6	5	3	1.3	0.5	5	2.5	1.5	0.7	0.3					
Short-circuit protection			By <b>GB2 CB08</b> circuit breaker or gG fuse, 6A max														
Connection	Number of conductors		1				2										
	Solid cable	mm <sup>2</sup>	1...2.5				1...2.5										
	Flexible cable without cable end	mm <sup>2</sup>	0.75...2.5				0.75...2.5										
	Flexible cable with cable end	mm <sup>2</sup>	0.75...2.5				0.75...1.5										

GV3 A08 and A09 change state following tripping on short-circuit or overload

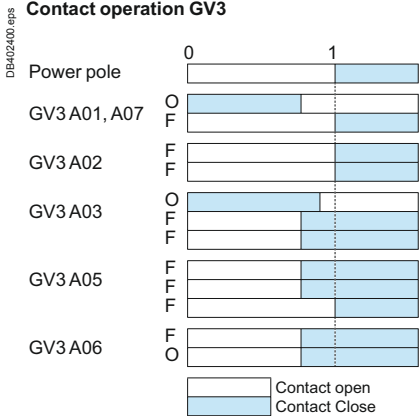

Auxiliary contact characteristics																	
Type of contacts			GV7 AE11							GV7 AB11							
Rated insulation voltage (Ui) (associated insulation coordination)	Conforming to IEC 60947-1	V	690							690							
Conventional thermal current (Ith)	Conforming to IEC 60947-5-1	A	6							6							
Mechanical durability (C.O.: Close - Open)		C.O.	50 000							50 000							
Operational current conforming to IEC 60947-5-1 a.c. operation	Rated operational voltage (Ue)	V	AC-12 or AC-15. 50 000 C.O.							AC-12 or AC-15. 50 000 C.O.							
		A	24	48	110	230/240	380/415	440	690	24	48	110	230/240	380/415	440	690	
		Rated operational current (Ie)	AC-12	A	6	6	6	6	6	6	6	5	5	5	5	5	5
		AC-15	A	6	6	5	4	3	3	0.1	5	5	4	3	2.5	2.5	0.1
Operational current conforming to IEC 60947-5-1 d.c. operation	Rated operational voltage (Ue)	V	DC-12 or DC-14. 50 000 C.O.							DC-12 or DC-14. 50 000 C.O.							
		A	24	48	110	250	24	48	110	250							
		Rated operational current (Ie)	DC-12	A	2.5	2.5	0.8	0.3	2	2	0.5	–					
		DC-14	A	1	0.2	0.5	0.03	0.5	0.1	0.25	–						
Minimum operational conditions d.c. operation		V	17							12							
		mA	5							5							
Short-circuit protection			By <b>GB2 CB●●</b> circuit breaker (rating according to operational current for Ue ≤ 415 V) or gG fuse, 10 A max.														
Cabling	Solid cable	mm <sup>2</sup>	1 x 1.5 conductor							1 x 1.5 conductor							
	Flexible cable without cable end	mm <sup>2</sup>	1 x 1.5 conductor							1 x 1.5 conductor							
	Flexible cable with cable end	mm <sup>2</sup>	1 x 1.5 conductor							1 x 1.5 conductor							

#### Characteristics of Start-Stop and fault signalling contacts

Rated insulation voltage (Ui)	Conforming to IEC 60947-1	<b>V</b>	500					
Rated operational voltage (Ue)	Conforming to IEC 60947-1	<b>V</b>	500					
Conventional thermal current (Ith)	Conforming to IEC 60947-5-1	<b>A</b>	6					
Operational power and current conforming to IEC 60947-5-1 a.c. operation (C.O.: Close - Open)			AC-15. 20 000 C.O.					
	<b>Rated operational voltage (Ue)</b>	<b>V</b>	<b>48</b>	<b>110/127</b>	<b>220/240</b>	<b>380/415</b>	<b>440</b>	<b>500</b>
	Operational power	<b>VA</b>	360	500	800	850	700	700
	Occasional breaking and making capacities	<b>VA</b>	4000	12 000	20 000	20 000	15 000	15 000
	Rated operational current (Ie)	<b>A</b>	6	4.5	3.5	2.2	1.5	1.5
Operational power and current conforming to IEC 60947-5-1 d.c. operation (C.O.: Close - Open)			DC-13. 1000 C.O.					
	<b>Rated operational voltage (Ue)</b>	<b>V</b>	<b>24</b>	<b>48</b>	<b>60</b>	<b>110</b>	<b>220</b>	
	Operational power	<b>W</b>	180	240	180	140	120	
	Occasional breaking and making capacities	<b>W</b>	240	280	240	210	180	
	Rated operational current (Ie)	<b>A</b>	6	5	3	1.3	0.5	
Short-circuit protection	Conforming to IEC 60947-5-1		By <b>GB2 CB08</b> circuit breaker or gG fuse, 6 A max					
Cabling	Solid cable	<b>mm<sup>2</sup></b>	1 x 1...4 conductor					
	Flexible cable without cable end	<b>mm<sup>2</sup></b>	1 x 2.5 conductor					
	Flexible cable with cable end	<b>mm<sup>2</sup></b>	1 x 1...2.5 conductor or 2 x 1...2.5 conductors					
Tightening torque		<b>N.m</b>	0.8					

Characteristics of electric trips									
Circuit breaker type			GV2 ME, GV2 P GV3 P, GV3 L		GV2 ME only	GV3 ME80		GV7 R	
Type of trip			GV AU	GV AS	GV AX <sup>(1)</sup>	GV3 B	GV3 D	GV7 AU	GV7 AS
Rated insulation voltage (Ui)	Conforming to IEC 60947-1	<b>V</b>	690	690	500	690	690	690	690
	Conforming to CSA C22-2 n° 14, UL 508	<b>V</b>	600	600	–	600 (B600)	600 (B600)	600	600
Operational voltage	Conforming to IEC 60947-1	<b>V</b>	0.85... 1.1 Un	0.7... 1.1 Un	0.85... 1.1 Un	0.8...1.1 Un		0.85... 1.1 Un	0.7... 1.1 Un
Drop-out voltage		<b>V</b>	0.7... 0.35 Un	0.75... 0.2 Un	0.7... 0.35 Un	0.7...0.35 Un		0.35... 0.7 Ue	0.2... 0.75 Ue
Inrush consumption	~	<b>VA</b>	12	14	12	12		< 10	
Sealed consumption	~	<b>VA</b>	3.5	5	3.5	7		< 5	
Operating time	Conforming to IEC 60947-1		From the moment the voltage reaches its operational value until opening of the circuit-breaker.						
		<b>ms</b>	10...15			10	15	< 50	
On-load factor			100 %			100 %		100 %	
Cabling	Number of conductors		2 or 4			1 or 2		1	
	Solid cable	<b>mm<sup>2</sup></b>	1...2.5			1...2.5		1.5	
	Flexible cable without cable end	<b>mm<sup>2</sup></b>	0.75...2.5			0.75...2.5		1.5	
	Flexible cable with cable end	<b>mm<sup>2</sup></b>	0.75...1.5			0.75...2.5		1	
Tightening torque		<b>N.m</b>	1.4 max			1.2		1.2	
Mechanical durability (C.O.: Close - Open)		<b>C.O.</b>	30 000 (GV2 ME and GV2 P) 10 000 (GV3 P and GV3 L)			50 % of the mechanical durability of the circuit-breaker			

<sup>(1)</sup> Wiring scheme of undervoltage trip for dangerous machines (conforming to INRS) on **GV2 ME** only, see page B6/82.

# TeSys protection components

## Thermal-magnetic and magnetic motor circuit breakers GV2 and GV3

### Accessories

#### Characteristics of 3-pole busbars GV2 G●●● and GV3 G●64

			GV2 G●●●	GV3 G●64
Rated insulation voltage (Ui)	Conforming to IEC 60947-1	<b>V</b>	690	690
Conventional thermal current (Ith)	Conforming to IEC 60439-1	<b>A</b>	63	115
Permissible peak current (I peak)		<b>kA</b>	11	20
Permissible thermal limit (I²t)		<b>kA²s</b>	104	300
Degree of protection	Conforming to IEC 60529		IP 20	IP 20
Terminal block			Yes	–

#### Characteristics of terminal blocks GV2 G05 and GV1 G09 (for GV2 ME and GV2 P)

Rated insulation voltage (Ui)	Conforming to IEC 60947-1	<b>V</b>	690
Conventional thermal current (Ith)	Conforming to IEC 60439-1	<b>A</b>	63
Degree of protection	Conforming to IEC 60529		IP 20
Connection	Solid cable	<b>mm²</b>	1 x 1.5 to 25 conductor or 2 x 1.5 to 6 conductors
	Flexible cable without cable end	<b>mm²</b>	1 x 1.5 to 16 conductor or 2 x 2.5 to 4 conductors
	Flexible cable with cable end	<b>mm²</b>	1 x 1.5 to 10 conductor or 2 x 1.5 to 2 conductors
	Flexible or solid cable AWG		1 AWG 4
Tightening torque	Connector	<b>N.m</b>	2.2
	Screw clamp terminals	<b>N.m</b>	1.7

#### Characteristics of current limiters (GV2 ME and GV2 P)

Type			GV1 L3	LA9 LB920		
Rated insulation voltage (Ui)	Conforming to IEC 60947-1	<b>V</b>	690	690		
Conventional thermal current (Ith)	Conforming to IEC 60947-1	<b>A</b>	63	63		
Rated operational current (Ie)		<b>A</b>	32	32		
Operating threshold	rms current	<b>A</b>	1500 (non adjustable threshold)		1000 (non adjustable threshold)	
Connection			<b>1 conductor</b>	<b>2 conductors</b>	<b>1 conductor</b>	<b>2 conductors</b>
	Solid cable	<b>mm²</b>	1.5...25	1.5...10	1.5...25	1.5...10
	Flexible cable without cable end	<b>mm²</b>	1.5...25	2.5...10	1.5...25	1.5...10
	Flexible cable with cable end	<b>mm²</b>	1.5...16	1.5...4	1.5...16	1.5...4
Tightening torque		<b>N.m</b>	2.2			