

K80DT003L Datasheet

Technical Specifications

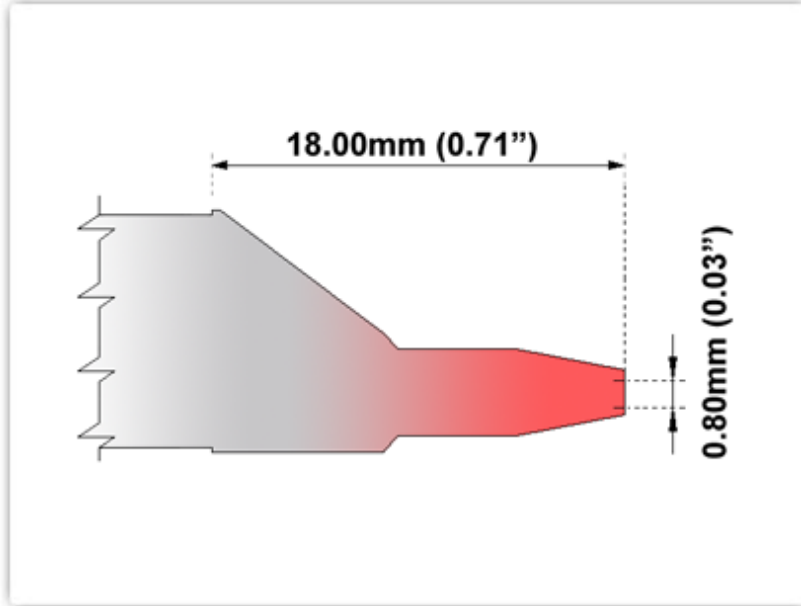

K80DT003L

Desoldering Tip - Inner Diameter 0.80mm (0.03"), Long Reach

Tip Style: Desoldering
 Tip Width: 0.80mm (0.03")
 Tip Length: 18.00mm (0.71")

800 Type Cartridge ¹ :	420°C - 475°C
RoHS Compliant ² / Lead Free:	YES
For Use With:	TMT-2000PS, TMT-2000S-K, TMT-2000S-KM, TMT-2000S-P, TMT-2000S-PM, TMT-2000S-SM, TMT-2000S-DT, TMT-2000S-TZ

Material Composition

Patented Color Band



All components are RoHS compliant and Lead-Free.

¹ Thermaltronics tip cartridges will typically idle within a temperature range of +/-1.1°C. However, there is variation in idle temperature across tip geometries within an individual temperature series. Thermaltronics offers a wide variety of tip geometries from 0.25mm fine point tip to 5mm chisel. The length and geometry of a tip will have an influence on the tip idle temperature. To accurately measure idle temperature it will depend greatly on the measurement method, technique and equipment used. Two different methods or the use of alternative equipment will produce different test results.

² Please refer to <http://www.rohs.gov.uk> for details on RoHS Compliance.