



Specific Lighting

2835 Product Data Sheet

AZlxx series

Create Date :

Revision:

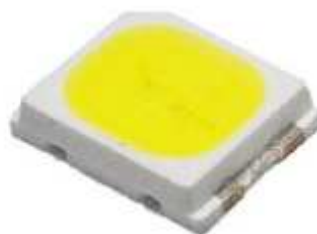

**Specific Lighting
LTW-2835AZIXX**

1. Description

The LiteON 2835 Product series is a wide beam angle standard-dimension package, combining the lifetime and reliability advantages of Light Emitting Diodes with the brightness of conventional lighting. It gives you total design freedom and unmatched brightness, creating a new opportunities for solid state lighting to displace conventional lighting technologies.

1.1 Features

- Package in 8mm tape on 7" diameter reels.
- Compatible with automatic placement equipment.
- Compatible with infrared and vapor phase reflow solder process.
- EIA STD package.
- I.C. compatible.
- Meet green product and Pb-free(According to RoHS)

1.2 Available Part Numbers

CCT	Part No.
2700K	LTW-2835AZI27
3000K	LTW-2835AZI30
3500K	LTW-2835AZI35
4000K	LTW-2835AZI40
5000K	LTW-2835AZI50
5700K	LTW-2835AZI57
6500K	LTW-2835AZI65

Specific Lighting
LTW-2835AZIXX

2. Outline Dimensions

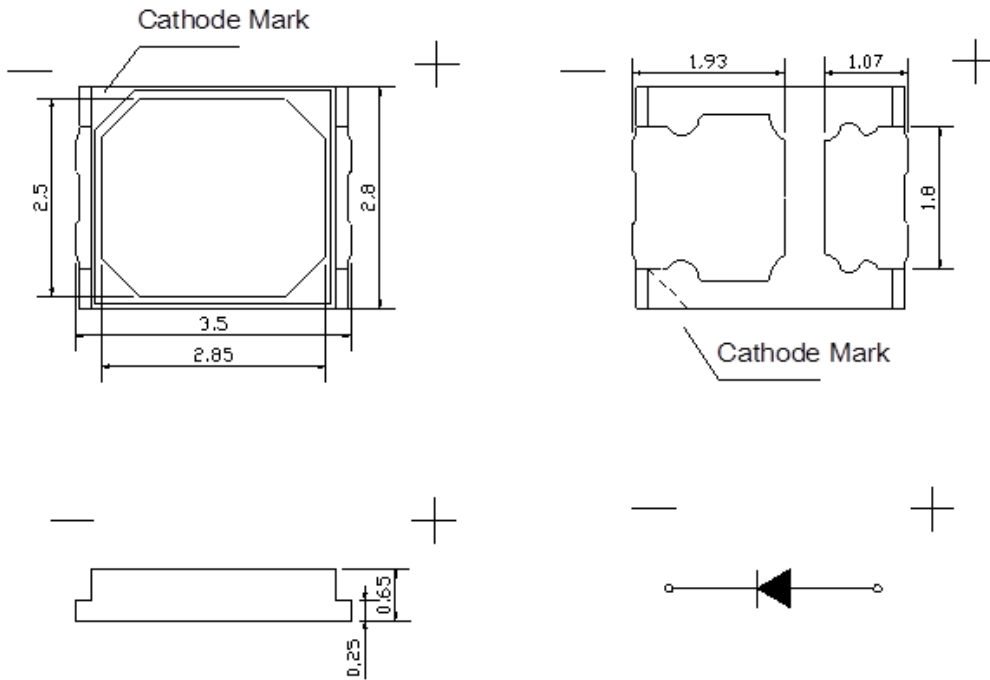

Part No.	Lens Color	Source Color
LTW-2835AZI27	Orange	InGaN Blue
LTW-2835AZI30		
LTW-2835AZI35		
LTW-2835AZI40		
LTW-2835AZI50		
LTW-2835AZI57		
LTW-2835AZI65		

Notes:

1. All dimensions are in millimeters.
2. Thickness tolerance of copper plate is ± 0.02 mm.
3. Thickness tolerance of product is ± 0.05 mm.
4. Tolerance is ± 0.1 mm unless otherwise noted.

**Specific Lighting
LTW-2835AZIXX**

3. Absolute Maximum Ratings at Ta=25°C

Parameter	Symbol	Rating	Unit
Power Dissipation	P _o	656	mW
Continuous Forward Current	I _F	200	mA
Pulse Forward Current	I _{PF}	350	mA
Reverse Current @ -5V	I _R	10	μA
Operating Temperature Range	T _{opr}	-40 ~ +85	°C
Storage Temperature Range	T _{stg}	-40 ~ +100	°C
Junction Temperature	T _j	115	°C

Note:

1. Pulsed Duty $\leq 1/10$, Pulse width $\leq 100\mu s$.
2. Forbid to operating at reverse voltage condition for long
3. It is recommended to follow de-rating curve to use maximum rating to ensure LED can operated normally.

Specific Lighting LTW-2835AZIXX

4. Electro-Optical Characteristics at Ta=25°C

4.1 Typical Performance

Parameter	Symbol	Values								Unit	Test Condition
		Typ.	2700	3000	3500	4000	5000	5700	6500		
Correlated Color Temp.	CCT	Typ.	2700	3000	3500	4000	5000	5700	6500	K	
Chromaticity Coordinates	x	Typ.	0.458	0.434	0.408	0.382	0.345	0.329	0.312	-	I _F = 65mA
	y	Typ.	0.410	0.403	0.392	0.380	0.355	0.342	0.328		
Luminous Flux ¹	Φ _v	Min	30	30.5	31	32	33	32.5	32	lm	
		Typ.	31	31.5	32	33	34	33.5	33		
		Max.	34	34.5	35	36	37	36.5	36		
Color Rendering Index	CRI	Min.	80						-		
Viewing Angle	2θ _{1/2}	Typ.	120						deg		
Forward Voltage	V _F	Min	2.65						V		
		Typ.	2.75								
		Max.	3.05								
Thermal Resistance	R _{jt}	Typ.	8						°C/W		
ESD-Withstand Voltage	ESD	Min	2k						HBM	V	

Notes

- Luminous flux is the total luminous flux output as measured with an integrating sphere.
- Iv classification code is marked on each packing bag.
- The chromaticity coordinates (x, y) is derived from the 1931 CIE chromaticity diagram.
- Caution in ESD:
 - Static Electricity and surge damages the LED. It is recommended using a wrist band or anti-electrostatic glove when handling the LED. All devices, equipment and machinery must be properly grounded.
- CAS140B is the test standard for the chromaticity coordinates (x, y) & Iv
- The chromaticity coordinates (x, y) guarantee should be added ± 0.007 tolerance
- Ra measurement allowance is ±3
- Luminous flux measurement tolerance is ±10%
- Forward Voltage measurement tolerance is ±0.1V

Specific Lighting LTW-2835AZIXX

4.2 Forward Current vs. Lumen

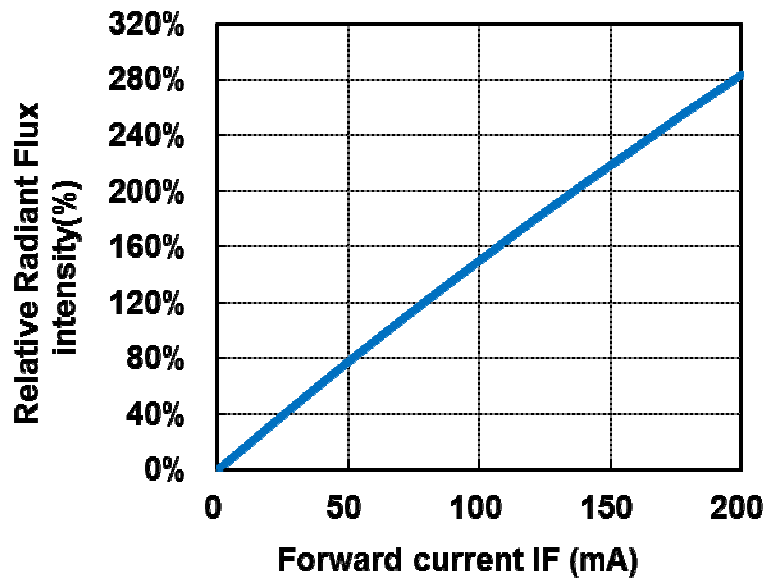

Current (mA)	VF (V)	Lumen (lm)						
		2700K	3000K	3500K	4000K	5000K	5700K	6500K
20	2.64	9.9	10.0	10.2	10.5	10.8	10.7	10.5
40	2.71	19.5	19.9	20.2	20.8	21.4	21.1	20.8
60	2.76	28.9	29.4	29.9	30.8	31.7	31.3	30.8
65	2.77	31.2	31.7	32.2	33.2	34.2	33.7	33.2
80	2.81	38.0	38.6	39.3	40.5	41.7	41.1	40.5
100	2.86	46.9	47.6	48.4	49.9	51.4	50.7	49.9
120	2.90	55.6	56.5	57.4	59.2	61.0	60.1	59.2
140	2.94	64.1	65.1	66.1	68.2	70.3	69.2	68.2
160	2.98	72.3	73.4	74.6	76.9	79.3	78.1	76.9
180	3.03	80.5	81.8	83.1	85.7	88.3	87.0	85.7
200	3.07	88.4	89.8	91.3	94.1	97.0	95.5	94.1

**Specific Lighting
LTW-2835AZIXX**

4.3 Relative Spectral Power Distribution at Typical Current

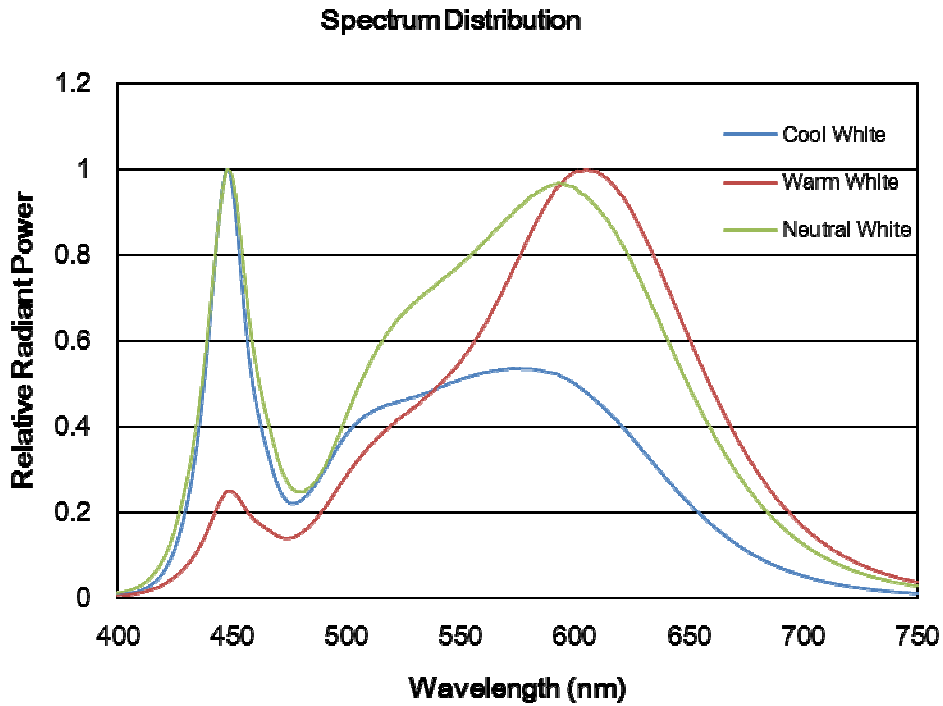

4.4 Radiation Characteristics

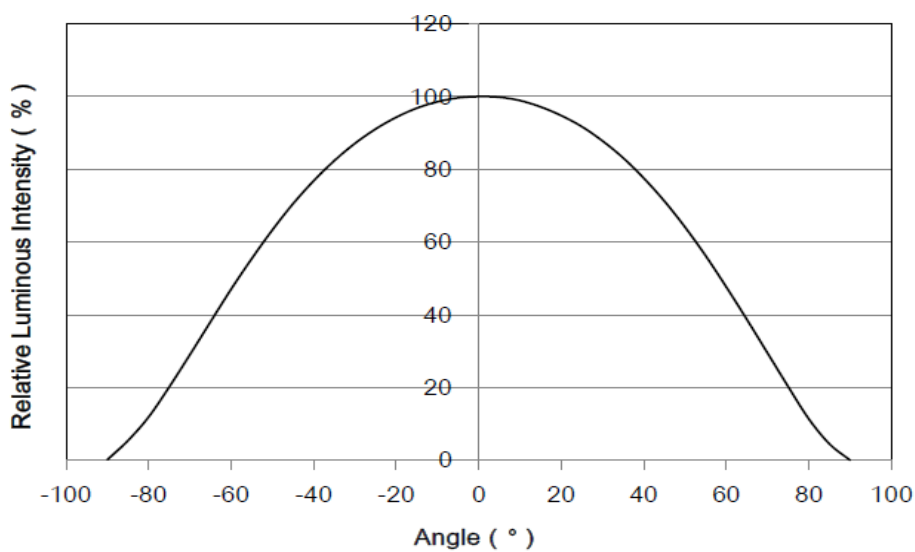

**Specific Lighting
LTW-2835AZIXX**

4.5 Forward Current vs. Forward Voltage

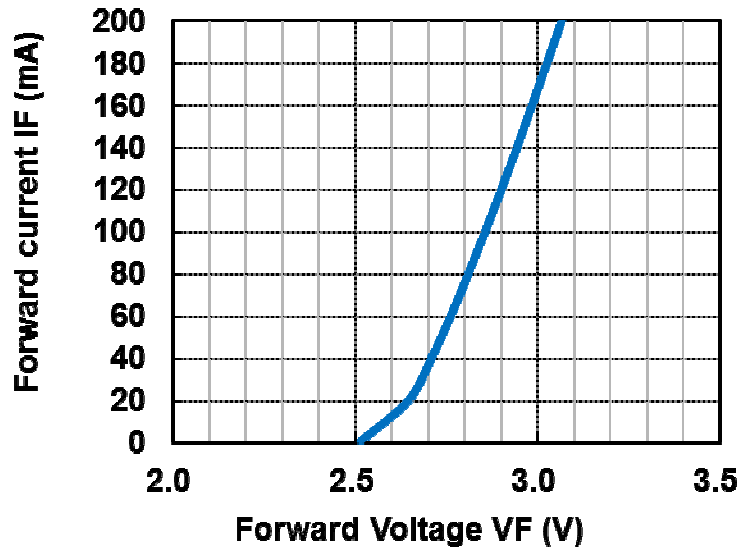

4.6 Relative Intensity vs. Board Temperature

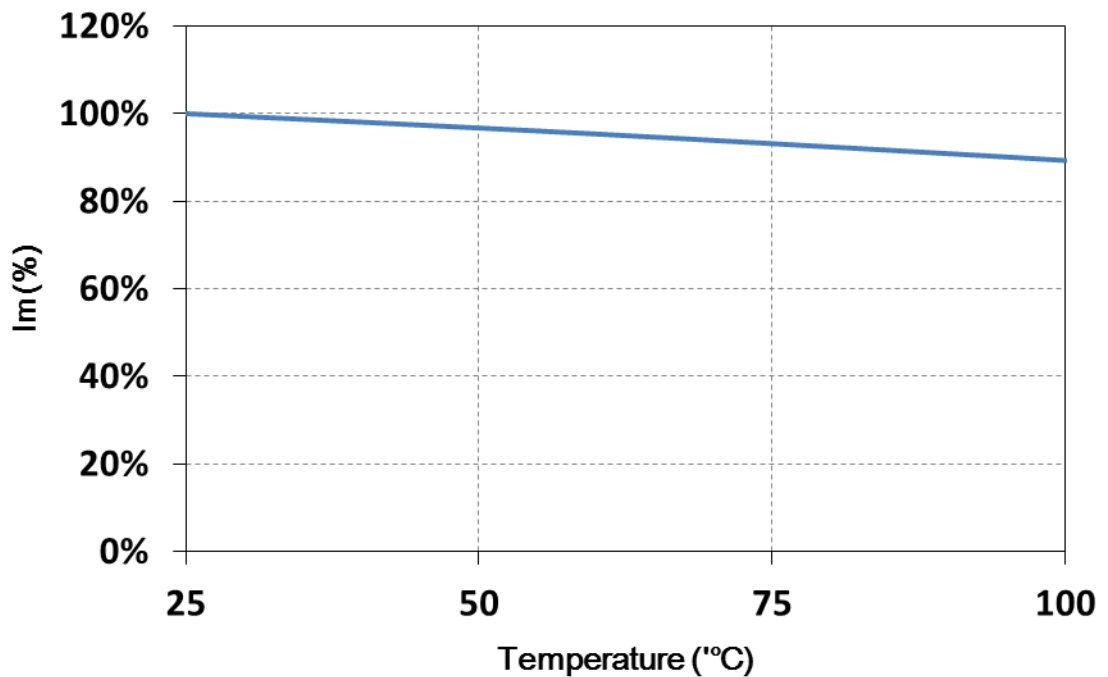

Specific Lighting
LTW-2835AZIXX

4.7 Voltage vs. Board Temperature

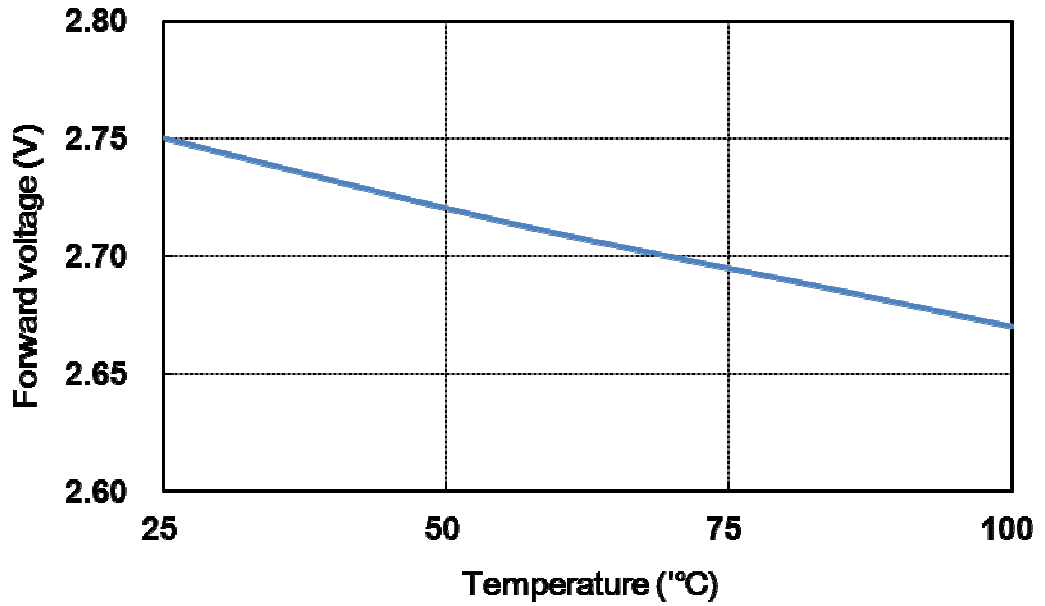

Specific Lighting LTW-2835AZIXX

5. Binning Definition

5.1 Color Bin

2700K															
Rank	-	x	y	Rank	-	x	y	Rank	-	x	y	Rank	-	x	y
D11	1	0.4562	0.4260	D21	1	0.4625	0.4275	D31	1	0.4688	0.4290	D41	1	0.4750	0.4304
	2	0.4515	0.4168		2	0.4576	0.4183		2	0.4636	0.4197		2	0.4697	0.4211
	3	0.4576	0.4183		3	0.4636	0.4197		3	0.4697	0.4211		3	0.4758	0.4225
	4	0.4625	0.4275		4	0.4688	0.4290		4	0.4750	0.4304		4	0.4813	0.4319
D12	1	0.4562	0.4260	D22	1	0.4625	0.4275	D32	1	0.4688	0.4290	D42	1	0.4750	0.4304
	2	0.4515	0.4168		2	0.4576	0.4183		2	0.4636	0.4197		2	0.4697	0.4211
	3	0.4526	0.4090		3	0.4585	0.4104		3	0.4644	0.4118		3	0.4703	0.4132
	4	0.4576	0.4183		4	0.4636	0.4197		4	0.4697	0.4211		4	0.4758	0.4225
D13	1	0.4515	0.4168	D23	1	0.4576	0.4183	D33	1	0.4636	0.4197	D43	1	0.4697	0.4211
	2	0.4468	0.4077		2	0.4526	0.4090		2	0.4585	0.4104		2	0.4644	0.4118
	3	0.4420	0.3985		3	0.4477	0.3998		3	0.4534	0.4011		3	0.4591	0.4025
	4	0.4477	0.3998		4	0.4534	0.4011		4	0.4591	0.4025		4	0.4648	0.4038
D14	1	0.4526	0.4090	D24	1	0.4585	0.4104	D34	1	0.4644	0.4118	D44	1	0.4703	0.4132
	2	0.4468	0.4077		2	0.4526	0.4090		2	0.4585	0.4104		2	0.4644	0.4118
	3	0.4420	0.3985		3	0.4477	0.3998		3	0.4534	0.4011		3	0.4591	0.4025
	4	0.4477	0.3998		4	0.4428	0.3906		4	0.4483	0.3919		4	0.4538	0.3931
	1	0.4420	0.3985		1	0.4477	0.3998		1	0.4534	0.4011		1	0.4591	0.4025
	2	0.4373	0.3893		2	0.4428	0.3906		2	0.4483	0.3919		2	0.4538	0.3931
	3	0.4428	0.3906		3	0.4483	0.3919		3	0.4538	0.3931		3	0.4593	0.3944
	4	0.4477	0.3998		4	0.4534	0.4011		4	0.4591	0.4025		4	0.4648	0.4038
	1	0.4420	0.3985		1	0.4477	0.3998		1	0.4534	0.4011		1	0.4591	0.4025

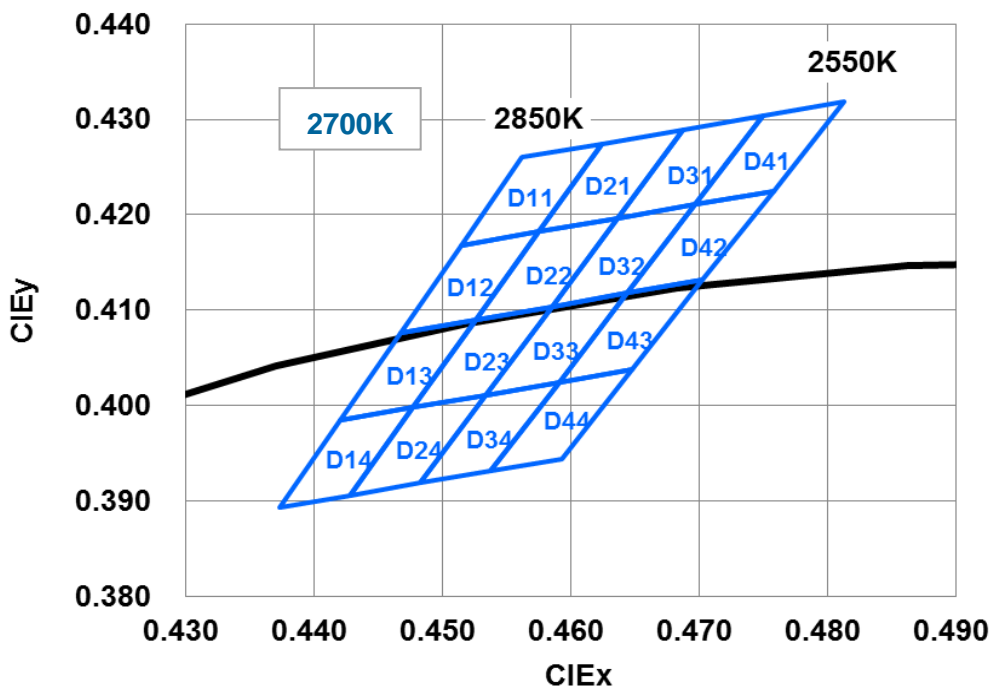

Specific Lighting
LTW-2835AZIXX

3000K															
Rank	-	x	y	Rank	-	x	y	Rank	-	x	y	Rank	-	x	y
E11	1	0.4299	0.4165	E21	1	0.4365	0.4189	E31	1	0.4431	0.4213	E41	1	0.4496	0.4236
	2	0.4261	0.4077		2	0.4324	0.4100		2	0.4388	0.4123		2	0.4451	0.4146
	3	0.4324	0.4100		3	0.4388	0.4123		3	0.4451	0.4146		3	0.4515	0.4168
	4	0.4365	0.4189		4	0.4431	0.4213		4	0.4496	0.4236				
E12	1	0.4299	0.4165	E22	1	0.4365	0.4189	E32	1	0.4431	0.4213	E42	1	0.4496	0.4236
	2	0.4261	0.4077		2	0.4324	0.4100		2	0.4388	0.4123		2	0.4451	0.4146
	3	0.4223	0.3990		3	0.4284	0.4011		3	0.4345	0.4033		3	0.4406	0.4055
	4	0.4284	0.4011		4	0.4345	0.4033		4	0.4406	0.4055				
E13	1	0.4261	0.4077	E23	1	0.4324	0.4100	E33	1	0.4388	0.4123	E43	1	0.4451	0.4146
	2	0.4223	0.3990		2	0.4284	0.4011		2	0.4345	0.4033		2	0.4406	0.4055
	3	0.4185	0.3902		3	0.4244	0.3923		3	0.4303	0.3943		3	0.4361	0.3964
	4	0.4244	0.3923		4	0.4303	0.3943		4	0.4361	0.3964				
E14	1	0.4223	0.3990	E24	1	0.4284	0.4011	E34	1	0.4345	0.4033	E44	1	0.4406	0.4055
	2	0.4185	0.3902		2	0.4244	0.3923		2	0.4303	0.3943		2	0.4361	0.3964
	3	0.4244	0.3923		3	0.4303	0.3943		3	0.4361	0.3964		3	0.4420	0.3985
	4	0.4284	0.4011		4	0.4345	0.4033		4	0.4406	0.4055				
E11	1	0.4223	0.3990	E21	1	0.4284	0.4011	E31	1	0.4345	0.4033	E41	1	0.4406	0.4055
	2	0.4185	0.3902		2	0.4244	0.3923		2	0.4303	0.3943		2	0.4361	0.3964
	3	0.4244	0.3923		3	0.4303	0.3943		3	0.4361	0.3964		3	0.4420	0.3985
	4	0.4284	0.4011		4	0.4345	0.4033		4	0.4406	0.4055				
E12	1	0.4223	0.3990	E22	1	0.4284	0.4011	E32	1	0.4345	0.4033	E42	1	0.4406	0.4055
	2	0.4185	0.3902		2	0.4244	0.3923		2	0.4303	0.3943		2	0.4361	0.3964
	3	0.4244	0.3923		3	0.4303	0.3943		3	0.4361	0.3964		3	0.4420	0.3985
	4	0.4284	0.4011		4	0.4345	0.4033		4	0.4406	0.4055				
E13	1	0.4223	0.3990	E23	1	0.4284	0.4011	E33	1	0.4345	0.4033	E43	1	0.4406	0.4055
	2	0.4185	0.3902		2	0.4244	0.3923		2	0.4303	0.3943		2	0.4361	0.3964
	3	0.4244	0.3923		3	0.4303	0.3943		3	0.4361	0.3964		3	0.4420	0.3985
	4	0.4284	0.4011		4	0.4345	0.4033		4	0.4406	0.4055				
E14	1	0.4223	0.3990	E24	1	0.4284	0.4011	E34	1	0.4345	0.4033	E44	1	0.4406	0.4055
	2	0.4185	0.3902		2	0.4244	0.3923		2	0.4303	0.3943		2	0.4361	0.3964
	3	0.4244	0.3923		3	0.4303	0.3943		3	0.4361	0.3964		3	0.4420	0.3985
	4	0.4284	0.4011		4	0.4345	0.4033		4	0.4406	0.4055				

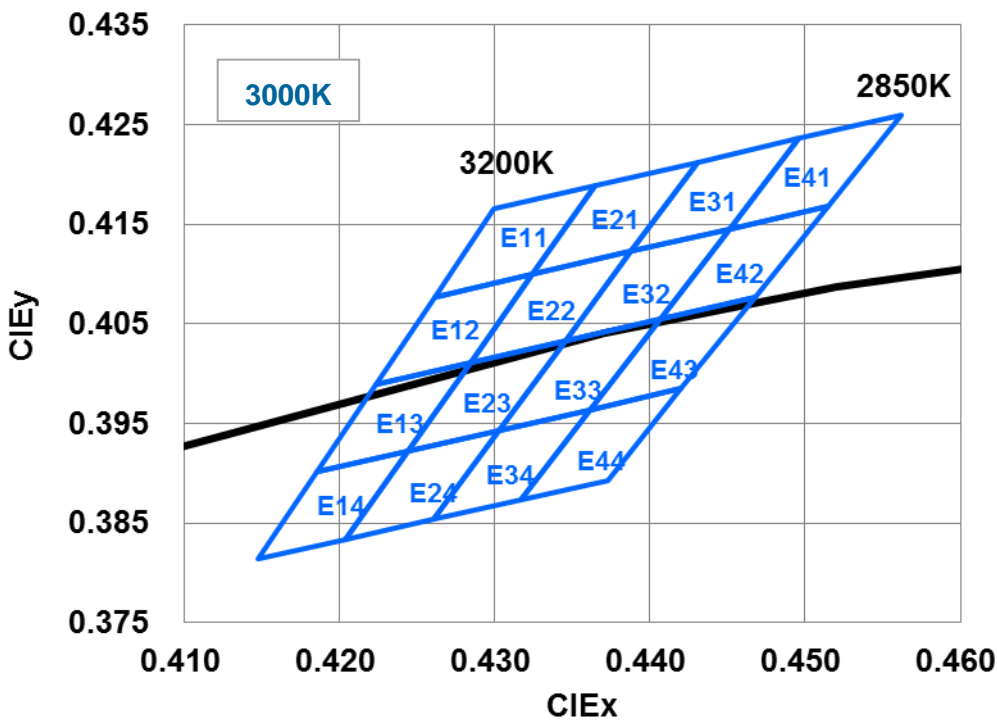

Specific Lighting
LTW-2835AZIXX

3500K															
Rank	-	x	y	Rank	-	x	y	Rank	-	x	y	Rank	-	x	y
F11	1	0.3996	0.4015	F21	1	0.4072	0.4053	F31	1	0.4148	0.4090	F41	1	0.4223	0.4128
	2	0.3969	0.3934		2	0.4042	0.3970		2	0.4115	0.4006		2	0.4188	0.4041
	3	0.4042	0.3970		3	0.4115	0.4006		3	0.4188	0.4041		3	0.4261	0.4077
	4	0.4072	0.4053		4	0.4148	0.4090		4	0.4223	0.4128		4	0.4299	0.4165
F12	1	0.3996	0.4015	F22	1	0.4072	0.4053	F32	1	0.4148	0.4090	F42	1	0.4223	0.4128
	1	0.3969	0.3934		1	0.4042	0.3970		1	0.4115	0.4006		1	0.4188	0.4041
	2	0.3943	0.3853		2	0.4013	0.3887		2	0.4083	0.3921		2	0.4153	0.3955
	3	0.4013	0.3887		3	0.4083	0.3921		3	0.4153	0.3955		3	0.4223	0.3990
F13	4	0.4042	0.3970	F23	4	0.4115	0.4006	F33	4	0.4188	0.4041	F43	4	0.4261	0.4077
	1	0.3969	0.3934		1	0.4042	0.3970		1	0.4115	0.4006		1	0.4188	0.4041
	2	0.3943	0.3853		2	0.4013	0.3887		2	0.4083	0.3921		2	0.4153	0.3955
	3	0.3916	0.3771		3	0.3983	0.3804		3	0.4050	0.3837		3	0.4118	0.3869
F14	4	0.4013	0.3887	F24	4	0.4083	0.3921	F34	4	0.4153	0.3955	F44	4	0.4223	0.3990
	1	0.3943	0.3853		1	0.4013	0.3887		1	0.4083	0.3921		1	0.4153	0.3955
	2	0.3916	0.3771		2	0.3983	0.3804		2	0.4050	0.3837		2	0.4118	0.3869
	3	0.3983	0.3804		3	0.4050	0.3837		3	0.4118	0.3869		3	0.4185	0.3902
F11	4	0.4013	0.3887	F21	4	0.4083	0.3921	F31	4	0.4153	0.3955	F41	4	0.4223	0.3990
	1	0.3943	0.3853		1	0.4013	0.3887		1	0.4083	0.3921		1	0.4153	0.3955
	2	0.3916	0.3771		2	0.3983	0.3804		2	0.4050	0.3837		2	0.4118	0.3869
	3	0.3983	0.3804		3	0.4050	0.3837		3	0.4118	0.3869		3	0.4185	0.3902
F12	4	0.4013	0.3887	F22	4	0.4083	0.3921	F32	4	0.4153	0.3955	F42	4	0.4223	0.3990
	1	0.3943	0.3853		1	0.4013	0.3887		1	0.4083	0.3921		1	0.4153	0.3955
	2	0.3916	0.3771		2	0.3983	0.3804		2	0.4050	0.3837		2	0.4118	0.3869
	3	0.3983	0.3804		3	0.4050	0.3837		3	0.4118	0.3869		3	0.4185	0.3902
F13	4	0.4013	0.3887	F23	4	0.4083	0.3921	F33	4	0.4153	0.3955	F43	4	0.4223	0.3990
	1	0.3943	0.3853		1	0.4013	0.3887		1	0.4083	0.3921		1	0.4153	0.3955
	2	0.3916	0.3771		2	0.3983	0.3804		2	0.4050	0.3837		2	0.4118	0.3869
	3	0.3983	0.3804		3	0.4050	0.3837		3	0.4118	0.3869		3	0.4185	0.3902
F14	4	0.4013	0.3887	F24	4	0.4083	0.3921	F34	4	0.4153	0.3955	F44	4	0.4223	0.3990
	1	0.3943	0.3853		1	0.4013	0.3887		1	0.4083	0.3921		1	0.4153	0.3955
	2	0.3916	0.3771		2	0.3983	0.3804		2	0.4050	0.3837		2	0.4118	0.3869
	3	0.3983	0.3804		3	0.4050	0.3837		3	0.4118	0.3869		3	0.4185	0.3902
F11	4	0.4013	0.3887	F21	4	0.4083	0.3921	F31	4	0.4153	0.3955	F41	4	0.4223	0.3990
	1	0.3943	0.3853		1	0.4013	0.3887		1	0.4083	0.3921		1	0.4153	0.3955
	2	0.3916	0.3771		2	0.3983	0.3804		2	0.4050	0.3837		2	0.4118	0.3869
	3	0.3983	0.3804		3	0.4050	0.3837		3	0.4118	0.3869		3	0.4185	0.3902
F12	4	0.4013	0.3887	F22	4	0.4083	0.3921	F32	4	0.4153	0.3955	F42	4	0.4223	0.3990
	1	0.3943	0.3853		1	0.4013	0.3887		1	0.4083	0.3921		1	0.4153	0.3955
	2	0.3916	0.3771		2	0.3983	0.3804		2	0.4050	0.3837		2	0.4118	0.3869
	3	0.3983	0.3804		3	0.4050	0.3837		3	0.4118	0.3869		3	0.4185	0.3902
F13	4	0.4013	0.3887	F23	4	0.4083	0.3921	F33	4	0.4153	0.3955	F43	4	0.4223	0.3990
	1	0.3943	0.3853		1	0.4013	0.3887		1	0.4083	0.3921		1	0.4153	0.3955
	2	0.3916	0.3771		2	0.3983	0.3804		2	0.4050	0.3837		2	0.4118	0.3869
	3	0.3983	0.3804		3	0.4050	0.3837		3	0.4118	0.3869		3	0.4185	0.3902
F14	4	0.4013	0.3887	F24	4	0.4083	0.3921	F34	4	0.4153	0.3955	F44	4	0.4223	0.3990
	1	0.3943	0.3853		1	0.4013	0.3887		1	0.4083	0.3921		1	0.4153	0.3955
	2	0.3916	0.3771		2	0.3983	0.3804		2	0.4050	0.3837		2	0.4118	0.3869
	3	0.3983	0.3804		3	0.4050	0.3837		3	0.4118	0.3869		3	0.4185	0.3902

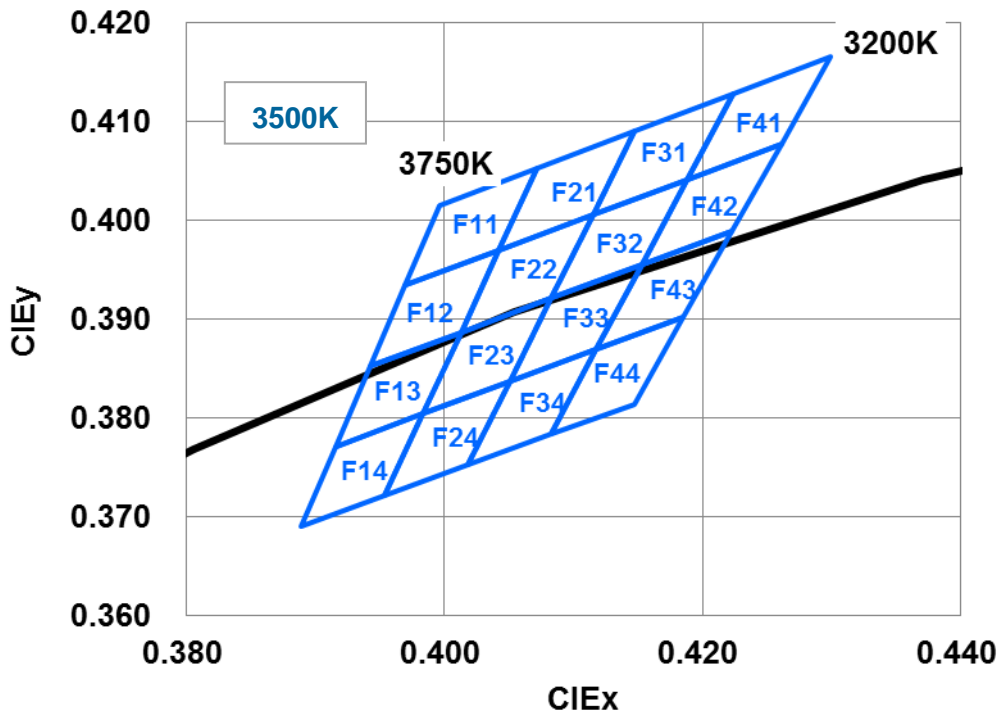

Specific Lighting LTW-2835AZIXX

4000K															
Rank	-	x	y	Rank	-	x	y	Rank	-	x	y	Rank	-	x	y
G11	1	0.3736	0.3874	G21	1	0.3804	0.3917	G31	1	0.3871	0.3959	G41	1	0.3939	0.4002
	2	0.3720	0.3800		2	0.3784	0.3841		2	0.3849	0.3881		2	0.3914	0.3922
	3	0.3784	0.3841		3	0.3849	0.3881		3	0.3914	0.3922		3	0.3979	0.3962
	4	0.3804	0.3917		4	0.3871	0.3959		4	0.3939	0.4002		4	0.4006	0.4044
G12	1	0.3736	0.3874	G22	1	0.3804	0.3917	G32	1	0.3871	0.3959	G42	1	0.3939	0.4002
	2	0.3720	0.3800		2	0.3784	0.3841		2	0.3849	0.3881		2	0.3914	0.3922
	3	0.3703	0.3726		3	0.3765	0.3765		3	0.3828	0.3803		3	0.3890	0.3842
	4	0.3765	0.3765		4	0.3828	0.3803		4	0.3890	0.3842		4	0.3952	0.3880
G13	1	0.3784	0.3841	G23	1	0.3849	0.3881	G33	1	0.3914	0.3922	G43	1	0.3979	0.3962
	2	0.3720	0.3800		2	0.3784	0.3841		2	0.3849	0.3881		2	0.3914	0.3922
	3	0.3703	0.3726		3	0.3765	0.3765		3	0.3828	0.3803		3	0.3890	0.3842
	4	0.3765	0.3765		4	0.3828	0.3803		4	0.3890	0.3842		4	0.3952	0.3880
G14	1	0.3687	0.3652	G24	1	0.3746	0.3689	G34	1	0.3806	0.3725	G44	1	0.3865	0.3762
	2	0.3670	0.3578		2	0.3727	0.3613		2	0.3784	0.3647		2	0.3841	0.3682
	3	0.3727	0.3613		3	0.3784	0.3647		3	0.3841	0.3682		3	0.3898	0.3716
	4	0.3746	0.3689		4	0.3806	0.3725		4	0.3865	0.3762		4	0.3925	0.3798
	1	0.3687	0.3652		1	0.3746	0.3689		1	0.3806	0.3725		1	0.3865	0.3762

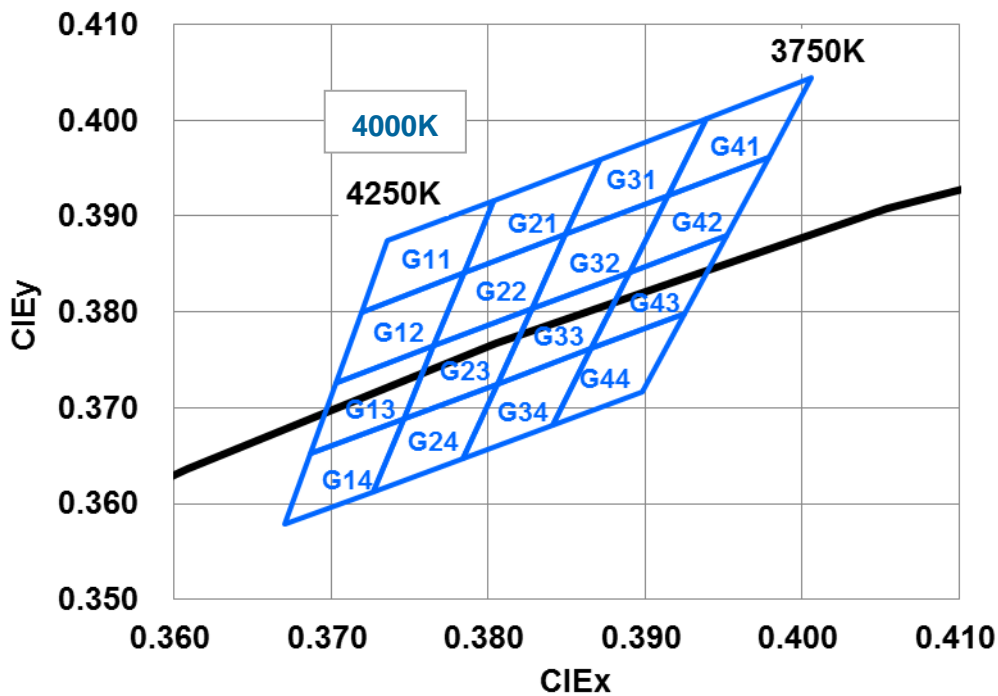

Specific Lighting LTW-2835AZIXX

5000K															
Rank	-	x	y	Rank	-	x	y	Rank	-	x	y	Rank	-	x	y
H11	1	0.3376	0.3616	H21	1	0.3420	0.3652	H31	1	0.3464	0.3688	H41	1	0.3507	0.3724
	2	0.3374	0.3554		2	0.3416	0.3589		2	0.3458	0.3623		2	0.3500	0.3657
	3	0.3416	0.3589		3	0.3458	0.3623		3	0.3500	0.3657		3	0.3542	0.3692
	4	0.3420	0.3652		4	0.3464	0.3688		4	0.3507	0.3724		4	0.3551	0.3760
H12	1	0.3376	0.3616	H22	1	0.3420	0.3652	H32	1	0.3464	0.3688	H42	1	0.3507	0.3724
	2	0.3374	0.3554		2	0.3416	0.3589		2	0.3458	0.3623		2	0.3500	0.3657
	3	0.3416	0.3589		3	0.3458	0.3623		3	0.3500	0.3657		3	0.3542	0.3692
	4	0.3420	0.3652		4	0.3464	0.3688		4	0.3507	0.3724		4	0.3551	0.3760
H13	1	0.3374	0.3554	H23	1	0.3416	0.3589	H33	1	0.3458	0.3623	H43	1	0.3500	0.3657
	2	0.3371	0.3493		2	0.3412	0.3525		2	0.3452	0.3558		2	0.3493	0.3591
	3	0.3412	0.3525		3	0.3452	0.3558		3	0.3493	0.3591		3	0.3533	0.3624
	4	0.3416	0.3589		4	0.3458	0.3623		4	0.3500	0.3657		4	0.3542	0.3692
H14	1	0.3374	0.3554	H24	1	0.3416	0.3589	H34	1	0.3458	0.3623	H44	1	0.3500	0.3657
	2	0.3369	0.3431		2	0.3407	0.3462		2	0.3446	0.3493		2	0.3485	0.3524
	3	0.3407	0.3462		3	0.3446	0.3493		3	0.3485	0.3524		3	0.3524	0.3555
	4	0.3412	0.3525		4	0.3452	0.3558		4	0.3493	0.3591		4	0.3533	0.3624
H14	1	0.3371	0.3493	H24	1	0.3412	0.3525	H34	1	0.3452	0.3558	H44	1	0.3493	0.3591
	2	0.3369	0.3431		2	0.3407	0.3462		2	0.3446	0.3493		2	0.3485	0.3524
	3	0.3407	0.3462		3	0.3446	0.3493		3	0.3485	0.3524		3	0.3524	0.3555
	4	0.3412	0.3525		4	0.3452	0.3558		4	0.3493	0.3591		4	0.3533	0.3624
H14	1	0.3369	0.3431	H24	1	0.3407	0.3462	H34	1	0.3446	0.3493	H44	1	0.3485	0.3524
	2	0.3366	0.3369		2	0.3403	0.3399		2	0.3441	0.3428		2	0.3478	0.3458
	3	0.3403	0.3399		3	0.3441	0.3428		3	0.3478	0.3458		3	0.3515	0.3487
	4	0.3407	0.3462		4	0.3446	0.3493		4	0.3485	0.3524		4	0.3524	0.3555
H14	1	0.3369	0.3431	H24	1	0.3407	0.3462	H34	1	0.3446	0.3493	H44	1	0.3485	0.3524
	2	0.3366	0.3369		2	0.3403	0.3399		2	0.3441	0.3428		2	0.3478	0.3458
	3	0.3403	0.3399		3	0.3441	0.3428		3	0.3478	0.3458		3	0.3515	0.3487
	4	0.3407	0.3462		4	0.3446	0.3493		4	0.3485	0.3524		4	0.3524	0.3555
H14	1	0.3369	0.3431	H24	1	0.3407	0.3462	H34	1	0.3446	0.3493	H44	1	0.3485	0.3524
	2	0.3366	0.3369		2	0.3403	0.3399		2	0.3441	0.3428		2	0.3478	0.3458
	3	0.3403	0.3399		3	0.3441	0.3428		3	0.3478	0.3458		3	0.3515	0.3487
	4	0.3407	0.3462		4	0.3446	0.3493		4	0.3485	0.3524		4	0.3524	0.3555

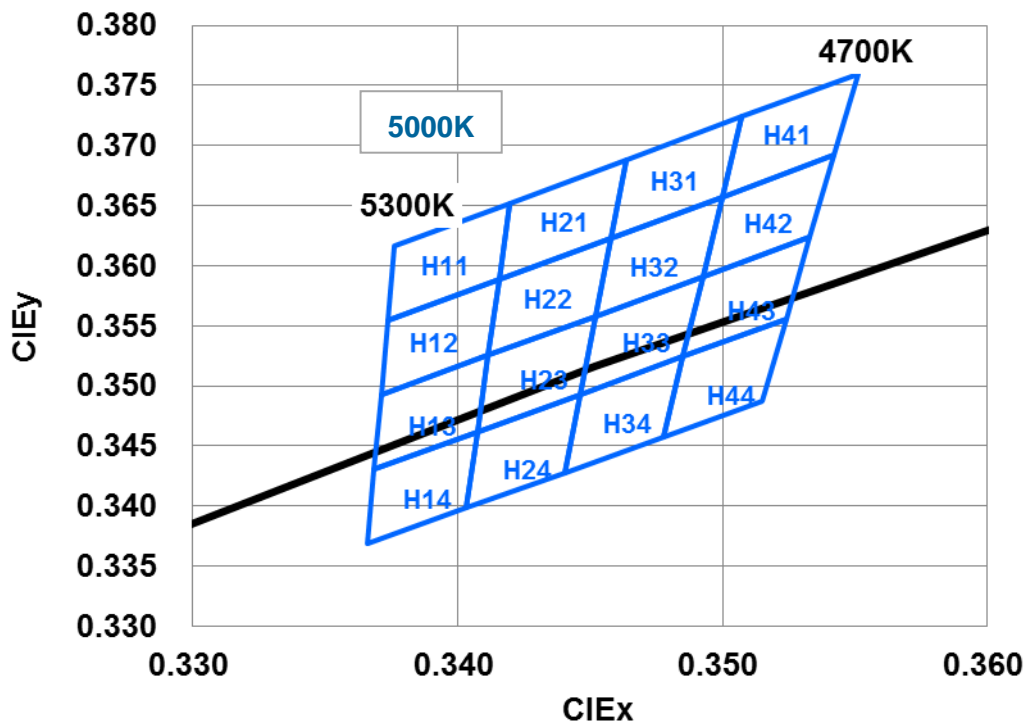

Specific Lighting LTW-2835AZIXX

5700K															
Rank	-	x	y	Rank	-	x	y	Rank	-	x	y	Rank	-	y	
J11	1	0.3207	0.3462	J21	1	0.3249	0.3501	J31	1	0.3292	0.3539	J41	1	0.3334	0.3578
	2	0.3211	0.3407		2	0.3251	0.3444		2	0.3292	0.3481		2	0.3333	0.3518
	3	0.3251	0.3444		3	0.3292	0.3481		3	0.3333	0.3518		3	0.3374	0.3554
	4	0.3249	0.3501		4	0.3292	0.3539		4	0.3334	0.3578		4	0.3376	0.3616
J12	1	0.3207	0.3462	J22	1	0.3249	0.3501	J32	1	0.3292	0.3539	J42	1	0.3334	0.3578
	1	0.3211	0.3407		1	0.3251	0.3444		1	0.3292	0.3481		1	0.3333	0.3518
	2	0.3215	0.3353		2	0.3254	0.3388		2	0.3293	0.3423		2	0.3332	0.3458
	3	0.3254	0.3388		3	0.3293	0.3423		3	0.3332	0.3458		3	0.3371	0.3493
J13	4	0.3251	0.3444	J23	4	0.3292	0.3481	J33	4	0.3333	0.3518	J43	4	0.3374	0.3554
	1	0.3211	0.3407		1	0.3251	0.3444		1	0.3292	0.3481		1	0.3333	0.3518
	1	0.3215	0.3353		1	0.3254	0.3388		1	0.3293	0.3423		1	0.3332	0.3458
	2	0.3218	0.3298		2	0.3256	0.3331		2	0.3293	0.3364		2	0.3331	0.3398
J14	3	0.3256	0.3331	J24	3	0.3293	0.3364	J34	3	0.3331	0.3398	J44	3	0.3369	0.3431
	4	0.3254	0.3388		4	0.3293	0.3423		4	0.3332	0.3458		4	0.3371	0.3493
	1	0.3215	0.3353		1	0.3254	0.3388		1	0.3293	0.3423		1	0.3332	0.3458
	1	0.3218	0.3298		1	0.3256	0.3331		1	0.3293	0.3364		1	0.3331	0.3398
J14	2	0.3222	0.3243	J24	2	0.3258	0.3275	J34	2	0.3294	0.3306	J44	2	0.3330	0.3338
	3	0.3258	0.3275		3	0.3294	0.3306		3	0.3330	0.3338		3	0.3366	0.3369
	4	0.3256	0.3331		4	0.3293	0.3364		4	0.3331	0.3398		4	0.3369	0.3431
	1	0.3218	0.3298		1	0.3256	0.3331		1	0.3293	0.3364		1	0.3331	0.3398

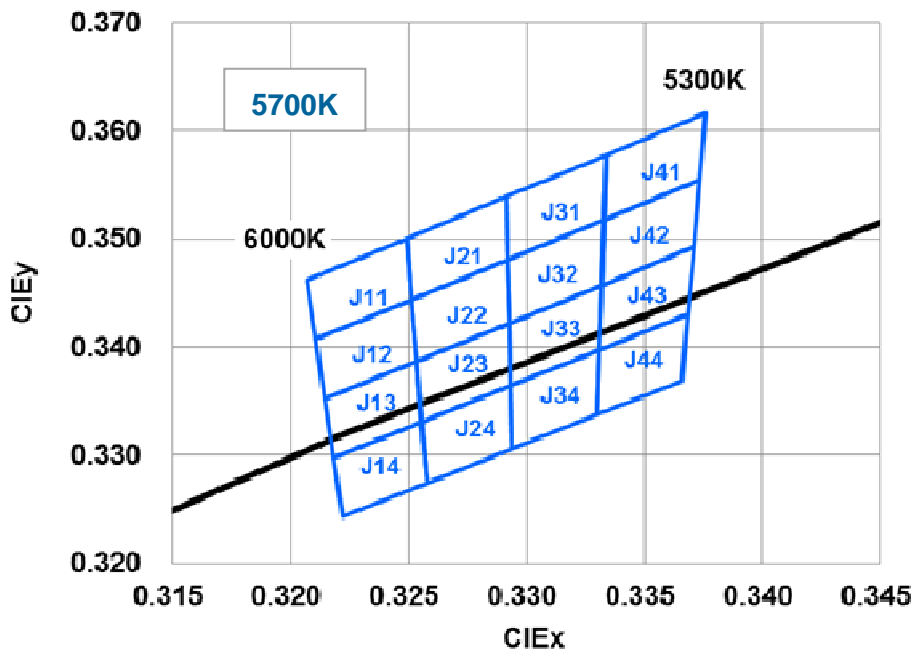

Specific Lighting LTW-2835AZlXX

6500K															
Rank	-	x	y	Rank	-	x	y	Rank	-	x	y	Rank	-	y	
K11	1	0.3028	0.3304	K21	1	0.3072	0.3348	K31	1	0.3117	0.3393	K41	1	0.3161	0.3437
	2	0.3038	0.3256		2	0.3081	0.3299		2	0.3124	0.3341		2	0.3166	0.3384
	3	0.3081	0.3299		3	0.3124	0.3341		3	0.3166	0.3384		3	0.3209	0.3426
	4	0.3072	0.3348		4	0.3117	0.3393		4	0.3161	0.3437		4	0.3205	0.3481
K12	1	0.3028	0.3304	K22	1	0.3072	0.3348	K32	1	0.3117	0.3393	K42	1	0.3161	0.3437
	2	0.3038	0.3256		2	0.3081	0.3299		2	0.3124	0.3341		2	0.3166	0.3384
	3	0.3089	0.3249		3	0.3131	0.3290		3	0.3172	0.3330		3	0.3213	0.3371
	4	0.3081	0.3299		4	0.3124	0.3341		4	0.3166	0.3384		4	0.3209	0.3426
K13	1	0.3038	0.3256	K23	1	0.3081	0.3299	K33	1	0.3124	0.3341	K43	1	0.3166	0.3384
	2	0.3048	0.3209		2	0.3089	0.3249		2	0.3131	0.3290		2	0.3172	0.3330
	3	0.3058	0.3161		3	0.3098	0.3200		3	0.3138	0.3238		3	0.3177	0.3277
	4	0.3098	0.3200		4	0.3138	0.3238		4	0.3177	0.3277		4	0.3217	0.3316
K14	1	0.3089	0.3249	K24	1	0.3131	0.3290	K34	1	0.3172	0.3330	K44	1	0.3213	0.3371
	2	0.3048	0.3209		2	0.3089	0.3249		2	0.3131	0.3290		2	0.3172	0.3330
	3	0.3106	0.3150		3	0.3098	0.3200		3	0.3138	0.3238		3	0.3177	0.3277
	4	0.3098	0.3200		4	0.3138	0.3238		4	0.3177	0.3277		4	0.3217	0.3316
	1	0.3058	0.3161		1	0.3098	0.3200		1	0.3138	0.3238		1	0.3177	0.3277
	2	0.3068	0.3113		2	0.3106	0.3150		2	0.3145	0.3187		2	0.3183	0.3224
	3	0.3106	0.3150		3	0.3145	0.3187		3	0.3183	0.3224		3	0.3221	0.3261
	4	0.3098	0.3200		4	0.3138	0.3238		4	0.3177	0.3277		4	0.3217	0.3316
	1	0.3058	0.3161		1	0.3098	0.3200		1	0.3138	0.3238		1	0.3177	0.3277

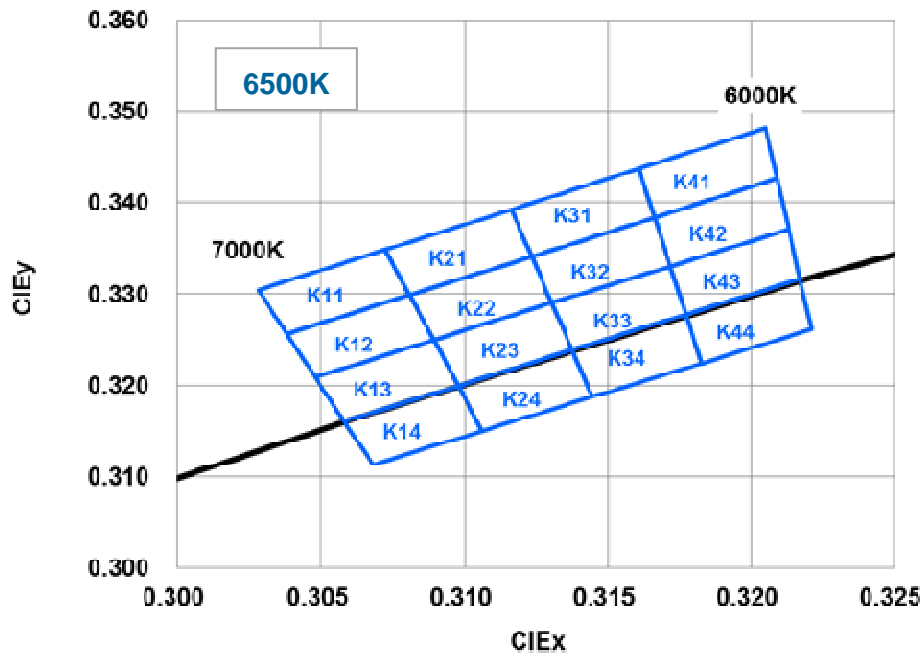

Tolerance on each Hue bin (x,y) is +/- 0.007

**Specific Lighting
LTW-2835AZIXX**

5.2 Flux Bin

2700K	Luminous Flux Spec. Table	
Φ_v Bin	Lumen (lm) at $I_F = 65 \text{ mA}$	
	Min	Max
QR	30	32
RS	32	34

4000K	Luminous Flux Spec. Table	
Φ_v Bin	Lumen (lm) at $I_F = 65 \text{ mA}$	
	Min	Max
RS	32	34
SU	34	36

3000K	Luminous Flux Spec. Table	
Φ_v Bin	Lumen (lm) at $I_F = 65 \text{ mA}$	
	Min	Max
QR	30.5	32.5
RS	32.5	34.5

5000K	Luminous Flux Spec. Table	
Φ_v Bin	Lumen (lm) at $I_F = 65 \text{ mA}$	
	Min	Max
RS	33	35
SU	35	37

3500K	Luminous Flux Spec. Table	
Φ_v Bin	Lumen (lm) at $I_F = 65 \text{ mA}$	
	Min	Max
QR	31	33
RS	33	35

5700K	Luminous Flux Spec. Table	
Φ_v Bin	Lumen (lm) at $I_F = 65 \text{ mA}$	
	Min	Max
RS	32.5	34.5
SU	34.5	36.5

6500K	Luminous Flux Spec. Table	
Φ_v Bin	Lumen (lm) at $I_F = 65 \text{ mA}$	
	Min	Max
RS	32	34
SU	34	36

Tolerance on each Luminous Flux bin is +/- 10%.

Specific Lighting LTW-2835AZIXX

5.3 Voltage Bin

V _F Spec. Table		
V _F Bin	Forward Voltage (volts) at I _F = 65mA	
	Min	Max
V0	2.65	2.75
V1	2.75	2.85
V2	2.85	2.95
V3	2.95	3.05

Tolerance on each Forward Voltage bin is +/- 0.1V

6. Bin Code List

Example: V1/SU/G11

Forward Voltage Rank	Luminous Flux Rank	Color Rank
V1	SU	G11

**Specific Lighting
LTW-2835AZIXX**

7. Reflow Soldering Characteristics

For Reflow Process:

Preheating : 140°C~160°C±5°C, within 2 minutes.

Operation heating : 260°C(Max.) within 10 seconds.(Max)

Gradual Cooling (Avoid quenching).

Lead solder		Lead-free solder	
Pre-heat	120-150°C	Pre-heat	150-200°C
Pre-heat time	120 sec.Max.	Pre-heat time	120 sec.Max.
Peak Temperature	240°C Max.	Peak Temperature	260°C Max.
Soldering time condition	10 sec.Max.	Soldering time condition	10 sec.Max.

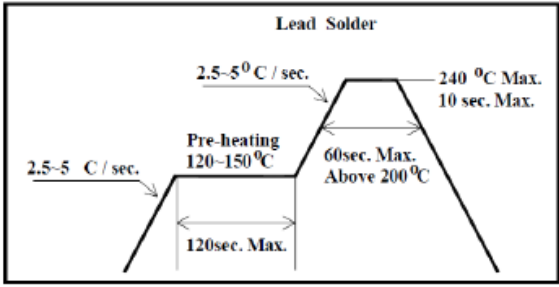
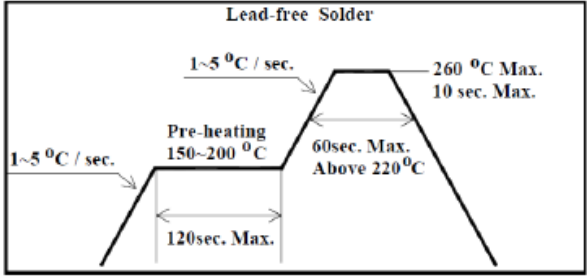
 <p>Lead Solder</p> <p>2.5-5 °C / sec. (Pre-heat)</p> <p>2.5-5 °C / sec. (Main heat)</p> <p>240 °C Max. 10 sec. Max. (Peak)</p> <p>60sec. Max. Above 200 °C (Soak)</p> <p>120sec. Max. (Pre-heat)</p>	 <p>Lead-free Solder</p> <p>1-5 °C / sec. (Pre-heat)</p> <p>1-5 °C / sec. (Main heat)</p> <p>260 °C Max. 10 sec. Max. (Peak)</p> <p>60sec. Max. Above 220 °C (Soak)</p> <p>120sec. Max. (Pre-heat)</p>
---	---

Notes:

The encapsulated material of the LEDs is silicone . Therefore the LEDs have a soft surface on the top of package. The pressure to the top surface will be influence to the reliability of the LEDs. Precautions should be taken to avoid the strong pressure on the encapsulated part. So when using the picking up nozzle, the pressure on the silicone resin should be proper.

This product is qualified as Moisture sensitive Level 3 per JEDEC J-STD-020 Precaution when handing this moisture sensitive product is important to ensure the reliability of the product

Specific Lighting LTW-2835AZIXX

8. Reliability Test

No	Test item	Test Condition	Duration	Number of Damaged
1	Steady State Operating Life of High Temperature (HTOL)	Ts=85°C, I _F =120mA	1000 hrs	0/20
2	Steady State Operating Life of Low Temperature (LTOL)	Ta=-40°C, I _F =120mA	1000 hrs	0/20
3	Pulse Wet Operating Life of High Temperature (PWHTOL)	60°C/90%RH, I _F =120mA 30mins ON/30min OFF	500 hrs	0/20
4	High Temperature Storage (HTS)	100°C	1000 hrs	0/20
5	Low Temperature Storage (LTS)	-40°C	1000 hrs	0/20
6	Thermal Cycle (TC)	-40°C~100°C 30min dwell 5min transfer	200 cycle	0/20
7	Thermal Shock (TS)	-40°C~100°C 20min dwell 20sec transfer	200 cycle	0/20
8	Solder Resistance (SR)	265°C, 3X MSL	5sec	0/20
9	Solder Ability (SA)	245°C 5sec, 95% coverage	5sec	0/11
10	Salt Spread (SS)	35°C, 30g/m ² /day	48hrs	0/11

Criteria for Judging the Damage

Item	Symbol	Test Condition	Criteria for Judgment	
			Min.	Max.
Forward Voltage	V _f	I _F =Typical Current		U.S.L. x 1.1
Luminous Flux	L _m	I _F =Typical Current	L.S.L. x 0.7	
CCX&CCY	x,y	I _F =Typical Current		Shift<0.02

Specific Lighting LTW-2835AZIXX

9. User Guide

■ Cleaning

Do not use unspecified chemical liquid to clean LED they could harm the package. If cleaning is necessary, immerse the LED in ethyl alcohol or isopropyl alcohol at normal temperature for less than one minute.

■ Recommend Printed Circuit Board Attachment Pad

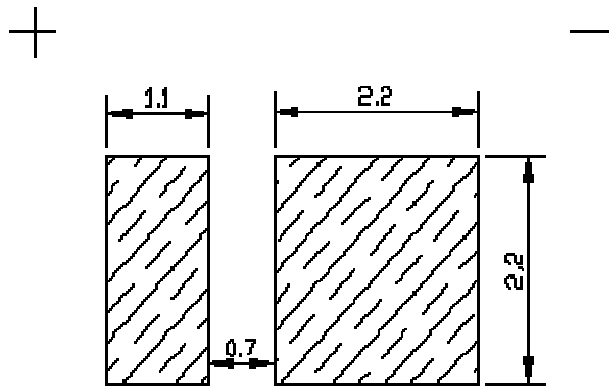

■ Package Dimensions of Tape

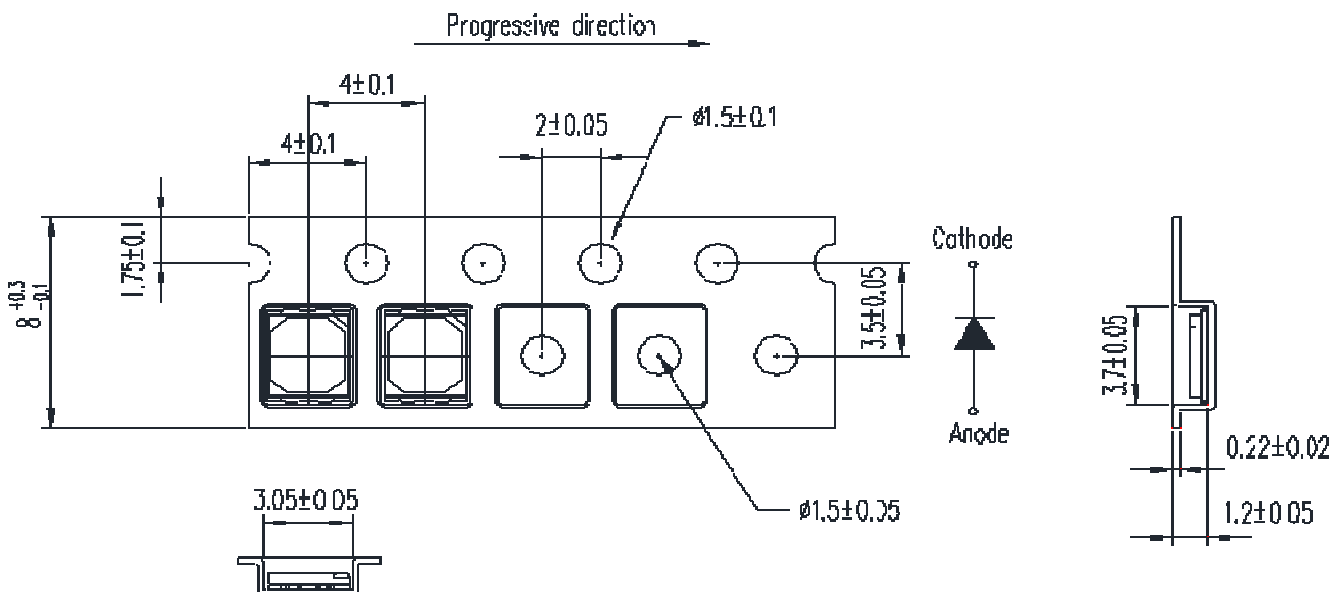



Specific Lighting
LTW-2835AZIXX

■ Package Dimensions of Reel

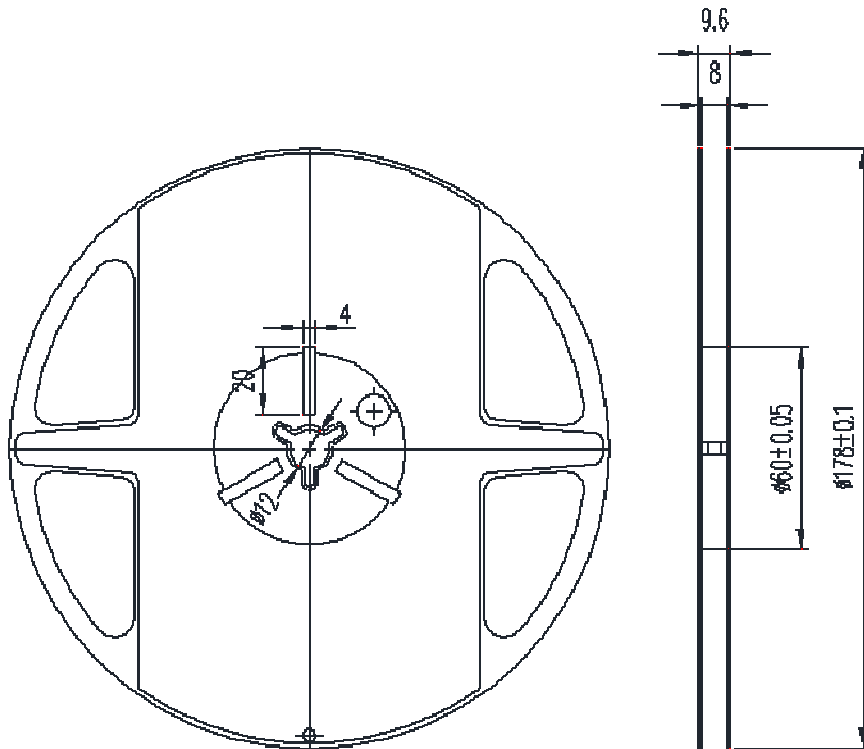

Note: The tolerances unless mentioned is ± 0.1 mm, Unit=mm

Notes:

- (1) Quantity : 3,000pcs/Reel
- (2) Cumulative Tolerance : Cumulative Tolerance/10 pitches to be ± 0.2 mm
- (3) Adhesion Strength of Cover Tape : Adhesion strength to be 0.1-0.7N when the cover tape is turned off from the carrier tape at the angle of 10° to the carrier tape
- (4) Package : P/N, Manufacturing data Code No. and quantity to be indicated on a damp proof Package.

Specific Lighting LTW-2835AZIXX

10. Cautions

10.1 Application

The LEDs described here are intended to be used for ordinary electronic equipment (such as office equipment, communication equipment and household applications). Consult Liteon's Sales in advance for information on applications in which exceptional reliability is required, particularly when the failure or malfunction of the LEDs may directly jeopardize life or health (such as in aviation, transportation, traffic control equipment, medical and life support systems and safety devices).

10.2 Storage

This product is qualified as Moisture sensitive Level 3 per JEDEC J-STD-020 Precaution when handling this moisture sensitive product is important to ensure the reliability of the product.

The package is sealed:

The LEDs should be stored at 30°C or less and 90%RH or less. And the LEDs are limited to use within one year, while the LEDs is packed in moisture-proof package with the desiccants inside.

The package is opened:

The LEDs should be stored at 30°C or less and 60%RH or less. Moreover, the LEDs are limited to solder process within 168hrs. If exceeding the storage limiting time since opened, that we recommended to bake LEDs at 60°C at least 24hrs. To seal the remainder LEDs return to package, it's recommended to be with workable desiccants in original package.

10.3 Cleaning

Use alcohol-based cleaning solvents such as isopropyl alcohol to clean the LED if necessary.

10.4 Drive Mode

An LED is a current-operated device. In order to ensure intensity uniformity on multiple LEDs connected in parallel in an application, it is recommended that a current limiting resistor be incorporated in the drive circuit, in series with each LED as shown in Circuit A below

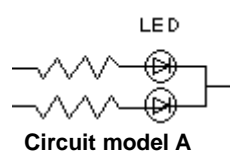

(A) Recommended circuit.

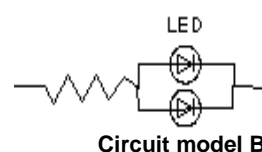

Specific Lighting LTW-2835AZIXX

(B) The brightness of each LED might appear different due to the differences in the I-V characteristics of those LEDs.

10.5 ESD (Electrostatic Discharge)

Static Electricity or power surge will damage the LED. Suggestions to prevent ESD damage:

- Use of a conductive wrist band or anti-electrostatic glove when handling these LEDs.
- All devices, equipment, and machinery must be properly grounded.
- Work tables, storage racks, etc. should be properly grounded.
- Use ion blower to neutralize the static charge which might have built up on surface of the LED's plastic lens as a result of friction between LEDs during storage and handling.

ESD-damaged LEDs will exhibit abnormal characteristics such as high reverse leakage current, low forward voltage, or "no lightup" at low currents. To verify for ESD damage, check for "light up" and V_f of the suspect LEDs at low currents. The V_f of "good" LEDs should be $>2.0V@0.1mA$ for InGaN product and $>1.4V@0.1mA$ for AlInGaP product.

10.6 Suggested Checking List:

- Training and Certification
 1. Everyone working in a static-safe area is ESD-certified?
 2. Training records kept and re-certification dates monitored?
- Static-Safe Workstation & Work Areas
 1. Static-safe workstation or work-areas have ESD signs?
 2. All surfaces and objects at all static-safe workstation and within 1 ft measure less than 100V?
 3. All ionizer activated, positioned towards the units?
 4. Each work surface mats grounding is good?
- Personnel Grounding
 1. Every person (including visitors) handling ESD sensitive (ESDS) items wear wrist strap, heel strap or conductive shoes with conductive flooring?
 2. If conductive footwear used, conductive flooring also present where operator stand or walk?
 3. Garments, hairs or anything closer than 1 ft to ESD items measure less than 100V*?

Specific Lighting LTW-2835AZIXX

4. Every wrist strap or heel strap/conductive shoes checked daily and result recorded for all DLs?

5. All wrist strap or heel strap checkers calibration up to date?

Note: *50V for Blue LED.

■ Device Handling

1. Every ESDS items identified by EIA-471 labels on item or packaging?

2. All ESDS items completely inside properly closed static-shielding containers when not at static-safe workstation?

3. No static charge generators (e.g. plastics) inside shielding containers with ESDS items?

4. All flexible conductive and dissipative package materials inspected before reuse or recycle?

■ Others

1. Audit result reported to entity ESD control coordinator?

2. Corrective action from previous audits completed?

3. Are audit records complete and on file?

10.7 Others:

- Do not put any pressure on the light emitting surface either by finger or any hand tool and do not stack the products. Stress or pressure may cause damage to the wires of the LED array.
- This product is not designed for the use under any of the following conditions, please confirm the performance and reliability are well enough if you use it under any of the following conditions
- Do not use sulfur-containing materials in commercial products including the materials such as seals and adhesives that may contain sulfur.
- Do not put this product in a place with a lot of moisture (over 85% relative humidity), dew condensation, briny air, and corrosive gas (Cl, H₂S, NH₃, SO₂, NO_x, etc.), exposure to a corrosive environment may affect silver plating.
- The appearance and specifications of the product may be modified for improvement without prior notice.

**Specific Lighting
LTW-2835AZIXX**

Revision History:

Revision Date:

Last Version: (Ver -)

Version	Page	Content of Change	Date Record
1.0	all	New Part No.	11/29/2016