

# MGA-31716

## 0.1 W High Linearity Driver Amplifier



### Data Sheet

#### Description

Avago Technologies MGA-31716 is a high linearity driver MMIC Amplifier housed in a standard QFN 3X3 16 lead plastic package. It features high gain, low operating current, low noise figure with good input and output return loss. Power consumption can be further reduced by reducing the quiescent bias current using two external bias resistors. The device can be easily matched at different frequencies to obtain optimal linearity performance at those frequencies.

MGA-31716 is especially ideal for 50 Ω wireless infrastructure application operating from DC to 2 GHz frequency range. With the high linearity, excellent gain flatness and low noise figure the MGA-31716 may be utilized as a driver amplifier in the transmit chain and as a second stage LNA in the receiver chain.

This device uses Avago Technologies proprietary 0.25 μm GaAs Enhancement mode PHEMT process.

#### Pin Connections and Package Marking

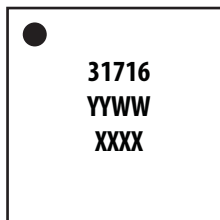

TOP VIEW

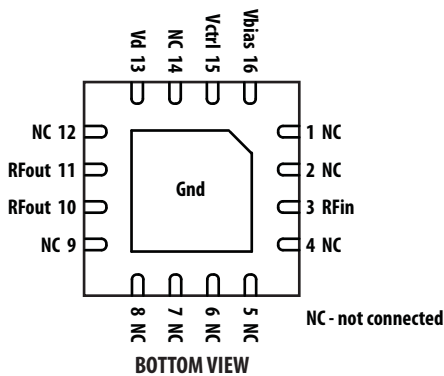

Notes:  
 Package marking provides orientation and identification  
 "31716" = Device Part Number  
 "YYWW" = Work Week and Year of manufacturing  
 "XXXX" = Last 4 digit of Lot Number

#### Features

- Very high linearity at low DC bias power <sup>[1]</sup>
- High Gain with good gain flatness
- ROHS compliant
- Good Noise Figure
- Halogen free
- Advanced enhancement-mode PHEMT Technology
- QFN 3X3 16-Lead standard package
- Lead-free MSL1

#### Specifications

At 900 MHz, Vd = 5 V, Id = 68 mA (typ) @ 25° C

- OIP3 = 39.5 dBm
- Noise Figure = 1.9 dB
- Gain = 20.6 dB
- P1dB = 22.5 dBm
- IRL = 15.5 dB, ORL = 15.5 dB

Note:

1. The MGA-31716 has a superior LFOM of 16.5 dB. Linearity-Figure-of-Merit (LFOM) is the ratio of OIP3 to total DC bias power.



**Attention: Observe precautions for handling electrostatic sensitive devices.**

ESD Machine Model = 60 V  
 ESD Human Body Model = 300 V  
 Refer to Avago Application Note A004R:  
 Electrostatic Discharge, Damage and Control.

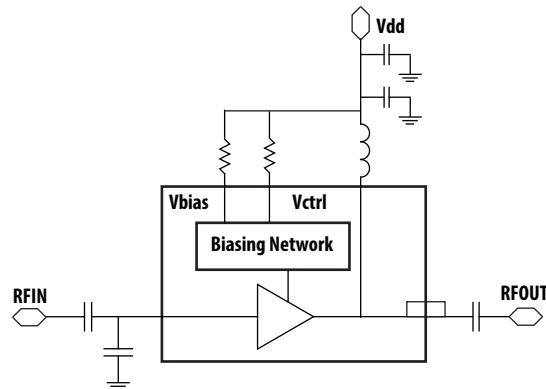

Figure 1. Simplified Application Circuit

**Table 1. MGA-31716 Absolute Maximum Rating** <sup>[1]</sup>  $T_A = 25^\circ\text{C}$ 

Symbol	Parameter	Units	Absolute Maximum
$V_{d, \max}$	Drain Voltage	V	5.5
$V_{\text{bias}, \max}$	Bias Voltage	V	5.5
$V_{\text{ctrl}, \max}$	Control Voltage	V	5.5
$P_d$	Power Dissipation <sup>[2]</sup>	mW	605
$P_{\text{in}}$	CW RF Input Power	dBm	24
$T_j$	Junction Temperature	$^\circ\text{C}$	150
$T_{\text{stg}}$	Storage Temperature	$^\circ\text{C}$	-65 to 150
$T_{\text{amb}}$	Ambient Temperature	$^\circ\text{C}$	-40 to 85

**Thermal Resistance**

**Thermal Resistance** <sup>[3]</sup>  
 $(V_d = 5.0\text{ V}, T_c = 85^\circ\text{C}) \theta_{jc} = 67.0^\circ\text{C/W}$

Notes:

1. Operation of this device in excess of any of these limits may cause permanent damage
2. Source lead temperature is  $25^\circ\text{C}$ . Derate  $14.9\text{ mW}/^\circ\text{C}$  for  $T_L > 130.0^\circ\text{C}$ .
3. Thermal resistance measured using  $150^\circ\text{C}$  Infra-Red Microscopy Technique.

**Table 2. MGA-31716 Electrical Specification** <sup>[1]</sup> $T_C = 25^\circ\text{C}$ ,  $V_d = 5.0\text{ V}$ , unless otherwise noted

Symbol	Parameter and Test Condition	Frequency	Units	Min.	Typ.	Max.
$I_{ds}$	Quiescent Current	450 MHz	mA	37	60	83
		900 MHz			68	
		1500 MHz			50	
NF	Noise Figure	450 MHz	dB	-	1.8	2.7
		900 MHz			1.9	
		1500 MHz			2.1	
Gain	Gain	450 MHz	dB	18.5	21.0	21.5
		900 MHz			20.6	
		1500 MHz			20.0	
OIP3 <sup>[2, 4]</sup>	Output Third Order Intercept Point	450 MHz	dBm	37	42.1	-
		900 MHz			39.5	
		1500 MHz			40.5	
LFOM <sup>[3]</sup>	Linearity Figure of Merit	450 MHz	dBm		16.2	
		900 MHz			14.2	
		1500 MHz			16.4	
P1dB	Output Power at 1dB Gain Compression	450 MHz	dBm	19.5	22.1	-
		900 MHz			22.5	
		1500 MHz			21.1	
PAE	Power Added Efficiency at P1dB	450 MHz	%		50.9	
		900 MHz			51.9	
		1500 MHz			64.0	
IRL	Input Return Loss	450 MHz	dB		16.6	
		900 MHz			15.5	
		1500 MHz			16.0	
ORL	Output Return Loss	450 MHz	dB		15.6	
		900 MHz			15.5	
		1500 MHz			13.0	
ISOL	Isolation	450 MHz	dB		25.2	
		900 MHz			25.7	
		1500 MHz			26.7	

Notes:

1. Measurements obtained from test circuit and demoboard detailed in Figures 46 and 47 and Table 3.
2. OIP3 test condition:  $F1 - F2 = 1\text{ MHz}$ , with input power of  $-12\text{ dBm}$  per tone measured at worst case side band.
3. LFOM is defined as  $\text{LFOM} = \text{OIP3 (in dBm)} - P_{DC} \text{ (in dBm)}$ . It is a measure of the linearity of an amplifier per unit of DC power consumed.
4. Demoboard tuned to best OIP3 with minimum over-temperature drift.

## MGA-31716 Consistency Distribution Chart [1, 2]

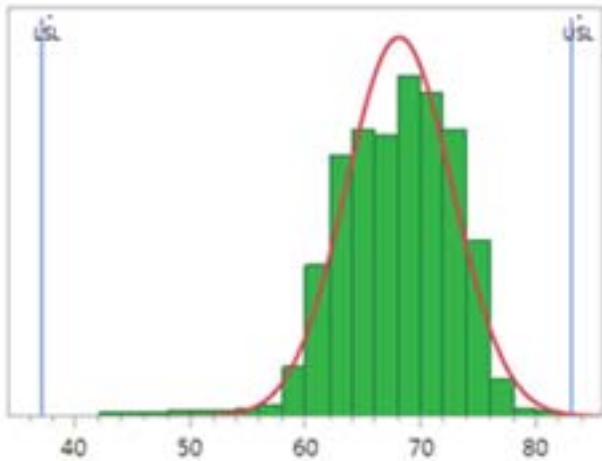

Figure 2. Id @ 900 MHz; LSL = 37 mA, Nominal = 68 mA, USL = 83 mA

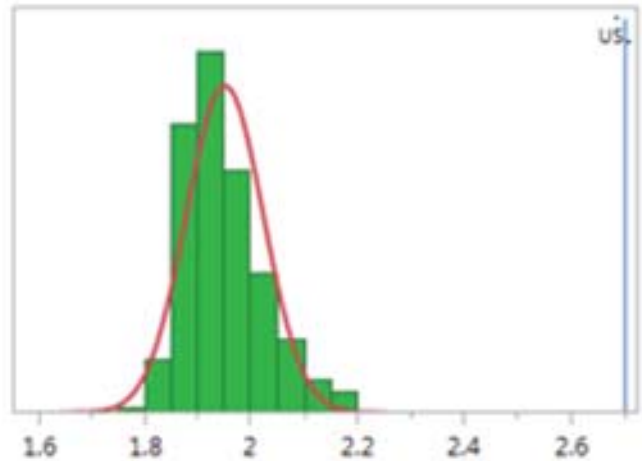

Figure 3. NF @ 900 MHz; Nominal = 1.9 dB, USL = 2.7 dB

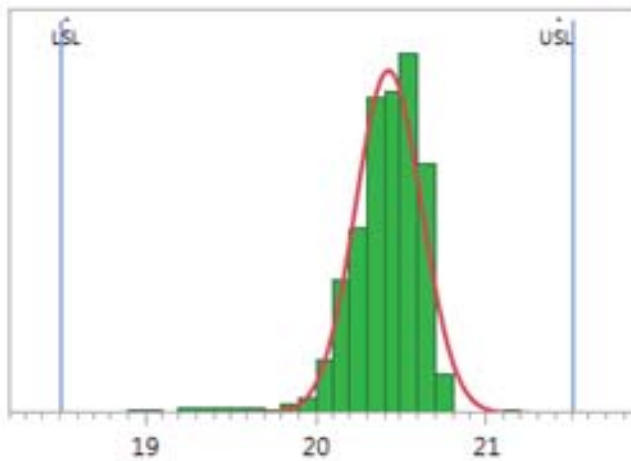

Figure 4. Gain @ 900 MHz; LSL = 18.5 dB, Nominal = 20.6 dB, USL = 21.5 dB

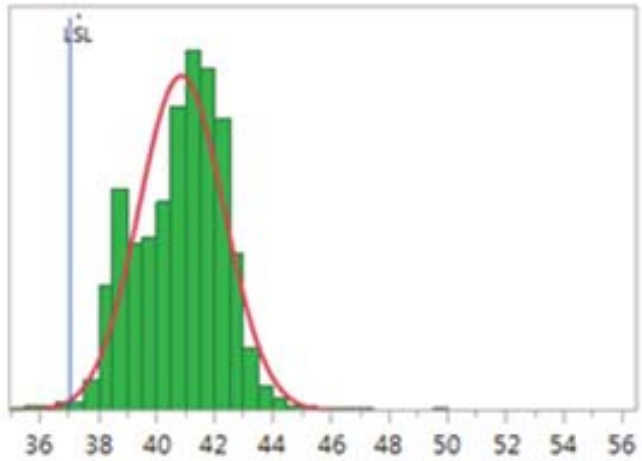

Figure 5. OIP3 @ 900 MHz; Nominal = 39.5 dBm, LSL = 37 dBm

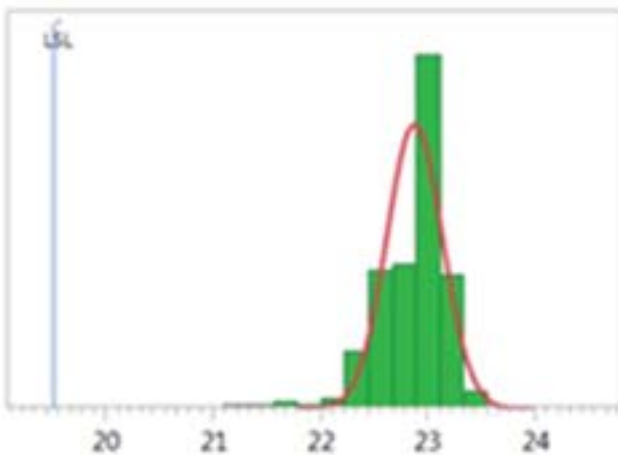

Figure 6. P1dB @ 900 MHz; Nominal = 22.5 dBm, LSL = 19.5 dBm

### Notes:

1. Data sample size is 4000 samples taken from 4 different wafers and 2 different lots. Future wafers allocated to this product may have nominal values anywhere between the upper and lower limits.
2. Measurements are made on production test board which represents a trade-off between optimal Gain, NF, OIP3 and P1dB. Circuit losses have been de-embedded from actual measurements.

# MGA-31716 Typical Performance Data for 450 MHz

$T_C = 25^\circ\text{C}$ ,  $V_d = 5.0\text{V}$ ,  $I_d = 60\text{mA}$  (Based on BOM for 450 MHz optimal linearity tuning in Table 3)

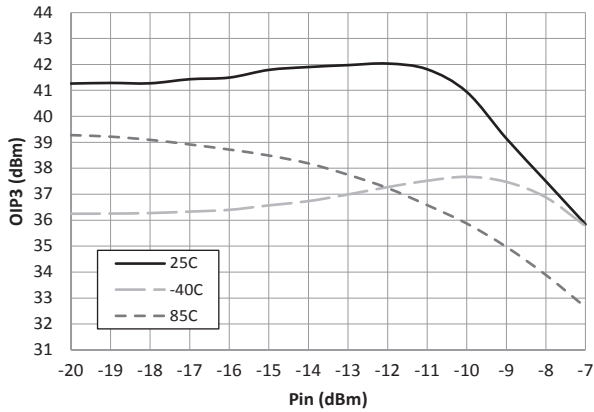

Figure 7. OIP3 vs Pin and Temperature

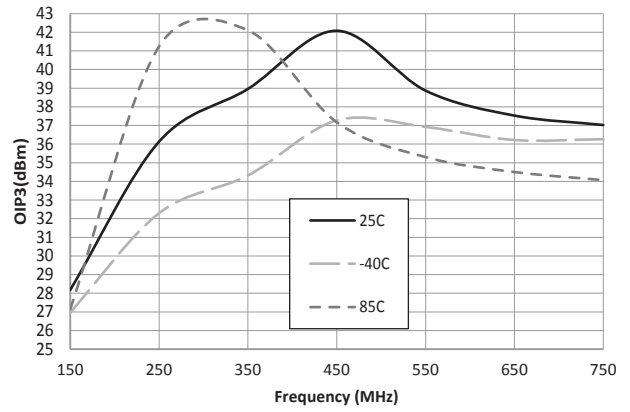

Figure 8. OIP3 vs Frequency and Temperature

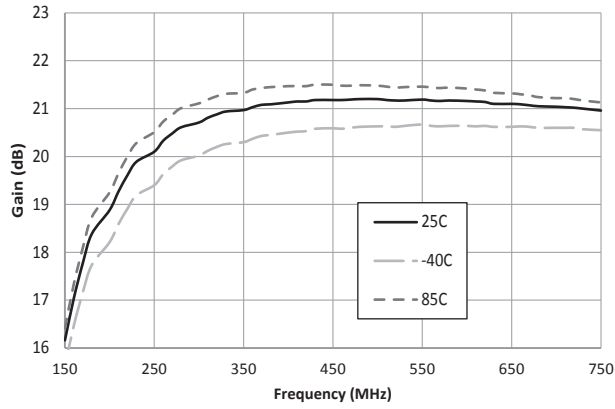

Figure 9. Gain vs Frequency and Temperature

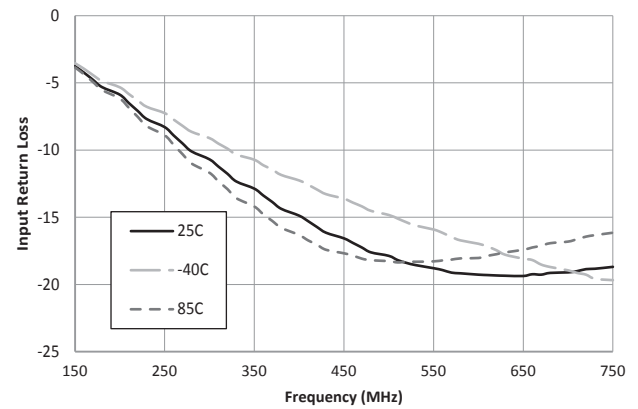

Figure 10. IRL vs Frequency and Temperature

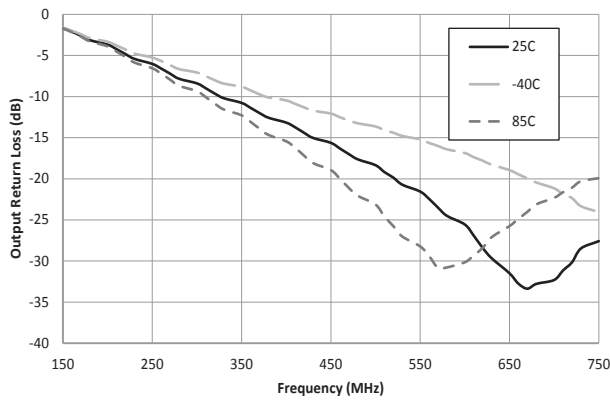

Figure 11. ORL vs Frequency and Temperature

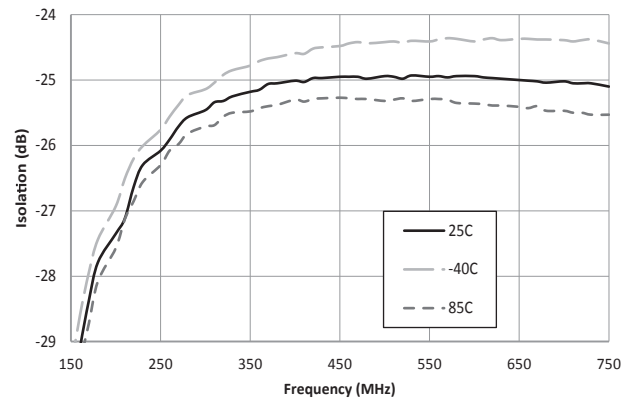

Figure 12. Isolation vs Frequency and Temperature

# MGA-31716 Typical Performance Data for 450 MHz

$T_C = 25^\circ C, V_d = 5.0 V, I_d = 60 mA$  (Based on BOM in Table 3, tuned for optimal linearity with over temperature)

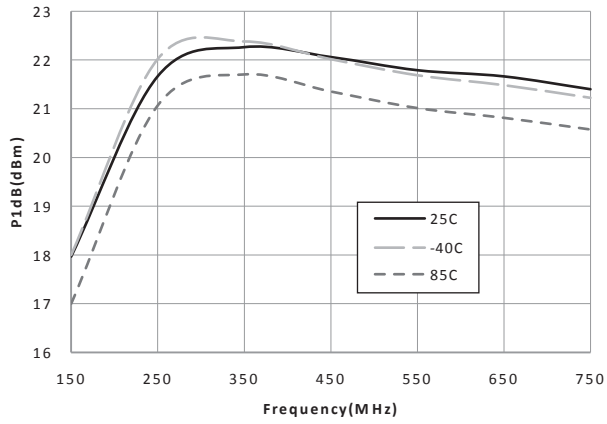

Figure 13. P1dB vs Frequency and Temperature

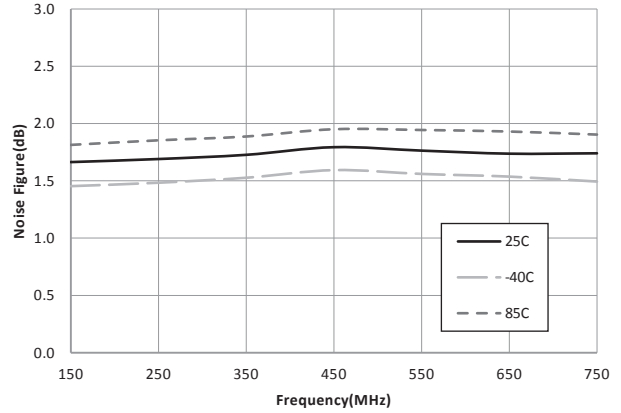

Figure 14. Noise Figure vs Frequency and Temperature

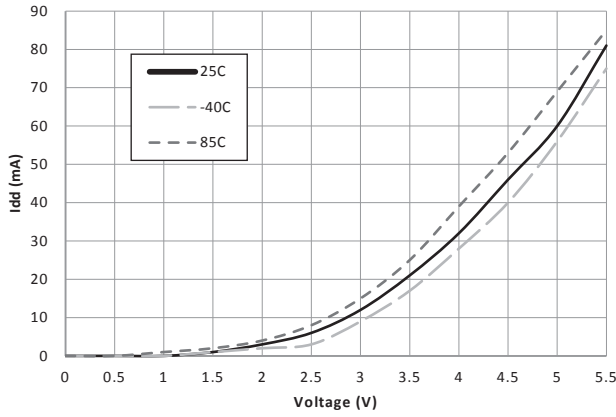

Figure 15. Current vs Voltage and Temperature

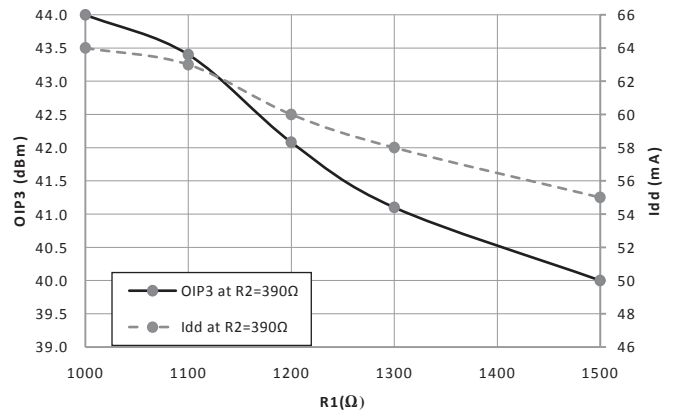

Figure 16. OIP3 and Quiescent Current with different R1 [1]

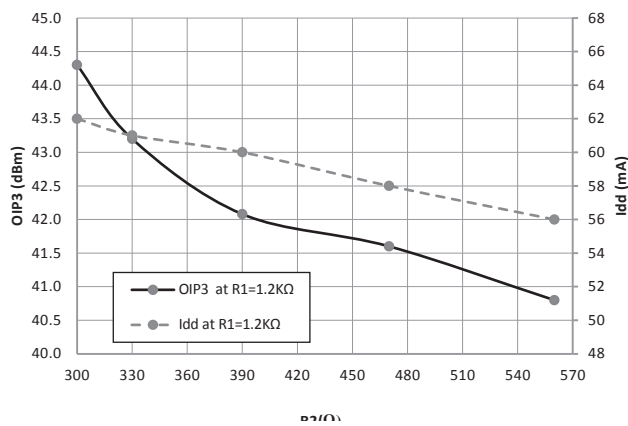

Figure 17. OIP3 and Quiescent Current with different R2 [1]

Note:

1. Vbias and Vctrl can be externally controlled by change external biasing resistors R1 = Rbias and R2 = Rctrl (as shown in Fig. 46).

## MGA-31716 Typical Performance Data for 450 MHz

$T_C = 25^\circ\text{C}$ ,  $V_d = 5.0\text{V}$ ,  $I_d = 60\text{mA}$  (Based on BOM in Table 3, tuned for optimal linearity with over temperature)

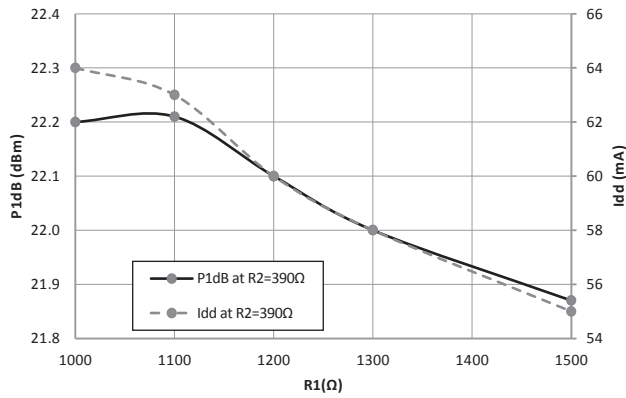

Figure 18. P1dB and Quiescent Current with different R1 [1]

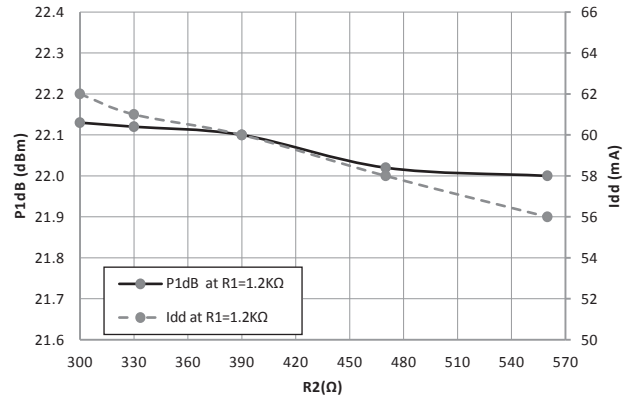

Figure 19. P1dB and Quiescent Current with different R2 [1]

Note:

1. Vbias and Vctrl can be externally controlled by change external biasing resistors R1 = Rbias and R2 = Rctrl (as shown in Fig. 46).

# MGA-31716 Typical Performance Data for 900 MHz

$T_C = 25^\circ\text{C}$ ,  $V_d = 5.0\text{V}$ ,  $I_d = 68\text{mA}$  (Based on BOM in Table 3, tuned for optimal linearity with over temperature)

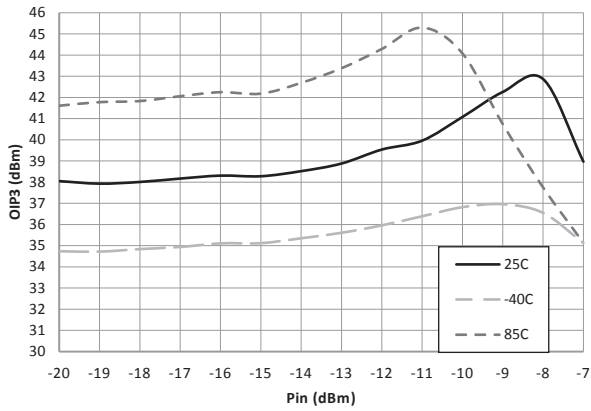

Figure 20. OIP3 vs Pin and Temperature

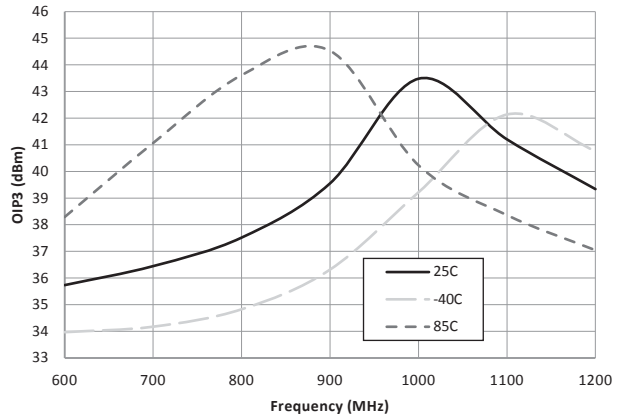

Figure 21. OIP3 vs Frequency and Temperature

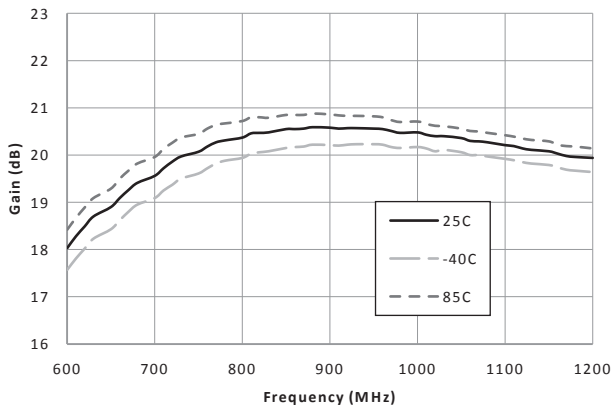

Figure 22. Gain vs Frequency and Temperature

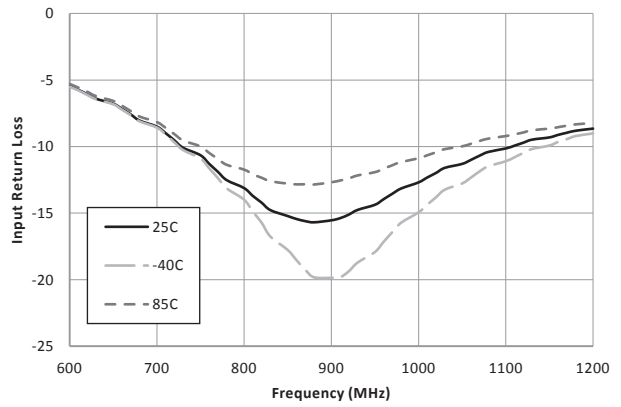

Figure 23. IRL vs Frequency and Temperature

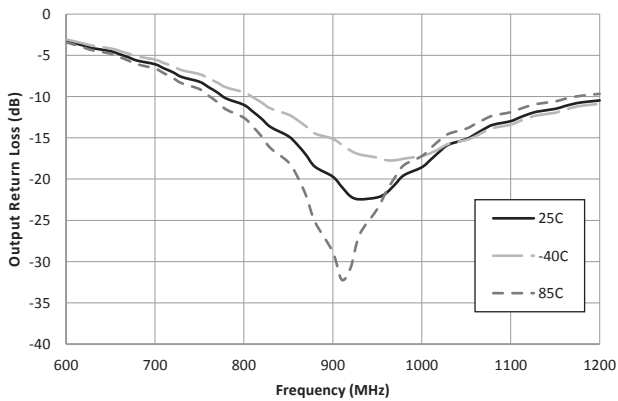

Figure 24. ORL vs Frequency and Temperature

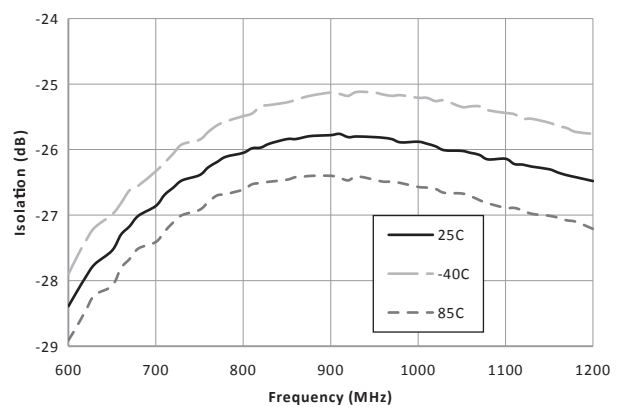

Figure 25. Isolation vs Frequency and Temperature

## MGA-31716 Typical Performance Data for 900 MHz

$T_C = 25^\circ\text{C}$ ,  $V_d = 5.0\text{V}$ ,  $I_d = 68\text{mA}$  (Based on BOM in Table 3, tuned for optimal linearity with over temperature)

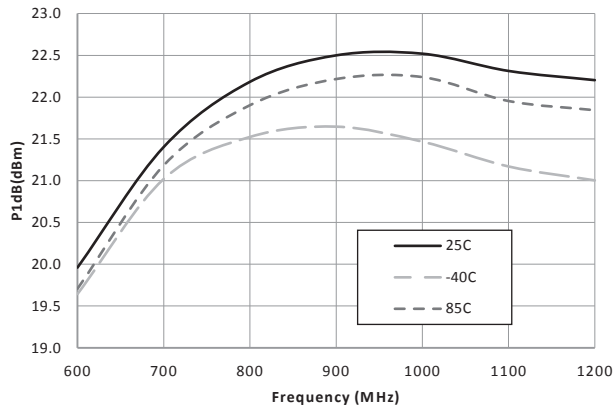

Figure 26. P1dB vs Frequency and Temperature

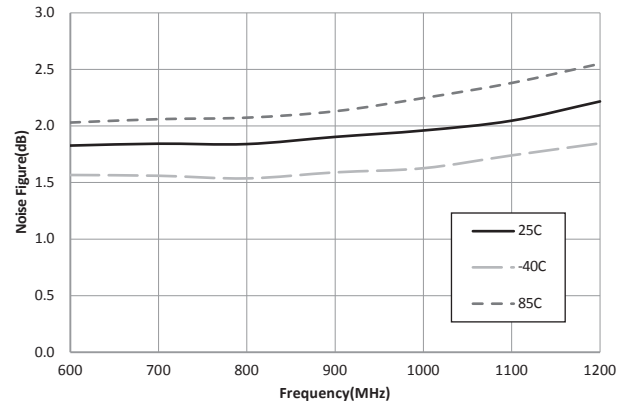

Figure 27. Noise Figure vs Frequency and Temperature

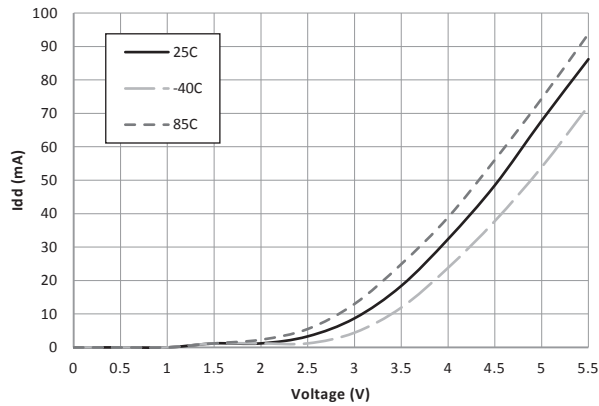

Figure 28. Current vs Voltage and Temperature

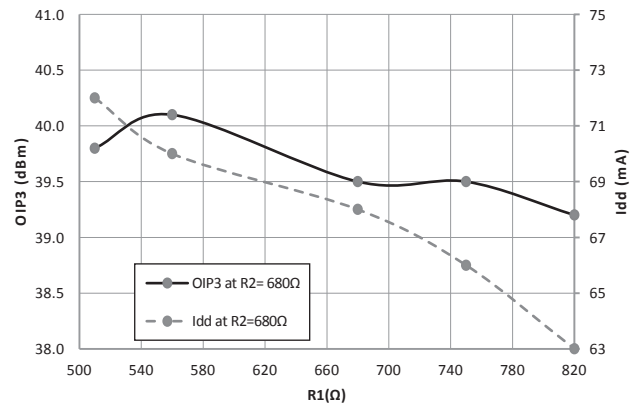

Figure 29. OIP3 and Quiescent current with different R1 [1]

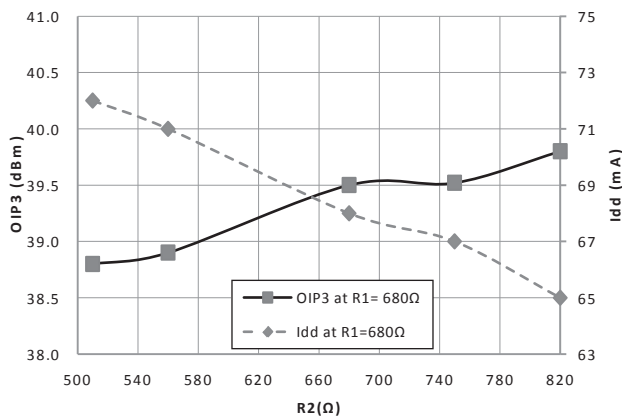

Figure 30. OIP3 and Quiescent current with different R2 [1]

Note:

1.  $V_{bias}$  and  $V_{ctrl}$  can be externally controlled by change external biasing resistors  $R1 = R_{bias}$  and  $R2 = R_{ctrl}$  (as shown in Fig. 46).



## MGA-31716 Typical Performance Data for 900 MHz

$T_C = 25^\circ\text{C}$ ,  $V_d = 5.0\text{V}$ ,  $I_d = 68\text{mA}$  (Based on BOM in Table 3, tuned for optimal linearity with over temperature)

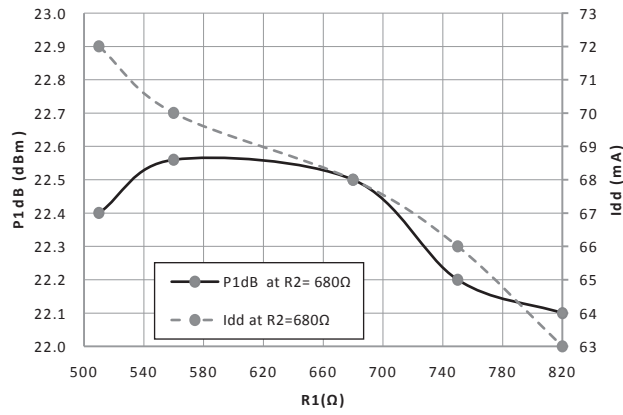

Figure 31. P1dB and Quiescent current with different R1 [1]

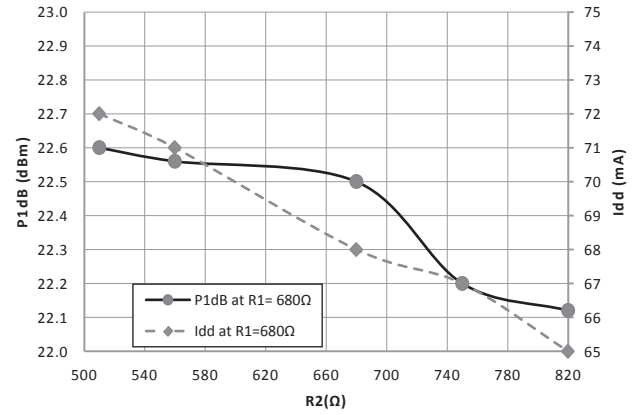

Figure 32. P1dB and Quiescent current with different R2 [1]

Note:

- Vbias and Vctrl can be externally controlled by change external biasing resistors R1 = Rbias and R2 = Rctrl (as shown in Fig. 46).

## MGA-31716 Typical Performance Data for 1500 MHz

$T_C = 25^\circ\text{C}$ ,  $V_d = 5.0\text{V}$ ,  $I_d = 50\text{mA}$  (Based on BOM in Table 3, tuned for optimal linearity with over temperature)

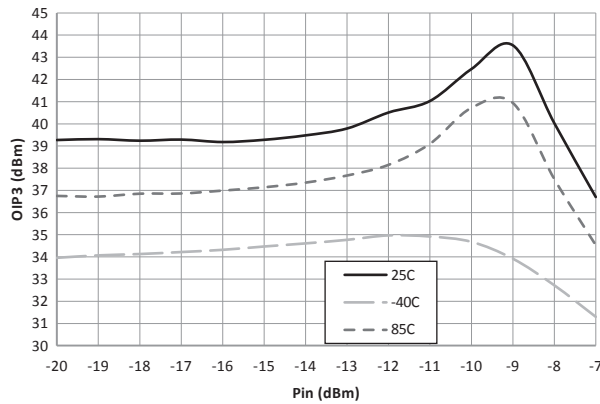

Figure 33. OIP3 vs Pin and Temperature

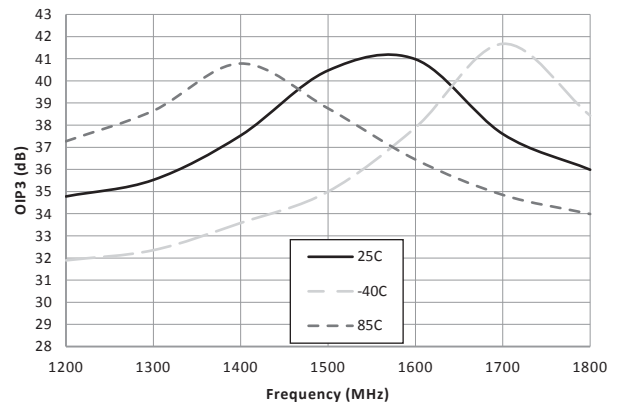

Figure 34. OIP3 vs Frequency and Temperature

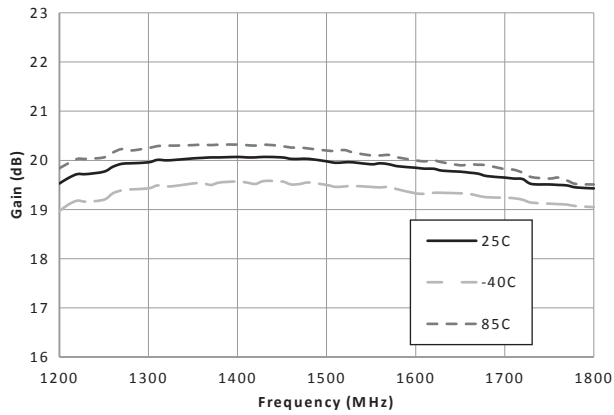

Figure 35. Gain vs Frequency and Temperature

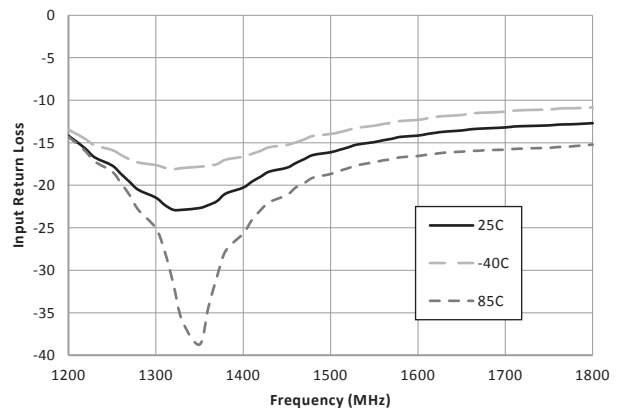

Figure 36. IRL vs Frequency and Temperature

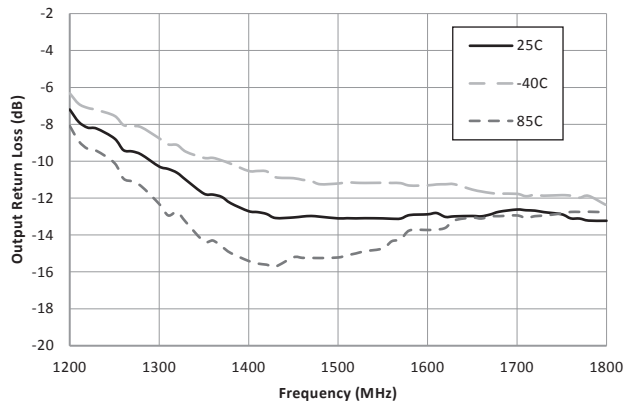

Figure 37. ORL vs Frequency and Temperature

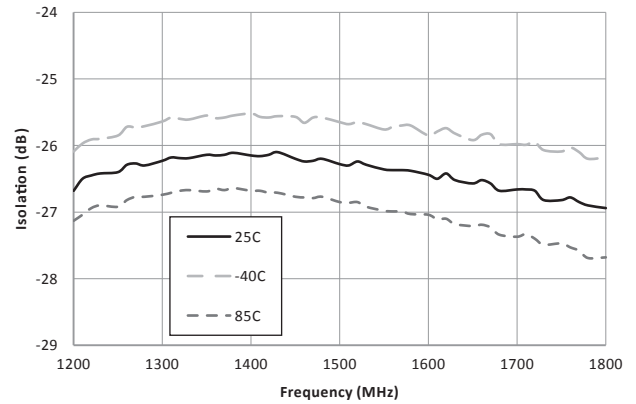

Figure 38. Isolation vs Frequency and Temperature

## MGA-31716 Typical Performance Data for 1500 MHz

$T_C = 25^\circ\text{C}$ ,  $V_d = 5.0\text{V}$ ,  $I_d = 50\text{mA}$  (Based on BOM in Table 3, tuned for optimal linearity with over temperature)

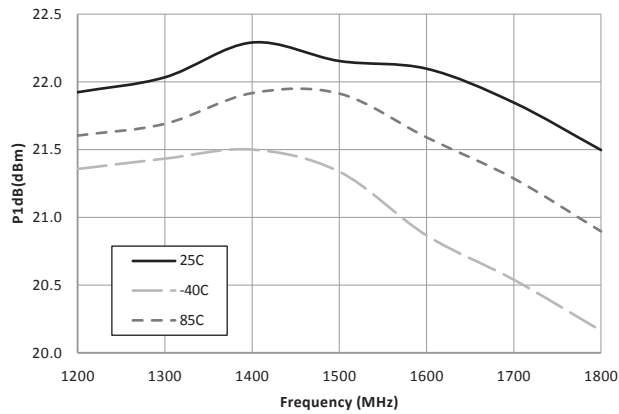

Figure 39. P1dB vs Frequency and Temperature

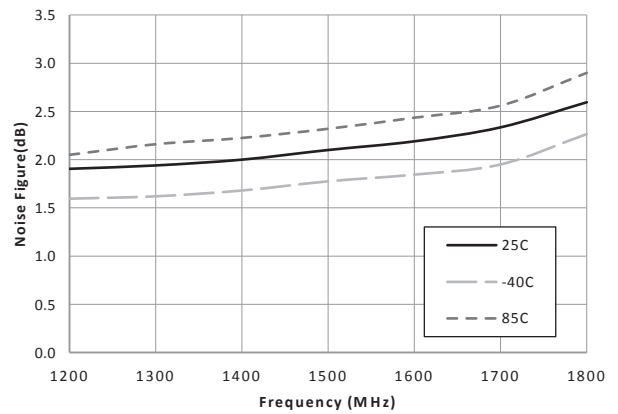

Figure 40. Noise Figure vs Frequency and Temperature

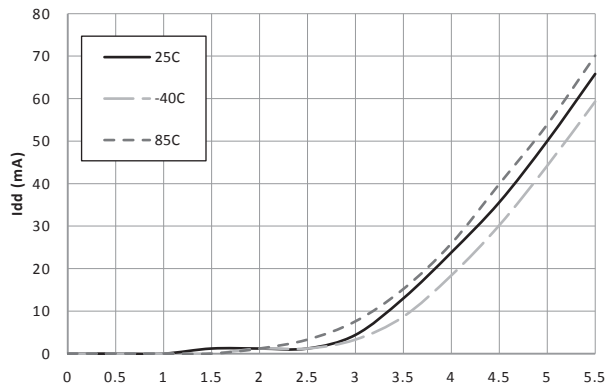

Figure 41. Current vs Voltage and Temperature

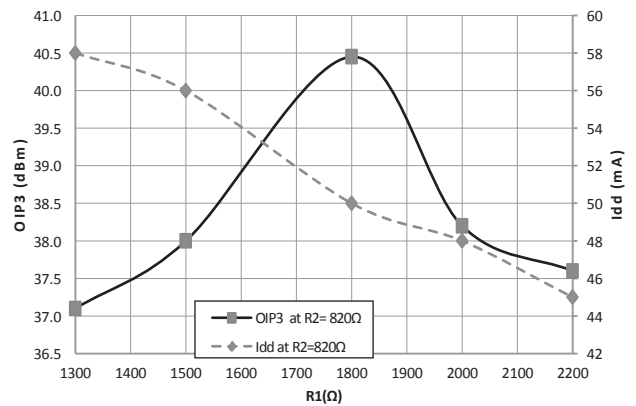

Figure 42. OIP3 and Quiescent current with different R1 [1]

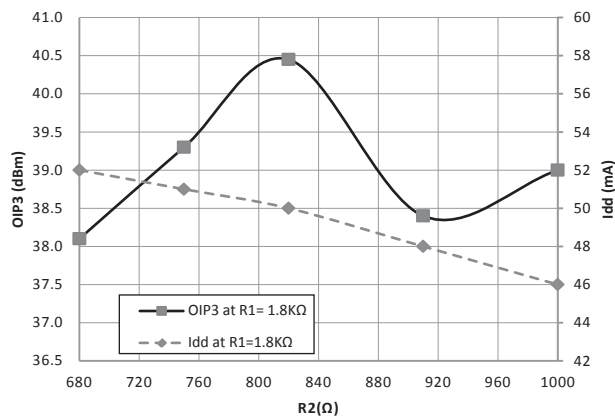

Figure 43. OIP3 and Quiescent current with different R2 [1]

Note:

1.  $V_{bias}$  and  $V_{ctrl}$  can be externally controlled by change external biasing resistors  $R1 = R_{bias}$  and  $R2 = R_{ctrl}$  (as shown in Fig. 46).

## MGA-31716 Typical Performance Data for 1500 MHz

$T_C = 25^\circ\text{C}$ ,  $V_d = 5.0\text{V}$ ,  $I_d = 50\text{mA}$  (Based on BOM in Table 3, tuned for optimal linearity with over temperature)

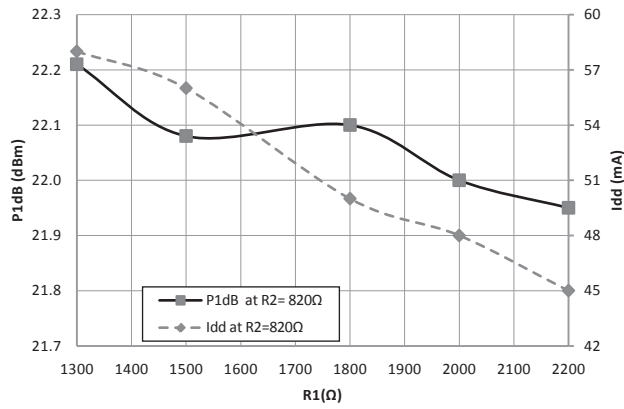

Figure 44. P1dB and Quiescent current with different R1 [1]

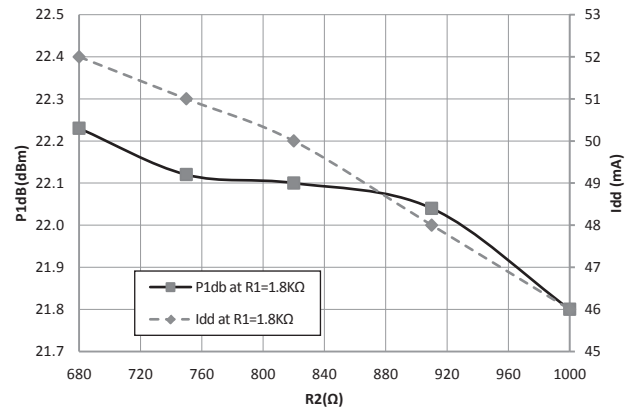

Figure 45. P1dB and Quiescent current with different R2 [1]

Note:

1.  $V_{bias}$  and  $V_{ctrl}$  can be externally controlled by change external biasing resistors  $R1 = R_{bias}$  and  $R2 = R_{ctrl}$  (as shown in Fig. 46).

## Application Circuit Description and Layout

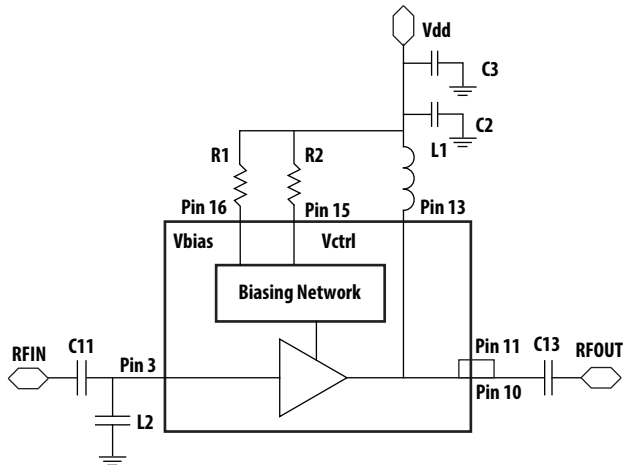

Figure 46. Application Circuit Diagram

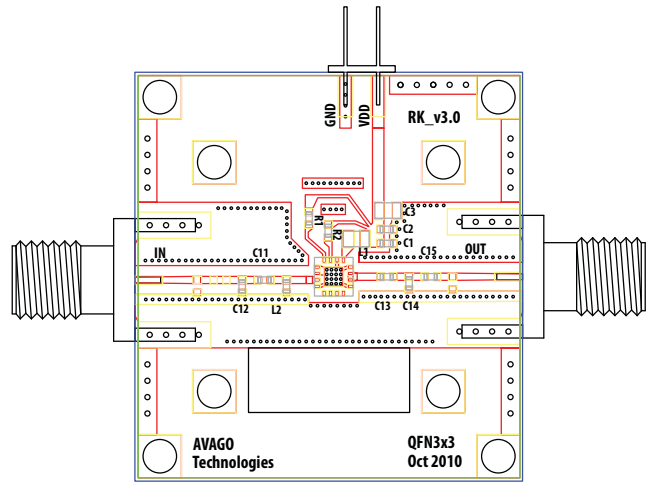

Figure 47. Demoboard

Table 3. Bill of Materials – Tuned for optimal linearity performance at different frequencies

Circuit Symbol	Size	Description			Manufacturer
		Optimum linearity at 450 MHz Value	Optimum linearity at 900 MHz Value	Optimum linearity at 1500 MHz Value	
C2	0402	5 pF	5 pF	1 pF	Murata
C3	0603	2.2 $\mu$ F	2.2 $\mu$ F	2.2 $\mu$ F	Murata
C11	0402	100 pF	100 pF	100 pF	Murata
C13	0402	12 pF	3.6 pF	1.8 pF	Murata
L1	0402	33 nH	8.2 nH	3.3 nH	Murata
L2 [2]	0402	NR	2.4 pF	1 pF	Murata
R1 [1]	0402	1.2 k $\Omega$	680 $\Omega$	1.8 k $\Omega$	KOA
R2 [1]	0402	390 $\Omega$	680 $\Omega$	820 $\Omega$	KOA

Notes:

NR – Not required in actual PCB design

1. R1 and R2 can be varied to bias Vbias and Vctrl which will provide flexibility to have the product operates at desirable Id, LFOM, and OIP3 drift across temperature also P1dB.
2. Capacitor is used at L2.

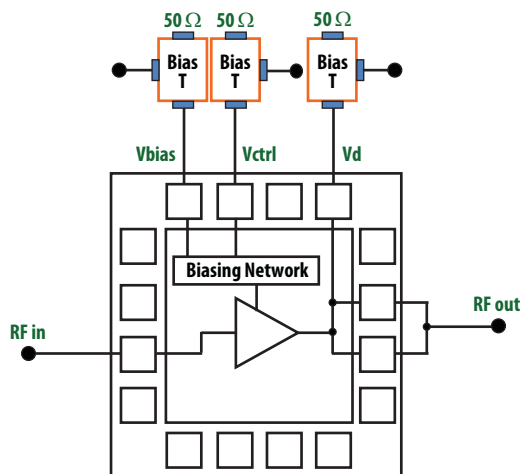

Note:

1. Measurements are conducted on 0.010 inch thick ROGER 4350. The input reference plane is at the end of the RFin pin and the output reference plane is at the end of the RFout pin as shown in Figure 48.

Figure 48. Circuit to measure de-embedded S-parameters and Noise Parameter in Table 4 and 5.

**Table 4. MGA-31716 Typical Scattering Parameters**

$T_C = 25^\circ\text{C}$ ,  $V_d = 5.0\text{V}$ ,  $I_d = 68\text{mA}$ ,  $Z_0 = 50\ \Omega$  (Data is de-embedded to the RFin & RFout pins on package. Measurements were made with Bias-Tees at  $V_d$ ,  $V_{ctrl}$  and  $V_{bias}$  in Figure 48)

Freq GHz	S11	S11	S11	S21	S21	S21	S12	S12	S12	S22	S22	S22	K Factor
	Mag.	dB	Ang.	Mag.	dB	Ang.	Mag.	dB	Ang.	Mag.	dB	Ang.	
0.10	0.160	-15.9	177.0	12.600	22.0	158.0	0.057	-25.0	-12.8	0.156	-16.1	177.0	1.046
0.20	0.152	-16.4	163.0	12.300	21.8	143.0	0.057	-24.9	-29.7	0.153	-16.3	149.0	1.056
0.30	0.150	-16.5	152.0	12.100	21.7	127.0	0.056	-25.1	-43.3	0.145	-16.8	125.0	1.068
0.40	0.149	-16.5	142.0	12.000	21.6	111.0	0.056	-25.1	-58.6	0.139	-17.2	105.0	1.072
0.50	0.155	-16.2	133.0	11.900	21.5	94.0	0.055	-25.2	-73.0	0.132	-17.6	83.8	1.080
0.60	0.157	-16.1	120.0	11.700	21.4	77.5	0.054	-25.3	-87.4	0.123	-18.2	62.3	1.091
0.70	0.162	-15.8	110.0	11.600	21.3	60.9	0.053	-25.4	-102.0	0.117	-18.6	40.3	1.103
0.80	0.167	-15.5	96.3	11.500	21.2	44.4	0.053	-25.6	-116.0	0.110	-19.2	17.6	1.114
0.90	0.169	-15.4	83.1	11.300	21.1	27.7	0.052	-25.6	-131.0	0.106	-19.5	-6.7	1.124
1.00	0.173	-15.2	68.8	11.200	21.0	11.0	0.052	-25.7	-145.0	0.102	-19.8	-30.1	1.138
1.10	0.177	-15.0	53.4	11.000	20.9	-5.6	0.051	-25.8	-159.0	0.101	-19.9	-52.4	1.150
1.20	0.177	-15.0	37.1	10.900	20.7	-22.2	0.050	-26.0	-174.0	0.100	-20.0	-76.0	1.170
1.30	0.179	-14.9	19.6	10.700	20.6	-39.0	0.049	-26.2	171.0	0.101	-19.9	-97.3	1.186
1.40	0.181	-14.9	0.5	10.600	20.5	-55.7	0.048	-26.3	156.0	0.103	-19.8	-117.0	1.205
1.50	0.181	-14.9	-19.2	10.400	20.4	-72.5	0.047	-26.5	142.0	0.105	-19.6	-136.0	1.227
1.60	0.182	-14.8	-40.2	10.200	20.2	-89.4	0.046	-26.7	127.0	0.107	-19.4	-154.0	1.255
1.70	0.186	-14.6	-63.3	10.100	20.1	-106.0	0.045	-26.9	112.0	0.109	-19.2	-169.0	1.280
1.80	0.190	-14.4	-87.6	9.920	19.9	-124.0	0.045	-27.0	97.0	0.113	-18.9	174.0	1.306
1.90	0.199	-14.0	-113.0	9.720	19.8	-141.0	0.044	-27.2	82.1	0.113	-18.9	160.0	1.338
2.00	0.215	-13.3	-138.0	9.510	19.6	-158.0	0.042	-27.5	66.8	0.117	-18.6	147.0	1.378
2.10	0.235	-12.6	-163.0	9.290	19.4	-176.0	0.041	-27.7	51.4	0.120	-18.4	135.0	1.416
2.20	0.260	-11.7	172.0	9.030	19.1	166.0	0.040	-28.0	35.4	0.124	-18.2	122.0	1.462
2.30	0.293	-10.7	147.0	8.740	18.8	149.0	0.038	-28.4	19.9	0.128	-17.8	112.0	1.518
2.40	0.329	-9.7	123.0	8.430	18.5	131.0	0.036	-28.8	3.6	0.137	-17.3	99.7	1.581
2.50	0.369	-8.7	99.9	8.090	18.2	113.0	0.035	-29.2	-12.9	0.143	-16.9	88.0	1.645
3.00	0.602	-4.4	-5.8	5.990	15.5	22.4	0.026	-31.9	-92.1	0.212	-13.5	24.4	2.073
3.50	0.779	-2.2	-96.4	3.830	11.7	-63.3	0.017	-35.4	-168.0	0.302	-10.4	-45.9	2.787
4.00	0.863	-1.3	-174.0	2.290	7.2	-141.0	0.011	-38.8	124.0	0.381	-8.4	-114.0	4.181
5.00	0.887	-1.1	52.5	0.838	-1.5	80.8	0.007	-42.6	-3.9	0.476	-6.4	121.0	13.380
6.00	0.887	-1.0	-69.8	0.353	-9.1	-45.3	0.007	-42.8	-129.0	0.500	-6.0	3.2	31.411
7.00	0.900	-0.9	173.0	0.159	-16.0	-168.0	0.008	-42.0	111.0	0.526	-5.6	-115.0	54.716
8.00	0.902	-0.9	61.0	0.075	-22.5	72.4	0.008	-41.5	-2.2	0.566	-5.0	131.0	99.527
9.00	0.888	-1.0	-47.5	0.038	-28.3	-49.7	0.009	-40.5	-117.0	0.585	-4.7	22.3	192.476
10.00	0.873	-1.2	-155.0	0.021	-33.5	-175.0	0.010	-40.0	128.0	0.584	-4.7	-88.3	375.167
11.00	0.870	-1.2	95.6	0.014	-37.3	54.6	0.010	-39.8	15.9	0.590	-4.6	159.0	572.555
12.00	0.878	-1.1	-13.8	0.009	-40.5	-75.5	0.009	-40.8	-99.3	0.619	-4.2	44.2	821.109
13.00	0.881	-1.1	-117.0	0.004	-48.3	143.0	0.005	-45.7	130.0	0.684	-3.3	-71.2	2981.617
14.00	0.877	-1.1	146.0	0.011	-39.5	103.0	0.009	-41.1	92.2	0.744	-2.6	180.0	557.304
15.00	0.860	-1.3	45.8	0.006	-44.6	-26.7	0.005	-45.5	-34.7	0.795	-2.0	68.4	1534.771
16.00	0.840	-1.5	-67.3	0.007	-42.8	-46.8	0.007	-43.0	-58.6	0.711	-3.0	-71.0	1428.991
17.00	0.849	-1.4	-178.0	0.013	-38.0	173.0	0.012	-38.3	161.0	0.560	-5.0	165.0	624.270
18.00	0.863	-1.3	86.1	0.013	-37.9	59.9	0.012	-38.2	46.2	0.528	-5.6	75.7	583.097
19.00	0.862	-1.3	-7.0	0.014	-37.0	-48.0	0.014	-37.3	-60.8	0.516	-5.8	-12.9	486.734
20.00	0.839	-1.5	-105.0	0.013	-37.8	-177.0	0.016	-36.0	165.0	0.463	-6.7	-117.0	574.400

## MGA-31716 Stability

$T_C = 25^\circ\text{C}$ ,  $V_d = 5.0\text{ V}$ ,  $I_d = 58\text{ mA}$ ,  $Z_o = 50\ \Omega$  (Data is de-embedded to the RFin & RFout pins. Measurements were made with Bias-T at Vd, Vctrl and Vbias in Figure 48)

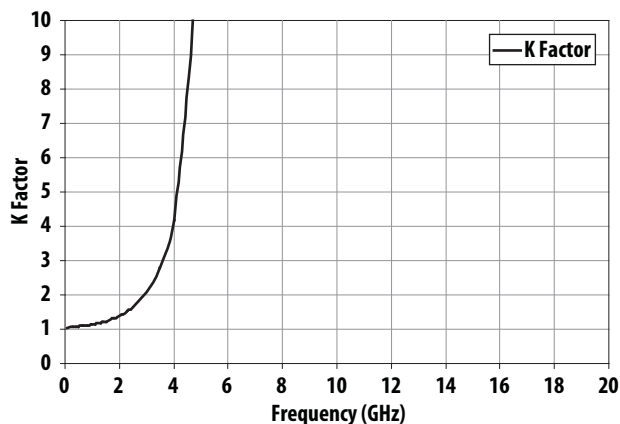

Figure 49. K-Factor vs Frequency

Table 5. MGA-31716 Typical Noise Parameters

$T_C = 25^\circ\text{C}$ ,  $V_d = 5.0\text{ V}$ ,  $I_d = 58\text{ mA}$ ,  $Z_o = 50\ \Omega$  (Data is de-embedded to the RFin & RFout pins on package. Measurements were made with Bias-Tees at Vd, Vctrl and Vbias in Figure 48)

Freq (GHz)	$F_{min}$ (dB)	$\Gamma_{opt}$ Mag	$\Gamma_{opt}$ Ang	$R_n/Z_0$	$G_a$ (dB)
0.5	1.46	0.159	-146.4	0.1272	21.43
0.8	1.55	0.120	-132.4	0.1384	21.22
0.9	1.60	0.105	-129.3	0.1440	21.13
1.0	1.63	0.097	-124.0	0.1546	21.10
1.5	1.74	0.043	-47.2	0.1972	20.43
2.0	1.92	0.168	36.3	0.2498	19.74
2.5	2.24	0.327	78.4	0.2862	18.89
3.0	2.52	0.544	109.3	0.3296	17.89
3.5	2.87	0.672	138.0	0.4130	18.56
4.0	3.38	0.781	159.6	0.5284	15.33
4.5	4.23	0.85	175.2	0.9124	13.18
5.0	5.12	0.881	-163.3	1.4458	11.13
5.5	6.54	0.919	-148.4	2.9438	7.73
6.0	7.84	0.916	-141.4	4.2160	5.92

## PCB Layout and Stencil Design

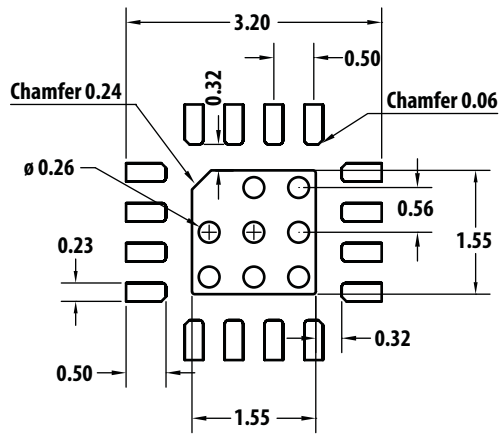

**PCB LAND PATTERN (TOP VIEW)**

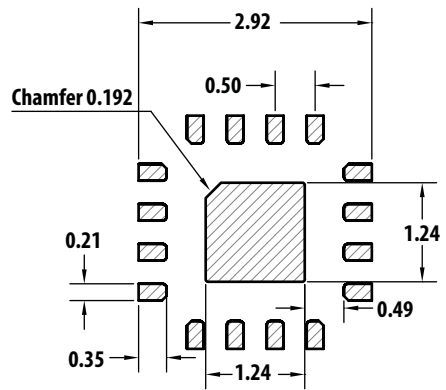

**STENCIL OUTLINE**

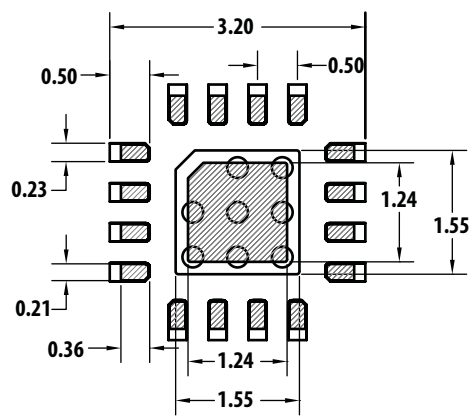

**COMBINED PCB & STENCIL LAYOUTS**

### Notes:

1. All dimensions are in millimeters
2. 4mil stencil thickness recommended



## Package Dimensions

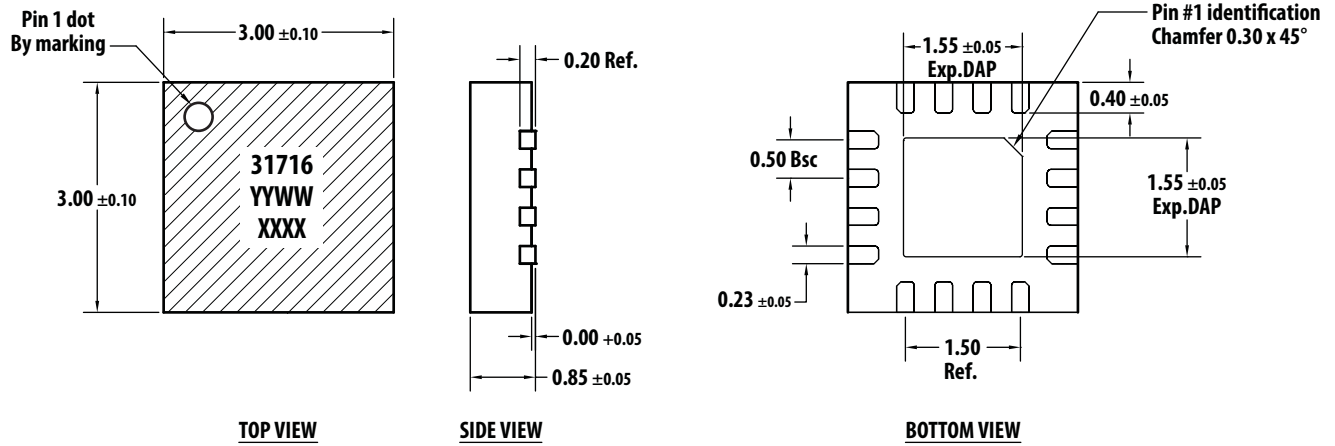

Notes:

1. All dimensions are in millimeters.
2. Dimensions are inclusive of plating.
3. Dimensions are exclusive of mold flash and metal burr.

## Part Number Ordering Information

Part Number	No. of Devices	Container
MGA-31716-BLKG	100	Antistatic Bag
MGA-31716-TR1G	3000	13" Tape/Reel

## Device Orientation

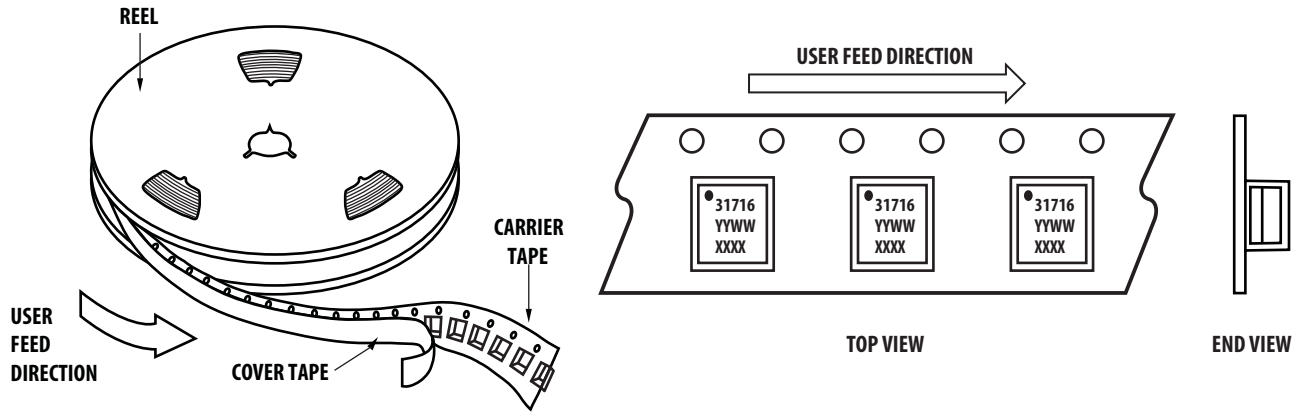

## Tape Dimensions

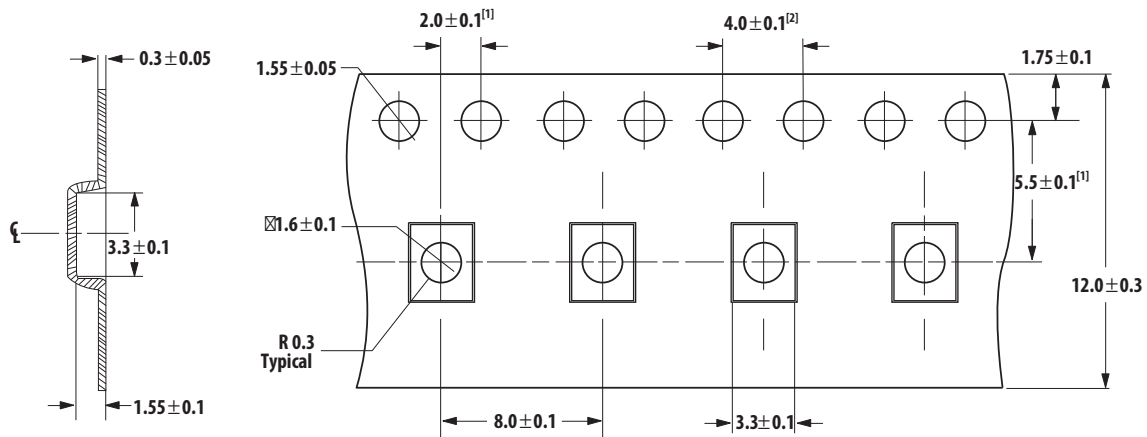

### Notes:

1. Measured from centerline of sprocket hole to centerline of pocket
2. Cumulative tolerance of 10 sprocket holes is ±0.20
3. Other material available
4. All dimensions in millimeter unless otherwise stated

# Reel Dimension – 13" Reel 12 mm Width

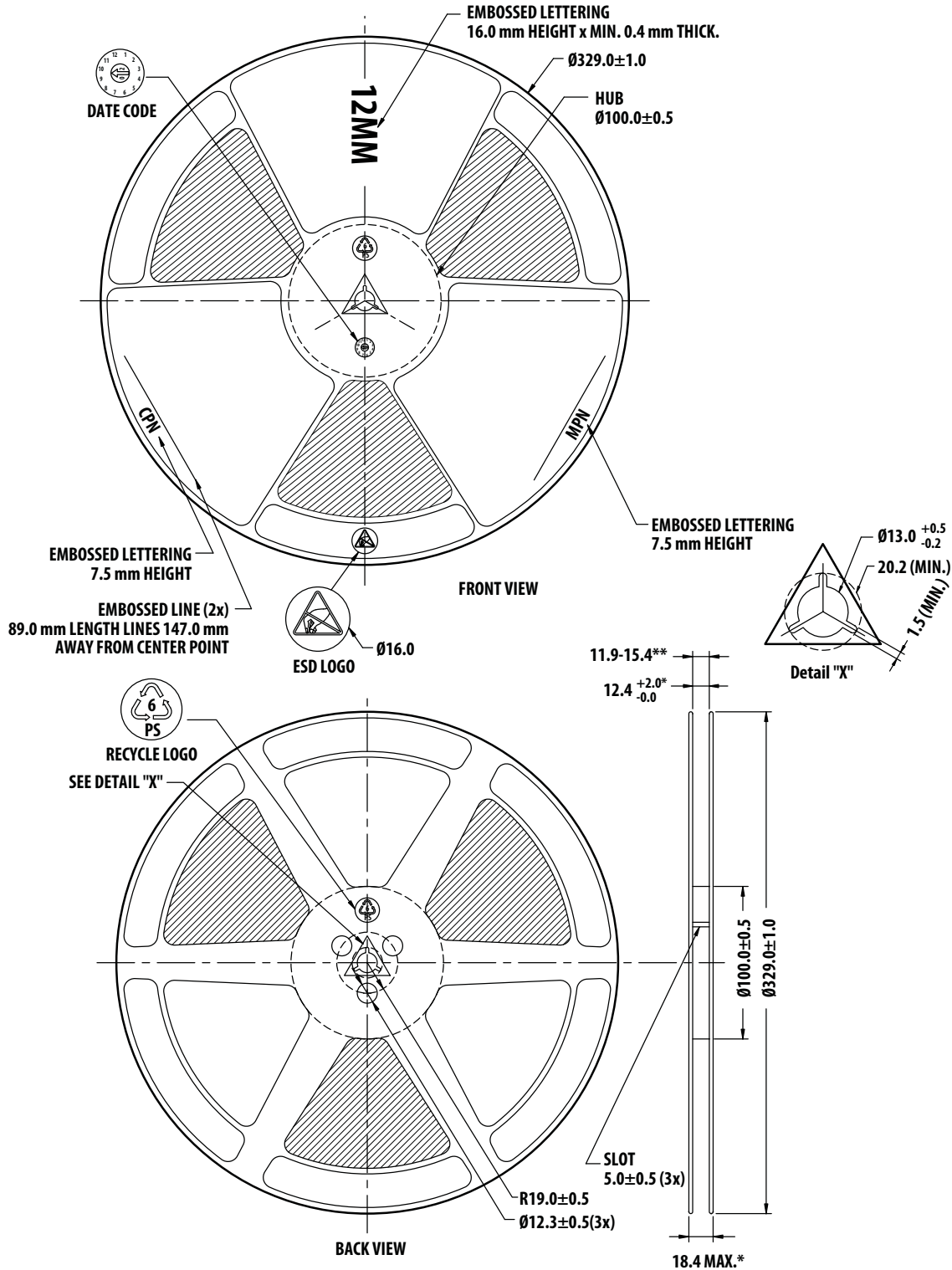

For product information and a complete list of distributors, please go to our web site: [www.avagotech.com](http://www.avagotech.com)

Avago Technologies and the A logo are trademarks of Avago Technologies in the United States and other countries. Data subject to change. Copyright © 2014-2016 Avago Technologies. All rights reserved. AV02-3264EN - April 29, 2016



## X-ON Electronics

Largest Supplier of Electrical and Electronic Components

*Click to view similar products for [Operational Amplifiers - Op Amps](#) category:*

*Click to view products by [Broadcom](#) manufacturer:*

Other Similar products are found below :

[OPA2991IDSGR](#) [OPA607IDCKT](#) [007614D](#) [633773R](#) [635798C](#) [635801A](#) [702115D](#) [709228FB](#) [741528D](#) [NCV33072ADR2G](#) [SC2903DR2G](#)  
[SC2903VDR2G](#) [LM258AYDT](#) [LM358SNG](#) [430227FB](#) [430228DB](#) [460932C](#) [AZV831KTR-G1](#) [409256CB](#) [430232AB](#) [LM2904DR2GH](#)  
[LM358YDT](#) [LT1678IS8](#) [042225DB](#) [058184EB](#) [070530X](#) [714228XB](#) [714846BB](#) [873836HB](#) [MIC918YC5-TR](#) [TS912BIYDT](#)  
[NCS2004MUTAG](#) [NCV33202DMR2G](#) [M38510/13101BPA](#) [NTE925](#) [SC2904DR2G](#) [SC358DR2G](#) [LM358EDR2G](#) [AZV358MTR-G1](#)  
[AP4310AUMTR-AG1](#) [HA1630D02MMEL-E](#) [NJM358CG-TE2](#) [HA1630S01LPEL-E](#) [LM324AWPT](#) [HA1630Q06TELL-E](#) [NJM4558CG-TE2](#)  
[AZV358MMTR-G1](#) [SCY33178DR2G](#) [NCS4325DR2G](#) [LM7301SN1T1G](#)